

DREHEN | TURNING

# DREHEN TURNING

**SCHWARZ Cuttingtools GmbH**  
Lembergstr. 33  
70825 Korntal-Münchingen, Germany  
Tel.: +49 (0) 711/51 87 88 10  
Fax: + 49 (0) 711/51 87 88 06  
[www.schwarz-cuttingtools.com](http://www.schwarz-cuttingtools.com)  
[info@schwarz-cuttingtools.com](mailto:info@schwarz-cuttingtools.com)

SCHWARZ Cuttingtools

# **SCHWARZ**

Zerspanungswerkzeuge  
Cuttingtools



# SCHWARZ

**SCHWARZ** ist ein Hersteller von hochpräzisen und langlebigen Zerspanungswerkzeugen. Namhafte Unternehmen der Automobilbranche sowie Unternehmen aus der Luft- und Raumfahrttechnik zählen zu unseren Kunden.

Wir möchten Ihnen unsere Qualität und Technologie näher bringen und stehen Ihnen gerne auch bei der Auswahl und Verwendung unserer Werkzeuge mit Rat und Tat zur Seite.

Unsere Werkzeuge werden nach DIN ISO 9001:2015 gefertigt und erfüllen somit alle Industriestandards. Wir entwickeln sie stetig weiter, damit wir unsere Kunden mit zeitgemäßen Arbeitsmitteln ausstatten können.

**SCHWARZ** garantiert Ihnen ausgezeichnete Qualität und hohe Standzeiten. Mit dem Kauf unserer Werkzeuge leisten Sie außerdem einen wertvollen Beitrag zum Schutz unserer Umwelt, da wir bei der Herstellung ausschließlich grüne, saubere Technologien einsetzen.

Wir freuen uns darauf, demnächst auch Sie von unserer Kompetenz überzeugen zu dürfen!

**SCHWARZ** is a producer of high-precision and long-lasting cutting tools. Among our customers, there are well-known companies from the automobile industry as well as such from the aerospace technology. We would like to present our quality and technology to you by providing technical support from the choice to the usage of our tools.

Our tools are produced in accordance with DIN ISO 9001:2015 and thereby all industry standards are fulfilled. Furthermore, they are always in development enabling us to meet our customer's contemporary needs.

**SCHWARZ** guarantees you an excellent quality and very high durability. Buying our tools also means to protect our environment through the exclusive use of clean and green technologies during the production process.

We look forward to an opportunity to convince you of our competence, too!

**Negative Drehplatten**  
*Negative Turning Inserts*



CN



DN



RN



SN



TN

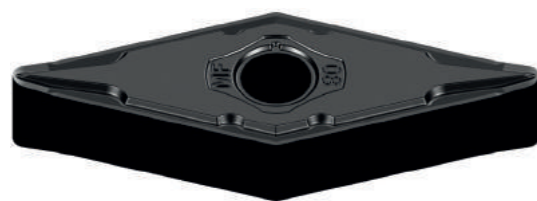

VN

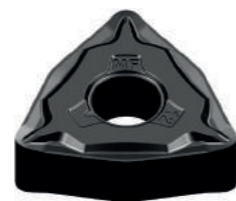

WN

**Positive Drehplatten**  
*Positive Turning Inserts*

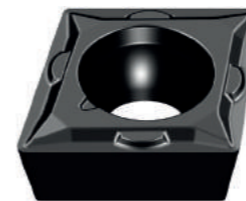

CC



DC



RC

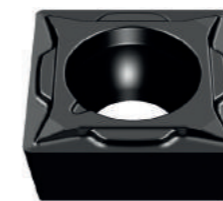

SC

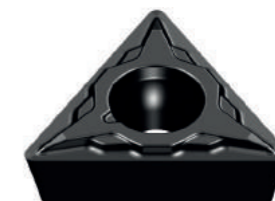

TC

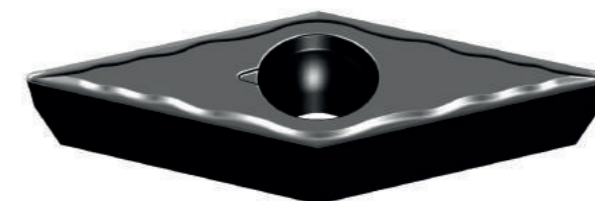

VB/VC

**Wie Sie die passende Drehplatte finden ..... 6**

**1 Beschichtungen und Spanbrecher ..... 11**

    Zusammensetzung der Beschichtungen ..... 12

    Anwendungsbereiche der Beschichtungen und Spanbrecher ..... 22

**2 Drehplatten ..... 29**

    Aufbau der Plattenbezeichnungen ..... 30

    Negative Drehplatten ..... 32

    Positive Drehplatten ..... 92

**3 Informationen zu Schnittdaten ..... 139**

    Schnittdatenberechnung ..... 140

    Informationen zu den Schnittdaten ..... 142

**4 Wettbewerbsvergleich ..... 149**

    Qualitätsvergleich ..... 150

    Spanbrechervergleich ..... 154

**5 Radsatzbearbeitung ..... 159**

    Wendeschneidplatten ..... 160

**6 Drehhalter und Bohrstangen ..... 167**

    Aufbau des Außendrehhalters ..... 168

    Außendrehhalter mit Innenkühlung ..... 170

    Außendrehhalter ..... 174

    Aufbau der Bohrstange ..... 192

    Bohrstangen ..... 194

**How To Find an Appropriate Turning Insert ..... 6**

**1 Turning Grades and Chipbreakers ..... 11**

    Composition of the Turning Grades ..... 12

    Application Range of Turning Grades and Chipbreakers ..... 22

**2 Turning Inserts ..... 29**

    Details of Insert Indications ..... 30

    Negative Turning Inserts ..... 32

    Positive Turning Inserts ..... 92

**3 Cutting Data Information ..... 139**

    Cutting Data Calculation ..... 140

    Details of Cutting Speed ..... 142

**4 Competitor Comparison ..... 149**

    Grades Comparison ..... 150

    Chipbreaker Comparison ..... 154

**5 Railway ..... 159**

    Grades Comparison ..... 160

**6 Holders and Boring Bars ..... 167**

    Details of External Holders Indications ..... 168

    External Holders with Coolant ..... 170

    External Holders ..... 174

    Details of Boring Bar Indications ..... 192

    Boring Bars ..... 194

1. Bestimmen Sie die Form der Drehplatte

Negative Drehplatten haben eine stabilere Schneide als positive und kommen daher besonders bei der schweren Werkstoffbearbeitung zum Einsatz. Außerdem können sie gewendet werden und besitzen daher doppelt so viele Schneiden wie positive Drehplatten. Positive Drehplatten eignen sich hingegen für die Bearbeitung von weicheren Werkstoffen mit geringen Zustellwerten.

Determine the shape of the turning insert

The edge of negative turning inserts are more stable than the positive ones, what makes them suitable especially for heavy machining. They have twice as much edges as positive turning inserts, as they can be turned over. However, positive turning inserts are suitable for the machining of soft material with lower feed values.

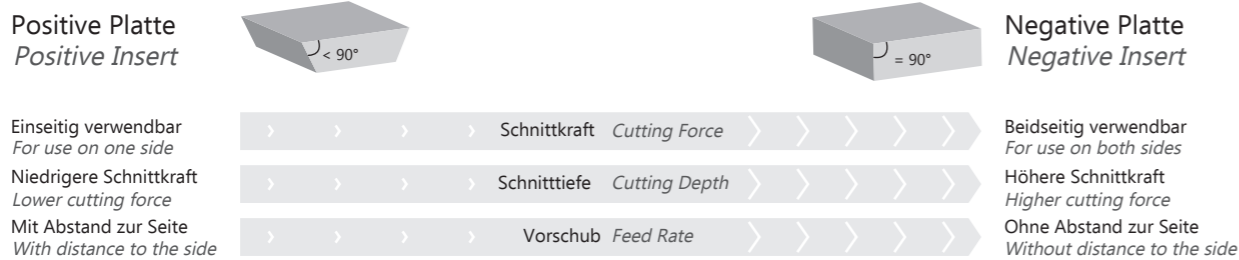

**Beispiel:** Sie wollen rostfreien Stahl bearbeiten und dabei mit hohen Zustellwerten arbeiten. Deshalb entscheiden Sie sich für eine negative Platte, z. B. CNMG120408 (Details zu den verschiedenen Plattenformen finden Sie auf Seite 30/31).

**Example:** You want to machine stainless steel using high feed values, so you choose a negative insert, e. g. CNMG120408 (for details of the different insert shapes see pages 30/31).

2. Bestimmen Sie die richtige Hartmetallqualität für den zu bearbeitenden Werkstoff

Wählen Sie ab Seite 140 eine beschichtete oder unbeschichtete Hartmetallqualität aus, die sich für Ihren Anwendungszweck eignet. Die dort angegebenen Schnittgeschwindigkeiten und die unten und rechts abgebildeten Informationen zu den Werkstoffgruppen bieten Ihnen für die Auswahl eine Orientierung. Eine genaue Beschreibung der einzelnen Beschichtungen finden Sie ab Seite 12.

Determine the appropriate solid carbide quality for the material type to be machined

Starting on page 140, choose a coated or uncoated solid carbide quality that is suitable for your application purpose. Use the given cutting speed data and the material type information below and on the right as orientation for your choice. A detailed description of the coatings can be found starting on page 12.

- P** Unlegierter, niedrig-, mittel- und hochlegierter Kohlenstoffstahl, legierter Stahl.  
*Unalloyed, low, medium and high alloyed carbon steel, alloyed steel.*
- M** Rostfreier Stahl, rostfreier Stahlguss, Stahlguss.  
*Stainless steel, stainless cast steel, cast steel.*
- K** Grauguss, Gusseisen mit Kugelgraphit, Temperguss.  
*Cast iron, cast iron with spheroidal graphite, heart fittings.*

- N** Aluminium und andere Nichteisenmetalle, Kupferlegierungen, Kunststoffe, Bronze, Messing.  
*Aluminium and other non-ferrous metals, copper alloys, plastics, bronze, brass.*
- S** Hitzebeständige Sonderlegierungen basierend auf Eisen, Nickel und Cobalt, Titan und Titanlegierungen.  
*Heat resistant special alloys based on iron, nickel and cobalt, titanium and titanium alloys.*

**Beispiel:** Der rostfreie Stahl, den Sie bearbeiten möchten, trägt die Bezeichnung 1.4571 und gehört zur Werkstoffgruppe M. Sie entscheiden sich für die Hartmetallqualität SW44125.

**Example:** The stainless steel you are going to machine is designated as 1.4571 and belongs to the M material group. As an appropriate solid carbide quality you choose SW44125.

3. Überprüfen Sie die gewählte Beschichtung und bestimmen Sie einen Spanbrecher

Die Schaubilder ab Seite 22 zeigen geeignete Beschichtungen für den kontinuierlichen bzw. unterbrochenen Schnitt sowie geeignete Spanbrecher für die leichte bis schwere Bearbeitung der Werkstoffe. Überprüfen Sie hier, ob Ihre gewählte Hartmetallqualität für Ihre individuellen Schnittbedingungen geeignet ist und wählen Sie ggf. eine passendere Beschichtung. Wählen Sie außerdem einen passenden Spanbrecher.

Check the chosen coating and determine a chip breaker

The charts starting on page 22 show suitable coatings for continuous and interrupted cutting as well as suitable chip breakers for finishing to roughing. Check here if your chosen solid carbide quality is suitable for your individual cutting conditions. If it is not, choose a more appropriate quality and a chip breaker.

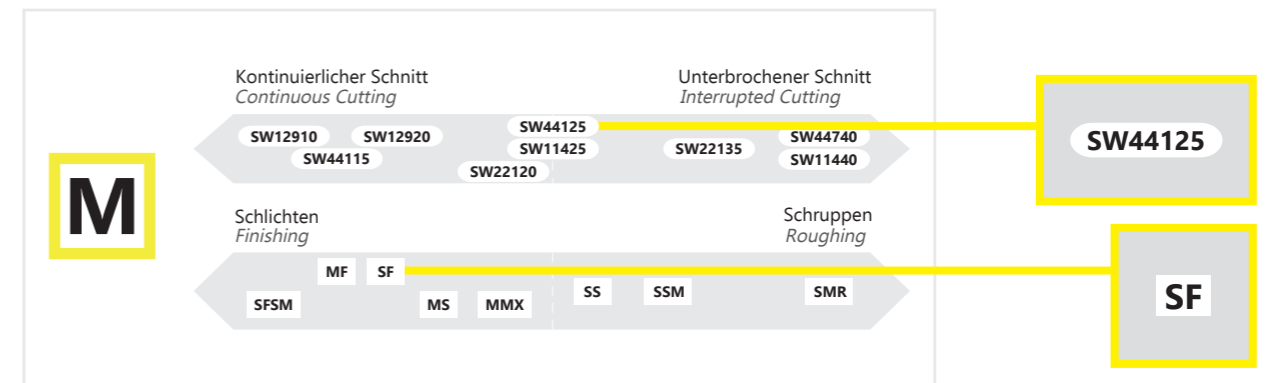

**Beispiel:** Für die Bearbeitung von 1.4571 unter gleichbleibenden Schnittbedingungen wählen Sie die Hartmetallqualität SW44125 und den Spanbrecher SF.

**Example:** For the machining of 1.4571 in continuous cutting conditions you choose the solid carbide quality SW44125 and the chip breaker SF.

4. Bestimmen Sie die Plattenmaße

Entnehmen Sie die technischen Daten immer auf der gegenüberliegenden Seite der Plattenauswahl, über welche Maße die Drehplatte für Ihren Anwendungszweck verfügen muss. Die benötigte Schnitttiefe (ap) und der Vorschub (fn) sind hierbei die relevanten Schnittdaten.

**Determine the insert dimensions**

Always refer to the technical data on the opposite side of the insert selection to determine the dimensions of the insert for your application. The required cutting depth (ap) and the feed (fn) are the relevant cutting data.

Bestellcode Ordering Code	Maße Dimensions (mm)				Schnittdaten Cutting Details			
	D	S	Re	d1	ap <sub>min</sub>	ap <sub>max</sub>	fn <sub>min</sub>	fn <sub>max</sub>
<b>CNMG 120404-SF</b>	12,700	4,76	0,40	5,16	0,60	3,00	0,10	0,23
<b>CNMG 120408-SF</b>	12,700	4,76	0,80	5,16	0,60	3,00	0,12	0,38
<b>CNMG 120412-SF</b>	12,700	4,76	1,20	5,16	0,60	3,00	0,15	0,55

**Beispiel:**

Sie haben ein ap-Maß von 1,8 mm zu schneiden, also wählen Sie die Platte CNMG 120404-SF mit einem fn-Wert von 0,16 mm pro Umdrehung. In vielen Fällen ist der Mittelwert ein guter Startwert.

**Example:**

You need to cut 1,8 mm deep, therefore you choose the insert CNMG 120404-SF with a feed value of 0,16 mm per rotation. In most cases the middle value is a good starting value.

5. Bestimmen Sie die Schnittgeschwindigkeit

Entnehmen Sie den Tabellen ab Seite 142 die Schnittgeschwindigkeit, die für Ihr Material und den individuellen Vorschub empfohlen wird.

**Determine the cutting speed**

Consult the tables starting on page 142 to find out the recommended cutting speed for your material and your individual feed.

		CVD-Beschichtung CVD Coating									
		Verschleißfestigkeit Wear Resistance						Zähigkeit Toughness			
		SW44115			SW22120			SW44125			
ISO	Material Material	fn (mm/rot) → HB (Brinell) ↓	0.2	0.4	0.6	0.2	0.4	0.6	0.2	0.4	0.6
M	Rostfreier Stahl, ferritisch/martensitisch Stainless Steel, ferritic/martensitic	200-330	125-260	100-220	80-200	130-200	80-170	60-150	100-230	70-175	50-135
	Rostfreier Stahl austenitisch Stainless Steel austenitic	180-330	130-290	100-240	80-190	130-200	80-170	60-150	100-240	70-175	55-130
	Rostfreier Stahl austenitisch-ferritisch (Duplex) Stainless Steel austenitic-ferritic (Duplex)	230-260	190-220	150-185	120-145	100-180	60-150	30-100	150-190	120-150	90-110

**Beispiel:**

Das Material 1.4571 gehört zur Werkstoffgruppe M und hat einen HB-Wert von 240. Bei einem fn-Wert von 0,16 mm/rot beträgt die optimale Schnittgeschwindigkeit 150-190 m/min.

**Example:**

Material 1.4571 belongs to the M material group and its HB value is 240. For a feed value of 0,16 mm/rot the optimal cutting speed is 150-190 m/min.

# 1

## BESCHICHTUNGEN UND SPANBRECHER *TURNING GRADES AND CHIPBREAKERS*

Informationen zur Zusammensetzung der Beschichtungen sowie zu den Anwendungsmöglichkeiten von Beschichtungen und Spanbrechern für die verschiedenen Werkstoffarten.

*Details of the coatings' composition as well as application ranges of the coatings and chip breakers for different material types.*

**CVD-Stahl Qualitäten****CVD-Steel-Grades****SW33105**  
P05-P15 **NEW**

Neue CVD-Beschichtung mit  $Al_2O_3 + TiN$  auf einem sehr harten Substrat. Erste Wahl für kontinuierlichen Schnitt ab einer Härte von mehr als 38HRC.

*New CVD coating with  $Al_2O_3 + TiN$  combined with a very hard substrate. First choice of continuous cutting with a hardness higher than 38HRC.*

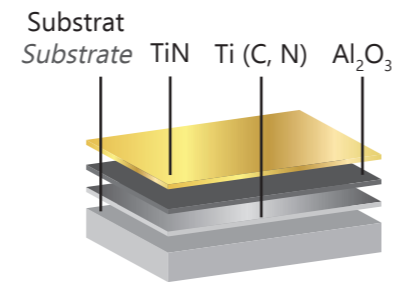
**SW22115**  
P10-P25

CVD-Beschichtung mit  $Ti (C, N) - Al_2O_3$  für mittlere Temperaturen. Hartmetallsorte mit Gradientenschicht dicht an der Oberfläche. Geeignet für schnelle bis mittlere Schnittgeschwindigkeiten auf Stahl und Stahlguss.

*Medium temperature CVD coating with  $Ti (C, N) - Al_2O_3$ . Carbide grade with a gradient layer close to the surface. Suitable for high to medium cutting speeds on steels and cast steels.*

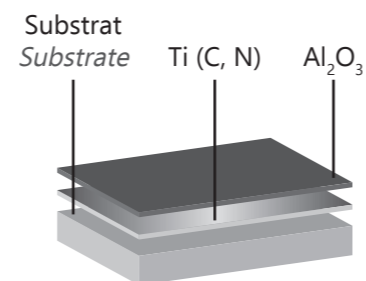
**SW33115**  
P10-P25 **NEW****SW33115 ersetzt die Qualität SW22115.**

Neue CVD-Beschichtung mit  $Al_2O_3 + TiN$ . Geeignet für mittlere bis hohe Schnittgeschwindigkeiten von Stählen.

**SW33115 is replacing the grade SW22115.**

*New CVD Coating with  $Al_2O_3 + TiN$ . Suitable for medium to high cutting speed in steel.*

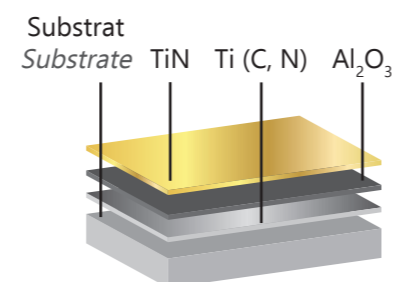
**SW22125**  
P10-P35

Hartmetall für die mittlere Bearbeitung von Stahl und Stahlguss bei mittleren Schnittgeschwindigkeiten. Auf diesem Hartmetall haftet die Aluminiumbeschichtung ( $Al_2O_3$ ) bereits bei mittleren CVD-Temperaturen, was die Standzeit des Werkzeugs erhöht.

*Carbide grade suitable for medium machining of steels and cast steels at medium cutting speeds. The substrate is suitable for the adhesion of the aluminium coating ( $Al_2O_3$ ) at medium CVD temperature, which improves the tool's life.*

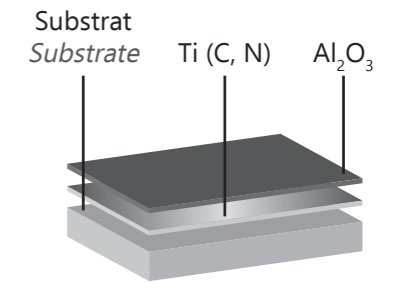
**SW33125**  
P20-P30 **NEW****SW33125 ersetzt die Qualität SW22125.**

Neue Hartmetallsorte geeignet für die mittlere Bearbeitung von Stählen bei mittleren Schnittgeschwindigkeiten. Ideal für die meisten Anwendungen in allen Stählen.

**SW33125 is replacing the grade SW22125.**

*New carbide grade which is suitable for medium machining of steels at medium cutting speeds. Ideal for general applications in all kinds of steel.*

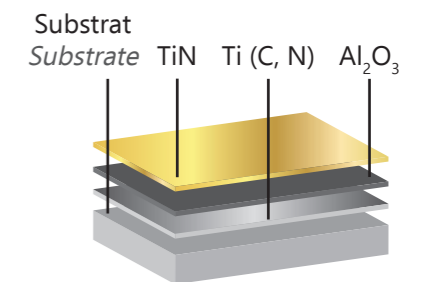



**SW22740**

P25-P45 K20-K40

Substrat mit mittlerer Körnung, bei mittlerer Temperatur im CVD-Verfahren zusammengesetzt. Geeignet für schwere bis normale Schruppbearbeitung mit unterbrochenem Schnitt bei mittleren bis niedrige Schnittgeschwindigkeiten.

*Carbide grade with medium grain size combined with medium temperature CVD coating. Suitable for heavy roughing to roughing operations with interrupted cuts at medium to low cutting speeds.*

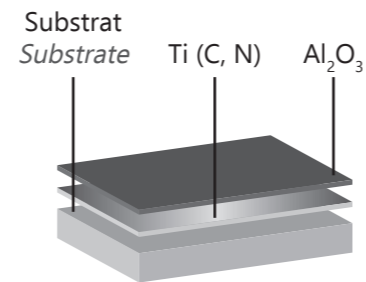
**SW33740**

P25-P45

NEW

**SW33740 ersetzt die Qualität SW22740.**

Neue zähe Hartmetallsorte mit mittlerer Korngröße, bei mittlerer Temperatur im CVD-Verfahren zusammengesetzt. Erste Wahl für die normale bis schwere Schruppbearbeitung mit unterbrochenem Schnitt bei mittleren bis niedrigen Schnittgeschwindigkeiten.

**SW33740 is replacing the grade SW22740.**

*New carbide grade with medium grain size combined with medium temperature CVD coating. First choice for roughing to heavy duty roughing operations with interrupted cuts at low cutting speeds.*

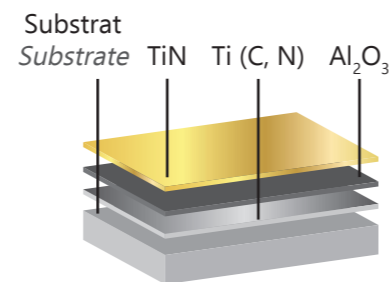
**CVD-Edelstahl Qualitäten****CVD-Stainless Steel-Grades****SW44115**

M10-M25

NEW

Neue CVD-Beschichtung mit TiCN+Al<sub>2</sub>O<sub>3</sub>+TiC. Geeignet für mittlere bis hohe Schnittgeschwindigkeiten in Edelstählen. Ideal für gute Schnittbedingungen (kontinuierlicher Schnitt).

*New CVD coating with TiCN+Al<sub>2</sub>O<sub>3</sub>+TiC. Suitable for medium to high cutting speeds in stainless steel. Ideal for good cutting conditions (continuous cut).*

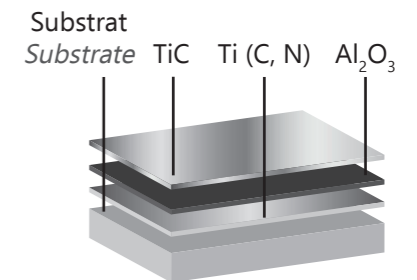
**SW22120**

M10-M25

Diese Drehsorte eignet sich hervorragend für austenitische Stähle, die mit hohen Schnittgeschwindigkeiten von bis zu 170 – 220 m/min zerspannt werden können.

*This turning grade is excellent for machining austenitic steels with high cutting speeds up to 170 - 220 m/min.*

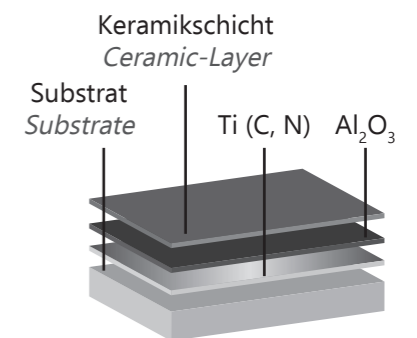

**SW44125**  
M15-M30 **NEW**

Neue CVD-Beschichtung mit TiCN+Al<sub>2</sub>O<sub>3</sub>+TiC. Neue Hartmetallsorte für die mittlere Bearbeitung von Edelstählen bei mittleren Schnittgeschwindigkeiten. Alternativ kann sie auch in Superlegierungen eingesetzt werden. Erste Wahl für die meisten Anwendungen in Edelstählen.

*New CVD coating with TiCN+Al<sub>2</sub>O<sub>3</sub>+TiC. New Carbide grade suitable for medium machining of stainless steels at medium cutting speeds. Alternatively, it can be used in super alloys. First choice for general application on turning of stainless steels.*

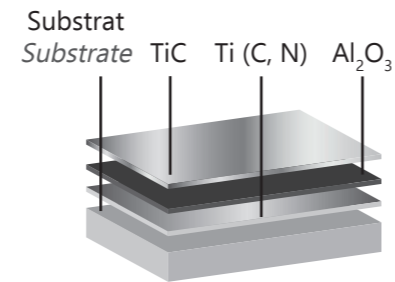

**SW22135**  
M25-M40

CVD-Beschichtung mit zähem Substrat für die Bearbeitung von Edelstählen. Dabei sind mittlere bis hohe Schnittgeschwindigkeiten zu empfehlen.

*CVD coating with a very tough substrate for machining of stainless steel. For best results we recommend medium to high cutting speeds.*

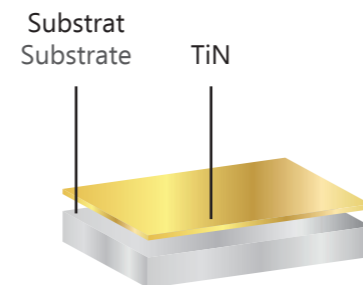

**SW44740**  
M25-M45 **NEW**

Neue CVD-Beschichtung mit TiCN+Al<sub>2</sub>O<sub>3</sub>+TiC. Erste Wahl für die normale bis schwere Schruppbearbeitung mit unterbrochenem Schnitt bei mittleren bis niedrigen Schnittgeschwindigkeiten in Edelstählen.

*New CVD coating with TiCN+Al<sub>2</sub>O<sub>3</sub>+TiC. First choice for roughing to heavy roughing operations with interrupted cut at medium to low cutting speeds on stainless steel.*

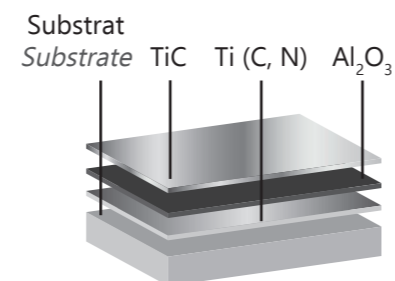

**CVD-Guss Qualitäten**  
**CVD-Stainless Cast-Iron**

**SW22705**  
K05-K15

Das Substrat hat eine hohe Verschleißfestigkeit und ist MT-CVD-beschichtet. Dies erlaubt den Einsatz bei hohen bis mittleren Schnittgeschwindigkeiten unter gleichbleibenden Bedingungen. Empfohlen für die Bearbeitung von Grauguss oder gehärtetem Stahl.

*The substrate grade with a very good wear resistance combined with the MT-CVD coating allows to work at high to medium cutting speeds at stable conditions. Recommended for turning of grey cast iron or hardened steels.*

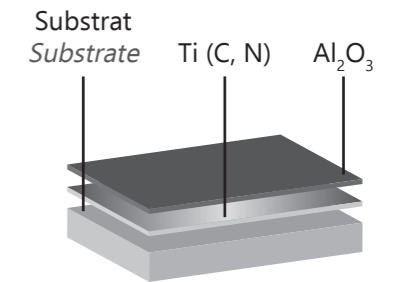

**SW22320**  
K10-K25

CVD-Beschichtung bei mittlerer Temperatur und ein hartes Substrat sorgen für Widerstandskraft bei unterbrochenem Schnitt. Empfohlen zum Schruppen aller Gusseisen bei niedrigen bis mittlere Schnittgeschwindigkeiten.

*Medium temperature CVD coating combined with a hard substrate make it capable of withstanding interrupted conditions. Recommended as general choice for roughing of all cast irons at low to medium cutting speeds.*

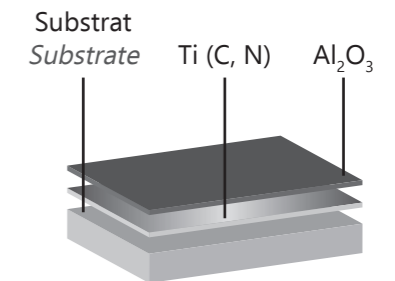

**CVD-Superlegierungs Qualitäten**  
**CVD-Super-Alloys-Grades**

**SW22410**  
**M05-M15 S05-S10**

Diese Beschichtung eignet sich bestens für die Anwendungen in Titan, dank seines temperaturresistenten Hartmetalls und TiBN-Plasmabeschichtung.

*This grade is the first choice for applications in titanium due to its temperature resistant carbide and TiBN-plasma-coating.*

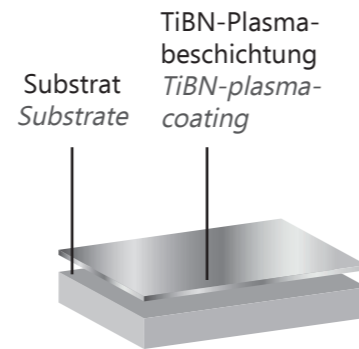

**PVD-Edelstahl Qualitäten**  
**PVD-Stainless Steel-Grades**

**SW12910**  
**P05-P10 M05-M10 S05-S15**

PVD beschichtetes (AlTiN) Hartmetallsubstrat mit sehr harter Körnung für die leichte Bearbeitung von Stahl, gehärtetem Stahl und Edelstahl.

*PVD coated (AlTiN) carbide grade with a very hard micro grain substrate for light turning of steels, hardened steels and stainless steels.*

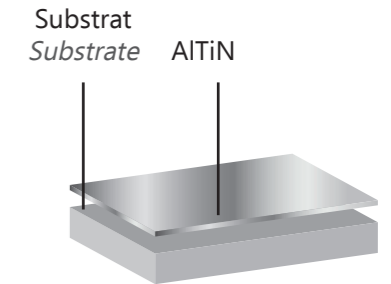

**SW12920**  
**M10-M25 S10-S30**

Fortschrittliche PVD-AlTiN-Beschichtung auf harter, verschleißfester Ultra-Feinstkorn-Qualität für die allgemeine Bearbeitung von gehärtetem Edelstahl und Superlegierungen.

*An advanced PVD AlTiN coated grade over a tough and wear resistant sub-micro substrate for general purpose machining of hardened stainless steels and super alloys.*

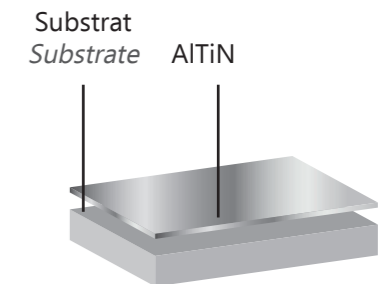

**SW11425**  
**M15-M30**

Benutzen Sie diese Beschichtung bei mittleren bis hohen Schnittgeschwindigkeiten um austenitische rostfreie Edelmstähle zu zerspanen.

*We recommend to use this grade to machine austenitic stainless steels at medium to high cutting speeds.*

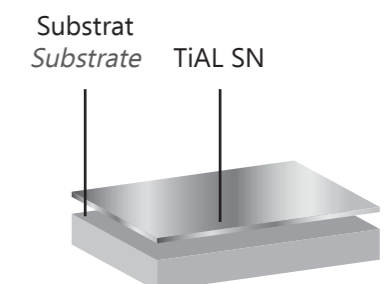

**SW11440**  
**M30-M45 S30-S40**

Eine sehr zähe Sorte für Edelmstähle bei unterbrochenem Schnitt bei niedrigen Schnittgeschwindigkeiten.

*A very tough grade for stainless steels with interrupted cuts at low cutting speeds.*

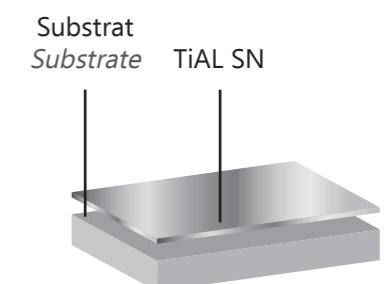



## PVD-Superlegierungs Qualitäten

### PVD-Super-Alloys-Grades

#### SW11415

##### S10-S20

Diese spezielle Feinstkornsorte ist vorrangig für die Anwendung in Superlegierungen wie Inconel, Titan, etc. geeignet.

*This special submicron grade has its priority application in machining Inconel and Titanium a.s.o.*

#### SW11515

##### S05-S20

Die Feinstkornsorte wird vor allem bei Materialien wie Titan, Edelstahl und Inconel eingesetzt. Aufgrund seiner dünnen PVD-Beschichtung findet diese Sorte vorwiegend Anwendung, wo kleine bis sehr kleine Teile hergestellt werden müssen, wie z. B. in der Medizintechnik oder Uhrenindustrie.

*The submicron grade should be used in materials such like titanium, stainless steels and Inconel. Due to its thin PVD-coating this grade allows the production of small and very small parts, for example like in medical engineering or in the watchmaking industry.*

#### SW11420

##### S10-S25

Unsere Beschichtung SW11420 ist eine zähere Alternative zu SW11415 und für die Bearbeitung von Superlegierungen wie Inconel, Waspaloy, Hastelloy etc. geeignet.

*Our coating SW11420 is a tougher alternative for SW11415. It works excellent when machining super alloys such as Inconel, Waspaloy, Hastelloy a.s.o.*

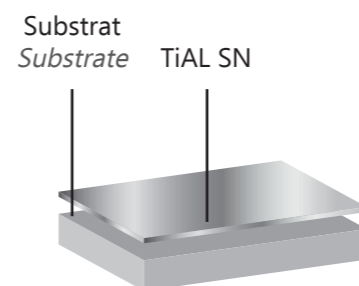
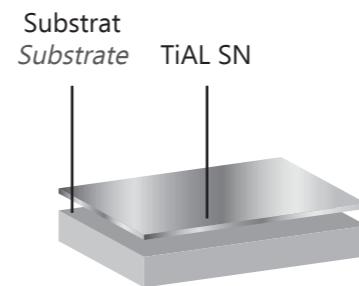
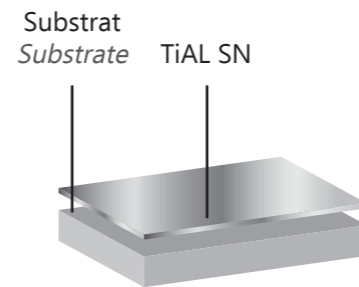

## PVD-Nichteisenmetall Qualitäten

### PVD-Non-Ferrous-Grades

#### SW11610

##### N05-N20

Für die Bearbeitung von Aluminium und anderer Nichteisenmetalle empfehlen wir unsere fortschrittliche Beschichtung SW11610. Die extra dünn aufgetragene spezielle Plasma-PVD-TiAlN-Schicht verhindert das Aufkleben und sorgt für eine perfekte Oberfläche. Neben der außerordentlichen Zerspanungsleistung von NE-Metallen, kann diese Drehsorte auch für das Schlichten von Edelstählen und Grauguss eingesetzt werden.

*For machining aluminum and other non-ferrous metals, we recommend our advanced coating SW11610. The extra thin special plasma-PVD-TiAlN-layer prevents the adhesive bonding and takes care to reach a perfect surface finish. This grade is also excellent to finish stainless steels and grey cast iron.*

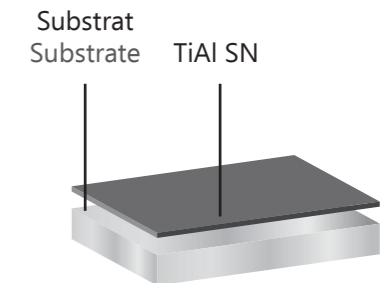

## Unbeschichtete Qualitäten

### Uncoated Grades

#### SW00610

##### N05-N15

Diese Drehsorte ist besonders verschleißfest. Diese Eigenschaft erlaubt es, Nichteisenmetalle, Aluminiumlegierungen und andere kurzspanende Werkstoffe unter ungünstigen Bedingungen bei mittleren und hohen Schnittgeschwindigkeiten zu zerspanen.

*This turning grade is especially wear resistant. This fact allows to machine non-ferrous metals, aluminum alloys and other short chipping materials under unfavorable conditions with medium to high cutting speeds.*

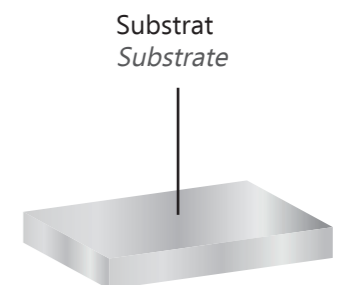

#### SW00910

##### N05-N15

Unbeschichtete Feinstkornhartmetallsorte geeignet für die Bearbeitung von Aluminium und anderen Nichteisenmetalle.

*Uncoated carbide micrograin grade suitable for machining aluminium and other non-ferrous metals.*

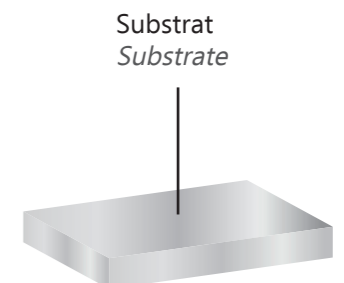

Geeignete Beschichtungen für verschiedene Werkstoffarten  
Suitable Turning Grades for Specific Material Types

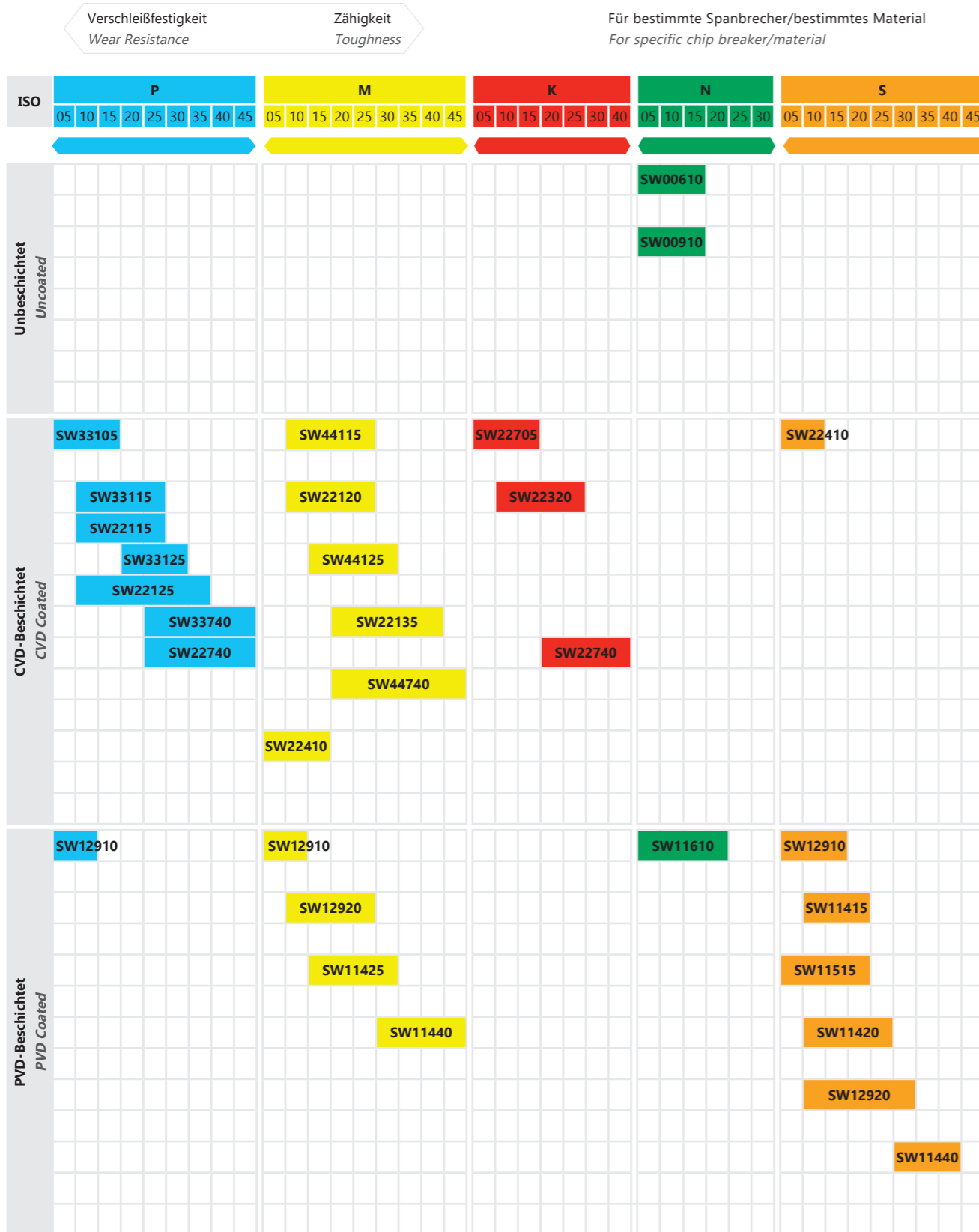

Anwendungsbereich der negativen Drehplatten  
Application Range of Negative Turning Inserts

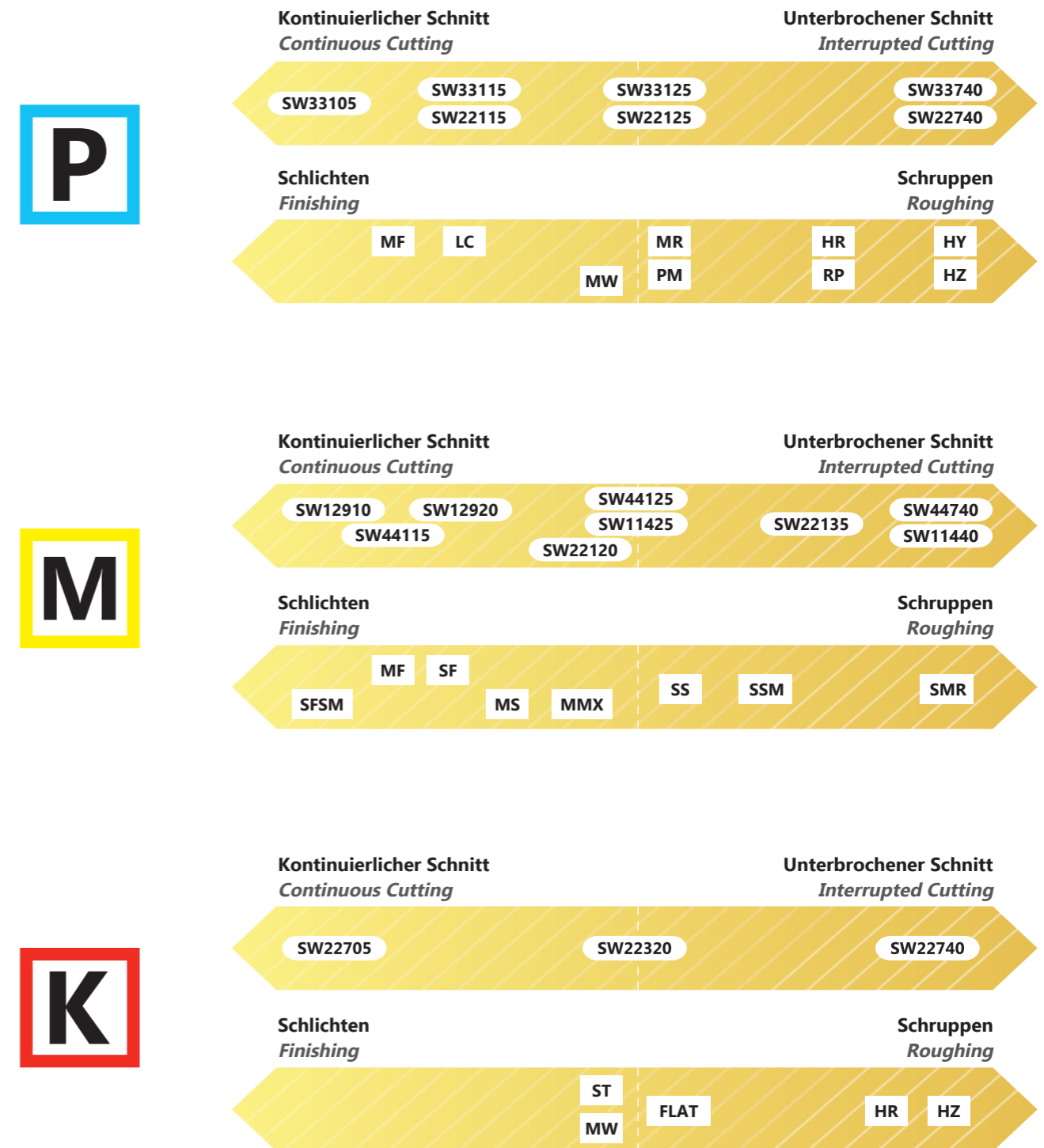

Anwendungsbereich der negativen Drehplatten  
Application Range of Negative Turning Inserts

**N**

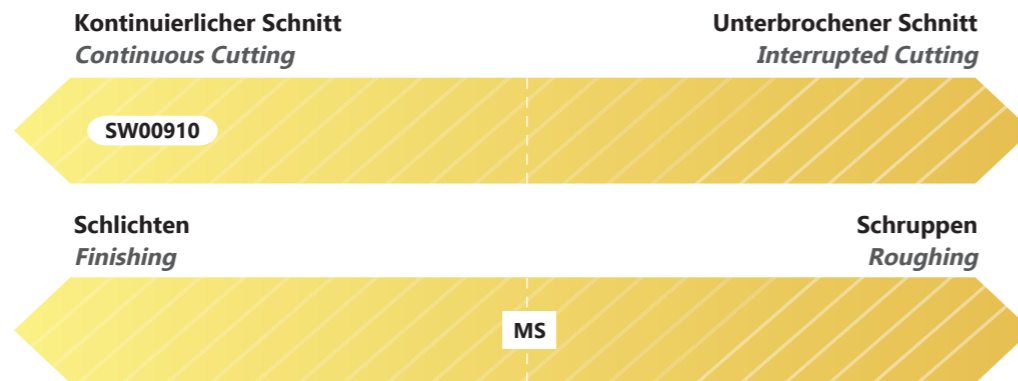

**S**

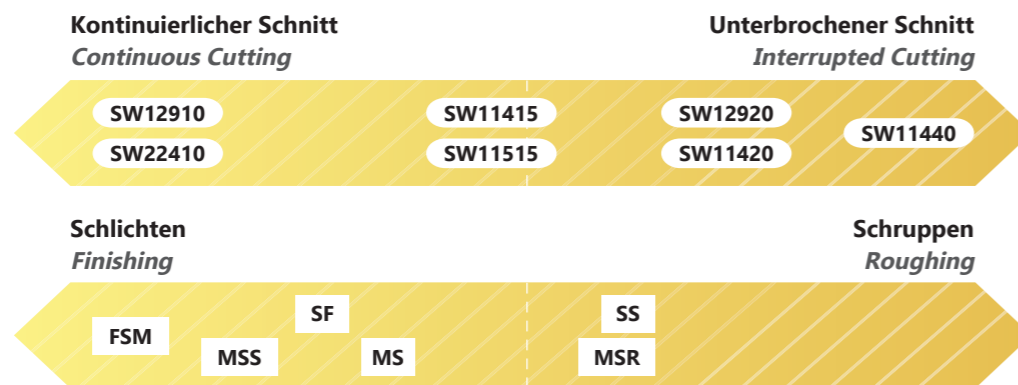

Anwendungsbereich der positiven Drehplatten  
Application Range of Positive Turning Inserts

**P**

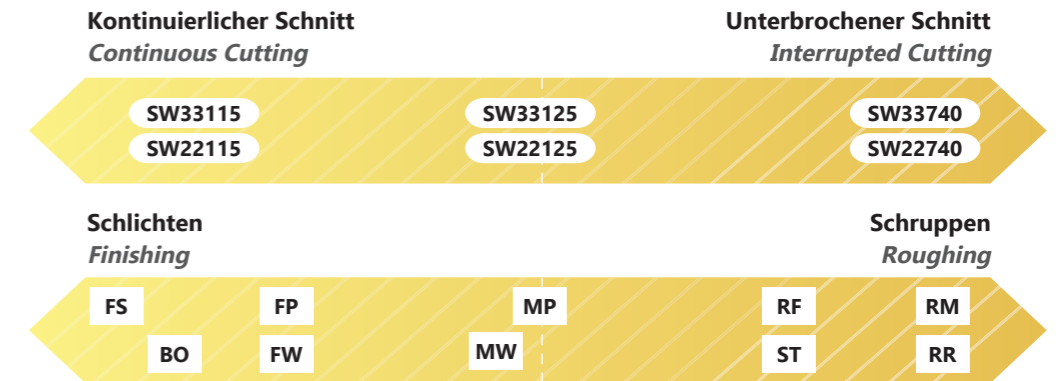

**M**

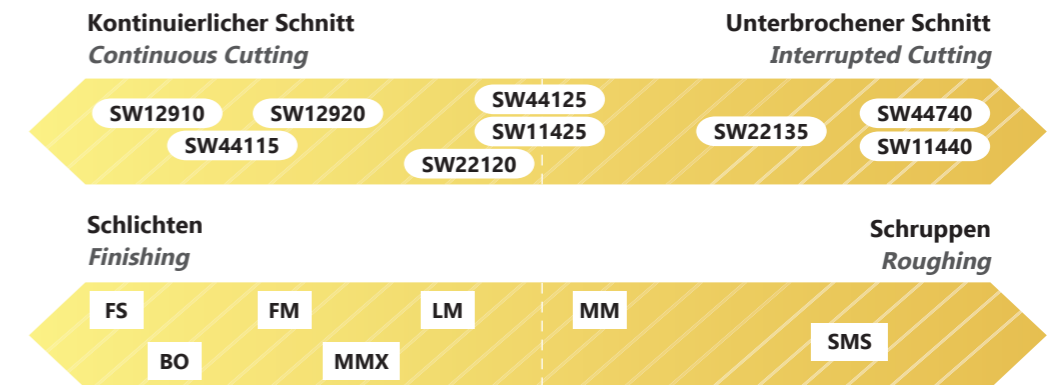

**K**

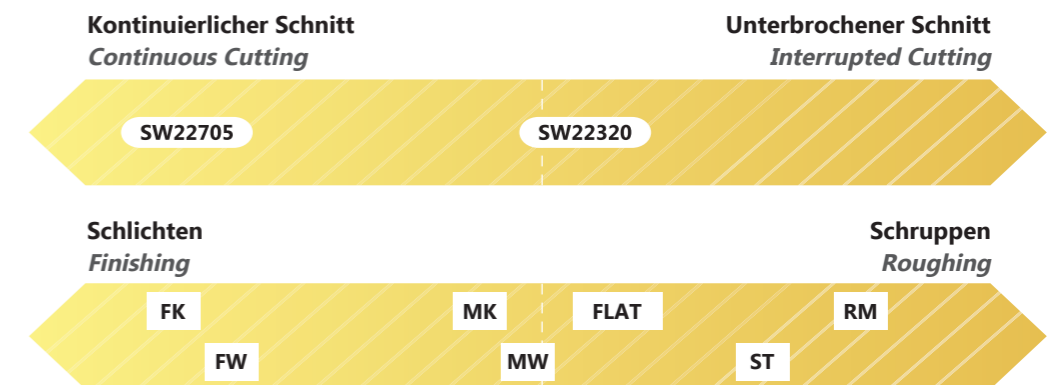



Anwendungsbereich der positiven Drehplatten  
*Application Range of Positive Turning Inserts*

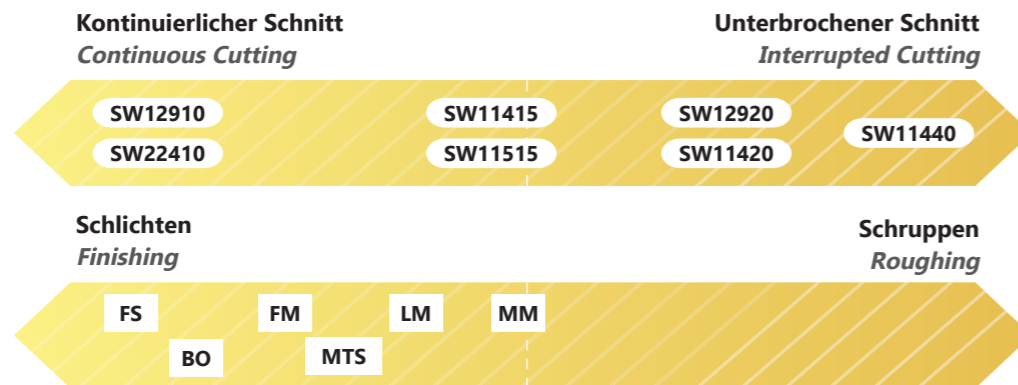
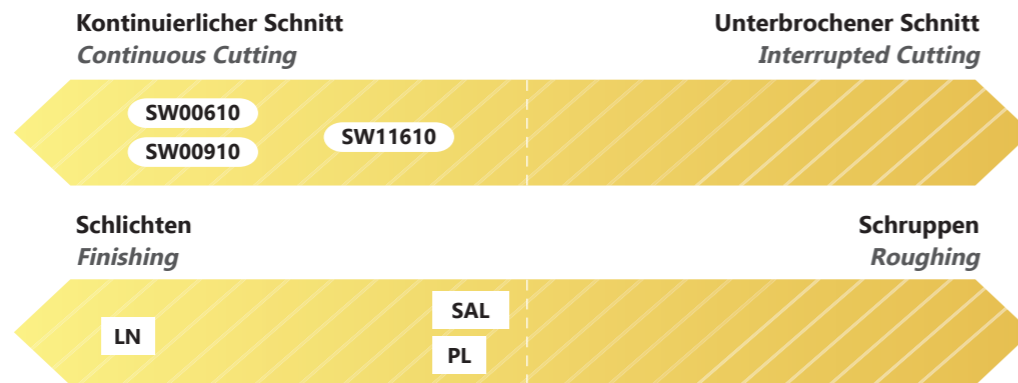

# 2

## DREHPLATTEN TURNING INSERTS

Erläuterung der Plattenbezeichnungen,  
Lagerhaltigkeit der Produkte und  
Empfehlungen für die Bearbeitung  
verschiedenener Werkstoffarten.

*Details of insert indications,  
stock availability of products and  
recommandations for the machining  
of various material types.*



1. Plattenform *Insert Shape*

V	W	S	T	C	D	R
35°	80°	90°	60°	80°	55°	-

2. Freiwinkel *Normal Clearance Angle*

B	C	N
5°	7°	0°

3. Toleranzen *Tolerances*

	G	M
m (mm)	± 0,025	± 0,08 ~ ± 0,18
d (mm)	± 0,025	± 0,05 ~ ± 0,13
s (mm)	± 0,13	± 0,13

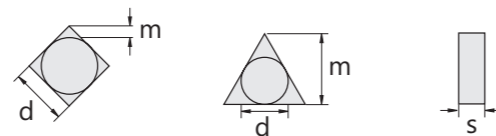

4. Spanbrecher-Typ/Fixierung *Type of Chip Breaker/Clamping*

	W	T	M	G
<b>Lochtyp</b> <i>Type of Hole</i>	rundes Loch/eine Senkung (40°~60°) <i>round hole/one countersink (40°~60°)</i>		rundes Loch <i>round hole</i>	
<b>Spanbrecher</b> <i>Chip Breaker</i>	ohne Spanbrecher <i>without chip breaker</i>		einseitiger Spanbrecher <i>chip breaker on one side</i>	beidseitiger Spanbrecher <i>chip breaker on both sides</i>
<b>Form</b> <i>Shape</i>				



5. Plattengröße *Insert Size*

Ø IC (mm)	V	W	S	T	C	D	R
	35°	80°	90°	60°	80°	55°	-
6,0	-	-	-	-	-	-	06
6,35	11	04	06	11	06	07	06
8,0	-	-	-	-	-	-	08
9,525	16	06	09	16	09	11	09
10,0	-	-	-	-	-	-	10
12,0	-	-	-	-	-	-	12
12,7	22	08	12	22	12	15	12
15,875	27	10	15	27	16	19	15
16,0	-	-	-	-	-	-	16
19,05	33	13	19	33	19	23	19
20,0	-	-	-	-	-	-	20
25,0	-	-	-	-	-	-	25
25,4	44	17	25	44	25	31	25

Gemäß ISO 1832:2012 »Wendeplatten zur Zerspanung – Bezeichnung«.  
According to ISO 1832:2012 »Indexable inserts for cutting tools – Designation«.

6. Plattenstärke *Insert Thickness*

ISO	02	03	T3	04	05	06	07	09
mm	2,38	3,18	3,97	4,76	5,56	6,35	7,94	9,52

7. Eckenradius *Nose Radius*

ISO	M0	02	04	08	12	16	24	M0 metrisch M0 metric
mm	spitzer Eckenradius <i>sharp nose</i>	0,2	0,4	0,8	1,2	1,6	2,4	runde Platte <i>round insert</i>





CNMG

▲ empfohlene Qualität (auf Lager) **●** alternative Qualität (auf Lager) ■ Auslaufmodell (auf Lager bis ausverkauft)  
*recommended grade (on stock) alternative grade (on stock) discontinued model (in stock until sold out)*

Bestellcode Ordering Code	Qualität   Grades																								
	P							M								K	N	S							
	SW33105	SW22115	SW33115	SW22125	SW33125	SW22740	SW33740	SW12910	SW44115	SW12920	SW22120	SW44125	SW11425	SW22135	SW44740	SW11440	SW22705	SW22320	SW00910	SW12910	SW22410	SW11415	SW11515	SW12920	SW11420

CNMG-MF



Schlichten  
Finishing

	1	2	3	4	5	6	7	8	9	10	11	12	13	14	15	16	17	18	19	20	21	22	23	24	25
CNMG 090304-MF	▲	▲	▲	▲	●																				
CNMG 090308-MF	▲	▲	▲	▲	●																				
CNMG 09T304-MF	▲	▲																							
CNMG 09T308-MF	▲	▲																							
CNMG 120404-MF	●	▲	▲	▲	●		▲																		
CNMG 120408-MF	▲	▲	▲	▲	●		▲																		
CNMG 120412-MF	▲	▲	▲	▲	●																				

CNMG-SFSM



Schlichten  
Finishing

	1	2	3	4	5	6	7	8	9	10	11	12	13	14	15	16	17	18	19	20	21	22	23	24	25
CNMG 090304-SFSM											▲		▲	▲											
CNMG 120404-SFSM											▲		▲	▲											
CNMG 120408-SFSM											▲		▲	▲											
CNMG 120412-SFSM											▲		▲	▲											

NEW

CNMG-SF



Mittlere Bearbeitung  
bis Schlichten  
Medium to Finishing

	1	2	3	4	5	6	7	8	9	10	11	12	13	14	15	16	17	18	19	20	21	22	23	24	25
CNMG 120404-SF								●	▲	●		●								●				▲	
CNMG 120408-SF								●	▲	●		●								●				▲	
CNMG 120412-SF								●	▲	●		●								●				▲	

CNMG-LC



Mittlere Bearbeitung  
bis Schlichten  
Medium to Finishing

	1	2	3	4	5	6	7	8	9	10	11	12	13	14	15	16	17	18	19	20	21	22	23	24	25
CNMG 120404-LC		▲	▲	▲	●																				
CNMG 120408-LC	●	●	▲	▲	●																				
CNMG 120412-LC		▲	▲	▲	●																				



Ersetzt alte Qualität in neue Qualität. SW22115 wird durch SW33115 ersetzt. SW22125 wird durch SW33125 ersetzt. SW22740 wird durch SW33740 ersetzt.  
*Replaces old grade into new grade. SW22115 is replaced by SW33115. SW22125 is replaced by SW33125. SW22740 is replaced by SW33740.*

Wettbewerbs-Qualitätsvergleich siehe Seite 150-152. *Competitor grade comparison see pages 150-152.* →  
 Wettbewerbs-Spanbrechervergleich siehe Seite 154-157. *Competitor chipbreaker comparison see pages 154-157.* →

CNMG

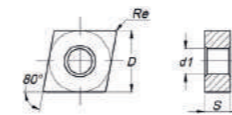

Maße Dimensions (mm)				Schnittdaten Cutting Details				Preis in €   Price in €																								
D	S	Re	d1	ap min	ap max	fn min	fn max	SW33105	SW22115	SW33115	SW22125	SW33125	SW33740	SW12910	SW44115	SW12920	SW22120	SW44125	SW11425	SW22135	SW12910	SW22410	SW11415	SW11515	SW12920	SW11420						
								1	2	3	4	5	7	8	9	10	11	12	13	14	20	21	22	23	24	25						
9,525	3,18	0,40	3,81	0,10	1,50	0,05	0,25		6,65	7,68	6,65	7,68																				
9,525	3,18	0,80	3,81	0,10	1,50	0,10	0,40		6,65	7,68	6,65	7,68																				
9,525	3,97	0,40	3,81	0,10	1,50	0,05	0,25		6,65	7,68																						
9,525	3,97	0,80	3,81	0,10	1,50	0,10	0,40		6,65	7,68																						
12,700	4,76	0,40	5,16	0,10	1,50	0,05	0,25	8,87		8,87	7,73	8,87		7,73																		
12,700	4,76	0,80	5,16	0,10	1,50	0,10	0,40		7,73	8,87	7,73	8,87		7,73																		
12,700	4,76	1,20	5,16	0,50	2,50	0,15	0,50		7,73	8,87	7,73	8,87																				

								1	2	3	4	5	7	8	9	10	11	12	13	14	20	21	22	23	24	25
9,525	3,18	0,40	3,81	0,50	4,00	0,08	0,32										6,16		6,41	6,16						
12,700	4,76	0,40	5,16	0,50	4,00	0,08	0,32										9,04		9,04	8,68						
12,700	4,76	0,80	5,16	0,50	4,00	0,08	0,32										9,04		9,04	8,68						
12,700	4,76	1,20	5,16	0,50	4,00	0,08	0,32										9,04		9,04	8,68						

								1	2	3	4	5	7	8	9	10	11	12	13	14	20	21	22	23	24	25
12,700	4,76	0,40	5,16	0,60	3,00	0,10	0,23								8,60	8,87	8,60		8,87				8,60			8,60
12,700	4,76	0,80	5,16	0,60	3,00	0,12	0,38								8,60	8,87	8,60		8,87				8,60			8,60
12,700	4,76	1,20	5,16	0,60	3,00	0,15	0,55								8,60	8,87	8,60		8,87				8,60			8,60

								1	2	3	4	5	7	8	9	10	11	12	13	14	20	21	22	23	24	25
12,700	4,76	0,40	5,16	0,40	2,50	0,07	0,30								7,73	8,87	7,73	8,87								
12,700	4,76	0,80	5,16	0,40	2,50	0,10	0,40	8,87	7,73	8,87	7,73	8,87														
12,700	4,76	1,20	5,16	0,40	2,50	0,15	0,40		7,73	8,87	7,73	8,87														

Die neuen Qualitäten SW33... sind erst vollständig verfügbar wenn die Auslaufmodelle SW22... nicht mehr lagerhaltig sind.  
*The new Grades SW33... are only fully available when the discontinued models SW22... are no longer in stock.*

CNMG

▲ empfohlene Qualität (auf Lager) **recommended grade (on stock)**  
 ● alternative Qualität (auf Lager) **alternative grade (on stock)**  
 ■ Auslaufmodell (auf Lager bis ausverkauft) **discontinued model (in stock until sold out)**

Bestellcode Ordering Code	Qualität   Grades																								
	P							M								K	N	S							
	SW33105	SW22115	SW33115	SW22125	SW33125	SW22740	SW33740	SW12910	SW44115	SW12920	SW22120	SW44125	SW11425	SW22135	SW44740	SW11440	SW22705	SW22320	SW00910	SW12910	SW22410	SW11415	SW11515	SW12920	SW11420

CNMG-MS



Mittlere Bearbeitung  
Medium

	1	2	3	4	5	6	7	8	9	10	11	12	13	14	15	16	17	18	19	20	21	22	23	24	25
CNMG 120404-MS										▲									▲					▲	
CNMG 120408-MS										▲									▲					▲	
CNMG 120412-MS										▲									▲					▲	
CNMG 120416-MS										▲														▲	

CNMG-MR

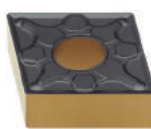

Mittlere Bearbeitung  
Medium

	1	2	3	4	5	6	7	8	9	10	11	12	13	14	15	16	17	18	19	20	21	22	23	24	25
CNMG 090304-MR	■	●	■	▲																					
CNMG 090308-MR	■	●	■	▲	■																				
CNMG 120404-MR	■	●	■	▲	■	●																			
CNMG 120408-MR	■	●	■	▲	■	●																			
CNMG 120412-MR	■	●	■	▲	■	●																			
CNMG 120416-MR	■	●	■	▲	■	●																			
CNMG 160608-MR	■	●	■	▲	■	●																			
CNMG 160612-MR	■	●	■	▲	■	●																			
CNMG 160616-MR	■	●	■	▲	■	●																			
CNMG 190612-MR	■	●	■	▲	■	●																			
CNMG 190616-MR	■	●	■	▲	■	●																			



CNMG-PM



Mittlere Bearbeitung  
Medium

	1	2	3	4	5	6	7	8	9	10	11	12	13	14	15	16	17	18	19	20	21	22	23	24	25
CNMG 120404-PM	●		●		▲																				
CNMG 120408-PM	●		●		▲																				
CNMG 120412-PM	●		●		▲																				
CNMG 120416-PM			●		▲																				



Ersetzt alte Qualität in neue Qualität. SW22115 wird durch SW33115 ersetzt. SW22125 wird durch SW33125 ersetzt. SW22740 wird durch SW33740 ersetzt.  
 Replaces old grade into new grade. SW22115 is replaced by SW33115. SW22125 is replaced by SW33125. SW22740 is replaced by SW33740.

Wettbewerbs-Qualitätsvergleich siehe Seite 150-152. Competitor grade comparison see pages 150-152. →

Wettbewerbs-Spanbrechervergleich siehe Seite 154-157. Competitor chipbreaker comparison see pages 154-157. →

CNMG

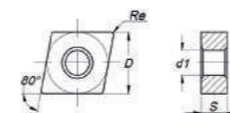

Maße Dimensions (mm)		Schnittdaten Cutting Details				Preis in €   Price in €																				
D	S	Re	d1	ap min	ap max	fn min	fn max	SW33105	SW22115	SW33115	SW22125	SW33125	SW22740	SW33740	SW12910	SW44115	SW12920	SW22120	SW22320	SW00910	SW12910	SW22410	SW11415	SW11515	SW12920	SW11420
12,700	4,76	0,40	5,16	0,20	3,60	0,10	0,20											7,73		8,00					7,73	
12,700	4,76	0,80	5,16	0,30	3,60	0,10	0,40											7,73		8,00					7,73	
12,700	4,76	1,20	5,16	0,40	3,60	0,15	0,60											7,73		8,00					7,73	
12,700	4,76	1,60	5,16	0,40	3,60	0,15	0,80											7,73							7,73	

								1	2	3	4	5	6	7	8	9	10	11	18	19	20	21	22	23	24	25
9,525	3,18	0,40	3,81	0,40	4,00	0,10	0,30		6,65	7,68	6,65	7,68														
9,525	3,18	0,80	3,81	0,50	4,00	0,15	0,50		6,65	7,68	6,65	7,68	6,65													
12,700	4,76	0,40	5,16	0,40	5,50	0,10	0,30		7,73	8,87	7,73	8,87	7,73	8,87												
12,700	4,76	0,80	5,16	0,50	5,50	0,15	0,50		7,73	8,87	7,73	8,87	7,73	8,87												
12,700	4,76	1,20	5,16	0,80	5,50	0,18	0,60		7,73	8,87	7,73	8,87	7,73	8,87												
12,700	4,76	1,60	5,16	1,00	5,50	0,23	0,65		7,73	8,87	7,73	8,87	7,73	8,87												
15,875	6,35	0,80	6,35	0,50	7,20	0,15	0,50		16,23	18,66	16,23	18,66	16,23	18,66												
15,875	6,35	1,20	6,35	0,80	7,20	0,18	0,60		16,23	18,66	16,23	18,66	16,23	18,66												
15,875	6,35	1,60	6,35	1,00	7,20	0,23	0,65		16,23	18,66	16,23	18,66	16,23	18,66												
19,050	6,35	1,20	7,94	0,80	8,60	0,18	0,60		20,55	23,80	20,55	23,80	20,55	23,80												
19,050	6,35	1,60	7,94	1,00	8,60	0,23	0,65		20,55	23,80	20,55	23,80	20,55	23,80												

								1	2	3	4	5	6	7	8	9	10	11	18	19	20	21	22	23	24	25
12,700	4,76	0,40	5,16	0,40	5,50	0,10	0,30		8,87		8,87		8,87													
12,700	4,76	0,80	5,16	0,50	5,50	0,15	0,50		8,87		8,87		8,87													
12,700	4,76	1,20	5,16	0,80	5,50	0,18	0,60		8,87		8,87		8,87													
12,700	4,76	1,60	5,16	1,00	5,50	0,23	0,65				8,87		8,87													

Die neuen Qualitäten SW33... sind erst vollständig verfügbar wenn die Auslaufmodelle SW22... nicht mehr lagerhaltig sind.  
 The new Grades SW33... are only fully available when the discontinued models SW22... are no longer in stock.







CNMG/CNMM

▲ empfohlene Qualität (auf Lager) **●** alternative Qualität (auf Lager) ■ Auslaufmodell (auf Lager bis ausverkauft)  
*recommended grade (on stock) alternative grade (on stock) discontinued model (in stock until sold out)*

CNMG-HR



Schruppen  
Roughing

Bestellcode Ordering Code	Qualität   Grades																												
	P							M							K	N	S												
	SW33105	SW22115	SW33115	SW22125	SW33125	SW22740	SW33740	SW12910	SW44115	SW12920	SW22120	SW44125	SW11425	SW22135	SW44740	SW11440	SW22705	SW22320	SW00910	SW12910	SW22410	SW11415	SW11515	SW12920	SW11420				
1	2	3	4	5	6	7	8	9	10	11	12	13	14	15	16	17	18	19	20	21	22	23	24	25					
CNMG 120408-HR	●	■	●	●	▲	■	●										▲												
CNMG 120412-HR	●	■	●	■	▲	■	●										▲												
CNMG 120416-HR		■	●	■	▲	■	●										▲												
CNMG 160608-HR		■	●	■	▲	■	●										▲												
CNMG 160612-HR		■	●	■	▲	■	●										▲												
CNMG 160616-HR		■	●	■	▲	■	●										▲												
CNMG 190612-HR		■	●	■	▲	■	●										▲												
CNMG 190616-HR		■	●	■	▲	■	●										▲												
CNMG 250924-HR				■	▲	■	●																						

NEW

CNMM-RP



Schruppen  
Roughing

	1	2	3	4	5	6	7	8	9	10	11	12	13	14	15	16	17	18	19	20	21	22	23	24	25
CNMM 160608-RP			●		▲																				
CNMM 160612-RP			●		▲																				
CNMM 160616-RP			●		▲																				
CNMM 190608-RP		■	●	■	▲																				
CNMM 190612-RP		■	●	■	▲																				
CNMM 190616-RP		■	●	■	▲																				

CNMM-HY



Schwerzerspannung  
bis Schrappen  
Heavy to Roughing

	1	2	3	4	5	6	7	8	9	10	11	12	13	14	15	16	17	18	19	20	21	22	23	24	25
CNMM 190612-HY		■	●	■	▲	■	●																		
CNMM 190616-HY		■	●	■	▲	■	●																		
CNMM 190624-HY		■	●	■	▲	■	●																		
CNMM 250924-HY		■	●	■	▲	■	●																		

CNMM-HZ



Schwerzerspannung  
bis Schrappen  
Heavy to Roughing

	1	2	3	4	5	6	7	8	9	10	11	12	13	14	15	16	17	18	19	20	21	22	23	24	25
CNMM 190612-HZ		■	●	■	▲	■	●											▲							
CNMM 190616-HZ		■	●	■	▲	■	●											▲							
CNMM 190624-HZ		■	●	■	▲	■	●											▲							
CNMM 250924-HZ		■	●	■	▲	■	●											▲							

Ersetzt alte Qualität in neue Qualität. SW22115 wird durch SW33115 ersetzt. SW22125 wird durch SW33125 ersetzt. SW22740 wird durch SW33740 ersetzt.  
*Replaces old grade into new grade. SW22115 is replaced by SW33115. SW22125 is replaced by SW33125. SW22740 is replaced by SW33740.*

Wettbewerbs-Qualitätsvergleich siehe Seite 150-152. *Competitor grade comparison see pages 150-152.* →

Wettbewerbs-Spanbrechervergleich siehe Seite 154-157. *Competitor chipbreaker comparison see pages 154-157.* →

CNMG/CNMM

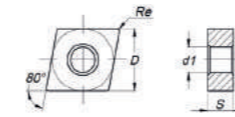

Maße Dimensions (mm)				Schnittdaten Cutting Details				Preis in €   Price in €																								
D	S	Re	d1	ap_min	ap_max	fn_min	fn_max	SW33105	SW22115	SW33115	SW22125	SW33125	SW22740	SW33740	SW22135	SW44740	SW11440	SW22705	SW22320	SW00910	SW12910	SW22410	SW11415	SW11515	SW12920	SW11420						
								1	2	3	4	5	6	7	14	15	16	17	18	19	20	21	22	23	24	25						
12,700	4,76	0,80	5,16	1,00	7,00	0,20	0,55	8,87	7,73	8,87	7,73	8,87	7,73	8,87				7,73	7,73													
12,700	4,76	1,20	5,16	1,00	7,00	0,25	0,60	8,87	7,73	8,87	7,73	8,87	7,73	8,87				7,73	7,73													
12,700	4,76	1,60	5,16	1,50	7,00	0,32	0,75		7,73	8,87	7,73	8,87	7,73	8,87				7,73	7,73													
15,875	6,35	0,80	6,35	1,00	8,00	0,20	0,55	16,23	18,66	16,23	18,66	16,23	18,66	16,23				16,23	16,23													
15,875	6,35	1,20	6,35	1,00	8,00	0,25	0,60	16,23	18,66	16,23	18,66	16,23	18,66	16,23				16,23	16,23													
15,875	6,35	1,60	6,35	1,50	8,00	0,32	0,75	16,23	18,66	16,23	18,66	16,23	18,66	16,23				16,23	16,23													
19,050	6,35	1,20	7,94	2,00	10,00	0,25	0,70	20,55	23,80	20,55	23,80	20,55	23,80	20,55				20,55	20,55													
19,050	6,35	1,60	7,94	2,00	10,00	0,32	0,80	20,55	23,80	20,55	23,80	20,55	23,80	20,55				20,55	20,55													
25,400	9,52	2,40	9,12	2,00	15,00	0,40	1,00				42,73	49,22	42,73	49,22																		

	1	2	3	4	5	6	7	14	15	16	17	18	19	20	21	22	23	24	25	
15,875	6,35	0,80	6,35	1,00	8,00	0,20	0,55		18,93		18,93									
15,875	6,35	1,20	6,35	1,00	8,00	0,25	0,60		18,93		18,93									
15,875	6,35	1,60	6,35	1,50	8,00	0,32	0,75		18,93		18,93									
19,050	6,35	1,20	6,35	2,00	10,00	0,25	0,70	23,80	23,80	23,80	23,80									
19,050	6,35	1,60	6,35	2,00	10,00	0,32	0,80	23,80	23,80	20,55	23,80									
19,050	6,35	2,40	6,35	2,00	12,00	0,35	1,20	23,80	23,80	20,55	23,80									

	1	2	3	4	5	6	7	14	15	16	17	18	19	20	21	22	23	24	25	
19,050	6,35	1,20	7,94	2,00	12,00	0,35	0,80	20,55	23,80	20,55	23,80	20,55								
19,050	6,35	1,60	7,94	2,00	12,00	0,35	1,00	20,55	23,80	20,55	23,80	20,55								
19,050	6,35	2,40	7,94	2,00	12,00	0,35	1,20	20,55	23,80	20,55	23,80	20,55								
25,400	9,52	2,40	9,12	2,50	15,00	0,40	1,40	42,73	49,22	42,73	49,22	42,73								

	1	2	3	4	5	6	7	14	15	16	17	18	19	20	21	22	23	24	25	
19,050	6,35	1,20	7,94	2,40	12,00	0,50	0,80	20,55	23,80	20,55	23,80	20,55	23,80							
19,050	6,35	1,60	7,94	2,40	12,00	0,50	1,10	20,55	23,80	20,55	23,80	20,55	23,80							
19,050	6,35	2,40	7,94	3,20	12,00	0,60	1,60	20,55	23,80	20,55	23,80	20,55	23,80							
25,400	9,52	2,40	9,12	3,20	17,00	0,60	1,60	42,73	49,22	42,73	49,22	42,73	49,22							

Die neuen Qualitäten SW33... sind erst vollständig verfügbar wenn die Auslaufmodelle SW22... nicht mehr lagerhaltig sind.  
*The new Grades SW33... are only fully available when the discontinued models SW22... are no longer in stock.*

DNMG

▲ empfohlene Qualität (auf Lager) **●** alternative Qualität (auf Lager) ■ Auslaufmodell (auf Lager bis ausverkauft)  
*recommended grade (on stock) alternative grade (on stock) discontinued model (in stock until sold out)*

Bestellcode Ordering Code	Qualität   Grades																								
	P							M								K	N	S							
	SW33105	SW22115	SW33115	SW22125	SW33125	SW22740	SW33740	SW12910	SW44115	SW12920	SW22120	SW44125	SW11425	SW22135	SW44740	SW11440	SW22705	SW22320	SW00910	SW12910	SW22410	SW11415	SW11515	SW12920	SW11420
1	2	3	4	5	6	7	8	9	10	11	12	13	14	15	16	17	18	19	20	21	22	23	24	25	
DNGG 150404-FSM																								▲	
DNGG 150408-FSM																								▲	
DNGG 150412-FSM																								▲	
DNGG 150604-FSM																								▲	
DNGG 150608-FSM																								▲	
DNGG 150612-FSM																								▲	

DNGG-FSM



Schlichten  
Finishing

Bestellcode Ordering Code	Qualität   Grades																								
	1	2	3	4	5	6	7	8	9	10	11	12	13	14	15	16	17	18	19	20	21	22	23	24	25
DNMA 110404																	▲	●							
DNMA 150404																	▲	●							
DNMA 150408																	▲	●							
DNMA 150412																	▲	●							
DNMA 150416																	▲	●							
DNMA 150604																	▲	●							
DNMA 150608																	▲	●							
DNMA 150612																	▲	●							
DNMA 150616																	▲	●							

DNMA

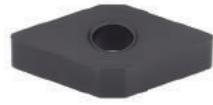

Schruppen  
Roughing

Bestellcode Ordering Code	Qualität   Grades																								
	1	2	3	4	5	6	7	8	9	10	11	12	13	14	15	16	17	18	19	20	21	22	23	24	25
DNMG 110404-MF		▲	▲	▲	●																				
DNMG 110408-MF	●	▲	▲	▲	●																				
DNMG 150404-MF		▲	▲	▲	●	■		▲																	
DNMG 150408-MF		▲	▲	▲	●	■		▲																	
DNMG 150412-MF		▲	▲	▲	●																				
DNMG 150604-MF		▲	▲	▲	●			▲																	
DNMG 150608-MF		▲	▲	▲	●			▲																	
DNMG 150612-MF		▲	▲	▲	●																				

DNMG-MF



Schlichten  
Finishing

DNMG

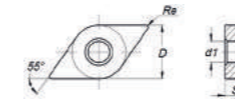

Maße Dimensions (mm)		Schnittdaten Cutting Details						Preis in €   Price in €																								
D	S	Re	d1	ap min	ap max	fn min	fn max	SW33105	SW22115	SW33115	SW22125	SW33125	SW22740	SW33740	SW12910	SW44740	SW11440	SW22705	SW22320	SW00910	SW12910	SW22410	SW11415	SW11515	SW12920	SW11420						
								1	2	3	4	5	6	7	8	15	16	17	18	19	20	21	22	23	24	25						
12,700	4,76	0,40	5,16	0,50	4,00	0,06	0,26																			14,99						
12,700	4,76	0,80	5,16	0,50	4,00	0,06	0,26																			14,99						
12,700	4,76	1,20	5,16	0,50	4,00	0,06	0,26																			14,99						
12,700	6,35	0,40	5,16	0,50	4,00	0,06	0,26																			16,15						
12,700	6,35	0,80	5,16	0,50	4,00	0,06	0,26																			16,15						
12,700	6,35	1,20	5,16	0,50	4,00	0,06	0,26																			16,15						

Maße Dimensions (mm)		Schnittdaten Cutting Details						Preis in €   Price in €																								
D	S	Re	d1	ap min	ap max	fn min	fn max	SW33105	SW22115	SW33115	SW22125	SW33125	SW22740	SW33740	SW12910	SW44740	SW11440	SW22705	SW22320	SW00910	SW12910	SW22410	SW11415	SW11515	SW12920	SW11420						
								1	2	3	4	5	6	7	8	15	16	17	18	19	20	21	22	23	24	25						
9,525	4,76	0,40	3,81	0,20	3,50	0,10	0,30											7,73	7,73													
12,700	4,76	0,40	5,16	0,20	4,00	0,10	0,30											10,49	10,49													
12,700	4,76	0,80	5,16	0,20	6,00	0,15	0,60											10,49	10,49													
12,700	4,76	1,20	5,16	0,30	6,00	0,20	0,80											10,49	10,49													
12,700	4,76	1,60	5,16	0,30	6,00	0,20	1,00											10,49	10,49													
12,700	6,35	0,40	5,16	0,20	4,00	0,10	0,30											11,09	11,09													
12,700	6,35	0,80	5,16	0,20	6,00	0,15	0,60											11,09	11,09													
12,700	6,35	1,20	5,16	0,30	6,00	0,20	0,80											11,09	11,09													
12,700	6,35	1,60	5,16	0,30	6,00	0,20	1,00											11,09	11,09													

Maße Dimensions (mm)		Schnittdaten Cutting Details						Preis in €   Price in €																								
D	S	Re	d1	ap min	ap max	fn min	fn max	SW33105	SW22115	SW33115	SW22125	SW33125	SW22740	SW33740	SW12910	SW44740	SW11440	SW22705	SW22320	SW00910	SW12910	SW22410	SW11415	SW11515	SW12920	SW11420						
								1	2	3	4	5	6	7	8	15	16	17	18	19	20	21	22	23	24	25						
9,525	4,76	0,40	3,81	0,10	1,50	0,05	0,25		7,73	8,92	7,73	8,92																				
9,525	4,76	0,80	3,81	0,10	1,50	0,10	0,40	8,92	7,73	8,92	7,73	8,92																				
12,700	4,76	0,40	5,16	0,10	1,50	0,05	0,25	10,49	12,17	10,49	12,17	10,49	10,49																			
12,700	4,76	0,80	5,16	0,10	1,50	0,10	0,40	10,49	12,17	10,49	12,17	10,49	10,49																			
12,700	4,76	1,20	5,16	0,20	2,50	0,15	0,50	10,49	12,17	10,49	12,17																					
12,700	6,35	0,40	5,16	0,10	1,50	0,05	0,25	11,09	12,98	11,09	12,98							11,09														
12,700	6,35	0,80	5,16	0,10	1,50	0,10	0,40	11,09	12,98	11,09	12,98							11,09														
12,700	6,35	1,20	5,16	0,20	2,50	0,15	0,50	11,09	12,98	11,09	12,98																					



Ersetzt alte Qualität in neue Qualität. SW22115 wird durch SW33115 ersetzt. SW22125 wird durch SW33125 ersetzt. SW22740 wird durch SW33740 ersetzt.  
*Replaces old grade into new grade. SW22115 is replaced by SW33115. SW22125 is replaced by SW33125. SW22740 is replaced by SW33740.*

Wettbewerbs-Qualitätsvergleich siehe Seite 150-152. *Competitor grade comparison see pages 150-152.* →

Wettbewerbs-Spanbrechervergleich siehe Seite 154-157. *Competitor chipbreaker comparison see pages 154-157.* →

Die neuen Qualitäten SW33... sind erst vollständig verfügbar wenn die Auslaufmodelle SW22... nicht mehr lagerhaltig sind.  
*The new Grades SW33... are only fully available when the discontinued models SW22... are no longer in stock.*

DNMG

▲ empfohlene Qualität (auf Lager) **recommended grade (on stock)**  
 ● alternative Qualität (auf Lager) **alternative grade (on stock)**  
 ■ Auslaufmodell (auf Lager bis ausverkauft) **discontinued model (in stock until sold out)**

Bestellcode Ordering Code	Qualität   Grades																								
	P							M							K	N	S								
	SW33105	SW22115	SW33115	SW22125	SW33125	SW22740	SW33740	SW12910	SW44115	SW12920	SW22120	SW44125	SW11425	SW22135	SW44740	SW11440	SW22705	SW22320	SW00910	SW12910	SW22410	SW11415	SW11515	SW12920	SW11420
DNMG 110404-SFSM																									
DNMG 110408-SFSM																									
DNMG 150604-SFSM																									
DNMG 150608-SFSM																									

DNMG-SFSM



Schlichten  
Finishing

	1	2	3	4	5	6	7	8	9	10	11	12	13	14	15	16	17	18	19	20	21	22	23	24	25
DNMG 110404-SF								●	▲	●		●								●				▲	
DNMG 110408-SF								●	▲	●		●								●				▲	
DNMG 150404-SF								●	▲	●		●								●				▲	
DNMG 150408-SF								●	▲	●		●								●				▲	
DNMG 150412-SF								●	▲	●		●								●				▲	
DNMG 150604-SF								●	▲	●		●								●				▲	
DNMG 150608-SF								●	▲	●		●								●				▲	
DNMG 150612-SF								●	▲	●		●								●				▲	

DNMG-SF



Mittlere Bearbeitung  
bis Schlichten  
Medium to Finishing

	1	2	3	4	5	6	7	8	9	10	11	12	13	14	15	16	17	18	19	20	21	22	23	24	25
DNMG 150404-LC		■	▲	■	●																				
DNMG 150408-LC		■	▲	■	●																				
DNMG 150412-LC		■	▲	■	●																				
DNMG 150604-LC	●	■	▲	■	●																				
DNMG 150608-LC	●	■	▲	■	●																				
DNMG 150612-LC	●	■	▲	■	●																				

DNMG-LC

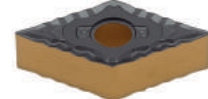

Mittlere Bearbeitung  
bis Schlichten  
Medium to Finishing

DNMG

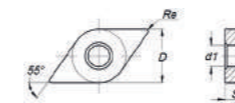

Maße Dimensions (mm)		Schnittdaten Cutting Details						Preis in €   Price in €																							
D	S	Re	d1	ap <sub>min</sub>	ap <sub>max</sub>	fn <sub>min</sub>	fn <sub>max</sub>	SW33105	SW22115	SW33115	SW22125	SW33125	SW12910	SW44115	SW12920	SW22120	SW44125	SW11425	SW22135	SW22705	SW22320	SW12910	SW22410	SW11415	SW11515	SW12920					
								1	2	3	4	5	8	9	10	11	12	13	14	17	18	20	21	22	23	24					
9,525	4,76	0,40	3,81	0,50	4,00	0,08	0,32									9,04		9,04	8,69												
9,525	4,76	0,80	3,81	0,50	4,00	0,08	0,32											9,04	8,69												
12,700	6,35	0,40	5,16	0,50	4,00	0,08	0,32									12,20		12,70	12,20												
12,700	6,35	0,80	5,16	0,50	4,00	0,08	0,32									12,20		12,70	12,20												

	1	2	3	4	5	8	9	10	11	12	13	14	17	18	20	21	22	23	24						
9,525	4,76	0,40	3,81	0,60	3,00	0,10	0,23								8,60	8,92	8,60		8,92				8,60		8,60
9,525	4,76	0,80	3,81	0,60	3,00	0,12	0,38								8,60	8,92	8,60		8,92				8,60		8,60
12,700	4,76	0,40	5,16	0,60	3,00	0,10	0,23								11,36	12,17	11,36		12,17				11,36		11,36
12,700	4,76	0,80	5,16	0,60	3,00	0,12	0,38								11,36	12,17	11,36		12,17				11,36		11,36
12,700	4,76	1,20	5,16	0,60	3,00	0,15	0,55								11,36	12,17	11,36		12,17				11,36		11,36
12,700	6,35	0,40	5,16	0,60	3,00	0,10	0,23								12,71	12,98	12,71		12,98				12,71		12,71
12,700	6,35	0,80	5,16	0,60	3,00	0,12	0,38								12,71	12,98	12,71		12,98				12,71		12,71
12,700	6,35	1,20	5,16	0,60	3,00	0,15	0,55								12,71	12,98	12,71		12,98				12,71		12,71

	1	2	3	4	5	8	9	10	11	12	13	14	17	18	20	21	22	23	24						
12,700	4,76	0,40	5,16	0,40	2,50	0,07	0,30								10,49	12,17	10,49	12,17							
12,700	4,76	0,80	5,16	0,40	2,50	0,10	0,40								10,49	12,17	10,49	12,17							
12,700	4,76	1,20	5,16	0,80	3,00	0,15	0,50								10,49	12,17	10,49	12,17							
12,700	6,35	0,40	5,16	0,40	3,00	0,07	0,30	12,98	11,09	12,98	11,09	12,98													
12,700	6,35	0,80	5,16	0,40	3,00	0,10	0,40	12,98	11,09	12,98	11,09	12,98													
12,700	6,35	1,20	5,16	0,80	3,50	0,15	0,50	12,98	11,09	12,98	11,09	12,98													



Ersetzt alte Qualität in neue Qualität. SW22115 wird durch SW33115 ersetzt. SW22125 wird durch SW33125 ersetzt. SW22740 wird durch SW33740 ersetzt.  
 Replaces old grade into new grade. SW22115 is replaced by SW33115. SW22125 is replaced by SW33125. SW22740 is replaced by SW33740.

Wettbewerbs-Qualitätsvergleich siehe Seite 150-152. Competitor grade comparison see pages 150-152. →  
 Wettbewerbs-Spanbrechervergleich siehe Seite 154-157. Competitor chipbreaker comparison see pages 154-157. →

Die neuen Qualitäten SW33... sind erst vollständig verfügbar wenn die Auslaufmodelle SW22... nicht mehr lagerhaltig sind.  
 The new Grades SW33... are only fully available when the discontinued models SW22... are no longer in stock.



DNMG

▲ empfohlene Qualität (auf Lager) **●** alternative Qualität (auf Lager) ■ Auslaufmodell (auf Lager bis ausverkauft)  
*recommended grade (on stock) alternative grade (on stock) discontinued model (in stock until sold out)*

Bestellcode Ordering Code	Qualität   Grades																								
	P							M								K	N	S							
	SW33105	SW22115	SW33115	SW22125	SW33125	SW22740	SW33740	SW12910	SW44115	SW12920	SW22120	SW44125	SW11425	SW22135	SW44740	SW11440	SW22705	SW22320	SW00910	SW12910	SW22410	SW11415	SW11515	SW12920	SW11420

DNMG-MSS



Mittlere Bearbeitung bis Schlichten  
*Medium to Finishing*

	1	2	3	4	5	6	7	8	9	10	11	12	13	14	15	16	17	18	19	20	21	22	23	24	25
DNMG 150404-MSS																									▲
DNMG 150408-MSS																									▲
DNMG 150412-MSS																									▲
DNMG 150604-MSS																									▲
DNMG 150608-MSS																									▲
DNMG 150612-MSS																									▲

DNMG-MTS



Mittlere Bearbeitung  
*Medium*

	1	2	3	4	5	6	7	8	9	10	11	12	13	14	15	16	17	18	19	20	21	22	23	24	25	
DNMG 150608-MTS																						▲				▲

DNMG-MMX



Mittlere Bearbeitung  
*Medium*

	1	2	3	4	5	6	7	8	9	10	11	12	13	14	15	16	17	18	19	20	21	22	23	24	25
DNMG 110404-MMX													▲												
DNMG 110408-MMX													▲												
DNMG 150404-MMX											▲		▲												
DNMG 150408-MMX											▲		▲												
DNMG 150604-MMX											▲		▲												
DNMG 150608-MMX											▲		▲				▲								
DNMG 150612-MMX											▲		▲												

DNMG-SMR

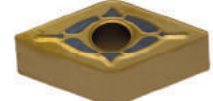

Mittlere Bearbeitung  
*Medium*

	1	2	3	4	5	6	7	8	9	10	11	12	13	14	15	16	17	18	19	20	21	22	23	24	25
DNMG 150608-SMR														▲		▲									
DNMG 150612-SMR														▲		▲									



Ersetzt alte Qualität in neue Qualität. SW22115 wird durch SW33115 ersetzt. SW22125 wird durch SW33125 ersetzt. SW22740 wird durch SW33740 ersetzt.  
*Replaces old grade into new grade. SW22115 is replaced by SW33115. SW22125 is replaced by SW33125. SW22740 is replaced by SW33740.*

Wettbewerbs-Qualitätsvergleich siehe Seite 150-152. *Competitor grade comparison see pages 150-152.* →  
 Wettbewerbs-Spanbrechervergleich siehe Seite 154-157. *Competitor chipbreaker comparison see pages 154-157.* →

DNMG

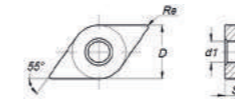

Maße Dimensions (mm)		Schnittdaten Cutting Details				Preis in €   Price in €																				
D	S	Re	d1	ap <sub>min</sub>	ap <sub>max</sub>	fn <sub>min</sub>	fn <sub>max</sub>	SW33105	SW22115	SW33115	SW22125	SW33125	SW22740	SW12920	SW22120	SW11425	SW22135	SW11440	SW22705	SW22320	SW00910	SW22410	SW11415	SW11515	SW12920	SW11420
								1	2	3	4	5	6	8	11	13	14	16	17	18	19	21	22	23	24	25
12,700	4,76	0,40	5,16	1,00	3,50	0,10	0,32																			12,20
12,700	4,76	0,80	5,16	1,00	3,50	0,10	0,32																			12,20
12,700	4,76	1,20	5,16	1,00	3,50	0,10	0,32																			12,20
12,700	6,35	0,40	5,16	1,00	3,50	0,10	0,32																			12,20
12,700	6,35	0,80	5,16	1,00	3,50	0,10	0,32																			12,20
12,700	6,35	1,20	5,16	1,00	3,50	0,10	0,32																			12,20

	1	2	3	4	5	6	8	11	13	14	16	17	18	19	21	22	23	24	25						
12,700 6,35 0,80 5,16 1,00 5,00 0,20 0,45																12,70									12,70

	1	2	3	4	5	6	8	11	13	14	16	17	18	19	21	22	23	24	25						
9,525 4,76 0,40 3,82 1,20 3,50 0,32 0,75																9,04									
9,525 4,76 0,80 3,82 1,20 3,50 0,32 0,75																9,04									
12,700 4,76 0,40 5,16 1,00 3,80 0,17 0,45															11,40	11,40									
12,700 4,76 0,80 5,16 1,00 3,80 0,17 0,45															11,40	11,40									
12,700 6,35 0,40 5,16 1,00 3,80 0,17 0,45															12,70	12,70									
12,700 6,35 0,80 5,16 1,00 3,80 0,17 0,45															12,70	12,70		12,70							
12,700 6,35 1,20 5,16 1,00 3,80 0,17 0,45															12,70	12,70		12,70							

	1	2	3	4	5	6	8	11	13	14	16	17	18	19	21	22	23	24	25						
12,700 6,35 0,80 5,16 1,20 7,50 0,32 0,80																12,20	12,70								
12,700 6,35 1,20 5,16 1,20 7,50 0,32 0,80																12,20	12,70								

Die neuen Qualitäten SW33... sind erst vollständig verfügbar wenn die Auslaufmodelle SW22... nicht mehr lagerhaltig sind.  
*The new Grades SW33... are only fully available when the discontinued models SW22... are no longer in stock.*





DNMG/DNMM

▲ empfohlene Qualität (auf Lager) recommended grade (on stock) ● alternative Qualität (auf Lager) alternative grade (on stock) ■ Auslaufmodell (auf Lager bis ausverkauft) discontinued model (in stock until sold out)

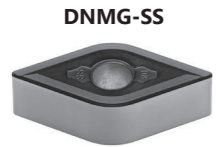

Schruppen bis Mittlere Bearbeitung  
Roughing to Medium

Bestellcode Ordering Code	Qualität   Grades																								
	P							M								K	N	S							
	SW33105	SW22115	SW33115	SW22125	SW33125	SW22740	SW33740	SW12910	SW44115	SW12920	SW22120	SW44125	SW11425	SW22135	SW44740	SW11440	SW22705	SW22320	SW00910	SW12910	SW22410	SW11415	SW11515	SW12920	SW11420
DNMG 110408-SS							●		●		▲								●					▲	
DNMG 150404-SS							●	●	●		▲								●					▲	
DNMG 150408-SS							●	●	●		▲								●					▲	
DNMG 150412-SS							●	●	●		▲								●					▲	
DNMG 150604-SS							●	●	●		▲								●					▲	
DNMG 150608-SS							●	●	●		▲								●					▲	
DNMG 150612-SS							●	●	●		▲								●					▲	
DNMG 150616-SS								●			▲													▲	

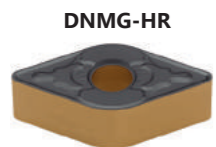

Schruppen  
Roughing

	1	2	3	4	5	6	7	8	9	10	11	12	13	14	15	16	17	18	19	20	21	22	23	24	25
DNMG 150408-HR	■	●	■	▲	●	■											●	▲							
DNMG 150412-HR	■	●	■	▲	●	■											●	▲							
DNMG 150608-HR	■	●	■	▲	●	■											●	▲							
DNMG 150612-HR	■	●	■	▲	●	■											●	▲							
DNMG 150616-HR	■	●	■	▲	●	■											●	▲							

NEW DNMM-RP



Schruppen  
Roughing

	1	2	3	4	5	6	7	8	9	10	11	12	13	14	15	16	17	18	19	20	21	22	23	24	25
DNMM 150608-RP			●		▲																				
DNMM 150612-RP			●		▲																				
DNMM 150616-RP			●		▲																				

Ersetzt alte Qualität in neue Qualität. SW22115 wird durch SW33115 ersetzt. SW22125 wird durch SW33125 ersetzt. SW22740 wird durch SW33740 ersetzt.  
Replaces old grade into new grade. SW22115 is replaced by SW33115. SW22125 is replaced by SW33125. SW22740 is replaced by SW33740.

Wettbewerbs-Qualitätsvergleich siehe Seite 150-152. Competitor grade comparison see pages 150-152. →  
Wettbewerbs-Spanbrechervergleich siehe Seite 154-157. Competitor chipbreaker comparison see pages 154-157. →

DNMG/DNMM

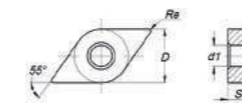

Maße Dimensions (mm)		Schnittdaten Cutting Details				Preis in €   Price in €																						
D	S	Re	d1	ap <sub>min</sub>	ap <sub>max</sub>	fn <sub>min</sub>	fn <sub>max</sub>	SW33105	SW22115	SW33115	SW22125	SW33125	SW22740	SW33740	SW12910	SW44115	SW12920	SW22120	SW44125	SW22705	SW22320	SW00910	SW12910	SW22410	SW11415	SW11515	SW12920	SW11420
								1	2	3	4	5	6	7	8	9	10	11	12	17	18	19	20	21	24	25		
9,525	4,76	0,80	3,81	0,50	4,40	0,12	0,45								8,60	8,60	8,92						8,60	8,60				
12,700	4,76	0,40	5,16	0,30	6,00	0,10	0,30								11,36	12,17	11,36	12,17					11,36	11,36				
12,700	4,76	0,80	5,16	0,50	6,40	0,12	0,45								11,36	12,17	11,36	12,17					11,36	11,36				
12,700	4,76	1,20	5,16	0,50	6,40	0,15	0,60								11,36	12,17	11,36	12,17					11,36	11,36				
12,700	6,35	0,40	5,16	0,30	6,00	0,10	0,30								12,71	12,98	12,71	12,98					12,71	12,71				
12,700	6,35	0,80	5,16	0,50	6,40	0,12	0,45								12,71	12,98	12,71	12,98					12,71	12,71				
12,700	6,35	1,20	5,16	0,50	6,40	0,15	0,60								12,71	12,98	12,71	12,98					12,71	12,71				
12,700	6,35	1,60	5,16	0,50	6,40	0,20	1,00										12,71	12,98								12,71		

	1	2	3	4	5	6	7	8	9	10	11	12	17	18	19	20	21	24	25							
12,700	4,76	0,80	5,16	0,80	6,00	0,20	0,55	10,49	12,17	10,49	12,17	10,49	12,17							10,49	10,49					
12,700	4,76	1,20	5,16	1,00	6,00	0,25	0,70	10,49	12,17	10,49	12,17	10,49	12,17							10,49	10,49					
12,700	6,35	0,80	5,16	0,80	6,00	0,20	0,55	11,09	12,98	11,09	12,98	11,09	12,98							11,09	11,09					
12,700	6,35	1,20	5,16	1,00	6,00	0,25	0,70	11,09	12,98	11,09	12,98	11,09	12,98							11,09	11,09					
12,700	6,35	1,60	5,16	1,50	6,00	0,30	0,80	11,09	12,98	11,09	12,98	11,09	12,98							11,09	11,09					

	1	2	3	4	5	6	7	8	9	10	11	12	17	18	19	20	21	24	25							
12,700	6,35	0,80	5,16	0,80	6,00	0,20	0,55			14,60	14,60															
12,700	6,35	1,20	5,16	1,00	6,00	0,25	0,70			14,60	14,60															
12,700	6,35	1,60	5,16	1,50	6,00	0,30	0,80			14,60	14,60															

Die neuen Qualitäten SW33... sind erst vollständig verfügbar wenn die Auslaufmodelle SW22... nicht mehr lagerhaltig sind.  
The new Grades SW33... are only fully available when the discontinued models SW22... are no longer in stock.

DNMX

▲ empfohlene Qualität (auf Lager) **●** alternative Qualität (auf Lager) ■ Auslaufmodell (auf Lager bis ausverkauft)  
*recommended grade (on stock) alternative grade (on stock) discontinued model (in stock until sold out)*

Bestellcode Ordering Code	Qualität   Grades																								
	P							M								K	N	S							
	SW33105	SW22115	SW33115	SW22125	SW33125	SW22740	SW33740	SW12910	SW44115	SW12920	SW22120	SW44125	SW11425	SW22135	SW44740	SW11440	SW22705	SW22320	SW00910	SW12910	SW22410	SW11415	SW11515	SW12920	SW11420



DNMX-02

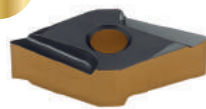

Mittlere Bearbeitung bis Schlichten  
*Medium to Finishing*

	1	2	3	4	5	6	7	8	9	10	11	12	13	14	15	16	17	18	19	20	21	22	23	24	25
DNMX 150604-L02	■	▲	■	●																					
DNMX 150604-R02	■	▲	■	●																					
DNMX 150608-L02	■	▲	■	●																					
DNMX 150608-R02	■	▲	■	●																					



DNMX-03

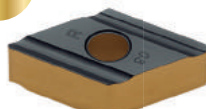

Mittlere Bearbeitung  
*Medium*

	1	2	3	4	5	6	7	8	9	10	11	12	13	14	15	16	17	18	19	20	21	22	23	24	25
DNMX 150604-L03	■	▲	■	●																					
DNMX 150604-R03	■	▲	■	●																					
DNMX 150608-L03	■	▲	■	●																					
DNMX 150608-R03	■	▲	■	●																					



DNMX-01

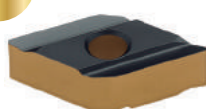

Schruppen bis Mittlere Bearbeitung  
*Roughing to Medium*

	1	2	3	4	5	6	7	8	9	10	11	12	13	14	15	16	17	18	19	20	21	22	23	24	25
DNMX 150408-L01	■	●	■	▲																					
DNMX 150408-R01	■	●	■	▲																					
DNMX 150604-L01	■	●	■	▲																					
DNMX 150604-R01	■	●	■	▲																					
DNMX 150608-L01	■	●	■	▲																					
DNMX 150608-R01	■	●	■	▲																					



Ersetzt alte Qualität in neue Qualität. SW22115 wird durch SW33115 ersetzt. SW22125 wird durch SW33125 ersetzt. SW22740 wird durch SW33740 ersetzt.  
*Replaces old grade into new grade. SW22115 is replaced by SW33115. SW22125 is replaced by SW33125. SW22740 is replaced by SW33740.*

Wettbewerbs-Qualitätsvergleich siehe Seite 150-152. *Competitor grade comparison see pages 150-152.* →

Wettbewerbs-Spanbrechervergleich siehe Seite 154-157. *Competitor chipbreaker comparison see pages 154-157.* →

DNMX

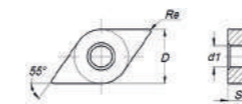

Maße Dimensions (mm)		Schnittdaten Cutting Details				Preis in €   Price in €																				
D	S	Re	d1	ap <sub>min</sub>	ap <sub>max</sub>	fn <sub>min</sub>	fn <sub>max</sub>	SW33105	SW22115	SW33115	SW22125	SW33125	SW22740	SW33740	SW22135	SW44740	SW11440	SW22705	SW22320	SW00910	SW12910	SW22410	SW11415	SW11515	SW12920	SW11420
								1	2	3	4	5	6	7	14	15	16	17	18	19	20	21	22	23	24	25
12,700	6,35	0,40	5,16	0,70	5,00	0,14	0,25	11,09	12,17	11,09	12,17															
12,700	6,35	0,40	5,16	0,70	5,00	0,14	0,25	11,09	12,17	11,09	12,17															
12,700	6,35	0,80	5,16	8,00	5,00	0,14	0,50	11,09	12,17	11,09	12,17															
12,700	6,35	0,80	5,16	8,00	5,00	0,14	0,50	11,09	12,17	11,09	12,17															

								1	2	3	4	5	6	7	14	15	16	17	18	19	20	21	22	23	24	25
12,700	6,35	0,40	5,16	0,80	5,50	0,15	0,25	11,09	12,17	11,09	12,17															
12,700	6,35	0,40	5,16	0,80	5,50	0,15	0,25	11,09	12,17	11,09	12,17															
12,700	6,35	0,80	5,16	1,00	6,00	0,16	0,50	11,09	12,17	11,09	12,17															
12,700	6,35	0,80	5,16	1,00	6,00	0,16	0,50	11,09	12,17	11,09	12,17															

								1	2	3	4	5	6	7	14	15	16	17	18	19	20	21	22	23	24	25
12,700	4,76	0,80	5,16	1,00	5,00	0,20	0,50	10,49	11,90	10,49	11,90															
12,700	4,76	0,80	5,16	1,00	5,00	0,20	0,50	10,49	11,90	10,49	11,90															
12,700	6,35	0,40	5,16	1,50	6,00	0,15	0,30	11,09	12,17	11,09	12,17															
12,700	6,35	0,40	5,16	1,50	6,00	0,15	0,30	11,09	12,17	11,09	12,17															
12,700	6,35	0,80	5,16	2,00	6,50	0,20	0,50	11,09	12,17	11,09	12,17															
12,700	6,35	0,80	5,16	2,00	6,50	0,20	0,50	11,09	12,17	11,09	12,17															

Die neuen Qualitäten SW33... sind erst vollständig verfügbar wenn die Auslaufmodelle SW22... nicht mehr lagerhaltig sind.  
*The new Grades SW33... are only fully available when the discontinued models SW22... are no longer in stock.*

KNUX

▲ empfohlene Qualität (auf Lager) **recommended grade (on stock)**  
 ● alternative Qualität (auf Lager) **alternative grade (on stock)**  
 ■ Auslaufmodell (auf Lager bis ausverkauft) **discontinued model (in stock until sold out)**

NEW

KNUX-01

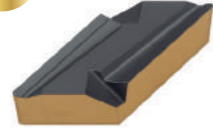

Schlichten  
Finishing

NEW

KNUX-02



Mittlere Bearbeitung  
Medium

Bestellcode Ordering Code	Qualität   Grades																								
	P							M								K	N	S							
	SW33105	SW22115	SW33115	SW22125	SW33125	SW22740	SW33740	SW12910	SW44115	SW12920	SW22120	SW44125	SW11425	SW22135	SW44740	SW11440	SW22705	SW22320	SW00910	SW12910	SW22410	SW11415	SW11515	SW12920	SW11420
KNUX 160405-L01	■	▲	■	●																					
KNUX 160405-R01	■	▲	●	●																					

Bestellcode Ordering Code	Qualität   Grades																								
	P							M								K	N	S							
	SW33105	SW22115	SW33115	SW22125	SW33125	SW22740	SW33740	SW12910	SW44115	SW12920	SW22120	SW44125	SW11425	SW22135	SW44740	SW11440	SW22705	SW22320	SW00910	SW12910	SW22410	SW11415	SW11515	SW12920	SW11420
KNUX 160410-L02	■	●	■	▲																					
KNUX 160410-R02	■	●	■	▲																					

KNUX

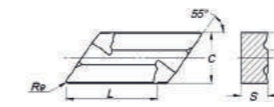

Maße Dimensions (mm)		Schnittdaten Cutting Details				Preis in €   Price in €																					
L	C	Re	S	b	ap <sub>min</sub>	ap <sub>max</sub>	fn <sub>min</sub>	fn <sub>max</sub>	SW33105	SW22115	SW33115	SW22125	SW33125	SW22740	SW33740	SW12910	SW44740	SW11440	SW22705	SW22320	SW00910	SW12910	SW22410	SW11415	SW11515	SW12920	SW11420
16,50	9,525	0,50	4,76	2,50	1,00	6,00	0,20	0,35	10,76	12,39	10,76	12,39															
16,50	9,525	0,50	4,76	2,50	1,00	6,00	0,20	0,35	10,76	12,39	10,76	12,39															

Maße Dimensions (mm)		Schnittdaten Cutting Details				Preis in €   Price in €																					
L	C	Re	S	b	ap <sub>min</sub>	ap <sub>max</sub>	fn <sub>min</sub>	fn <sub>max</sub>	SW33105	SW22115	SW33115	SW22125	SW33125	SW22740	SW33740	SW12910	SW44740	SW11440	SW22705	SW22320	SW00910	SW12910	SW22410	SW11415	SW11515	SW12920	SW11420
16,50	9,525	1,00	4,76	3,20	1,50	6,00	0,40	0,70	10,76	12,39	10,76	12,39															
16,50	9,525	1,00	4,76	3,20	1,50	6,00	0,40	0,70	10,76	12,39	10,76	12,39															



Ersetzt alte Qualität in neue Qualität. SW22115 wird durch SW33115 ersetzt. SW22125 wird durch SW33125 ersetzt. SW22740 wird durch SW33740 ersetzt.  
 Replaces old grade into new grade. SW22115 is replaced by SW33115. SW22125 is replaced by SW33125. SW22740 is replaced by SW33740.

Wettbewerbs-Qualitätsvergleich siehe Seite 150-152. [Competitor grade comparison see pages 150-152.](#)  
 Wettbewerbs-Spanbrechervergleich siehe Seite 154-157. [Competitor chipbreaker comparison see pages 154-157.](#)

Die neuen Qualitäten SW33... sind erst vollständig verfügbar wenn die Auslaufmodelle SW22... nicht mehr lagerhaltig sind.  
 The new Grades SW33... are only fully available when the discontinued models SW22... are no longer in stock.

RNMG

▲ empfohlene Qualität (auf Lager) **recommended grade (on stock)**  
 ● alternative Qualität (auf Lager) **alternative grade (on stock)**  
 ■ Auslaufmodell (auf Lager bis ausverkauft) **discontinued model (in stock until sold out)**

Bestellcode Ordering Code	Qualität   Grades																								
	P						M										K		N	S					
	SW33105	SW22115	SW33115	SW22125	SW33125	SW22740	SW33740	SW12910	SW44115	SW12920	SW22120	SW44125	SW11425	SW22135	SW44740	SW11440	SW22705	SW22320	SW00910	SW12910	SW22410	SW11415	SW11515	SW12920	SW11420

RNMG-ST

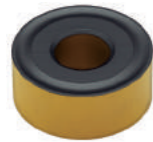

Mittlere Bearbeitung  
Medium

	1	2	3	4	5	6	7	8	9	10	11	12	13	14	15	16	17	18	19	20	21	22	23	24	25
RNMG 090300-ST				▲	▲	■												■							
RNMG 120400-ST				▲	▲	■												■							
RNMG 150600-ST				▲	▲	■																			
RNMG 190600-ST	■			▲	▲	■																			
RNMG 250900-ST	■	●	■	▲	▲	■												▲							

RNMG

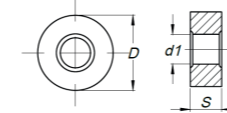

Maße Dimensions (mm)		Schnittdaten Cutting Details				Preis in €   Price in €																				
D	S	Re	d1	ap min	ap max	fn min	fn max	SW33105	SW22115	SW33115	SW22125	SW33125	SW22740	SW33740	SW12910	SW44740	SW11440	SW22705	SW22320	SW00910	SW12910	SW22410	SW11415	SW11515	SW12920	SW11420
								1	2	3	4	5	6	7	8	15	16	17	18	19	20	21	22	23	24	25
9,525	3,18	-	3,18	0,90	4,50	0,10	0,90				7,19	8,33	7,19							7,19						
12,700	4,76	-	5,16	1,20	4,80	0,12	1,20				8,87	10,22	8,87							8,87						
15,875	6,35	-	6,35	1,50	7,50	0,15	1,50				13,79	15,96	13,79													
19,050	6,35	-	7,94	1,90	7,60	0,20	1,90	16,77			16,77	19,31	16,77													
25,400	9,52	-	9,12	2,50	10,00	0,25	2,50	38,67	44,35	38,67	44,35	38,67							38,67							



Ersetzt alte Qualität in neue Qualität. SW22115 wird durch SW33115 ersetzt. SW22125 wird durch SW33125 ersetzt. SW22740 wird durch SW33740 ersetzt.  
 Replaces old grade into new grade. SW22115 is replaced by SW33115. SW22125 is replaced by SW33125. SW22740 is replaced by SW33740.

Wettbewerbs-Qualitätsvergleich siehe Seite 150-152. [Competitor grade comparison see pages 150-152.](#)  
 Wettbewerbs-Spanbrechervergleich siehe Seite 154-157. [Competitor chipbreaker comparison see pages 154-157.](#)

Die neuen Qualitäten SW33... sind erst vollständig verfügbar wenn die Auslaufmodelle SW22... nicht mehr lagerhaltig sind.  
 The new Grades SW33... are only fully available when the discontinued models SW22... are no longer in stock.



SNMA/SNMG

▲ empfohlene Qualität (auf Lager) recommended grade (on stock) ● alternative Qualität (auf Lager) alternative grade (on stock) ■ Auslaufmodell (auf Lager bis ausverkauft) discontinued model (in stock until sold out)

Bestellcode Ordering Code	Qualität   Grades																								
	P							M								K	N	S							
	SW33105	SW22115	SW33115	SW22125	SW33125	SW22740	SW33740	SW12910	SW44115	SW12920	SW22120	SW44125	SW11425	SW22135	SW44740	SW11440	SW22705	SW22320	SW00910	SW12910	SW22410	SW11415	SW11515	SW12920	SW11420
1	2	3	4	5	6	7	8	9	10	11	12	13	14	15	16	17	18	19	20	21	22	23	24	25	
SNMA 090304																	▲	●							
SNMA 090308																	▲	●							
SNMA 120404																	●	▲							
SNMA 120408																	●	▲							
SNMA 120412																	●	▲							
SNMA 120416																	●	▲							
SNMA 150412																	●	▲							
SNMA 150612																	●	▲							
SNMA 190612																	●	▲							
SNMA 190616																	●	▲							
SNMA 190624																	●	▲							
SNMA 250724																	●	▲							

SNMA



Schruppen  
Roughing

SNMG-MF



Schlichten  
Finishing

SNMG-FSM



Schlichten  
Finishing



SNMG-SF



Mittlere Bearbeitung  
bis Schlichten  
Medium to Finishing



Ersetzt alte Qualität in neue Qualität. SW22115 wird durch SW33115 ersetzt. SW22125 wird durch SW33125 ersetzt. SW22740 wird durch SW33740 ersetzt.  
Replaces old grade into new grade. SW22115 is replaced by SW33115. SW22125 is replaced by SW33125. SW22740 is replaced by SW33740.

Wettbewerbs-Qualitätsvergleich siehe Seite 150-152. Competitor grade comparison see pages 150-152. →

Wettbewerbs-Spanbrechervergleich siehe Seite 154-157. Competitor chipbreaker comparison see pages 154-157. →

SNMA/SNMG

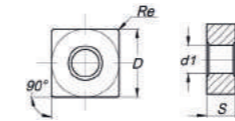

Maße Dimensions (mm)		Schnittdaten Cutting Details				Preis in €   Price in €																				
D	S	Re	d1	ap min	ap max	fn min	fn max	SW33105	SW22115	SW33115	SW22125	SW33125	SW22740	SW12910	SW44115	SW12920	SW44125	SW22705	SW22320	SW00910	SW12910	SW22410	SW11415	SW11515	SW12920	SW11420
								1	2	3	4	5	6	8	9	10	12	17	18	19	20	21	22	23	24	25
9,525	3,18	0,40	3,81	0,20	4,50	0,15	0,30											6,65	6,65							
9,525	3,18	0,80	3,81	0,40	4,50	0,20	0,60											6,65	6,65							
12,700	4,76	0,40	5,16	0,20	8,00	0,15	0,30											7,73	7,73							
12,700	4,76	0,80	5,16	0,20	8,00	0,20	0,60											7,73	7,73							
12,700	4,76	1,20	5,16	0,30	8,00	0,20	0,80											7,73	7,73							
12,700	4,76	1,60	5,16	0,30	8,00	0,20	1,00											7,73	7,73							
15,875	4,76	1,20	6,35	0,30	9,00	0,20	0,80											15,14	15,14							
15,875	6,35	1,20	6,35	0,30	10,00	0,20	0,80											15,14	15,14							
19,050	6,35	1,20	7,94	0,30	12,00	0,20	0,80											18,93	18,93							
19,050	6,35	1,60	7,94	0,30	12,00	0,20	1,00											18,93	18,93							
19,050	6,35	2,40	7,94	0,30	12,00	0,20	1,20											18,93	18,93							
25,400	7,94	2,40	9,12	0,40	12,00	0,20	1,40											35,97	35,97							

Maße Dimensions (mm)		Schnittdaten Cutting Details				Preis in €   Price in €																				
D	S	Re	d1	ap min	ap max	fn min	fn max	SW33105	SW22115	SW33115	SW22125	SW33125	SW22740	SW12910	SW44115	SW12920	SW44125	SW22705	SW22320	SW00910	SW12910	SW22410	SW11415	SW11515	SW12920	SW11420
								1	2	3	4	5	6	8	9	10	12	17	18	19	20	21	22	23	24	25
12,700	4,76	0,40	5,16	0,10	1,50	0,05	0,25		7,73	8,87	7,73	8,87	7,73	7,73												
12,700	4,76	0,80	5,16	0,10	1,50	0,10	0,40		7,73	8,87	7,73	8,87		7,73												
12,700	4,76	1,20	5,16	0,15	2,50	0,20	0,60		7,73	8,87	7,73	8,87														

Maße Dimensions (mm)		Schnittdaten Cutting Details				Preis in €   Price in €																				
D	S	Re	d1	ap min	ap max	fn min	fn max	SW33105	SW22115	SW33115	SW22125	SW33125	SW22740	SW12910	SW44115	SW12920	SW44125	SW22705	SW22320	SW00910	SW12910	SW22410	SW11415	SW11515	SW12920	SW11420
								1	2	3	4	5	6	8	9	10	12	17	18	19	20	21	22	23	24	25
12,700	4,76	0,80	5,16	0,50	4,00	0,06	0,26																	8,45		
12,700	4,76	1,20	5,16	0,50	4,00	0,06	0,26																	8,45		

Maße Dimensions (mm)		Schnittdaten Cutting Details				Preis in €   Price in €																				
D	S	Re	d1	ap min	ap max	fn min	fn max	SW33105	SW22115	SW33115	SW22125	SW33125	SW22740	SW12910	SW44115	SW12920	SW44125	SW22705	SW22320	SW00910	SW12910	SW22410	SW11415	SW11515	SW12920	SW11420
								1	2	3	4	5	6	8	9	10	12	17	18	19	20	21	22	23	24	25
12,700	4,76	0,40	5,16	1,00	4,00	0,10	0,23							8,60	8,87	8,60	8,87					8,60			8,60	
12,700	4,76	0,80	5,16	1,00	4,00	0,12	0,38							8,60	8,87	8,60	8,87					8,60			8,60	
12,700	4,76	1,20	5,16	1,00	4,00	0,15	0,55							8,60	8,87	8,60	8,87					8,60			8,60	

Die neuen Qualitäten SW33... sind erst vollständig verfügbar wenn die Auslaufmodelle SW22... nicht mehr lagerhaltig sind.  
The new Grades SW33... are only fully available when the discontinued models SW22... are no longer in stock.

SNMG

▲ empfohlene Qualität (auf Lager) **recommended grade (on stock)**  
 ● alternative Qualität (auf Lager) **alternative grade (on stock)**  
 ■ Auslaufmodell (auf Lager bis ausverkauft) **discontinued model (in stock until sold out)**

Bestellcode Ordering Code	Qualität   Grades																								
	P							M								K	N	S							
	SW33105	SW22115	SW33115	SW22125	SW33125	SW22740	SW33740	SW12910	SW44115	SW12920	SW22120	SW44125	SW11425	SW22135	SW44740	SW11440	SW22705	SW22320	SW00910	SW12910	SW22410	SW11415	SW11515	SW12920	SW11420
SNMG 120408-MMX																									
SNMG 120412-MMX																									
SNMG 150612-MMX																									
SNMG 150616-MMX																									
SNMG 190612-MMX																									
SNMG 190616-MMX																									

SNMG-MMX



Mittlere Bearbeitung  
Medium

Bestellcode Ordering Code	Qualität   Grades																								
	1	2	3	4	5	6	7	8	9	10	11	12	13	14	15	16	17	18	19	20	21	22	23	24	25
SNMG 120404-MR	■	●	■	▲	■	●																			
SNMG 120408-MR	■	●	●	▲	■	●																			
SNMG 120412-MR	■	●	■	▲	■	●																			
SNMG 120416-MR				■	▲	■	●																		
SNMG 150608-MR	■	●	■	▲	■	●																			
SNMG 150612-MR	■	●	■	▲	■	●																			
SNMG 190612-MR	■	●	■	▲	■	●																			
SNMG 190616-MR	■	●	■	▲	■	●																			

SNMG-MR



Mittlere Bearbeitung  
Medium



SNMG-PM



Mittlere Bearbeitung  
Medium

Bestellcode Ordering Code	Qualität   Grades																								
	1	2	3	4	5	6	7	8	9	10	11	12	13	14	15	16	17	18	19	20	21	22	23	24	25
SNMG 120404-PM	●		●		▲																				
SNMG 120408-PM	●		●		▲																				
SNMG 120412-PM	●		●		▲																				

SNMG-SSM



Mittlere Bearbeitung  
Medium

Bestellcode Ordering Code	Qualität   Grades																								
	1	2	3	4	5	6	7	8	9	10	11	12	13	14	15	16	17	18	19	20	21	22	23	24	25
SNMG 120408-SSM																									
SNMG 120412-SSM																									

SNMG

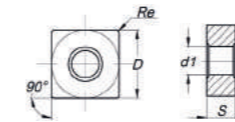

Maße Dimensions (mm)		Schnittdaten Cutting Details				Preis in €   Price in €																								
D	S	Re	d1	ap <sub>min</sub>	ap <sub>max</sub>	fn <sub>min</sub>	fn <sub>max</sub>	SW33105	SW22115	SW33115	SW22125	SW33125	SW22740	SW33740	SW12910	SW44115	SW12920	SW22120	SW44125	SW11425	SW22135	SW44740	SW11440	SW11515	SW12920	SW11420				
12,700	4,76	0,80	5,16	1,00	3,80	0,17	0,45																							
12,700	4,76	1,20	5,16	1,00	3,80	0,17	0,45																							
15,875	6,35	1,20	6,35	1,00	3,80	0,17	0,45																							
15,875	6,35	1,60	6,35	1,00	3,80	0,17	0,45																							
19,050	6,35	1,20	7,94	1,00	3,80	0,17	0,45																							
19,050	6,35	1,60	7,94	1,00	3,80	0,17	0,45																							

Maße Dimensions (mm)		Schnittdaten Cutting Details				Preis in €   Price in €																								
D	S	Re	d1	ap <sub>min</sub>	ap <sub>max</sub>	fn <sub>min</sub>	fn <sub>max</sub>	SW33105	SW22115	SW33115	SW22125	SW33125	SW22740	SW33740	SW12910	SW44115	SW12920	SW22120	SW44125	SW11425	SW22135	SW44740	SW11440	SW11515	SW12920	SW11420				
12,700	4,76	0,40	5,16	0,40	6,00	0,10	0,30																							
12,700	4,76	0,80	5,16	0,50	6,00	0,15	0,50																							
12,700	4,76	1,20	5,16	0,80	6,00	0,18	0,60																							
12,700	4,76	1,60	5,16	1,00	6,00	0,23	0,65																							
15,875	6,35	0,80	6,35	0,60	7,50	0,15	0,50																							
15,875	6,35	1,20	6,35	0,80	7,50	0,18	0,60																							
19,050	6,35	1,20	7,94	0,80	9,00	0,18	0,60																							
19,050	6,35	1,60	7,94	1,00	9,00	0,23	0,65																							

Maße Dimensions (mm)		Schnittdaten Cutting Details				Preis in €   Price in €																								
D	S	Re	d1	ap <sub>min</sub>	ap <sub>max</sub>	fn <sub>min</sub>	fn <sub>max</sub>	SW33105	SW22115	SW33115	SW22125	SW33125	SW22740	SW33740	SW12910	SW44115	SW12920	SW22120	SW44125	SW11425	SW22135	SW44740	SW11440	SW11515	SW12920	SW11420				
12,700	4,76	0,40	5,16	0,40	6,00	0,10	0,30																							
12,700	4,76	0,80	5,16	0,50	6,00	0,15	0,50																							
12,700	4,76	1,20	5,16	0,80	6,00	0,18	0,60																							

Maße Dimensions (mm)		Schnittdaten Cutting Details				Preis in €   Price in €																								
D	S	Re	d1	ap <sub>min</sub>	ap <sub>max</sub>	fn <sub>min</sub>	fn <sub>max</sub>	SW33105	SW22115	SW33115	SW22125	SW33125	SW22740	SW33740	SW12910	SW44115	SW12920	SW22120	SW44125	SW11425	SW22135	SW44740	SW11440	SW11515	SW12920	SW11420				
12,700	4,76	0,80	5,16	1,20	6,00	0,15	0,40																							
12,700	4,76	1,20	5,16	1,20	6,00	0,15	0,40																							

Ersetzt alte Qualität in neue Qualität. SW22115 wird durch SW33115 ersetzt. SW22125 wird durch SW33125 ersetzt. SW22740 wird durch SW33740 ersetzt.  
 Replaces old grade into new grade. SW22115 is replaced by SW33115. SW22125 is replaced by SW33125. SW22740 is replaced by SW33740.

Wettbewerbs-Qualitätsvergleich siehe Seite 150-152. Competitor grade comparison see pages 150-152. →  
 Wettbewerbs-Spanbrechervergleich siehe Seite 154-157. Competitor chipbreaker comparison see pages 154-157. →

Die neuen Qualitäten SW33... sind erst vollständig verfügbar wenn die Auslaufmodelle SW22... nicht mehr lagerhaltig sind.  
 The new Grades SW33... are only fully available when the discontinued models SW22... are no longer in stock.

SNMG

▲ empfohlene Qualität (auf Lager) **●** alternative Qualität (auf Lager) ■ Auslaufmodell (auf Lager bis ausverkauft)  
*recommended grade (on stock) alternative grade (on stock) discontinued model (in stock until sold out)*

Bestellcode Ordering Code	Qualität   Grades																								
	P							M								K		N	S						
	SW33105	SW22115	SW33115	SW22125	SW33125	SW22740	SW33740	SW12910	SW44115	SW12920	SW22120	SW44125	SW11425	SW22135	SW44740	SW11440	SW22705	SW22320	SW00910	SW12910	SW22410	SW11415	SW11515	SW12920	SW11420
SNMG 090308-ST																	●	▲							
SNMG 120404-ST																		▲							
SNMG 120408-ST																	●	▲							
SNMG 120412-ST																	●	▲							
SNMG 120416-ST																	●	▲							
SNMG 190612-ST																	●	▲							
SNMG 190616-ST																	●	▲							

SNMG-ST



Mittlere Bearbeitung  
Medium

SNMG-MSR



Mittlere Bearbeitung  
Medium

	1	2	3	4	5	6	7	8	9	10	11	12	13	14	15	16	17	18	19	20	21	22	23	24	25
SNMG 120408-MSR																							▲		
SNMG 120412-MSR																							▲		

SNMG-SS



Schruppen bis  
mittlere Bearbeitung  
Roughing to Medium

	1	2	3	4	5	6	7	8	9	10	11	12	13	14	15	16	17	18	19	20	21	22	23	24	25
SNMG 090304-SS								●		▲										●				▲	
SNMG 090308-SS								●		▲										●				▲	
SNMG 120404-SS								●		●		▲								●				▲	
SNMG 120408-SS								●		●		▲								●				▲	
SNMG 120412-SS								●		●		▲								●				▲	
SNMG 120416-SS									●		▲									●				▲	
SNMG 150608-SS												▲													
SNMG 150612-SS												▲													
SNMG 190616-SS												▲													



Ersetzt alte Qualität in neue Qualität. SW22115 wird durch SW33115 ersetzt. SW22125 wird durch SW33125 ersetzt. SW22740 wird durch SW33740 ersetzt.  
*Replaces old grade into new grade. SW22115 is replaced by SW33115. SW22125 is replaced by SW33125. SW22740 is replaced by SW33740.*

Wettbewerbs-Qualitätsvergleich siehe Seite 150-152. *Competitor grade comparison see pages 150-152.* →

Wettbewerbs-Spanbrechervergleich siehe Seite 154-157. *Competitor chipbreaker comparison see pages 154-157.* →

SNMG

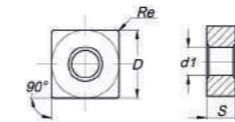

Maße Dimensions (mm)		Schnittdaten Cutting Details				Preis in €   Price in €																				
D	S	Re	d1	ap min	ap max	fn min	fn max	SW33105	SW12910	SW44115	SW12920	SW22120	SW44125	SW11425	SW22135	SW44740	SW11440	SW22705	SW22320	SW00910	SW12910	SW22410	SW11415	SW11515	SW12920	SW11420
9,525	3,18	0,80	3,81	0,20	4,50	0,15	0,50												6,65	6,65						
12,700	4,76	0,40	5,16	0,20	6,00	0,15	0,30												7,73	7,73						
12,700	4,76	0,80	5,16	0,20	6,00	0,15	0,50												7,73	7,73						
12,700	4,76	1,20	5,16	0,30	6,00	0,15	0,60												7,73	7,73						
12,700	4,76	1,60	5,16	0,30	6,00	0,20	0,70												7,73	7,73						
19,050	6,35	1,20	7,94	0,30	9,00	0,15	0,60												20,55	20,55						
19,050	6,35	1,60	7,94	0,30	9,00	0,20	0,70												20,55	20,55						

	1	8	9	10	11	12	13	14	15	16	17	18	19	20	21	22	23	24	25						
12,700	4,76	0,80	5,16	1,20	6,00	0,15	0,40																		
12,700	4,76	1,20	5,16	1,20	6,00	0,15	0,40																		

	1	8	9	10	11	12	13	14	15	16	17	18	19	20	21	22	23	24	25						
9,525	3,18	0,40	3,81	0,50	4,50	0,10	0,30	7,19	7,19										7,19					7,19	
9,525	3,18	0,80	3,81	0,50	4,50	0,12	0,45	7,19	7,19										7,19					7,19	
12,700	4,76	0,40	5,16	0,50	6,40	0,12	0,30	8,60	8,87	8,87									8,60					8,60	
12,700	4,76	0,80	5,16	0,50	6,40	0,12	0,45	8,60	8,87	8,87									8,60					8,60	
12,700	4,76	1,20	5,16	0,50	6,40	0,15	0,60	8,60	8,87	8,87									8,60					8,60	
12,700	4,76	1,60	5,16	0,50	6,40	0,15	0,80			8,87	8,87														
15,875	6,35	0,80	6,35	0,50	8,00	0,12	0,45												18,66						
15,875	6,35	1,20	6,35	0,50	8,00	0,15	0,60												18,66						
19,050	6,35	1,60	7,94	0,50	8,00	0,15	0,80												23,64						

Die neuen Qualitäten SW33... sind erst vollständig verfügbar wenn die Auslaufmodelle SW22... nicht mehr lagerhaltig sind.  
*The new Grades SW33... are only fully available when the discontinued models SW22... are no longer in stock.*

SNMG/SNMM

▲ empfohlene Qualität (auf Lager) **●** alternative Qualität (auf Lager) ■ Auslaufmodell (auf Lager bis ausverkauft)  
*recommended grade (on stock) alternative grade (on stock) discontinued model (in stock until sold out)*

Bestellcode Ordering Code	Qualität   Grades																								
	P							M								K	N	S							
	SW33105	SW22115	SW33115	SW22125	SW33125	SW22740	SW33740	SW12910	SW44115	SW12920	SW22120	SW44125	SW11425	SW22135	SW44740	SW11440	SW22705	SW22320	SW00910	SW12910	SW22410	SW11415	SW11515	SW12920	SW11420
1	2	3	4	5	6	7	8	9	10	11	12	13	14	15	16	17	18	19	20	21	22	23	24	25	
<b>SNMG-HR</b>  Schruppen Roughing	SNMG 120408-HR	■	●	■	▲	■	■										■	▲							
SNMG 120412-HR	■	●	■	▲	■	■											■	▲							
SNMG 120416-HR	■	●	■	▲	■	■											■	▲							
SNMG 150612-HR				■	▲	■																			
SNMG 150616-HR				■	▲	■																			
SNMG 190612-HR	■	●	■	▲	■	■																			
SNMG 190616-HR	■	●	■	▲	■	■																			

**NEW**

Bestellcode Ordering Code	Qualität   Grades																								
	P							M								K	N	S							
	SW33105	SW22115	SW33115	SW22125	SW33125	SW22740	SW33740	SW12910	SW44115	SW12920	SW22120	SW44125	SW11425	SW22135	SW44740	SW11440	SW22705	SW22320	SW00910	SW12910	SW22410	SW11415	SW11515	SW12920	SW11420
1	2	3	4	5	6	7	8	9	10	11	12	13	14	15	16	17	18	19	20	21	22	23	24	25	
<b>SNMM-RP</b>  Schruppen Roughing	SNMM 150608-RP		●	▲																					
SNMM 150612-RP		●	▲																						
SNMM 150616-RP		●	▲																						
SNMM 190612-RP	■	●	■	▲																					
SNMM 190616-RP	■	●	■	▲																					
SNMM 190624-RP	■	●	■	▲																					

Bestellcode Ordering Code	Qualität   Grades																								
	P							M								K	N	S							
	SW33105	SW22115	SW33115	SW22125	SW33125	SW22740	SW33740	SW12910	SW44115	SW12920	SW22120	SW44125	SW11425	SW22135	SW44740	SW11440	SW22705	SW22320	SW00910	SW12910	SW22410	SW11415	SW11515	SW12920	SW11420
1	2	3	4	5	6	7	8	9	10	11	12	13	14	15	16	17	18	19	20	21	22	23	24	25	
<b>SNMM-HY</b>  Schruppen bis Schwerzerspannung Heavy to Roughing	SNMM 190612-HY	■	●	■	▲	■																			▲
SNMM 190616-HY	■	●	■	▲	■	■																			▲
SNMM 190624-HY	■	●	■	▲	■	■																			▲
SNMM 250724-HY	■	●	■	▲	■	■																			▲
SNMM 250924-HY	■	●	■	▲	■	■																			▲

Bestellcode Ordering Code	Qualität   Grades																								
	P							M								K	N	S							
	SW33105	SW22115	SW33115	SW22125	SW33125	SW22740	SW33740	SW12910	SW44115	SW12920	SW22120	SW44125	SW11425	SW22135	SW44740	SW11440	SW22705	SW22320	SW00910	SW12910	SW22410	SW11415	SW11515	SW12920	SW11420
1	2	3	4	5	6	7	8	9	10	11	12	13	14	15	16	17	18	19	20	21	22	23	24	25	
<b>SNMM-HZ</b>  Schruppen bis Schwerzerspannung Heavy to Roughing	SNMM 190612-HZ	■	●	■	▲	■																			▲
SNMM 190616-HZ	■	●	■	▲	■	■																			▲
SNMM 190624-HZ	■	●	■	▲	■	■																			▲
SNMM 250724-HZ	■	●	■	▲	■	■																			▲
SNMM 250732-HZ			■	▲																					▲
SNMM 250924-HZ	■	●	■	▲	■	■																			▲

Ersetzt alte Qualität in neue Qualität. SW22115 wird durch SW33115 ersetzt. SW22125 wird durch SW33125 ersetzt. SW22740 wird durch SW33740 ersetzt.  
*Replaces old grade into new grade. SW22115 is replaced by SW33115. SW22125 is replaced by SW33125. SW22740 is replaced by SW33740.*

Wettbewerbs-Qualitätsvergleich siehe Seite 150-152. *Competitor grade comparison see pages 150-152.* →  
 Wettbewerbs-Spanbrechervergleich siehe Seite 154-157. *Competitor chipbreaker comparison see pages 154-157.* →

SNMG/SNMM

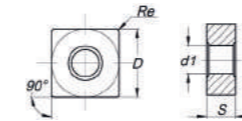

Maße Dimensions (mm)		Schnittdaten Cutting Details				Preis in €   Price in €																				
D	S	Re	d1	ap min	ap max	fn min	fn max	SW33105	SW22115	SW33115	SW22125	SW33125	SW22740	SW33740	SW22135	SW44740	SW11440	SW22705	SW22320	SW00910	SW12910	SW22410	SW11415	SW11515	SW12920	SW11420
								1	2	3	4	5	6	7	14	15	16	17	18	19	20	21	22	23	24	25
12,700	4,76	0,80	5,16	0,80	7,00	0,20	0,55	7,73	8,87	7,73	8,87	7,73	8,87					7,73	7,73							
12,700	4,76	1,20	5,16	1,00	7,00	0,25	0,70	7,73	8,87	7,73	8,87	7,73	8,87					7,73	7,73							
12,700	4,76	1,60	5,16	1,50	7,00	0,32	0,80	7,73	8,87	7,73	8,87	7,73	8,87					7,73								
15,875	6,35	1,20	6,35	1,00	8,00	0,25	0,70				16,23	18,66	16,23	18,66												
15,875	6,35	1,60	6,35	1,50	8,00	0,32	0,80				16,23	18,66	16,23	18,66												
19,050	6,35	1,20	7,94	1,00	10,00	0,25	0,70	20,55	23,64	20,55	23,64	20,55	23,64													
19,050	6,35	1,60	7,94	1,50	10,00	0,32	0,80	20,55	23,64	20,55	23,64	20,55	23,64													

Maße Dimensions (mm)		Schnittdaten Cutting Details				Preis in €   Price in €																				
D	S	Re	d1	ap min	ap max	fn min	fn max	SW33105	SW22115	SW33115	SW22125	SW33125	SW22740	SW33740	SW22135	SW44740	SW11440	SW22705	SW22320	SW00910	SW12910	SW22410	SW11415	SW11515	SW12920	SW11420
								1	2	3	4	5	6	7	14	15	16	17	18	19	20	21	22	23	24	25
15,875	6,35	0,80	6,35	1,00	8,00	0,15	0,50			18,93	18,93															
15,875	6,35	1,20	6,35	1,00	8,00	0,25	0,70			18,93	18,93															
15,875	6,35	1,60	6,35	1,00	8,00	0,35	0,90			18,93	18,93															
19,050	6,35	1,20	7,94	2,00	12,00	0,30	0,85	20,55	23,80	20,55	23,80															
19,050	6,35	1,60	7,94	2,00	12,00	0,35	1,00	20,55	23,80	20,55	23,80															
19,050	6,35	2,40	7,94	2,00	12,00	0,50	1,50	20,55	23,80	20,55	23,80															

Maße Dimensions (mm)		Schnittdaten Cutting Details				Preis in €   Price in €																				
D	S	Re	d1	ap min	ap max	fn min	fn max	SW33105	SW22115	SW33115	SW22125	SW33125	SW22740	SW33740	SW22135	SW44740	SW11440	SW22705	SW22320	SW00910	SW12910	SW22410	SW11415	SW11515	SW12920	SW11420
								1	2	3	4	5	6	7	14	15	16	17	18	19	20	21	22	23	24	25
19,050	6,35	1,20	7,94	2,00	12,00	0,35	0,90	20,55	23,80	20,55	23,80	20,55	23,80		23,80											
19,050	6,35	1,60	7,94	2,00	12,00	0,35	1,20	20,55	23,80	20,55	23,80	20,55	23,80		23,80											
19,050	6,35	2,40	7,94	2,00	12,00	0,60	1,60	20,55	23,80	20,55	23,80	20,55	23,80		23,80											
25,400	7,94	2,40	9,12	2,50	15,00	0,60	1,60	39,21	45,16	39,21	45,16	39,21	45,16		45,16											
25,400	9,52	2,40	9,12	3,00	15,00	0,60	1,60	42,73	49,22	42,73	49,22	42,73	49,22		49,22											

Maße Dimensions (mm)		Schnittdaten Cutting Details				Preis in €   Price in €																				
D	S	Re	d1	ap min	ap max	fn min	fn max	SW33105	SW22115	SW33115	SW22125	SW33125	SW22740	SW33740	SW22135	SW44740	SW11440	SW22705	SW22320	SW00910	SW12910	SW22410	SW11415	SW11515	SW12920	SW11420
								1	2	3	4	5	6	7	14	15	16	17	18	19	20	21	22	23	24	25
19,050	6,35	1,20	7,94	2,40	13,00	0,35	0,90	20,55	23,80	20,55	23,80	20,55	20,55					20,55								
19,050	6,35	1,60	7,94	2,40	13,00	0,35	1,20	20,55	23,80	20,55	23,80	20,55														

TNMA/TNMG

▲ empfohlene Qualität (auf Lager) **●** alternative Qualität (auf Lager) ■ Auslaufmodell (auf Lager bis ausverkauft)  
*recommended grade (on stock) alternative grade (on stock) discontinued model (in stock until sold out)*

Bestellcode Ordering Code	Qualität   Grades																									
	P							M								K	N	S								
	SW33105	SW22115	SW33115	SW22125	SW33125	SW22740	SW33740	SW12910	SW44115	SW12920	SW22120	SW44125	SW11425	SW22135	SW44740	SW11440	SW22705	SW22320	SW00910	SW12910	SW22410	SW11415	SW11515	SW12920	SW11420	
1	2	3	4	5	6	7	8	9	10	11	12	13	14	15	16	17	18	19	20	21	22	23	24	25		
TNMA 110304																	▲	●								
TNMA 110308																	▲	●								
TNMA 160304																	▲	●								
TNMA 160308																	▲	●								
TNMA 160404																	▲	●								
TNMA 160408																	▲	●								
TNMA 160412																	▲	●								
TNMA 160416																	▲	●								
TNMA 220404																	▲	●								
TNMA 220408																	▲	●								
TNMA 220412																	▲	●								
TNMA 220416																	▲	●								
TNMA 220432																		■								
TNMA 270608																	▲	●								
TNMA 270612																	▲	●								
TNMA 270616																	▲	●								
TNMA 330724																	▲	●								

TNMA



Schruppen  
Roughing

TNMG-MF

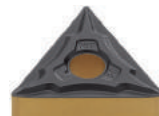

Schlichten  
Finishing

	1	2	3	4	5	6	7	8	9	10	11	12	13	14	15	16	17	18	19	20	21	22	23	24	25	
TNMG 160404-MF	●	■	▲	■	●			▲																		
TNMG 160408-MF	●	●	▲	■	●			▲																		
TNMG 160412-MF		■	▲	■	●																					
TNMG 220408-MF		■	▲																							

TNMA/TNMG



Maße Dimensions (mm)		Schnittdaten Cutting Details							Preis in €   Price in €																								
D	S	Re	d1	ap min	ap max	fn min	fn max	SW33105	SW22115	SW33115	SW22125	SW33125	SW22740	SW33740	SW12910	SW44740	SW11440	SW22705	SW22320	SW00910	SW12910	SW22410	SW11415	SW11515	SW12920	SW11420							
								1	2	3	4	5	6	7	8	15	16	17	18	19	20	21	22	23	24	25							
6,350	3,18	0,40	2,26	0,15	4,00	0,10	0,30												6,65	6,65													
6,350	3,18	0,80	2,26	0,15	4,00	0,15	0,60												6,65	6,65													
9,525	3,18	0,40	3,81	0,20	5,00	0,10	0,30												7,46	7,46													
9,525	3,18	0,80	3,81	0,20	5,00	0,15	0,60												7,46	7,46													
9,525	4,76	0,40	3,81	0,20	5,00	0,10	0,30												7,73	7,73													
9,525	4,76	0,80	3,81	0,20	7,00	0,15	0,60												7,73	7,73													
9,525	4,76	1,20	3,81	0,30	7,00	0,20	0,80												7,73	7,73													
9,525	4,76	1,60	3,81	0,30	7,00	0,20	1,00												7,73	7,73													
12,700	4,76	0,40	5,16	0,20	10,00	0,10	0,30												11,09	11,09													
12,700	4,76	0,80	5,16	0,20	10,00	0,15	0,60												11,09	11,09													
12,700	4,76	1,20	5,16	0,30	10,00	0,20	0,80												11,09	11,09													
12,700	4,76	1,60	5,16	0,30	10,00	0,20	1,00												11,09	11,09													
12,700	4,76	3,20	5,16	0,50	10,00	0,50	1,20													11,09													
15,875	6,35	0,80	6,35	0,30	12,00	0,15	0,60												20,01	20,01													
15,875	6,35	1,20	6,35	0,30	12,00	0,20	0,80												20,01	20,01													
15,875	6,35	1,60	6,35	0,30	12,00	0,20	1,00												20,01	20,01													
19,050	7,94	2,40	7,94	0,30	15,00	0,30	2,00												41,38	41,38													

	1	2	3	4	5	6	7	8	15	16	17	18	19	20	21	22	23	24	25							
9,525	4,76	0,40	3,81	0,10	1,50	0,05	0,25	8,92	7,73	8,92	7,73	8,92						7,73								
9,525	4,76	0,80	3,81	0,10	1,50	0,10	0,40	8,92	7,73	8,92	7,73	8,92						7,73								
9,525	4,76	1,20	3,81	0,20	2,50	0,15	0,60			7,73	8,92	7,73	8,92													
12,700	4,76	0,80	5,16	0,25	2,50	0,10	0,40			11,09	13,25															



Ersetzt alte Qualität in neue Qualität. SW22115 wird durch SW33115 ersetzt. SW22125 wird durch SW33125 ersetzt. SW22740 wird durch SW33740 ersetzt.  
*Replaces old grade into new grade. SW22115 is replaced by SW33115. SW22125 is replaced by SW33125. SW22740 is replaced by SW33740.*

Wettbewerbs-Qualitätsvergleich siehe Seite 150-152. [Competitor grade comparison see pages 150-152.](#)  
 Wettbewerbs-Spanbrechervergleich siehe Seite 154-157. [Competitor chipbreaker comparison see pages 154-157.](#)

Die neuen Qualitäten SW33... sind erst vollständig verfügbar wenn die Auslaufmodelle SW22... nicht mehr lagerhaltig sind.  
*The new Grades SW33... are only fully available when the discontinued models SW22... are no longer in stock.*



TNMG

▲ empfohlene Qualität (auf Lager) **●** alternative Qualität (auf Lager) ■ Auslaufmodell (auf Lager bis ausverkauft)  
*recommended grade (on stock) alternative grade (on stock) discontinued model (in stock until sold out)*

Bestellcode Ordering Code	Qualität   Grades																									
	P						M										K	N	S							
	SW33105	SW22115	SW33115	SW22125	SW33125	SW22740	SW33740	SW12910	SW44115	SW12920	SW22120	SW44125	SW11425	SW22135	SW44740	SW11440	SW22705	SW22320	SW00910	SW12910	SW22410	SW11415	SW11515	SW12920	SW11420	
1	2	3	4	5	6	7	8	9	10	11	12	13	14	15	16	17	18	19	20	21	22	23	24	25		
TNMG 160404-SF							●	▲	●		●								●						▲	
TNMG 160408-SF							●	▲	●		●								●						▲	
TNMG 160412-SF							●	▲	●		●								●						▲	
TNMG 220404-SF							●	▲	●		●								●						▲	
TNMG 220408-SF							●	▲	●		●								●						▲	
TNMG 220412-SF							●	▲	●		●								●						▲	



TNMG-SF



Mittlere Bearbeitung bis Schlichten  
*Medium to Finishing*

TNMG-LC



Mittlere Bearbeitung bis Schlichten  
*Medium to Finishing*

TNMG-MS



Mittlere Bearbeitung  
*Medium*

TNMG-SSM



Mittlere Bearbeitung  
*Medium*

TNMG



Maße Dimensions (mm)				Schnittdaten Cutting Details				Preis in €   Price in €																								
D	S	Re	d1	ap <sub>min</sub>	ap <sub>max</sub>	fn <sub>min</sub>	fn <sub>max</sub>	SW33105	SW22115	SW33115	SW22125	SW33125	SW12910	SW44115	SW12920	SW22120	SW44125	SW11425	SW22135	SW44740	SW22705	SW22320	SW00910	SW12910	SW12920	SW11420						
								1	2	3	4	5	8	9	10	11	12	13	14	15	17	18	19	20	24	25						
9,525	4,76	0,40	3,81	0,60	3,00	0,10	0,23							8,60	8,92	8,60		8,92								8,60	8,60					
9,525	4,76	0,80	3,81	0,60	3,00	0,12	0,38							8,60	8,92	8,60		8,92									8,60	8,60				
9,525	4,76	1,20	3,81	0,60	3,00	0,15	0,55							8,60	8,92	8,60		8,92									8,60	8,60				
12,700	4,76	0,40	5,16	0,60	3,00	0,10	0,35							12,71	13,25	12,71		13,25								12,71	12,71					
12,700	4,76	0,80	5,16	0,60	3,00	0,12	0,40							12,71	13,25	12,71		13,25									12,71	12,71				
12,700	4,76	1,20	5,16	0,60	3,00	0,15	0,55							12,71	13,25	12,71		13,25									12,71	12,71				

								1	2	3	4	5	8	9	10	11	12	13	14	15	17	18	19	20	24	25		
9,525	4,76	0,40	3,81	0,40	2,50	0,07	0,30	8,92	7,73	8,92	7,73	8,92																
9,525	4,76	0,80	3,81	0,40	2,50	0,10	0,40		7,73	8,92	7,73	8,92																
9,525	4,76	1,20	3,81	0,80	3,00	0,15	0,50		7,73	8,92	7,73	8,92																
12,700	4,76	0,80	5,16	0,40	3,00	0,10	0,40	11,09	13,25	11,09	13,25																	
12,700	4,76	1,20	5,16	0,80	3,50	0,15	0,50	11,09	13,25	11,09	13,25																	

								1	2	3	4	5	8	9	10	11	12	13	14	15	17	18	19	20	24	25	
9,525	4,76	0,40	3,81	0,30	3,80	0,10	0,20									7,73										8,00	7,73
9,525	4,76	0,80	3,81	0,30	3,80	0,10	0,40									7,73										8,00	7,73
9,525	4,76	1,20	3,81	0,40	3,80	0,15	0,60									7,73										8,00	7,73

								1	2	3	4	5	8	9	10	11	12	13	14	15	17	18	19	20	24	25		
9,525	4,76	0,80	3,81	1,20	6,00	0,15	0,40												8,62	8,27								
9,525	4,76	1,20	3,81	1,20	6,00	0,15	0,40												8,62	8,27								
12,700	4,76	0,80	5,16	1,20	6,00	0,15	0,40												10,41	9,99								
12,700	4,76	1,20	5,16	1,20	6,00	0,15	0,40												10,41	9,99								

Ersetzt alte Qualität in neue Qualität. SW22115 wird durch SW33115 ersetzt. SW22125 wird durch SW33125 ersetzt. SW22740 wird durch SW33740 ersetzt.  
*Replaces old grade into new grade. SW22115 is replaced by SW33115. SW22125 is replaced by SW33125. SW22740 is replaced by SW33740.*

Wettbewerbs-Qualitätsvergleich siehe Seite 150-152. *Competitor grade comparison see pages 150-152.* →  
 Wettbewerbs-Spanbrechervergleich siehe Seite 154-157. *Competitor chipbreaker comparison see pages 154-157.* →

Die neuen Qualitäten SW33... sind erst vollständig verfügbar wenn die Auslaufmodelle SW22... nicht mehr lagerhaltig sind.  
*The new Grades SW33... are only fully available when the discontinued models SW22... are no longer in stock.*

TNMG

▲ empfohlene Qualität (auf Lager) **●** alternative Qualität (auf Lager) ■ Auslaufmodell (auf Lager bis ausverkauft)  
*recommended grade (on stock) alternative grade (on stock) discontinued model (in stock until sold out)*

Bestellcode Ordering Code	Qualität   Grades																								
	P							M								K	N	S							
	SW33105	SW22115	SW33115	SW22125	SW33125	SW22740	SW33740	SW12910	SW44115	SW12920	SW22120	SW44125	SW11425	SW22135	SW44740	SW11440	SW22705	SW22320	SW00910	SW12910	SW22410	SW11415	SW11515	SW12920	SW11420
TNMG 160308-MR	■	●	■	▲																					
TNMG 160404-MR	■	●	■	▲	■	●																			
TNMG 160408-MR	■	●	■	▲	■	●																			
TNMG 160412-MR	■	●	■	▲	■	●																			
TNMG 220404-MR	■	●	■	▲	■	●																			
TNMG 220408-MR	■	●	■	▲	■	●																			
TNMG 220412-MR	■	●	■	▲	■	●																			
TNMG 220416-MR			■	▲	■	●																			

TNMG-MR

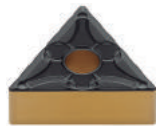

Mittlere Bearbeitung  
Medium

NEW

TNMG-PM



Mittlere Bearbeitung  
Medium

	1	2	3	4	5	6	7	8	9	10	11	12	13	14	15	16	17	18	19	20	21	22	23	24	25	
TNMG 160404-PM	●		●		▲																					
TNMG 160408-PM	●		●		▲																					
TNMG 160412-PM	●		●		▲																					
TNMG 160416-PM			●		▲																					
TNMG 220404-PM			●		▲																					
TNMG 220408-PM			●		▲																					
TNMG 220412-PM			●		▲																					
TNMG 220416-PM			●		▲																					

TNMG-ST



Mittlere Bearbeitung  
Medium

	1	2	3	4	5	6	7	8	9	10	11	12	13	14	15	16	17	18	19	20	21	22	23	24	25	
TNMG 110304-ST																		■								
TNMG 110308-ST																		▲								
TNMG 160304-ST																		▲								
TNMG 160308-ST																		▲								
TNMG 160404-ST																		●	▲							
TNMG 160408-ST																		●	▲							
TNMG 160412-ST																		●	▲							
TNMG 160416-ST																		●	▲							
TNMG 220404-ST																		●	▲							
TNMG 220408-ST																		●	▲							
TNMG 220412-ST																		●	▲							
TNMG 220416-ST																		●	▲							



Ersetzt alte Qualität in neue Qualität. SW22115 wird durch SW33115 ersetzt. SW22125 wird durch SW33125 ersetzt. SW22740 wird durch SW33740 ersetzt.  
*Replaces old grade into new grade. SW22115 is replaced by SW33115. SW22125 is replaced by SW33125. SW22740 is replaced by SW33740.*

Wettbewerbs-Qualitätsvergleich siehe Seite 150-152. *Competitor grade comparison see pages 150-152.* →

Wettbewerbs-Spanbrechervergleich siehe Seite 154-157. *Competitor chipbreaker comparison see pages 154-157.* →

TNMG



Maße Dimensions (mm)		Schnittdaten Cutting Details				Preis in €   Price in €																				
D	S	Re	d1	ap min	ap max	fn min	fn max	SW33105	SW22115	SW33115	SW22125	SW33125	SW22740	SW33740	SW22135	SW44740	SW11440	SW22705	SW22320	SW00910	SW12910	SW22410	SW11415	SW11515	SW12920	SW11420
9,525	3,18	0,80	3,81	0,30	5,00	0,15	0,50		6,92	8,00	6,92	8,00														
9,525	4,76	0,40	3,81	0,40	5,00	0,10	0,30		7,73	8,92	7,73	8,92	7,73	8,92												
9,525	4,76	0,80	3,81	0,50	5,00	0,15	0,50		7,73	8,92	7,73	8,92	7,73	8,92												
9,525	4,76	1,20	3,81	0,80	5,00	0,18	0,60		7,73	8,92	7,73	8,92	7,73	8,92												
12,700	4,76	0,40	5,16	0,40	6,60	0,10	0,30		11,09	13,25	11,09	13,25	11,09	13,25												
12,700	4,76	0,80	5,16	0,50	6,60	0,15	0,50		11,09	13,25	11,09	13,25	11,09	13,25												
12,700	4,76	1,20	5,16	0,80	6,60	0,18	0,60		11,09	13,25	11,09	13,25	11,09	13,25												
12,700	4,76	1,60	5,16	1,00	6,60	0,23	0,70				11,09	13,25	11,09	13,25												

	1	2	3	4	5	6	7	14	15	16	17	18	19	20	21	22	23	24	25							
9,525	4,76	0,40	3,81	0,40	5,00	0,10	0,30	8,92	8,92	8,92																
9,525	4,76	0,80	3,81	0,50	5,00	0,15	0,50	8,92	8,92	8,92																
9,525	4,76	1,20	3,81	0,80	5,00	0,18	0,60	8,92	8,92	8,92																
9,525	4,76	1,60	3,81	1,00	5,00	0,23	0,65		8,92	8,92																
12,700	4,76	0,40	5,16	0,40	6,60	0,10	0,30		13,25	13,25																
12,700	4,76	0,80	5,16	0,50	6,60	0,15	0,50		13,25	13,25																
12,700	4,76	1,20	5,16	0,80	6,60	0,18	0,60		13,25	13,25																
12,700	4,76	1,60	5,16	1,00	6,60	0,23	0,60		13,25	13,25																

	1	2	3	4	5	6	7	14	15	16	17	18	19	20	21	22	23	24	25							
6,350	3,18	0,40	2,26	0,15	4,50	0,15	0,30													5,52						
6,350	3,18	0,80	2,26	0,15	4,50	0,15	0,50													5,52						
9,525	3,18	0,40	3,81	0,20	5,50	0,15	0,30													6,92						
9,525	3,18	0,80	3,81	0,20	5,50	0,15	0,50													6,92						
9,525	4,76	0,40	3,81	0,20	5,50	0,15	0,30													7,73	7,73					
9,525	4,76	0,80	3,81	0,20	5,50	0,15	0,50													7,73	7,73					
9,525	4,76	1,20	3,81	0,30	5,50	0,15	0,60													7,73	7,73					
9,525	4,76	1,60	3,81	0,30	5,50	0,15	0,60													7,73	7,73					
12,700	4,76	0,40	5,16	0,20	8,00	0,15	0,30													11,09	11,09					
12,700	4,76	0,80	5,16	0,20	8,00	0,15	0,50													11,09	11,09					
12,700	4,76	1,20	5,16	0,30	8,00	0,15	0,60													11,09	11,09					
12,700	4,76	1,60	5,16	0,30	8,00	0,20	0,70													11,09	11,09					

Die neuen Qualitäten SW33... sind erst vollständig verfügbar wenn die Auslaufmodelle SW22... nicht mehr lagerhaltig sind.  
*The new Grades SW33... are only fully available when the discontinued models SW22... are no longer in stock.*

TNMG/TNMX

▲ empfohlene Qualität (auf Lager) **recommended grade (on stock)**  
 ● alternative Qualität (auf Lager) **alternative grade (on stock)**  
 ■ Auslaufmodell (auf Lager bis ausverkauft) **discontinued model (in stock until sold out)**

TNMG-MW



Mittlere Bearbeitung Wiper  
 Medium Wiper

Bestellcode Ordering Code	Qualität   Grades																								
	P							M								K	N	S							
	SW33105	SW22115	SW33115	SW22125	SW33125	SW22740	SW33740	SW12910	SW44115	SW12920	SW22120	SW44125	SW11425	SW22135	SW44740	SW11440	SW22705	SW22320	SW00910	SW12910	SW22410	SW11415	SW11515	SW12920	SW11420
TNMG 160408-MW	▲	▲	▲	▲	▲	▲											▲								
TNMG 160412-MW	▲	▲	▲	▲	▲	▲											▲								

TNMG-SS



Schruppen bis mittlere Bearbeitung  
 Roughing to Medium

	1	2	3	4	5	6	7	8	9	10	11	12	13	14	15	16	17	18	19	20	21	22	23	24	25
TNMG 160404-SS								●	●	●		▲								●				▲	
TNMG 160408-SS								●	●	●		▲								●				▲	
TNMG 160412-SS								●	●	●		▲								●				▲	
TNMG 220408-SS								●	●	●		▲								●				▲	
TNMG 220412-SS									●			▲												▲	

TNMG-HR

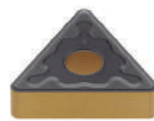

Schruppen  
 Roughing

	1	2	3	4	5	6	7	8	9	10	11	12	13	14	15	16	17	18	19	20	21	22	23	24	25
TNMG 160408-HR	●	▲	●	▲	▲	●	●										●	▲							
TNMG 160412-HR		▲	●	▲	▲	●	●										●	▲							
TNMG 220408-HR		▲	●	▲	▲	●	●										●	▲							
TNMG 220412-HR		▲	●	▲	▲	●	●										●	▲							
TNMG 220416-HR		▲	●	▲	▲	●	●										●	▲							
TNMG 270612-HR				▲	▲	●	●																		
TNMG 270616-HR					▲	●	●																		

NEW

TNMX-01



Mittlere Bearbeitung bis Schlichten  
 Medium to Finishing

	1	2	3	4	5	6	7	8	9	10	11	12	13	14	15	16	17	18	19	20	21	22	23	24	25
TNMX 160404-L01	▲	●	▲	▲																					
TNMX 160404-R01	▲	●	▲	▲																					
TNMX 160408-L01	▲	●	▲	▲																					
TNMX 160408-R01	▲	●	▲	▲																					



Ersetzt alte Qualität in neue Qualität. SW22115 wird durch SW33115 ersetzt. SW22125 wird durch SW33125 ersetzt. SW22740 wird durch SW33740 ersetzt.  
 Replaces old grade into new grade. SW22115 is replaced by SW33115. SW22125 is replaced by SW33125. SW22740 is replaced by SW33740.

Wettbewerbs-Qualitätsvergleich siehe Seite 150-152. Competitor grade comparison see pages 150-152. →

Wettbewerbs-Spanbrechervergleich siehe Seite 154-157. Competitor chipbreaker comparison see pages 154-157. →

TNMG/TNMX

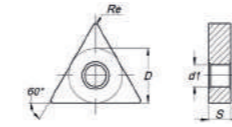

Maße Dimensions (mm)				Schnittdaten Cutting Details				Preis in €   Price in €																								
D	S	Re	d1	ap min	ap max	fn min	fn max	SW33105	SW22115	SW33115	SW22125	SW33125	SW22740	SW33740	SW12910	SW44115	SW12920	SW22120	SW44125	SW44740	SW22705	SW22320	SW00910	SW12910	SW12920	SW11420						
								1	2	3	4	5	6	7	8	9	10	11	12	15	17	18	19	20	24	25						
9,525	4,76	0,80	3,81	0,50	4,50	0,15	0,60		8,60	9,90	8,60	9,90	8,60	9,90												8,60						
9,525	4,76	1,20	3,81	0,50	5,00	0,25	0,90		8,60	9,90	8,60	9,90	8,60	9,90													8,60					

								1	2	3	4	5	6	7	8	9	10	11	12	15	17	18	19	20	24	25
9,525	4,76	0,40	3,81	0,50	4,00	0,10	0,30									8,60	8,92	8,60		8,92	8,92				8,60	8,60
9,525	4,76	0,80	3,81	0,50	4,80	0,12	0,45									8,60	8,92	8,60		8,92	8,92				8,60	8,60
9,525	4,76	1,20	3,81	0,50	4,80	0,15	0,60									8,60	8,92	8,60		8,92	8,90				8,60	8,60
12,700	4,76	0,80	5,16	0,50	6,60	0,12	0,45									12,71	13,25	12,71		13,25	13,25				12,71	12,71
12,700	4,76	1,20	5,16	0,50	6,60	0,15	0,60													12,71	13,25					12,71

								1	2	3	4	5	6	7	8	9	10	11	12	15	17	18	19	20	24	25
9,525	4,76	0,80	3,81	0,80	6,00	0,20	0,55	8,92	7,73	8,92	7,73	8,92	7,73	8,92											7,73	7,73
9,525	4,76	1,20	3,81	1,00	6,00	0,25	0,70		7,73	8,92	7,73	8,92	7,73	8,92											7,73	7,73
12,700	4,76	0,80	5,16	0,80	6,50	0,20	0,55	11,09	13,25	11,09	13,25	11,09	13,25											11,09	11,09	
12,700	4,76	1,20	5,16	1,00	7,00	0,25	0,70	11,09	13,25	11,09	13,25	11,09	13,25											11,09	11,09	
12,700	4,76	1,60	5,16	1,50	7,00	0,25	0,90	11,09	13,25	11,09	13,25	11,09	13,25											11,09	11,09	
15,875	6,35	1,20	6,35	2,00	10,00	0,25	0,70					21,63	24,88	21,63	24,88											
15,875	6,35	1,60	6,35	2,00	10,00	0,35	0,90							21,63	24,88											

								1	2	3	4	5	6	7	8	9	10	11	12	15	17	18	19	20	24	25
9,525	4,76	0,40	3,81	1,00	3,50	0,12	0,30		7,73	8,92	7,73	8,92														
9,525	4,76	0,40	3,81	1,00	3,50	0,12	0,30		7,73	8,92	7,73	8,92														
9,525	4,76	0,80	3,81	1,30	3,50	0,15	0,50		7,73	8,92	7,73	8,92														
9,525	4,76	0,80	3,81	1,30	3,50	0,15	0,50		7,73	8,92	7,73	8,92														

Die neuen Qualitäten SW33... sind erst vollständig verfügbar wenn die Auslaufmodelle SW22... nicht mehr lagerhaltig sind.  
 The new Grades SW33... are only fully available when the discontinued models SW22... are no longer in stock.

VNMA/VNMG

▲ empfohlene Qualität (auf Lager) **recommended grade (on stock)**  
 ● alternative Qualität (auf Lager) **alternative grade (on stock)**  
 ■ Auslaufmodell (auf Lager bis ausverkauft) **discontinued model (in stock until sold out)**

Bestellcode Ordering Code	Qualität   Grades																								
	P							M								K	N	S							
	SW33105	SW22115	SW33115	SW22125	SW33125	SW22740	SW33740	SW12910	SW44115	SW12920	SW22120	SW44125	SW11425	SW22135	SW44740	SW11440	SW22705	SW22320	SW00910	SW12910	SW22410	SW11415	SW11515	SW12920	SW11420
VNMA 160404	1	2	3	4	5	6	7	8	9	10	11	12	13	14	15	16	17	18	19	20	21	22	23	24	25
VNMA 160408																	▲	●							

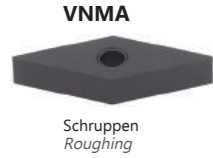

Bestellcode Ordering Code	Qualität   Grades																								
	P							M								K	N	S							
	SW33105	SW22115	SW33115	SW22125	SW33125	SW22740	SW33740	SW12910	SW44115	SW12920	SW22120	SW44125	SW11425	SW22135	SW44740	SW11440	SW22705	SW22320	SW00910	SW12910	SW22410	SW11415	SW11515	SW12920	SW11420
VNMG 160404-MF	1	2	3	4	5	6	7	8	9	10	11	12	13	14	15	16	17	18	19	20	21	22	23	24	25
VNMG 160408-MF	●	■	▲	■				▲																	

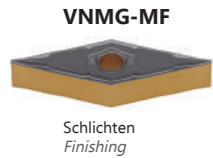

**NEW**

Bestellcode Ordering Code	Qualität   Grades																								
	P							M								K	N	S							
	SW33105	SW22115	SW33115	SW22125	SW33125	SW22740	SW33740	SW12910	SW44115	SW12920	SW22120	SW44125	SW11425	SW22135	SW44740	SW11440	SW22705	SW22320	SW00910	SW12910	SW22410	SW11415	SW11515	SW12920	SW11420
VNMG 160404-SF								●	▲	●	●								●				▲		
VNMG 160408-SF								●	▲	●	●								●				▲		
VNMG 160412-SF								●	▲	●	●								●				▲		



Bestellcode Ordering Code	Qualität   Grades																								
	P							M								K	N	S							
	SW33105	SW22115	SW33115	SW22125	SW33125	SW22740	SW33740	SW12910	SW44115	SW12920	SW22120	SW44125	SW11425	SW22135	SW44740	SW11440	SW22705	SW22320	SW00910	SW12910	SW22410	SW11415	SW11515	SW12920	SW11420
VNMG 160408-LC	1	2	3	4	5	6	7	8	9	10	11	12	13	14	15	16	17	18	19	20	21	22	23	24	25
	■	▲	■	●																					



Bestellcode Ordering Code	Qualität   Grades																								
	P							M								K	N	S							
	SW33105	SW22115	SW33115	SW22125	SW33125	SW22740	SW33740	SW12910	SW44115	SW12920	SW22120	SW44125	SW11425	SW22135	SW44740	SW11440	SW22705	SW22320	SW00910	SW12910	SW22410	SW11415	SW11515	SW12920	SW11420
VNMG 160404-MS											▲								▲				▲		
VNMG 160408-MS											▲								▲				▲		



Ersetzt alte Qualität in neue Qualität. SW22115 wird durch SW33115 ersetzt. SW22125 wird durch SW33125 ersetzt. SW22740 wird durch SW33740 ersetzt.  
 Replaces old grade into new grade. SW22115 is replaced by SW33115. SW22125 is replaced by SW33125. SW22740 is replaced by SW33740.

Wettbewerbs-Qualitätsvergleich siehe Seite 150-152. Competitor grade comparison see pages 150-152. →  
 Wettbewerbs-Spanbrechervergleich siehe Seite 154-157. Competitor chipbreaker comparison see pages 154-157. →

VNMA/VNMG

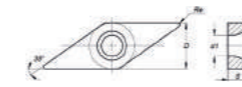

Maße Dimensions (mm)		Schnittdaten Cutting Details				Preis in €   Price in €																				
D	S	Re	d1	ap <sub>min</sub>	ap <sub>max</sub>	fn <sub>min</sub>	fn <sub>max</sub>	SW33105	SW22115	SW33115	SW22125	SW33125	SW12910	SW44115	SW12920	SW22120	SW44125	SW22705	SW22320	SW00910	SW12910	SW22410	SW11415	SW11515	SW12920	SW11420
9,525	4,76	0,40	3,81	0,10	3,30	0,08	0,25												10,76	10,76						
9,525	4,76	0,80	3,81	0,10	3,30	0,10	0,50												10,76	10,76						

Maße Dimensions (mm)		Schnittdaten Cutting Details				Preis in €   Price in €																				
D	S	Re	d1	ap <sub>min</sub>	ap <sub>max</sub>	fn <sub>min</sub>	fn <sub>max</sub>	SW33105	SW22115	SW33115	SW22125	SW33125	SW12910	SW44115	SW12920	SW22120	SW44125	SW22705	SW22320	SW00910	SW12910	SW22410	SW11415	SW11515	SW12920	SW11420
9,525	4,76	0,40	3,81	0,10	1,50	0,05	0,25		10,76	12,44	10,76		10,76													
9,525	4,76	0,80	3,81	0,10	1,50	0,10	0,40	12,44	10,76	12,44	10,76		10,76													

Maße Dimensions (mm)		Schnittdaten Cutting Details				Preis in €   Price in €																				
D	S	Re	d1	ap <sub>min</sub>	ap <sub>max</sub>	fn <sub>min</sub>	fn <sub>max</sub>	SW33105	SW22115	SW33115	SW22125	SW33125	SW12910	SW44115	SW12920	SW22120	SW44125	SW22705	SW22320	SW00910	SW12910	SW22410	SW11415	SW11515	SW12920	SW11420
9,525	4,76	0,40	3,81	0,60	3,00	0,10	0,23						12,17	12,44	12,17		12,44					12,17			12,17	
9,525	4,76	0,80	3,81	0,60	3,00	0,12	0,38						12,17	12,44	12,17		12,44					12,17			12,17	
9,525	4,76	1,20	3,81	0,60	3,00	0,15	0,55						12,17	12,44	12,17		12,44					12,17			12,17	

Maße Dimensions (mm)		Schnittdaten Cutting Details				Preis in €   Price in €																				
D	S	Re	d1	ap <sub>min</sub>	ap <sub>max</sub>	fn <sub>min</sub>	fn <sub>max</sub>	SW33105	SW22115	SW33115	SW22125	SW33125	SW12910	SW44115	SW12920	SW22120	SW44125	SW22705	SW22320	SW00910	SW12910	SW22410	SW11415	SW11515	SW12920	SW11420
9,525	4,76	0,80	3,81	0,35	2,00	0,08	0,35		10,76	12,44	10,76	12,44														

Maße Dimensions (mm)		Schnittdaten Cutting Details				Preis in €   Price in €																				
D	S	Re	d1	ap <sub>min</sub>	ap <sub>max</sub>	fn <sub>min</sub>	fn <sub>max</sub>	SW33105	SW22115	SW33115	SW22125	SW33125	SW12910	SW44115	SW12920	SW22120	SW44125	SW22705	SW22320	SW00910	SW12910	SW22410	SW11415	SW11515	SW12920	SW11420
9,525	4,76	0,40	3,81	0,20	4,00	0,10	0,20								10,76						11,13				10,76	
9,525	4,76	0,80	3,81	0,20	4,00	0,15	0,40								10,76						11,13				10,76	

Die neuen Qualitäten SW33... sind erst vollständig verfügbar wenn die Auslaufmodelle SW22... nicht mehr lagerhaltig sind.  
 The new Grades SW33... are only fully available when the discontinued models SW22... are no longer in stock.

VNMG

▲ empfohlene Qualität (auf Lager) **recommended grade (on stock)**  
 ● alternative Qualität (auf Lager) **alternative grade (on stock)**  
 ■ Auslaufmodell (auf Lager bis ausverkauft) **discontinued model (in stock until sold out)**

Bestellcode Ordering Code	Qualität   Grades																								
	P							M								K	N	S							
	SW33105	SW22115	SW33115	SW22125	SW33125	SW22740	SW33740	SW12910	SW44115	SW12920	SW22120	SW44125	SW11425	SW22135	SW44740	SW11440	SW22705	SW22320	SW00910	SW12910	SW22410	SW11415	SW11515	SW12920	SW11420

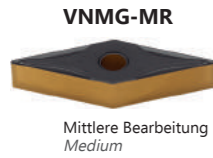

	1	2	3	4	5	6	7	8	9	10	11	12	13	14	15	16	17	18	19	20	21	22	23	24	25
VNMG 160404-MR	■	●	■	▲	■	●																			
VNMG 160408-MR	●	●	●	▲	■	●																			
VNMG 220408-MR	■	●	■	▲	■	●																			



	1	2	3	4	5	6	7	8	9	10	11	12	13	14	15	16	17	18	19	20	21	22	23	24	25
VNMG 160404-PM	●		●		▲																				
VNMG 160408-PM	●		●		▲																				



	1	2	3	4	5	6	7	8	9	10	11	12	13	14	15	16	17	18	19	20	21	22	23	24	25
VNMG 160404-ST																	●	▲							
VNMG 160408-ST																	●	▲							

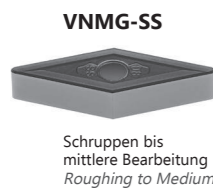

	1	2	3	4	5	6	7	8	9	10	11	12	13	14	15	16	17	18	19	20	21	22	23	24	25
VNMG 160404-SS								●	●	▲										●			▲		
VNMG 160408-SS								●	●	▲										●			▲		

Ersetzt alte Qualität in neue Qualität. SW22115 wird durch SW33115 ersetzt. SW22125 wird durch SW33125 ersetzt. SW22740 wird durch SW33740 ersetzt.  
 Replaces old grade into new grade. SW22115 is replaced by SW33115. SW22125 is replaced by SW33125. SW22740 is replaced by SW33740.

Wettbewerbs-Qualitätsvergleich siehe Seite 150-152. Competitor grade comparison see pages 150-152. →  
 Wettbewerbs-Spanbrechervergleich siehe Seite 154-157. Competitor chipbreaker comparison see pages 154-157. →

VNMG

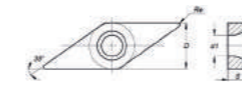

Maße Dimensions (mm)		Schnittdaten Cutting Details				Preis in €   Price in €																				
D	S	Re	d1	ap min	ap max	fn min	fn max	SW33105	SW22115	SW33115	SW22125	SW33125	SW22740	SW33740	SW12910	SW44115	SW12920	SW22120	SW44125	SW22705	SW22320	SW00910	SW12910	SW22410	SW12920	SW11420
9,525	4,76	0,40	3,81	1,00	4,00	0,10	0,30	10,76	12,44	10,76	12,44	10,76	12,44													
9,525	4,76	0,80	3,81	1,00	4,00	0,15	0,50	10,76	12,44	10,76	12,44	10,76	12,44													
12,700	4,76	0,80	5,16	1,50	5,00	0,15	0,50	13,79	15,90	13,79	15,90	13,79	15,90													

Maße Dimensions (mm)		Schnittdaten Cutting Details				Preis in €   Price in €																				
D	S	Re	d1	ap min	ap max	fn min	fn max	SW33105	SW22115	SW33115	SW22125	SW33125	SW22740	SW33740	SW12910	SW44115	SW12920	SW22120	SW44125	SW22705	SW22320	SW00910	SW12910	SW22410	SW12920	SW11420
9,525	4,76	0,40	3,81	1,00	4,00	0,10	0,30	12,44		12,44		12,44														
9,525	4,76	0,80	3,81	1,00	4,00	0,15	0,50	12,44		12,44		12,44														

Maße Dimensions (mm)		Schnittdaten Cutting Details				Preis in €   Price in €																				
D	S	Re	d1	ap min	ap max	fn min	fn max	SW33105	SW22115	SW33115	SW22125	SW33125	SW22740	SW33740	SW12910	SW44115	SW12920	SW22120	SW44125	SW22705	SW22320	SW00910	SW12910	SW22410	SW12920	SW11420
9,525	4,76	0,40	3,81	0,20	3,50	0,15	0,40																			
9,525	4,76	0,80	3,81	0,30	3,50	0,15	0,50																			

Maße Dimensions (mm)		Schnittdaten Cutting Details				Preis in €   Price in €																				
D	S	Re	d1	ap min	ap max	fn min	fn max	SW33105	SW22115	SW33115	SW22125	SW33125	SW22740	SW33740	SW12910	SW44115	SW12920	SW22120	SW44125	SW22705	SW22320	SW00910	SW12910	SW22410	SW12920	SW11420
9,525	4,76	0,40	3,81	0,50	4,00	0,10	0,30																			
9,525	4,76	0,80	3,81	0,50	4,00	0,12	0,45																			

Die neuen Qualitäten SW33... sind erst vollständig verfügbar wenn die Auslaufmodelle SW22... nicht mehr lagerhaltig sind.  
 The new Grades SW33... are only fully available when the discontinued models SW22... are no longer in stock.



WNGG/WNMA

▲ empfohlene Qualität (auf Lager) **●** alternative Qualität (auf Lager) ■ Auslaufmodell (auf Lager bis ausverkauft)  
*recommended grade (on stock) alternative grade (on stock) discontinued model (in stock until sold out)*

Bestellcode Ordering Code	Qualität   Grades																								
	P							M								K	N	S							
	SW33105	SW22115	SW33115	SW22125	SW33125	SW22740	SW33740	SW12910	SW44115	SW12920	SW22120	SW44125	SW11425	SW22135	SW44740	SW11440	SW22705	SW22320	SW00910	SW12910	SW22410	SW11415	SW11515	SW12920	SW11420

WNGG-FSM



Schlichten  
Finishing

	1	2	3	4	5	6	7	8	9	10	11	12	13	14	15	16	17	18	19	20	21	22	23	24	25
WNGG 060408-FSM																									▲
WNGG 080404-FSM																									▲
WNGG 080408-FSM																									▲
WNGG 080412-FSM																									▲

WNGG-MSS



Mittlere Bearbeitung  
Medium

	1	2	3	4	5	6	7	8	9	10	11	12	13	14	15	16	17	18	19	20	21	22	23	24	25
WNGG 080404-MSS																									▲
WNGG 080408-MSS																									▲
WNGG 080412-MSS																									▲

WNMA



Schruppen  
Roughing

	1	2	3	4	5	6	7	8	9	10	11	12	13	14	15	16	17	18	19	20	21	22	23	24	25
WNMA 060408																	▲	●							
WNMA 080404																	▲	●							
WNMA 080408																	▲	●							
WNMA 080412																	▲	●							
WNMA 080416																	▲	●							



Ersetzt alte Qualität in neue Qualität. SW22115 wird durch SW33115 ersetzt. SW22125 wird durch SW33125 ersetzt. SW22740 wird durch SW33740 ersetzt.  
*Replaces old grade into new grade. SW22115 is replaced by SW33115. SW22125 is replaced by SW33125. SW22740 is replaced by SW33740.*

Wettbewerbs-Qualitätsvergleich siehe Seite 150-152. *Competitor grade comparison see pages 150-152.* →

Wettbewerbs-Spanbrechervergleich siehe Seite 154-157. *Competitor chipbreaker comparison see pages 154-157.* →

WNGG/WNMA

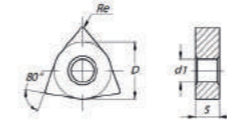

Maße Dimensions (mm)		Schnittdaten Cutting Details				Preis in €   Price in €																				
D	S	Re	d1	ap min	ap max	f min	f max	SW33105	SW22115	SW44115	SW12920	SW22120	SW44125	SW11425	SW22135	SW44740	SW11440	SW22705	SW22320	SW00910	SW12910	SW22410	SW11415	SW11515	SW12920	SW11420
9,525	4,76	0,80	3,81	0,50	4,00	0,06	0,26																			
12,700	4,76	0,40	5,16	0,50	4,00	0,06	0,26																			11,47
12,700	4,76	0,80	5,16	0,50	4,00	0,06	0,26																			14,08
12,700	4,76	1,20	5,16	0,50	4,00	0,06	0,26																			14,08

	1	2	9	10	11	12	13	14	15	16	17	18	19	20	21	22	23	24	25						
12,700	4,76	0,40	5,16	1,00	3,50	0,10	0,32																		14,08
12,700	4,76	0,80	5,16	1,00	3,50	0,10	0,32																		14,08
12,700	4,76	1,20	5,16	1,00	3,50	0,10	0,32																		14,08

	1	2	9	10	11	12	13	14	15	16	17	18	19	20	21	22	23	24	25						
9,525	4,76	0,80	3,81	0,20	4,00	0,15	0,60									7,19	7,19								
12,700	4,76	0,40	5,16	0,20	5,00	0,15	0,30									8,87	8,87								
12,700	4,76	0,80	5,16	0,20	5,00	0,15	0,60									8,87	8,87								
12,700	4,76	1,20	5,16	0,30	5,00	0,20	0,80									8,87	8,87								
12,700	4,76	1,60	5,16	0,30	5,00	0,20	1,00									8,87	8,87								

Die neuen Qualitäten SW33... sind erst vollständig verfügbar wenn die Auslaufmodelle SW22... nicht mehr lagerhaltig sind.  
*The new Grades SW33... are only fully available when the discontinued models SW22... are no longer in stock.*

WNMG

▲ empfohlene Qualität (auf Lager) **●** alternative Qualität (auf Lager) ■ Auslaufmodell (auf Lager bis ausverkauft)  
*recommended grade (on stock) alternative grade (on stock) discontinued model (in stock until sold out)*

Bestellcode Ordering Code	Qualität   Grades																								
	P							M								K	N	S							
	SW33105	SW22115	SW33115	SW22125	SW33125	SW22740	SW33740	SW12910	SW44115	SW12920	SW22120	SW44125	SW11425	SW22135	SW44740	SW11440	SW22705	SW22320	SW00910	SW12910	SW22410	SW11415	SW11515	SW12920	SW11420
1	2	3	4	5	6	7	8	9	10	11	12	13	14	15	16	17	18	19	20	21	22	23	24	25	
WNMG 06T304-MF	■	▲	■	●																					
WNMG 06T308-MF	■	▲	■	●																					
WNMG 06T312-MF	■	▲	■	●																					
WNMG 060404-MF	■	▲	■	●																					
WNMG 060408-MF	■	▲	■	●																					
WNMG 060412-MF	■	▲	■	●																					
WNMG 080404-MF	■	▲	■	●			▲																		
WNMG 080408-MF	●	■	▲	■	●		▲																		
WNMG 080412-MF	■	▲	■	●																					

WNMG-MF

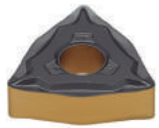

Schlichten  
Finishing

WNMG-SFSM



Schlichten  
Finishing

	1	2	3	4	5	6	7	8	9	10	11	12	13	14	15	16	17	18	19	20	21	22	23	24	25
WNMG 060404-SFSM														▲											
WNMG 080404-SFSM													▲	▲											
WNMG 080408-SFSM													▲	▲											

NEW

WNMG-SF

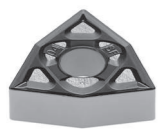

Mittlere Bearbeitung  
bis Schlichten  
Medium to Finishing

	1	2	3	4	5	6	7	8	9	10	11	12	13	14	15	16	17	18	19	20	21	22	23	24	25
WNMG 060404-SF								●	▲	●		●								●				▲	
WNMG 060408-SF								●	▲	●		●								●				▲	
WNMG 060412-SF								●	▲	●		●								●				▲	
WNMG 080404-SF								●	▲	●										●				▲	
WNMG 080408-SF								●	▲	●										●				▲	
WNMG 080412-SF								●	▲	●		●								●				▲	

WNMG-LC



Mittlere Bearbeitung  
bis Schlichten  
Medium to Finishing

	1	2	3	4	5	6	7	8	9	10	11	12	13	14	15	16	17	18	19	20	21	22	23	24	25
WNMG 080408-LC	●	■	▲	■	●																				



Ersetzt alte Qualität in neue Qualität. SW22115 wird durch SW33115 ersetzt. SW22125 wird durch SW33125 ersetzt. SW22740 wird durch SW33740 ersetzt.  
*Replaces old grade into new grade. SW22115 is replaced by SW33115. SW22125 is replaced by SW33125. SW22740 is replaced by SW33740.*

Wettbewerbs-Qualitätsvergleich siehe Seite 150-152. [Competitor grade comparison see pages 150-152.](#)  
 Wettbewerbs-Spanbrechervergleich siehe Seite 154-157. [Competitor chipbreaker comparison see pages 154-157.](#)

WNMG

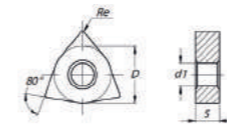

Maße Dimensions (mm)		Schnittdaten Cutting Details				Preis in €   Price in €																				
D	S	Re	d1	ap min	ap max	fn min	fn max	SW33105	SW22115	SW33115	SW22125	SW33125	SW33740	SW12910	SW44115	SW12920	SW22120	SW44125	SW11425	SW22135	SW12910	SW22410	SW11415	SW11515	SW12920	SW11420
								1	2	3	4	5	7	8	9	10	11	12	13	14	20	21	22	23	24	25
9,525	3,97	0,40	3,81	0,10	1,50	0,05	0,30		7,19	8,28	7,19	8,28														
9,525	3,97	0,80	3,81	0,10	1,50	0,10	0,40		7,19	8,28	7,19	8,28														
9,525	3,97	1,20	3,81	0,15	1,50	0,15	0,60		7,19	8,28	7,19	8,28														
9,525	4,76	0,40	3,81	0,10	1,50	0,05	0,30		7,19	8,28	7,19	8,28														
9,525	4,76	0,80	3,81	0,10	1,50	0,10	0,40		7,19	8,28	7,19	8,28														
9,525	4,76	1,20	3,81	0,15	1,50	0,15	0,60		7,19	8,28	7,19	8,28														
12,700	4,76	0,40	5,16	0,10	2,00	0,05	0,30		8,87	10,22	8,87	10,22		8,87												
12,700	4,76	0,80	5,16	0,10	2,00	0,10	0,40	10,22	8,87	10,22	8,87	10,22		8,87												
12,700	4,76	1,20	5,16	0,15	2,00	0,15	0,60		8,87	10,22	8,87	10,22														

	1	2	3	4	5	7	8	9	10	11	12	13	14	20	21	22	23	24	25						
9,525	4,76	0,40	3,81	0,50	4,00	0,08	0,32													8,17					
12,700	4,76	0,40	5,16	0,50	4,00	0,08	0,32													9,64	9,25				
12,700	4,76	0,80	5,16	0,50	4,00	0,08	0,32													9,64	9,25				

	1	2	3	4	5	7	8	9	10	11	12	13	14	20	21	22	23	24	25					
9,525	4,76	0,40	3,81	0,60	3,00	0,10	0,23							7,73	8,28	7,73		8,28			7,73			7,73
9,525	4,76	0,80	3,81	0,60	3,00	0,12	0,38							7,73	8,28	7,73		8,28			7,73			7,73
9,525	4,76	1,20	3,81	0,60	3,00	0,15	0,55							7,73	8,28	7,73		8,28			7,73			7,73
12,700	4,76	0,40	5,16	0,60	3,00	0,10	0,23							9,41	10,22	9,41					9,41			9,41
12,700	4,76	0,80	5,16	0,60	3,00	0,12	0,38							9,41	10,22	9,41					9,41			9,41
12,700	4,76	1,20	5,16	0,60	3,00	0,15	0,55							9,41	10,22	9,41		10,22			9,41			9,41

	1	2	3	4	5	7	8	9	10	11	12	13	14	20	21	22	23	24	25						
12,700	4,76	0,40	5,16	0,40	2,50	0,10	0,35	10,22	8,87	10,22	8,87	10,22													

Die neuen Qualitäten SW33... sind erst vollständig verfügbar wenn die Auslaufmodelle SW22... nicht mehr lagerhaltig sind.  
*The new Grades SW33... are only fully available when the discontinued models SW22... are no longer in stock.*



WNMG

▲ empfohlene Qualität (auf Lager) **●** alternative Qualität (auf Lager) ■ Auslaufmodell (auf Lager bis ausverkauft)  
*recommended grade (on stock) alternative grade (on stock) discontinued model (in stock until sold out)*

Bestellcode Ordering Code	Qualität   Grades																									
	P							M								K	N	S								
	SW33105	SW22115	SW33115	SW22125	SW33125	SW22740	SW33740	SW12910	SW44115	SW12920	SW22120	SW44125	SW11425	SW22135	SW44740	SW11440	SW22705	SW22320	SW00910	SW12910	SW22410	SW11415	SW11515	SW12920	SW11420	
1	2	3	4	5	6	7	8	9	10	11	12	13	14	15	16	17	18	19	20	21	22	23	24	25		
WNMG 06T304-MR	■	●	■	▲																						
WNMG 06T308-MR	■	●	■	▲																						
WNMG 06T312-MR	■	●	■	▲																						
WNMG 060404-MR	■	●	■	▲																						
WNMG 060408-MR	■	●	■	▲																						
WNMG 060412-MR	■	●	■	▲																						
WNMG 080404-MR	■	●	■	▲	●	■																				
WNMG 080408-MR	■	●	■	▲	●	■																				
WNMG 080412-MR	■	●	■	▲	●	■																				
WNMG 080416-MR	■	●	■	▲	●	■																				

WNMG-MR



Mittlere Bearbeitung  
Medium

WNMG-SMR



Mittlere Bearbeitung  
Medium

	1	2	3	4	5	6	7	8	9	10	11	12	13	14	15	16	17	18	19	20	21	22	23	24	25	
WNMG 080408-SMR													▲	▲		▲										
WNMG 080412-SMR													▲	▲		▲										

WNMG-SSM



Mittlere Bearbeitung  
Medium

	1	2	3	4	5	6	7	8	9	10	11	12	13	14	15	16	17	18	19	20	21	22	23	24	25	
WNMG 060408-SSM														▲												
WNMG 080408-SSM														▲												
WNMG 080412-SSM														▲												
WNMG 080416-SSM														▲												

WNMG

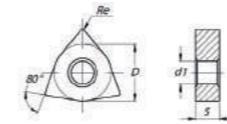

Maße Dimensions (mm)		Schnittdaten Cutting Details				Preis in €   Price in €																				
D	S	Re	d1	ap min	ap max	fn min	fn max	SW33105	SW22115	SW33115	SW22125	SW33125	SW22740	SW33740	SW12910	SW44115	SW12920	SW22120	SW44125	SW11425	SW22135	SW44740	SW11440	SW11515	SW12920	SW11420
								1	2	3	4	5	6	7	8	9	10	11	12	13	14	15	16	23	24	25
9,525	3,97	0,40	3,81	0,50	3,00	0,10	0,30		7,19	8,28	7,19	8,28														
9,525	3,97	0,80	3,81	0,50	3,00	0,15	0,50		7,19	8,28	7,19	8,28														
9,525	3,97	1,20	3,81	0,80	3,00	0,18	0,60		7,19	8,28	7,19	8,28														
9,525	4,76	0,40	3,81	0,50	3,00	0,10	0,30		7,19	8,28	7,19	8,28														
9,525	4,76	0,80	3,81	0,50	3,00	0,15	0,50		7,19	8,28	7,19	8,28														
9,525	4,76	1,20	3,81	0,80	3,00	0,18	0,60		7,19	8,28	7,19	8,28														
12,700	4,76	0,40	5,16	0,50	4,00	0,10	0,30		8,87	10,22	8,87	10,22	8,87	10,22												
12,700	4,76	0,80	5,16	0,50	4,00	0,15	0,50		8,87	10,22	8,87	10,22	8,87	10,22												
12,700	4,76	1,20	5,16	0,80	4,00	0,18	0,60		8,87	10,22	8,87	10,22	8,87	10,22												
12,700	4,76	1,60	5,16	1,00	4,00	0,23	0,65		8,87	10,22	8,87	10,22	8,87	10,22												

	1	2	3	4	5	6	7	8	9	10	11	12	13	14	15	16	23	24	25							
12,700	4,76	0,80	5,16	1,20	7,50	0,32	0,80																			
12,700	4,76	1,20	5,16	1,20	7,50	0,32	0,80																			

	1	2	3	4	5	6	7	8	9	10	11	12	13	14	15	16	23	24	25							
9,525	4,76	0,80	3,81	1,20	6,00	0,15	0,40																			
12,700	4,76	0,80	5,16	1,20	6,00	0,15	0,40																			
12,700	4,76	1,20	5,16	1,20	6,00	0,15	0,40																			
12,700	4,76	1,60	5,16	1,20	6,00	0,15	0,40																			



Ersetzt alte Qualität in neue Qualität. SW22115 wird durch SW33115 ersetzt. SW22125 wird durch SW33125 ersetzt. SW22740 wird durch SW33740 ersetzt.  
*Replaces old grade into new grade. SW22115 is replaced by SW33115. SW22125 is replaced by SW33125. SW22740 is replaced by SW33740.*

Wettbewerbs-Qualitätsvergleich siehe Seite 150-152. *Competitor grade comparison see pages 150-152.* →  
 Wettbewerbs-Spanbrechervergleich siehe Seite 154-157. *Competitor chipbreaker comparison see pages 154-157.* →

Die neuen Qualitäten SW33... sind erst vollständig verfügbar wenn die Auslaufmodelle SW22... nicht mehr lagerhaltig sind.  
*The new Grades SW33... are only fully available when the discontinued models SW22... are no longer in stock.*

WNMG

▲ empfohlene Qualität (auf Lager) **●** alternative Qualität (auf Lager) ■ Auslaufmodell (auf Lager bis ausverkauft)  
*recommended grade (on stock) alternative grade (on stock) discontinued model (in stock until sold out)*

Bestellcode Ordering Code	Qualität   Grades																								
	P							M								K	N	S							
	SW33105	SW22115	SW33115	SW22125	SW33125	SW22740	SW33740	SW12910	SW44115	SW12920	SW22120	SW44125	SW11425	SW22135	SW44740	SW11440	SW22705	SW22320	SW00910	SW12910	SW22410	SW11415	SW11515	SW12920	SW11420

WNMG-ST



Mittlere Bearbeitung  
Medium

	1	2	3	4	5	6	7	8	9	10	11	12	13	14	15	16	17	18	19	20	21	22	23	24	25
WNMG 080404-ST																	●	▲							
WNMG 080408-ST																	●	▲							
WNMG 080412-ST																	●	▲							
WNMG 080416-ST																	●	▲							

WNMG-MW

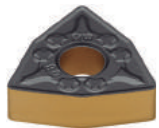

Mittlere Bearbeitung  
Wiper  
Medium Wiper

	1	2	3	4	5	6	7	8	9	10	11	12	13	14	15	16	17	18	19	20	21	22	23	24	25
WNMG 060408-MW	■	▲	■	●	■	●											■	▲							
WNMG 060412-MW	■	▲	■	●	■	●											■	▲							
WNMG 080408-MW	■	▲	■	●	■	●											■	▲							
WNMG 080412-MW	■	▲	■	●	■	●											■	▲							

WNMG-SS

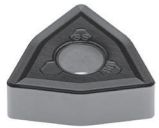

Schruppen bis  
Mittlere Bearbeitung  
Roughing to Medium

	1	2	3	4	5	6	7	8	9	10	11	12	13	14	15	16	17	18	19	20	21	22	23	24	25
WNMG 06T304-SS										▲															
WNMG 06T308-SS										▲															
WNMG 060404-SS								●	●	●		▲								●				▲	
WNMG 060408-SS								●	●	●		▲								●				▲	
WNMG 080404-SS								●	●	●		▲								●				▲	
WNMG 080408-SS								●	●	●		▲								●				▲	
WNMG 080412-SS								●	●	●		▲								●				▲	

WNMG-HR

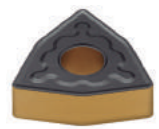

Schruppen  
Roughing

	1	2	3	4	5	6	7	8	9	10	11	12	13	14	15	16	17	18	19	20	21	22	23	24	25
WNMG 080408-HR	●	■	▲	■	●	■	●										●	▲							
WNMG 080412-HR	●	■	▲	■	●	■	●										●	▲							



Ersetzt alte Qualität in neue Qualität. SW22115 wird durch SW33115 ersetzt. SW22125 wird durch SW33125 ersetzt. SW22740 wird durch SW33740 ersetzt.  
*Replaces old grade into new grade. SW22115 is replaced by SW33115. SW22125 is replaced by SW33125. SW22740 is replaced by SW33740.*

Wettbewerbs-Qualitätsvergleich siehe Seite 150-152. *Competitor grade comparison see pages 150-152.* →

Wettbewerbs-Spanbrechervergleich siehe Seite 154-157. *Competitor chipbreaker comparison see pages 154-157.* →

WNMG

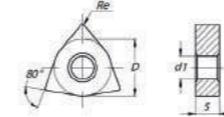

Maße Dimensions (mm)		Schnittdaten Cutting Details				Preis in €   Price in €																				
D	S	Re	d1	ap min	ap max	fn min	fn max	SW33105	SW22115	SW33115	SW22125	SW33125	SW22740	SW33740	SW12910	SW44115	SW12920	SW22120	SW44125	SW22705	SW22320	SW00910	SW12910	SW22410	SW12920	SW11420
								1	2	3	4	5	6	7	8	9	10	11	12	17	18	19	20	21	24	25
12,700	4,76	0,40	5,16	0,20	5,00	0,15	0,30													8,87	8,87					
12,700	4,76	0,80	5,16	0,20	5,00	0,15	0,50													8,87	8,87					
12,700	4,76	1,20	5,16	0,30	5,00	0,15	0,60													8,87	8,87					
12,700	4,76	1,60	5,16	0,30	5,00	0,20	0,70													8,87	8,87					

Maße Dimensions (mm)		Schnittdaten Cutting Details				Preis in €   Price in €																				
D	S	Re	d1	ap min	ap max	fn min	fn max	SW33105	SW22115	SW33115	SW22125	SW33125	SW22740	SW33740	SW12910	SW44115	SW12920	SW22120	SW44125	SW22705	SW22320	SW00910	SW12910	SW22410	SW12920	SW11420
								1	2	3	4	5	6	7	8	9	10	11	12	17	18	19	20	21	24	25
9,525	4,76	0,80	3,81	0,50	3,50	0,15	0,60		7,73	8,92	7,73	8,92	7,73	8,92						7,73	7,73					
9,525	4,76	1,20	3,81	0,80	3,50	0,20	0,90		7,73	8,92	7,73	8,92	7,73	8,92						7,73						
12,700	4,76	0,80	5,16	0,50	5,00	0,15	0,60		9,41	10,87	9,41	10,87	9,41	10,87						9,41						
12,700	4,76	1,20	5,16	0,80	6,00	0,20	0,90		9,41	10,87	9,41	10,87	9,41	10,87						9,41	9,41					

Maße Dimensions (mm)		Schnittdaten Cutting Details				Preis in €   Price in €																				
D	S	Re	d1	ap min	ap max	fn min	fn max	SW33105	SW22115	SW33115	SW22125	SW33125	SW22740	SW33740	SW12910	SW44115	SW12920	SW22120	SW44125	SW22705	SW22320	SW00910	SW12910	SW22410	SW12920	SW11420
								1	2	3	4	5	6	7	8	9	10	11	12	17	18	19	20	21	24	25
9,525	3,97	0,40	3,81	0,50	3,00	0,12	0,30												7,73							
9,525	3,97	0,80	3,81	0,50	3,00	0,12	0,45												7,73							
9,525	4,76	0,40	3,81	0,50	3,00	0,12	0,30								7,73	8,28	7,73		8,28				7,73	7,73		
9,525	4,76	0,80	3,81	0,50	3,00	0,12	0,45								7,73	8,28	7,73		8,28				7,73	7,73		
12,700	4,76	0,40	5,16	0,50	3,00	0,12	0,30								9,41	10,22	9,41		10,22				9,41	9,41		
12,700	4,76	0,80	5,16	0,50	4,00	0,12	0,45								9,41	10,22	9,41		10,22				9,41	9,41		
12,700	4,76	1,20	5,16	0,50	4,00	0,15	0,60								9,41	10,22	9,41		10,22				9,41	9,41		

Maße Dimensions (mm)		Schnittdaten Cutting Details				Preis in €   Price in €																				
D	S	Re	d1	ap min	ap max	fn min	fn max	SW33105	SW22115	SW33115	SW22125	SW33125	SW22740	SW33740	SW12910	SW44115	SW12920	SW22120	SW44125	SW22705	SW22320	SW00910	SW12910	SW22410	SW12920	SW11420
								1	2	3	4	5	6	7	8	9	10	11	12	17	18	19	20	21	24	25
12,700	4,76	0,80	5,16	0,80	5,00	0,20	0,55		10,22	8,87	10,22	8,87	10,22	8,87	10,22					8,87	8,87					
12,700	4,76	1,20	5,16	1,50	5,00	0,25	0,70		10,22	8,87	10,22	8,87	10,22	8,87	10,22					8,87	8,87					

Die neuen Qualitäten SW33... sind erst vollständig verfügbar wenn die Auslaufmodelle SW22... nicht mehr lagerhaltig sind.  
*The new Grades SW33... are only fully available when the discontinued models SW22... are no longer in stock.*



CCGT

▲ empfohlene Qualität (auf Lager) recommended grade (on stock) ● alternative Qualität (auf Lager) alternative grade (on stock) ■ auf Lager bis ausverkauft Stock available until sold out

Bestellcode Ordering Code	Qualität   Grades																										
	P							M							K		N			S							
	SW33105	SW22115	SW33115	SW22125	SW33125	SW22740	SW33740	SW12910	SW44115	SW12920	SW22120	SW44125	SW11425	SW22135	SW44740	SW11440	SW22705	SW22320	SW11610	SW00610	SW00910	SW12910	SW22410	SW11415	SW11515	SW12920	SW11420

CCGT-FS



Schlichten bis Feinschlichten  
Finishing to Fine Finishing

	1	2	3	4	5	6	7	8	9	10	11	12	13	14	15	16	17	18	19	20	21	22	23	24	25	26	27
CCGT 060201-FS								▲	●													●				▲	
CCGT 060202-FS								▲	●														●			▲	
CCGT 060204-FS								▲	●														●			▲	
CCGT 09T301-FS								▲	●														●			▲	
CCGT 09T302-FS								▲	●														●			▲	
CCGT 09T304-FS								▲	●														●			▲	



CCGT-LN



Mittlere Bearbeitung bis Schlichten  
Medium to Finishing

	1	2	3	4	5	6	7	8	9	10	11	12	13	14	15	16	17	18	19	20	21	22	23	24	25	26	27
CCGT 060202-LN																						▲					
CCGT 060204-LN																						▲					
CCGT 09T302-LN																						▲					
CCGT 09T304-LN																						▲					
CCGT 09T308-LN																						▲					
CCGT 120402-LN																						▲					
CCGT 120404-LN																						▲					
CCGT 120408-LN																						▲					

CCGT-SAL



Mittlere Bearbeitung  
Medium

	1	2	3	4	5	6	7	8	9	10	11	12	13	14	15	16	17	18	19	20	21	22	23	24	25	26	27
CCGT 060202-SAL																					▲	▲					
CCGT 060204-SAL																					▲	▲					
CCGT 09T302-SAL																					▲	▲					
CCGT 09T304-SAL																					▲	▲					
CCGT 09T308-SAL																					▲	▲					
CCGT 120404-SAL																					▲	▲					
CCGT 120408-SAL																					▲	▲					



Ersetzt alte Qualität in neue Qualität. SW22115 wird durch SW33115 ersetzt. SW22125 wird durch SW33125 ersetzt. SW22740 wird durch SW33740 ersetzt.  
Replaces old grade into new grade. SW22115 replaces SW33115. SW22125 replaces SW33125. SW22740 replaces SW33740.

Wettbewerbs-Qualitätsvergleich siehe Seite 150-152. Competitor grade comparison see pages 150-152. →

Wettbewerbs-Spanbrechervergleich siehe Seite 154-157. Competitor chipbreaker comparison see pages 154-157. →

CCGT

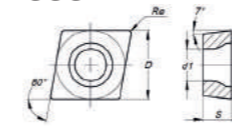

Maße Dimensions (mm)		Schnittdaten Cutting Details				Preis in €   Price in €																										
D	S	Re	d1	ap <sub>min</sub>	ap <sub>max</sub>	fn <sub>min</sub>	fn <sub>min</sub>	SW33105	SW22115	SW33115	SW22125	SW33125	SW22740	SW33740	SW12910	SW44115	SW12920	SW22705	SW22320	SW11610	SW00610	SW00910	SW12910	SW22410	SW11415	SW11515	SW12920	SW11420				
								1	2	3	4	5	6	7	8	9	10	17	18	19	20	21	22	23	24	25	26	27				
6,350	2,38	0,10	2,80	0,10	1,00	0,01	0,06									10,22	10,22						10,22				10,22					
6,350	2,38	0,20	2,80	0,10	1,50	0,02	0,12									10,22	10,22						10,22				10,22					
6,350	2,38	0,40	2,80	0,15	1,50	0,08	0,25									10,22	10,22						10,22				10,22					
9,525	3,97	0,10	4,40	0,10	1,50	0,01	0,06									11,09	11,09						11,09				11,09					
9,525	3,97	0,20	4,40	0,10	2,00	0,02	0,12									11,09	11,09						11,09				11,09					
9,525	3,97	0,40	4,40	0,15	2,50	0,08	0,25									11,09	11,09						11,09				11,09					

								1	2	3	4	5	6	7	8	9	10	17	18	19	20	21	22	23	24	25	26	27	
6,350	2,38	0,20	2,80	0,05	3,00	0,05	0,12																					10,57	
6,350	2,38	0,40	2,80	0,10	3,00	0,10	0,20																					10,57	
9,525	3,97	0,20	4,40	0,05	3,00	0,05	0,12																					11,47	
9,525	3,97	0,40	4,40	0,10	5,00	0,10	0,22																					11,47	
9,525	3,97	0,80	4,40	0,10	5,00	0,15	0,45																					11,47	
12,700	4,76	0,20	5,50	0,05	4,00	0,05	0,12																					13,15	
12,700	4,76	0,40	5,50	0,10	5,00	0,10	0,26																					13,15	
12,700	4,76	0,80	5,50	0,10	5,50	0,15	0,50																					13,15	

								1	2	3	4	5	6	7	8	9	10	17	18	19	20	21	22	23	24	25	26	27	
6,350	2,38	0,20	2,80	1,00	8,00	0,08	1,00																					10,69	8,68
6,350	2,38	0,40	2,80	1,00	8,00	0,08	1,00																					10,69	8,68
9,525	3,97	0,20	4,40	1,00	8,00	0,08	1,00																					11,29	9,22
9,525	3,97	0,40	4,40	1,00	8,00	0,08	1,00																					11,29	9,22
9,525	3,97	0,80	4,40	1,00	8,00	0,08	1,00																					11,29	9,22
12,700	4,76	0,40	5,50	1,00	8,00	0,08	1,00																					13,48	10,98
12,700	4,76	0,80	5,50	1,00	8,00	0,08	1,00																					13,48	10,98

Die neuen Qualitäten SW33... sind erst vollständig verfügbar wenn die Auslaufmodelle SW22... nicht mehr lagerhaltig sind.  
Die new Grades SW33... are only fully available when the discontinued models SW22... are no longer in stock

CCMT

▲ empfohlene Qualität (auf Lager) **●** alternative Qualität (auf Lager) ■ auf Lager bis ausverkauft  
 recommended grade (on stock) alternative grade (on stock) Stock available until sold out

Bestellcode Ordering Code	Qualität   Grades																										
	P							M							K	N			S								
	SW33105	SW22115	SW33115	SW22125	SW33125	SW22740	SW33740	SW12910	SW44115	SW12920	SW22120	SW44125	SW11425	SW22135	SW44740	SW11440	SW22705	SW22320	SW11610	SW00610	SW00910	SW12910	SW22410	SW11415	SW11515	SW12920	SW11420

CCMT-FP



Schichten  
Finishing

	1	2	3	4	5	6	7	8	9	10	11	12	13	14	15	16	17	18	19	20	21	22	23	24	25	26	27
CCMT 060202-FP				▲	▲																						
CCMT 060204-FP	▲	▲	▲	▲	▲																						
CCMT 09T302-FP				▲	▲																						
CCMT 09T304-FP	▲	▲	▲	▲	▲																						
CCMT 09T308-FP	▲	▲	▲	▲	▲																						
CCMT 120404-FP	▲	▲	▲	▲	▲																						



CCMT-BO



Schichten  
Finishing

	1	2	3	4	5	6	7	8	9	10	11	12	13	14	15	16	17	18	19	20	21	22	23	24	25	26	27
CCMT 060202-BO								●		▲												●				▲	
CCMT 060204-BO								●		▲												●				▲	
CCMT 060208-BO								●		▲												●				▲	
CCMT 09T304-BO								●		▲												●				▲	
CCMT 09T308-BO								●		▲												●				▲	
CCMT 120404-BO								●		▲												●				▲	
CCMT 120408-BO								●		▲												●				▲	

CCMT-FM



Schichten  
Finishing

	1	2	3	4	5	6	7	8	9	10	11	12	13	14	15	16	17	18	19	20	21	22	23	24	25	26	27
CCMT 060202-FM										▲																▲	
CCMT 060204-FM								●		▲		▲										●				▲	
CCMT 09T302-FM										▲																▲	
CCMT 09T304-FM								●		▲		▲										●				▲	
CCMT 09T308-FM								●		▲		▲										●				▲	
CCMT 120404-FM								●		▲		▲										●				▲	

CCMT-FK



Schichten  
Finishing

	1	2	3	4	5	6	7	8	9	10	11	12	13	14	15	16	17	18	19	20	21	22	23	24	25	26	27
CCMT 060202-FK																	▲										
CCMT 060204-FK																	▲										
CCMT 09T302-FK																	▲										
CCMT 09T304-FK																	▲										
CCMT 120404-FK																	▲										



Ersetzt alte Qualität in neue Qualität. SW22115 wird durch SW33115 ersetzt. SW22125 wird durch SW33125 ersetzt. SW22740 wird durch SW33740 ersetzt.  
 Replaces old grade into new grade. SW22115 replaces SW33115. SW22125 replaces SW33125. SW22740 replaces SW33740.

Wettbewerbs-Qualitätsvergleich siehe Seite 150-152. Competitor grade comparison see pages 150-152. →

Wettbewerbs-Spanbrechervergleich siehe Seite 154-157. Competitor chipbreaker comparison see pages 154-157. →

CCMT

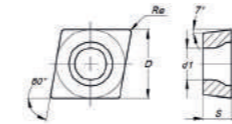

Maße Dimensions (mm)		Schnittdaten Cutting Details				Preis in €   Price in €																										
D	S	Re	d1	ap min	ap max	fn min	fn max	SW33105	SW22115	SW33115	SW22125	SW33125	SW22740	SW33740	SW12910	SW44115	SW12920	SW22120	SW44125	SW11440	SW22705	SW00910	SW12910	SW22410	SW11415	SW11515	SW12920	SW11420				
								1	2	3	4	5	6	7	8	9	10	11	12	16	17	21	22	23	24	25	26	27				
6,350	2,38	0,20	2,80	0,06	1,70	0,03	0,11					6,92	8,00																			
6,350	2,38	0,40	2,80	0,10	1,70	0,05	0,17		6,92	8,00	6,92	8,00																				
9,525	3,97	0,20	4,40	0,08	2,00	0,04	0,13					6,92	8,00																			
9,525	3,97	0,40	4,40	0,11	2,00	0,06	0,23		6,92	8,00	6,92	8,00																				
9,525	3,97	0,80	4,40	0,15	2,00	0,08	0,45		6,92	8,00	6,92	8,00																				
12,700	4,76	0,40	5,50	0,14	2,40	0,07	0,27		8,60	9,95	8,60	9,95																				

								1	2	3	4	5	6	7	8	9	10	11	12	16	17	21	22	23	24	25	26	27
6,350	2,38	0,20	2,80	0,30	1,00	0,05	0,13									7,73		7,73						7,73			7,73	
6,350	2,38	0,40	2,80	0,30	1,00	0,08	0,20									7,73		7,73						7,73			7,73	
6,350	2,38	0,80	2,80	0,30	1,00	0,10	0,30									7,73											7,73	
9,525	3,97	0,40	4,40	0,50	1,20	0,08	0,20									8,28		8,28						8,28			8,28	
9,525	3,97	0,80	4,40	0,50	1,20	0,10	0,30									8,28		8,28						8,28			8,28	
12,700	4,76	0,40	5,50	0,50	1,50	0,08	0,20									9,68		9,68						9,68			9,68	
12,700	4,76	0,80	5,50	0,50	1,50	0,10	0,30									9,68		9,68						9,68			9,68	

								1	2	3	4	5	6	7	8	9	10	11	12	16	17	21	22	23	24	25	26	27
6,350	2,38	0,20	2,80	0,06	1,70	0,03	0,11												6,92								6,92	
6,350	2,38	0,40	2,80	0,10	1,70	0,05	0,17											6,92	6,92	8,00			6,92			6,92		
9,525	3,97	0,20	4,40	0,08	2,00	0,04	0,13											6,92								6,92		
9,525	3,97	0,40	4,40	0,11	2,00	0,06	0,23										6,92	6,92	8,00			6,92			6,92			
9,525	3,97	0,80	4,40	0,15	2,00	0,08	0,45										6,92	6,92	8,00			6,92			6,92			
12,700	4,76	0,40	5,50	0,14	2,40	0,07	0,27										8,60	8,60	9,95						8,60			

								1	2	3	4	5	6	7	8	9	10	11	12	16	17	21	22	23	24	25	26	27
6,350	2,38	0,20	2,80	0,06	1,70	0,03	0,11																				6,92	
6,350	2,38	0,40	2,80	0,10	1,70	0,05	0,17																				6,92	
9,525	3,97	0,20	4,40	0,08	2,00	0,04	0,13																				6,92	
9,525	3,97	0,40	4,40	0,11	2,00	0,06	0,23																				6,92	
12,700	4,76	0,40	5,50	0,14	2,40	0,07	0,27																				8,60	

Die neuen Qualitäten SW33... sind erst vollständig verfügbar wenn die Auslaufmodelle SW22... nicht mehr lagerhaltig sind.  
 Die new Grades SW33... are only fully available when the discontinued models SW22... are no longer in stock

CCMT

▲ empfohlene Qualität (auf Lager) recommended grade (on stock) ● alternative Qualität (auf Lager) alternative grade (on stock) ■ auf Lager bis ausverkauft Stock available until sold out

Bestellcode Ordering Code	Qualität   Grades																										
	P							M							K		N			S							
	SW33105	SW22115	SW33115	SW22125	SW33125	SW22740	SW33740	SW12910	SW44115	SW12920	SW22120	SW44125	SW11425	SW22135	SW44740	SW11440	SW22705	SW22320	SW11610	SW00610	SW00910	SW12910	SW22410	SW11415	SW11515	SW12920	SW11420

CCMT-FW



Schlichten Wiper  
Finishing Wiper

	1	2	3	4	5	6	7	8	9	10	11	12	13	14	15	16	17	18	19	20	21	22	23	24	25	26	27
CCMT 060204-FW										▲								▲									▲
CCMT 060208-FW										▲								▲									▲
CCMT 09T304-FW										▲								▲									▲
CCMT 09T308-FW										▲								▲									▲



CCMT-LM



Mittlere Bearbeitung bis Schlichten  
Medium to Finishing

	1	2	3	4	5	6	7	8	9	10	11	12	13	14	15	16	17	18	19	20	21	22	23	24	25	26	27
CCMT 060204-LM										▲	●											●					▲
CCMT 09T304-LM										▲	●											●					▲
CCMT 120404-LM										▲	●											●					▲

CCMT-MP



Mittlere Bearbeitung  
Medium

	1	2	3	4	5	6	7	8	9	10	11	12	13	14	15	16	17	18	19	20	21	22	23	24	25	26	27
CCMT 060204-MP			●	●	▲																						
CCMT 060208-MP			●	●	▲																						
CCMT 09T304-MP			●	●	▲																						
CCMT 09T308-MP			●	●	▲																						
CCMT 120404-MP			●	●	▲																						
CCMT 120408-MP			●	●	▲																						
CCMT 120412-MP			●	●	▲																						

CCMT-MM

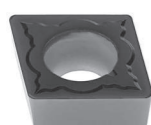

Mittlere Bearbeitung  
Medium

	1	2	3	4	5	6	7	8	9	10	11	12	13	14	15	16	17	18	19	20	21	22	23	24	25	26	27
CCMT 060204-MM										●	▲	●										●					▲
CCMT 060208-MM										▲	●																▲
CCMT 09T304-MM										●	▲	●										●					▲
CCMT 09T308-MM										●	▲	●										●					▲
CCMT 120404-MM										▲	●											●					▲
CCMT 120408-MM										●	▲	●										●					▲
CCMT 120412-MM										●	▲	●										●					▲



Ersetzt alte Qualität in neue Qualität. SW22115 wird durch SW33115 ersetzt. SW22125 wird durch SW33125 ersetzt. SW22740 wird durch SW33740 ersetzt.  
Replaces old grade into new grade. SW22115 replaces SW33115. SW22125 replaces SW33125. SW22740 replaces SW33740.

Wettbewerbs-Qualitätsvergleich siehe Seite 150-152. Competitor grade comparison see pages 150-152. →  
Wettbewerbs-Spanbrechervergleich siehe Seite 154-157. Competitor chipbreaker comparison see pages 154-157. →

CCMT

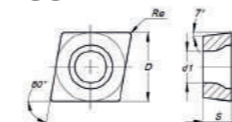

Maße Dimensions (mm)		Schnittdaten Cutting Details				Preis in €   Price in €																										
D	S	Re	d1	ap min	ap max	fn min	fn max	SW33105	SW22115	SW33115	SW22125	SW33125	SW22740	SW33740	SW12910	SW44115	SW12920	SW22705	SW22320	SW11610	SW00610	SW00910	SW12910	SW22410	SW11415	SW11515	SW12920	SW11420				
6,350	2,38	0,40	2,80	0,30	2,00	0,05	0,30	7,46	8,60								7,46	7,46										7,46				
6,350	2,38	0,80	2,80	0,30	2,00	0,09	0,35	7,46	8,60								7,46	7,46										7,46				
9,525	3,97	0,40	4,40	0,30	3,00	0,07	0,30	7,73	8,92								7,73	7,73										7,73				
9,525	3,97	0,80	4,40	0,30	3,00	0,12	0,50	7,73	8,92								7,73	7,73										7,73				

Maße Dimensions (mm)		Schnittdaten Cutting Details				Preis in €   Price in €																										
D	S	Re	d1	ap min	ap max	fn min	fn max	SW33105	SW22115	SW33115	SW22125	SW33125	SW22740	SW33740	SW12910	SW44115	SW12920	SW22705	SW22320	SW11610	SW00610	SW00910	SW12910	SW22410	SW11415	SW11515	SW12920	SW11420				
6,350	2,38	0,40	2,80	0,20	2,00	0,08	0,20										6,92	6,92										6,92				
9,525	3,97	0,40	4,40	0,25	2,50	0,10	0,30										6,92	6,92										6,92				
12,700	4,76	0,40	5,50	0,30	3,00	0,12	0,35										8,60	8,60										8,60				

Maße Dimensions (mm)		Schnittdaten Cutting Details				Preis in €   Price in €																										
D	S	Re	d1	ap min	ap max	fn min	fn max	SW33105	SW22115	SW33115	SW22125	SW33125	SW22740	SW33740	SW12910	SW44115	SW12920	SW22705	SW22320	SW11610	SW00610	SW00910	SW12910	SW22410	SW11415	SW11515	SW12920	SW11420				
6,350	2,38	0,40	2,80	0,20	2,40	0,06	0,17	6,92	8,00	6,92	8,00																					
6,350	2,38	0,80	2,80	0,40	2,40	0,08	0,35	6,92	8,00	6,92	8,00																					
9,525	3,97	0,40	4,40	0,25	3,00	0,08	0,23	6,92	8,00	6,92	8,00																					
9,525	3,97	0,80	4,40	0,50	3,00	0,10	0,40	6,92	8,00	6,92	8,00																					
12,700	4,76	0,40	5,50	0,30	3,60	0,09	0,27	8,60	9,95	8,60	9,95																					
12,700	4,76	0,80	5,50	0,60	3,60	0,12	0,45	8,60	9,95	8,60	9,95																					
12,700	4,76	1,20	5,50	0,72	3,60	0,14	0,60	8,60	9,95	8,60	9,95																					

Maße Dimensions (mm)		Schnittdaten Cutting Details				Preis in €   Price in €																										
D	S	Re	d1	ap min	ap max	fn min	fn max	SW33105	SW22115	SW33115	SW22125	SW33125	SW22740	SW33740	SW12910	SW44115	SW12920	SW22705	SW22320	SW11610	SW00610	SW00910	SW12910	SW22410	SW11415	SW11515	SW12920	SW11420				
6,350	2,38	0,40	2,80	0,20	2,40	0,06	0,17										6,92	8,00	6,92									6,92				
6,350	2,38	0,80	2,80	0,40	2,40	0,08	0,35										8,00	6,92										6,92				
9,525	3,97	0,40	4,40	0,25	3,00	0,08	0,23										6,92	8,00	6,92									6,92				
9,525	3,97	0,80	4,40	0,50	3,00	0,10	0,40										6,92	8,00	6,92									6,92				
12,700	4,76	0,40	5,50	0,30	3,60	0,09	0,27										9,95	8,60										8,60				
12,700	4,76	0,80	5,50	0,60	3,60	0,12	0,45										8,60	9,95	8,60									8,60				
12,700	4,76	1,20	5,50	0,72	3,60	0,14	0,60										8,60	9,95	8,60									8,60				

Die neuen Qualitäten SW33... sind erst vollständig verfügbar wenn die Auslaufmodelle SW22... nicht mehr lagerhaltig sind.  
Die new Grades SW33... are only fully available when the discontinued models SW22... are no longer in stock

CCMT

▲ empfohlene Qualität (auf Lager) ● alternative Qualität (auf Lager) ■ auf Lager bis ausverkauft  
 recommended grade (on stock) alternative grade (on stock) Stock available until sold out

Bestellcode Ordering Code	Qualität   Grades																										
	P						M							K		N			S								
	SW33105	SW22115	SW33115	SW22125	SW33125	SW22740	SW33740	SW12910	SW44115	SW12920	SW22120	SW44125	SW11425	SW22135	SW44740	SW11440	SW22705	SW22320	SW11610	SW00610	SW00910	SW12910	SW22410	SW11415	SW11515	SW12920	SW11420

CCMT-MMX



Mittlere Bearbeitung  
Medium

	1	2	3	4	5	6	7	8	9	10	11	12	13	14	15	16	17	18	19	20	21	22	23	24	25	26	27
CCMT 060202-MMX											▲		▲	▲													
CCMT 060204-MMX											▲		▲	▲													
CCMT 09T304-MMX											▲		▲														
CCMT 09T308-MMX											▲		▲														
CCMT 120404-MMX													▲														
CCMT 120408-MMX													▲														

CCMT-SMS



Mittlere Bearbeitung  
Medium

	1	2	3	4	5	6	7	8	9	10	11	12	13	14	15	16	17	18	19	20	21	22	23	24	25	26	27
CCMT 09T304-SMS														▲													
CCMT 09T308-SMS														▲													
CCMT 120404-SMS														▲													
CCMT 120408-SMS														▲													

CCMT-MTS



Mittlere Bearbeitung  
Medium

	1	2	3	4	5	6	7	8	9	10	11	12	13	14	15	16	17	18	19	20	21	22	23	24	25	26	27
CCMT 09T304-MTS																							▲				▲

CCMT-MK

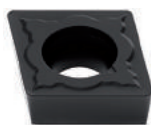

Mittlere Bearbeitung  
Medium

	1	2	3	4	5	6	7	8	9	10	11	12	13	14	15	16	17	18	19	20	21	22	23	24	25	26	27
CCMT 060204-MK																		●	▲								
CCMT 060208-MK																		●	▲								
CCMT 09T304-MK																		●	▲								
CCMT 09T308-MK																		●	▲								
CCMT 120404-MK																		●	▲								
CCMT 120408-MK																		●	▲								

CCMT-MW

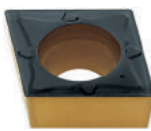

Mittlere Bearbeitung bis Schlichten Wiper  
Medium to Finishing Wiper

	1	2	3	4	5	6	7	8	9	10	11	12	13	14	15	16	17	18	19	20	21	22	23	24	25	26	27
CCMT 060208-MW		▲	▲							▲								▲								▲	
CCMT 09T304-MW		▲	▲							▲								▲								▲	
CCMT 09T308-MW		▲	▲							▲								▲								▲	
CCMT 120404-MW		▲	▲							▲								▲								▲	
CCMT 120408-MW		▲	▲							▲								▲								▲	



Ersetzt alte Qualität in neue Qualität. SW22115 wird durch SW33115 ersetzt. SW22125 wird durch SW33125 ersetzt. SW22740 wird durch SW33740 ersetzt.  
 Replaces old grade into new grade. SW22115 is replaced by SW33115. SW22125 is replaced by SW33125. SW22740 is replaced by SW33740.

CCMT

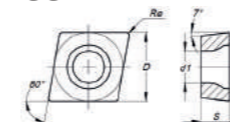

Maße Dimensions (mm)			Schnittdaten Cutting Details				Preis in €   Price in €																										
D	S	Re	d1	ap <sub>min</sub>	ap <sub>max</sub>	fn <sub>min</sub>	fn <sub>max</sub>	SW33105	SW22115	SW33115	SW12920	SW22120	SW44125	SW11425	SW22135	SW44740	SW11440	SW22705	SW22320	SW11610	SW00610	SW00910	SW12910	SW22410	SW11515	SW12920	SW11420						
								1	2	3	10	11	12	13	14	15	16	17	18	19	20	21	22	23	25	26	27						
6,350	2,38	0,20	2,80	1,00	3,80	0,17	0,45					5,21		5,21	4,96																		
6,350	2,38	0,40	2,80	1,00	3,80	0,17	0,45					5,21		5,21	4,96																		
9,525	3,97	0,40	4,40	1,00	3,80	0,17	0,45					6,01		6,01																			
9,525	3,97	0,80	4,40	1,00	3,80	0,17	0,45					6,01		6,01																			
12,700	4,76	0,40	5,50	1,00	3,80	0,17	0,45							10,24																			
12,700	4,76	0,80	5,50	1,00	3,80	0,17	0,45							10,24																			

	1	2	3	10	11	12	13	14	15	16	17	18	19	20	21	22	23	25	26	27							
9,525	3,97	0,40	4,40	0,45	9,50	0,13	0,60							5,76													
9,525	3,97	0,80	4,40	0,45	9,50	0,13	0,60							5,76													
12,700	4,76	0,40	5,50	0,45	9,50	0,13	0,60							9,82													
12,700	4,76	0,80	5,50	0,45	9,50	0,13	0,60							9,82													

	1	2	3	10	11	12	13	14	15	16	17	18	19	20	21	22	23	25	26	27							
9,525	3,97	0,40	4,40	1,00	5,00	0,20	0,45																	6,01			6,01

	1	2	3	10	11	12	13	14	15	16	17	18	19	20	21	22	23	25	26	27								
6,350	2,38	0,40	2,80	0,20	2,40	0,06	0,17																			5,59	5,59	
6,350	2,38	0,80	2,80	0,40	2,40	0,08	0,35																				5,59	5,59
9,525	3,97	0,40	4,40	0,25	3,00	0,08	0,23																				6,94	6,94
9,525	3,97	0,80	4,40	0,50	3,00	0,10	0,40																				6,94	6,94
12,700	4,76	0,40	5,50	0,30	3,60	0,09	0,27																				8,61	8,61
12,700	4,76	0,80	5,50	0,60	3,60	0,12	0,45																				8,61	8,61

	1	2	3	10	11	12	13	14	15	16	17	18	19	20	21	22	23	25	26	27							
6,350	2,38	0,80	2,80	0,50	2,50	0,10	0,40		7,46	8,62	7,46																7,46
9,525	3,97	0,40	4,40	0,50	4,00	0,12	0,40		7,72	8,91	7,72																7,72
9,525	3,97	0,80	4,40	0,70	4,00	0,15	0,50		7,72	8,91	7,72																7,72
12,700	4,76	0,40	5,50	0,50	4,00	0,15	0,40		9,14	10,56	9,14																9,14
12,700	4,76	0,80	5,50	0,70	4,00	0,15	0,50		9,14	10,56	9,14																9,14

Wettbewerbs-Qualitätsvergleich siehe Seite 150-152. Competitor grade comparison see pages 150-152. →

Wettbewerbs-Spanbrechervergleich siehe Seite 154-157. Competitor chipbreaker comparison see pages 154-157. →

Die neuen Qualitäten SW33... sind erst vollständig verfügbar wenn die Auslaufmodelle SW22... nicht mehr lagerhaltig sind.  
 The new Grades SW33... are only fully available when the discontinued models SW22... are no longer in stock





DCMT

▲ empfohlene Qualität (auf Lager) **●** alternative Qualität (auf Lager) ■ auf Lager bis ausverkauft  
*recommended grade (on stock) alternative grade (on stock) Stock available until sold out*

Bestellcode Ordering Code	Qualität   Grades																										
	P							M							K		N			S							
	SW33105	SW22115	SW33115	SW22125	SW33125	SW22740	SW33740	SW12910	SW44115	SW12920	SW22120	SW44125	SW11425	SW22135	SW44740	SW11440	SW22705	SW22320	SW11610	SW00610	SW00910	SW12910	SW22410	SW11415	SW11515	SW12920	SW11420

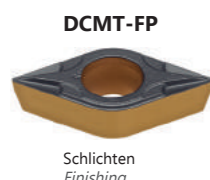

	1	2	3	4	5	6	7	8	9	10	11	12	13	14	15	16	17	18	19	20	21	22	23	24	25	26	27
DCMT 070202-FP				▲	▲																						
DCMT 070204-FP	■	▲	■	●																							
DCMT 11T302-FP				▲	▲																						
DCMT 11T304-FP	■	▲	■	●																							
DCMT 11T308-FP	■	▲	■	●																							



	1	2	3	4	5	6	7	8	9	10	11	12	13	14	15	16	17	18	19	20	21	22	23	24	25	26	27
DCMT 070202-FM										▲																▲	
DCMT 070204-FM										●	▲															▲	
DCMT 11T302-FM								●		▲												●				▲	
DCMT 11T304-FM								●		▲												●				▲	
DCMT 11T308-FM								●		▲												●				▲	



	1	2	3	4	5	6	7	8	9	10	11	12	13	14	15	16	17	18	19	20	21	22	23	24	25	26	27
DCMT 070202-FK																		▲									
DCMT 070204-FK																		▲									
DCMT 11T302-FK																		▲									
DCMT 11T304-FK																		▲									

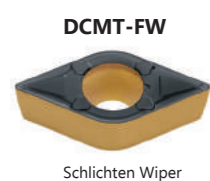

	1	2	3	4	5	6	7	8	9	10	11	12	13	14	15	16	17	18	19	20	21	22	23	24	25	26	27
DCMT 070204-FW		■	▲							▲								▲									▲
DCMT 070208-FW		■	▲							▲								▲									▲
DCMT 11T304-FW		■	▲							▲								▲									▲
DCMT 11T308-FW		■	▲							▲								▲									▲

Ersetzt alte Qualität in neue Qualität. SW22115 wird durch SW33115 ersetzt. SW22125 wird durch SW33125 ersetzt. SW22740 wird durch SW33740 ersetzt.  
*Replaces old grade into new grade. SW22115 replaces SW33115. SW22125 replaces SW33125. SW22740 replaces SW33740.*

Wettbewerbs-Qualitätsvergleich siehe Seite 150-152. [Competitor grade comparison see pages 150-152.](#)  
 Wettbewerbs-Spanbrechervergleich siehe Seite 154-157. [Competitor chipbreaker comparison see pages 154-157.](#)

DCMT

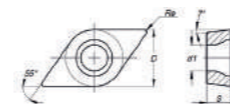

Maße Dimensions (mm)		Schnittdaten Cutting Details						Preis in €   Price in €																										
D	S	Re	d1	ap_min	ap_max	fn_min	fn_max	SW33105	SW22115	SW33115	SW22125	SW33125	SW22740	SW33740	SW12910	SW44115	SW12920	SW22120	SW44125	SW11425	SW22135	SW44740	SW11440	SW22705	SW22320	SW12910	SW12920	SW11420						
6,350	2,38	0,20	2,80	0,06	1,50	0,03	0,11					6,92	8,00																					
6,350	2,38	0,40	2,80	0,08	1,50	0,05	0,17		6,92	8,00	6,92	8,00																						
9,525	3,97	0,20	4,40	0,08	2,00	0,04	0,15					6,92	8,00																					
9,525	3,97	0,40	4,40	0,11	2,00	0,06	0,23		6,92	8,00	6,92	8,00																						
9,525	3,97	0,80	4,40	0,15	2,00	0,08	0,30		6,92	8,00	6,92	8,00																						

Maße Dimensions (mm)		Schnittdaten Cutting Details						Preis in €   Price in €																										
D	S	Re	d1	ap_min	ap_max	fn_min	fn_max	SW33105	SW22115	SW33115	SW22125	SW33125	SW22740	SW33740	SW12910	SW44115	SW12920	SW22120	SW44125	SW11425	SW22135	SW44740	SW11440	SW22705	SW22320	SW12910	SW12920	SW11420						
6,350	2,38	0,20	2,80	0,06	1,50	0,03	0,11																											
6,350	2,38	0,40	2,80	0,08	1,50	0,05	0,17												6,92									6,92						
9,525	3,97	0,20	4,40	0,08	2,00	0,04	0,15											6,92									6,92	6,92						
9,525	3,97	0,40	4,40	0,11	2,00	0,06	0,23											6,92									6,92	6,92						
9,525	3,97	0,80	4,40	0,15	2,00	0,08	0,30											6,92									6,92	6,92						

Maße Dimensions (mm)		Schnittdaten Cutting Details						Preis in €   Price in €																										
D	S	Re	d1	ap_min	ap_max	fn_min	fn_max	SW33105	SW22115	SW33115	SW22125	SW33125	SW22740	SW33740	SW12910	SW44115	SW12920	SW22120	SW44125	SW11425	SW22135	SW44740	SW11440	SW22705	SW22320	SW12910	SW12920	SW11420						
6,350	2,38	0,20	2,80	0,06	1,50	0,03	0,11																											
6,350	2,38	0,40	2,80	0,08	1,50	0,05	0,17																											
9,525	3,97	0,20	4,40	0,08	2,00	0,04	0,15																											
9,525	3,97	0,40	4,40	0,11	2,00	0,06	0,23																											

Maße Dimensions (mm)		Schnittdaten Cutting Details						Preis in €   Price in €																										
D	S	Re	d1	ap_min	ap_max	fn_min	fn_max	SW33105	SW22115	SW33115	SW22125	SW33125	SW22740	SW33740	SW12910	SW44115	SW12920	SW22120	SW44125	SW11425	SW22135	SW44740	SW11440	SW22705	SW22320	SW12910	SW12920	SW11420						
6,350	2,38	0,40	2,80	0,30	2,00	0,05	0,25			7,46	8,60																							
6,350	2,38	0,80	2,80	0,30	2,00	0,09	0,35			7,46	8,60																							
9,525	3,97	0,40	4,40	0,30	3,00	0,07	0,30			7,73	8,92																							
9,525	3,97	0,80	4,40	0,30	3,00	0,12	0,40			7,73	8,92																							

Die neuen Qualitäten SW33... sind erst vollständig verfügbar wenn die Auslaufmodelle SW22... nicht mehr lagerhaltig sind.  
*The new Grades SW33... are only fully available when the discontinued models SW22... are no longer in stock*

DCMT

▲ empfohlene Qualität (auf Lager) recommended grade (on stock) ● alternative Qualität (auf Lager) alternative grade (on stock) ■ auf Lager bis ausverkauft Stock available until sold out



DCMT-LM



Mittlere Bearbeitung bis Schlichten  
Medium to Finishing

Bestellcode Ordering Code	Qualität   Grades																										
	P							M									K		N			S					
	SW33105	SW22115	SW33115	SW22125	SW33125	SW22740	SW33740	SW12910	SW44115	SW12920	SW22120	SW44125	SW11425	SW22135	SW44740	SW11440	SW22705	SW22320	SW11610	SW00610	SW00910	SW12910	SW22410	SW11415	SW11515	SW12920	SW11420
DCMT 11T304-LM							▲	●														●				▲	
DCMT 11T308-LM							▲	●														●				▲	

DCMT-MP

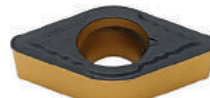

Mittlere Bearbeitung  
Medium

Bestellcode	1	2	3	4	5	6	7	8	9	10	11	12	13	14	15	16	17	18	19	20	21	22	23	24	25	26	27
DCMT 070204-MP		■	●	■	▲																						
DCMT 070208-MP		■	●	■	▲																						
DCMT 11T304-MP		■	●	■	▲																						
DCMT 11T308-MP		■	●	■	▲																						
DCMT 11T312-MP		■	●	■	▲																						

DCMT-MM



Mittlere Bearbeitung  
Medium

Bestellcode	1	2	3	4	5	6	7	8	9	10	11	12	13	14	15	16	17	18	19	20	21	22	23	24	25	26	27
DCMT 070204-MM								●	▲	●												●				▲	
DCMT 070208-MM								▲	●																		▲
DCMT 11T304-MM								●	▲	●												●				▲	
DCMT 11T308-MM								●	▲	●												●				▲	
DCMT 11T312-MM								●	▲	●																▲	

DCMT-MK



Mittlere Bearbeitung  
Medium

Bestellcode	1	2	3	4	5	6	7	8	9	10	11	12	13	14	15	16	17	18	19	20	21	22	23	24	25	26	27
DCMT 070204-MK																		●	▲								
DCMT 070208-MK																		●	▲								
DCMT 11T304-MK																		●	▲								
DCMT 11T308-MK																		●	▲								
DCMT 11T312-MK																		●	▲								

DCMT-MW



Mittlere Bearbeitung bis Schlichten Wiper  
Medium to Finishing Wiper

Bestellcode	1	2	3	4	5	6	7	8	9	10	11	12	13	14	15	16	17	18	19	20	21	22	23	24	25	26	27
DCMT 11T304-MW		■	▲							▲									▲								▲
DCMT 11T308-MW		■	▲							▲									▲								▲



Ersetzt alte Qualität in neue Qualität. SW22115 wird durch SW33115 ersetzt. SW22125 wird durch SW33125 ersetzt. SW22740 wird durch SW33740 ersetzt.  
Replaces old grade into new grade. SW22115 is replaced by SW33115. SW22125 is replaced by SW33125. SW22740 is replaced by SW33740.

DCMT

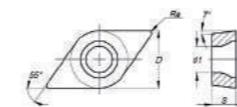

Maße Dimensions (mm)		Schnittdaten Cutting Details				Preis in €   Price in €																										
D	S	Re	d1	ap min	ap max	fn min	fn max	SW33105	SW22115	SW33115	SW22125	SW33125	SW12910	SW44115	SW12920	SW44740	SW11440	SW22705	SW22320	SW11610	SW00610	SW00910	SW12910	SW22410	SW11415	SW11515	SW12920	SW11420				
9,525	3,97	0,40	4,40	0,15	2,50	0,08	0,25							6,92	6,92									6,92				6,92				
9,525	3,97	0,80	4,40	0,20	2,50	0,10	0,35							6,92	6,92									6,92				6,92				

Maße Dimensions (mm)		Schnittdaten Cutting Details				Preis in €   Price in €																										
D	S	Re	d1	ap min	ap max	fn min	fn max	SW33105	SW22115	SW33115	SW22125	SW33125	SW12910	SW44115	SW12920	SW44740	SW11440	SW22705	SW22320	SW11610	SW00610	SW00910	SW12910	SW22410	SW11415	SW11515	SW12920	SW11420				
6,350	2,38	0,40	2,80	0,19	2,25	0,06	0,17		6,92	8,00	6,92	8,00																				
6,350	2,38	0,80	2,80	0,38	2,25	0,08	0,35		6,92	8,00	6,92	8,00																				
9,525	3,97	0,40	4,40	0,25	3,00	0,08	0,23		6,92	8,00	6,92	8,00																				
9,525	3,97	0,80	4,40	0,50	3,00	0,10	0,40		6,92	8,00	6,92	8,00																				
9,525	3,97	1,20	4,40	0,60	3,00	0,12	0,60		6,92	8,00	6,92	8,00																				

Maße Dimensions (mm)		Schnittdaten Cutting Details				Preis in €   Price in €																										
D	S	Re	d1	ap min	ap max	fn min	fn max	SW33105	SW22115	SW33115	SW22125	SW33125	SW12910	SW44115	SW12920	SW44740	SW11440	SW22705	SW22320	SW11610	SW00610	SW00910	SW12910	SW22410	SW11415	SW11515	SW12920	SW11420				
6,350	2,38	0,40	2,80	0,19	2,25	0,06	0,17						6,92	8,00	6,92									6,92				6,92				
6,350	2,38	0,80	2,80	0,38	2,25	0,08	0,35							8,00	6,92													6,92				
9,525	3,97	0,40	4,40	0,25	3,00	0,08	0,23							6,92	8,00	6,92								6,92				6,92				
9,525	3,97	0,80	4,40	0,50	3,00	0,10	0,40							6,92	8,00	6,92								6,92				6,92				
9,525	3,97	1,20	4,40	0,60	3,00	0,12	0,60							6,92	8,00	6,92												6,92				

Maße Dimensions (mm)		Schnittdaten Cutting Details				Preis in €   Price in €																										
D	S	Re	d1	ap min	ap max	fn min	fn max	SW33105	SW22115	SW33115	SW22125	SW33125	SW12910	SW44115	SW12920	SW44740	SW11440	SW22705	SW22320	SW11610	SW00610	SW00910	SW12910	SW22410	SW11415	SW11515	SW12920	SW11420				
6,350	2,38	0,40	2,80	0,19	2,25	0,06	0,17																					6,92	6,92			
6,350	2,38	0,80	2,80	0,38	2,25	0,08	0,35																					6,92	6,92			
9,525	3,97	0,40	4,40	0,25	3,00	0,08	0,23																					6,92	6,92			
9,525	3,97	0,80	4,40	0,50	3,00	0,10	0,40																					6,92	6,92			
9,525	3,97	1,20	4,40	0,50	3,00	0,12	0,60																					6,92	6,92			

Maße Dimensions (mm)		Schnittdaten Cutting Details				Preis in €   Price in €																										
D	S	Re	d1	ap min	ap max	fn min	fn max	SW33105	SW22115	SW33115	SW22125	SW33125	SW12910	SW44115	SW12920	SW44740	SW11440	SW22705	SW22320	SW11610	SW00610	SW00910	SW12910	SW22410	SW11415	SW11515	SW12920	SW11420				
9,525	3,97	0,40	4,40	0,50	4,00	0,12	0,40		7,73	8,92					7,73									7,73				7,73				
9,525	3,97	0,80	4,40	0,50	4,00	0,15	0,50		7,73	8,92					7,73									7,73				7,73				

Wettbewerbs-Qualitätsvergleich siehe Seite 150-152. Competitor grade comparison see pages 150-152. →

Wettbewerbs-Spanbrechervergleich siehe Seite 154-157. Competitor chipbreaker comparison see pages 154-157. →

Die neuen Qualitäten SW33... sind erst vollständig verfügbar wenn die Auslaufmodelle SW22... nicht mehr lagerhaltig sind.  
The new Grades SW33... are only fully available when the discontinued models SW22... are no longer in stock

RCGT

▲ empfohlene Qualität (auf Lager) **●** alternative Qualität (auf Lager) ■ auf Lager bis ausverkauft  
*recommended grade (on stock) alternative grade (on stock) Stock available until sold out*

Bestellcode Ordering Code	Qualität   Grades																										
	P						M						K	N			S										
	SW33105	SW22115	SW33115	SW22125	SW33125	SW22740	SW33740	SW12910	SW44115	SW12920	SW22120	SW44125	SW11425	SW22135	SW44740	SW11440	SW22705	SW22320	SW11610	SW00610	SW00910	SW12910	SW22410	SW11415	SW11515	SW12920	SW11420
RCGT 0602M0-SAL																		▲	▲								
RCGT 0803M0-SAL																		▲	▲								
RCGT 1003M0-SAL																		▲	▲								

RCGT-SAL



Mittlere Bearbeitung  
Medium



RCGT-LN



Schlichten bis Feinschlichten  
Finishing to Fine Finishing

	1	2	3	4	5	6	7	8	9	10	11	12	13	14	15	16	17	18	19	20	21	22	23	24	25	26	27
RCGT 0602M0-LN																					▲						
RCGT 0803M0-LN																					▲						
RCGT 1003M0-LN																					▲						
RCGT 1204M0-LN																					▲						

RCGT

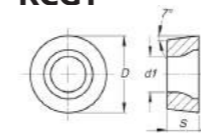

Maße Dimensions (mm)		Schnittdaten Cutting Details				Preis in €   Price in €																						
D	S	Re	d1	ap <sub>min</sub>	ap <sub>max</sub>	fn <sub>min</sub>	fn <sub>max</sub>	SW33105	SW22115	SW33115	SW22125	SW33125	SW44125	SW11425	SW22135	SW44740	SW11440	SW22705	SW22320	SW11610	SW00610	SW00910	SW12910	SW22410	SW11415	SW11515	SW12920	SW11420
								1	2	3	4	5	12	13	14	15	16	17	18	19	20	21	22	23	24	25	26	27
6,000	2,38	-	2,80	1,0	8,0	0,08	1,0													7,17	5,70							
8,000	3,18	-	3,40	1,0	8,0	0,08	1,0													7,77	6,19							
10,000	3,18	-	3,40	1,0	8,0	0,08	1,0													9,71	7,77							

Maße Dimensions (mm)		Schnittdaten Cutting Details				Preis in €   Price in €																						
D	S	Re	d1	ap <sub>min</sub>	ap <sub>max</sub>	fn <sub>min</sub>	fn <sub>max</sub>	SW33105	SW22115	SW33115	SW22125	SW33125	SW44125	SW11425	SW22135	SW44740	SW11440	SW22705	SW22320	SW11610	SW00610	SW00910	SW12910	SW22410	SW11415	SW11515	SW12920	SW11420
								1	2	3	4	5	12	13	14	15	16	17	18	19	20	21	22	23	24	25	26	27
6,000	2,38	-	2,80	0,50	2,00	0,05	0,20																					
8,000	3,18	-	3,40	0,50	2,50	0,05	0,25																					
10,000	3,18	-	4,40	1,00	3,00	0,10	0,30																					
12,000	4,76	-	4,40	1,00	3,50	0,10	0,35																					



Ersetzt alte Qualität in neue Qualität. SW22115 wird durch SW33115 ersetzt. SW22125 wird durch SW33125 ersetzt. SW22740 wird durch SW33740 ersetzt.  
*Replaces old grade into new grade. SW22115 replaces SW33115. SW22125 replaces SW33125. SW22740 replaces SW33740.*

Wettbewerbs-Qualitätsvergleich siehe Seite 150-152. *Competitor grade comparison see pages 150-152.* →

Wettbewerbs-Spanbrechervergleich siehe Seite 154-157. *Competitor chipbreaker comparison see pages 154-157.* →

Die neuen Qualitäten SW33... sind erst vollständig verfügbar wenn die Auslaufmodelle SW22... nicht mehr lagerhaltig sind.  
*The new Grades SW33... are only fully available when the discontinued models SW22... are no longer in stock*

RCMT

▲ empfohlene Qualität (auf Lager) recommended grade (on stock) ● alternative Qualität (auf Lager) alternative grade (on stock) ■ auf Lager bis ausverkauft Stock available until sold out

Bestellcode Ordering Code	Qualität   Grades																										
	P							M							K	N			S								
	SW33105	SW22115	SW33115	SW22125	SW33125	SW22740	SW33740	SW12910	SW44115	SW12920	SW22120	SW44125	SW11425	SW22135	SW44740	SW11440	SW22705	SW22320	SW11610	SW00610	SW00910	SW12910	SW22410	SW11415	SW11515	SW12920	SW11420
RCMT 0602M0-CP	1	2	3	4	5	6	7	8	9	10	11	12	13	14	15	16	17	18	19	20	21	22	23	24	25	26	27

RCMT-CP



Mittlere Bearbeitung  
Medium

RCMT-ST



Schruppen bis  
mittlere Bearbeitung  
Roughing to Medium

Bestellcode Ordering Code	Qualität   Grades																										
	P							M							K	N			S								
SW33105	SW22115	SW33115	SW22125	SW33125	SW22740	SW33740	SW12910	SW44115	SW12920	SW22120	SW44125	SW11425	SW22135	SW44740	SW11440	SW22705	SW22320	SW11610	SW00610	SW00910	SW12910	SW22410	SW11415	SW11515	SW12920	SW11420	
RCMT 0803M0-ST	1	2	3	4	5	6	7	8	9	10	11	12	13	14	15	16	17	18	19	20	21	22	23	24	25	26	27
RCMT 1003M0-ST	1	2	3	4	5	6	7	8	9	10	11	12	13	14	15	16	17	18	19	20	21	22	23	24	25	26	27
RCMT 10T3M0-ST	1	2	3	4	5	6	7	8	9	10	11	12	13	14	15	16	17	18	19	20	21	22	23	24	25	26	27
RCMT 1204M0-ST	1	2	3	4	5	6	7	8	9	10	11	12	13	14	15	16	17	18	19	20	21	22	23	24	25	26	27
RCMT 1606M0-ST	1	2	3	4	5	6	7	8	9	10	11	12	13	14	15	16	17	18	19	20	21	22	23	24	25	26	27
RCMT 2006M0-ST	1	2	3	4	5	6	7	8	9	10	11	12	13	14	15	16	17	18	19	20	21	22	23	24	25	26	27



RCMT-RF

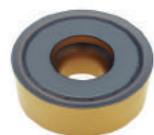

Schruppen bis  
mittlere Bearbeitung  
Roughing to Medium

Bestellcode Ordering Code	Qualität   Grades																										
	P							M							K	N			S								
SW33105	SW22115	SW33115	SW22125	SW33125	SW22740	SW33740	SW12910	SW44115	SW12920	SW22120	SW44125	SW11425	SW22135	SW44740	SW11440	SW22705	SW22320	SW11610	SW00610	SW00910	SW12910	SW22410	SW11415	SW11515	SW12920	SW11420	
RCMT 2507M0-RF	1	2	3	4	5	6	7	8	9	10	11	12	13	14	15	16	17	18	19	20	21	22	23	24	25	26	27



RCMT-RM



Schruppen bis  
mittlere Bearbeitung  
Roughing to Medium

Bestellcode Ordering Code	Qualität   Grades																										
	P							M							K	N			S								
SW33105	SW22115	SW33115	SW22125	SW33125	SW22740	SW33740	SW12910	SW44115	SW12920	SW22120	SW44125	SW11425	SW22135	SW44740	SW11440	SW22705	SW22320	SW11610	SW00610	SW00910	SW12910	SW22410	SW11415	SW11515	SW12920	SW11420	
RCMT 2006M0-RM	1	2	3	4	5	6	7	8	9	10	11	12	13	14	15	16	17	18	19	20	21	22	23	24	25	26	27

RCMT-MTS



Mittlere Bearbeitung  
Medium

Bestellcode Ordering Code	Qualität   Grades																										
	P							M							K	N			S								
SW33105	SW22115	SW33115	SW22125	SW33125	SW22740	SW33740	SW12910	SW44115	SW12920	SW22120	SW44125	SW11425	SW22135	SW44740	SW11440	SW22705	SW22320	SW11610	SW00610	SW00910	SW12910	SW22410	SW11415	SW11515	SW12920	SW11420	
RCMT 1606-MTS	1	2	3	4	5	6	7	8	9	10	11	12	13	14	15	16	17	18	19	20	21	22	23	24	25	26	27
RCMT 2006-MTS	1	2	3	4	5	6	7	8	9	10	11	12	13	14	15	16	17	18	19	20	21	22	23	24	25	26	27



Ersetzt alte Qualität in neue Qualität. SW22115 wird durch SW33115 ersetzt. SW22125 wird durch SW33125 ersetzt. SW22740 wird durch SW33740 ersetzt.  
Replaces old grade into new grade. SW22115 replaces SW33115. SW22125 replaces SW33125. SW22740 replaces SW33740.

Wettbewerbs-Qualitätsvergleich siehe Seite 150-152. Competitor grade comparison see pages 150-152. [→](#)  
Wettbewerbs-Spanbrechervergleich siehe Seite 154-157. Competitor chipbreaker comparison see pages 154-157. [→](#)

RCMT

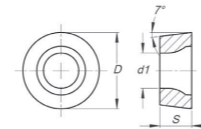

Maße Dimensions (mm)		Schnittdaten Cutting Details				Preis in €   Price in €																										
D	S	Re	d1	ap min	ap max	fn min	fn max	SW33105	SW22115	SW33115	SW22125	SW33125	SW22740	SW11425	SW44740	SW11440	SW22705	SW22320	SW11610	SW00610	SW00910	SW12910	SW22410	SW11415	SW11515	SW12920	SW11420					
6,000	2,38	-	2,80	0,50	2,40	0,04	0,17	1	2	3	4	5	6	13	15	16	17	18	19	20	21	22	23	24	25	26	27					
								6,38	7,30	6,38	7,30						6,38															

Maße Dimensions (mm)		Schnittdaten Cutting Details				Preis in €   Price in €																										
D	S	Re	d1	ap min	ap max	fn min	fn max	SW33105	SW22115	SW33115	SW22125	SW33125	SW22740	SW11425	SW44740	SW11440	SW22705	SW22320	SW11610	SW00610	SW00910	SW12910	SW22410	SW11415	SW11515	SW12920	SW11420					
8,000	3,18	-	3,40	0,80	3,20	0,10	0,80	1	2	3	4	5	6	13	15	16	17	18	19	20	21	22	23	24	25	26	27					
								6,38	7,30	6,38	7,30						6,38															
10,000	3,18	-	3,40	1,00	4,00	0,12	1,00	1	2	3	4	5	6	13	15	16	17	18	19	20	21	22	23	24	25	26	27					
								6,38	7,30	6,38	7,30						6,38															
10,000	3,97	-	4,40	1,00	4,00	0,16	1,40	1	2	3	4	5	6	13	15	16	17	18	19	20	21	22	23	24	25	26	27					
								6,38	7,30	6,38	7,30						6,38															
12,000	4,76	-	4,40	1,20	4,80	0,20	1,80	1	2	3	4	5	6	13	15	16	17	18	19	20	21	22	23	24	25	26	27					
								7,19	8,28	7,19	8,28						7,19															
16,000	6,35	-	5,50	1,60	6,40	0,25	2,30	1	2	3	4	5	6	13	15	16	17	18	19	20	21	22	23	24	25	26	27					
								15,68	18,12	15,68	18,12						15,68															
20,000	6,35	-	6,50	2,00	8,00	0,30	3,00	1	2	3	4	5	6	13	15	16	17	18	19	20	21	22	23	24	25	26	27					
								20,55	23,64	20,55	23,64						20,55	20,55														

Maße Dimensions (mm)		Schnittdaten Cutting Details				Preis in €   Price in €																										
D	S	Re	d1	ap min	ap max	fn min	fn max	SW33105	SW22115	SW33115	SW22125	SW33125	SW22740	SW11425	SW44740	SW11440	SW22705	SW22320	SW11610	SW00610	SW00910	SW12910	SW22410	SW11415	SW11515	SW12920	SW11420					
25,000	7,94	-	7,20	2,50	10,00	0,25	2,50	1	2	3	4	5	6	13	15	16	17	18	19	20	21	22	23	24	25	26	27					
										32,18	32,18																					

Maße Dimensions (mm)		Schnittdaten Cutting Details				Preis in €   Price in €																										
D	S	Re	d1	ap min	ap max	fn min	fn max	SW33105	SW22115	SW33115	SW22125	SW33125	SW22740	SW11425	SW44740	SW11440	SW22705	SW22320	SW11610	SW00610	SW00910	SW12910	SW22410	SW11415	SW11515	SW12920	SW11420					
20,000	6,35	-	6,50	2,00	8,00	0,13	0,63	1	2	3	4	5	6	13	15	16	17	18	19	20	21	22	23	24	25	26	27					
										22,72	22,72																					

Maße Dimensions (mm)		Schnittdaten Cutting Details				Preis in €   Price in €																										
D	S	Re	d1	ap min	ap max	fn min	fn max	SW33105	SW22115	SW33115	SW22125	SW33125	SW22740	SW11425	SW44740	SW11440	SW22705	SW22320	SW11610	SW00610	SW00910	SW12910	SW22410	SW11415	SW11515	SW12920	SW11420					
16,000	6,35	-	5,50	1,0	5,0	0,2	0,45	1	2	3	4	5	6	13	15	16	17	18	19	20	21	22	23	24	25	26	27					
																									14,60							
20,000	6,35	-	6,50	1,0	5,0	0,2	0,45	1	2	3	4	5	6	13	15	16	17	18	19	20	21	22	23	24	25	26	27					
																												23,14				

Die neuen Qualitäten SW33... sind erst vollständig verfügbar wenn die Auslaufmodelle SW22... nicht mehr lagerhaltig sind.  
Die new Grades SW33... are only fully available when the discontinued models SW22... are no longer in stock

RCMX

▲ empfohlene Qualität (auf Lager) **●** alternative Qualität (auf Lager) ■ auf Lager bis ausverkauft  
 recommended grade (on stock) alternative grade (on stock) Stock available until sold out

Bestellcode Ordering Code	Qualität   Grades																										
	P						M										K		N			S					
	SW33105	SW22115	SW33115	SW22125	SW33125	SW22740	SW33740	SW12910	SW44115	SW12920	SW22120	SW44125	SW11425	SW22135	SW44740	SW11440	SW22705	SW22320	SW11610	SW00610	SW00910	SW12910	SW22410	SW11415	SW11515	SW12920	SW11420

RCMX-ST



Schruppen bis mittlere Bearbeitung  
 Roughing to Medium

	1	2	3	4	5	6	7	8	9	10	11	12	13	14	15	16	17	18	19	20	21	22	23	24	25	26	27
RCMX 1003M0-ST	■			▲																							
RCMX 1204M0-ST				▲																							
RCMX 1606M0-ST				▲																							
RCMX 2006M0-ST				▲																							
RCMX 2507M0-ST	●			▲																							
RCMX 3009M0-ST		●		▲																							
RCMX 3209M0-ST	●			▲																							

NEW

RCMX-RM



Schruppen bis mittlere Bearbeitung  
 Roughing to Medium

	1	2	3	4	5	6	7	8	9	10	11	12	13	14	15	16	17	18	19	20	21	22	23	24	25	26	27
RCMX 3209M0-RM	■	●		▲																							

NEW

RCMX-RR



Schruppen bis mittlere Bearbeitung  
 Roughing to Medium

	1	2	3	4	5	6	7	8	9	10	11	12	13	14	15	16	17	18	19	20	21	22	23	24	25	26	27
RCMX 2507M0-RR	■	●		▲																							
RCMX 3209M0-RR	■	●		▲																							



Ersetzt alte Qualität in neue Qualität. SW22115 wird durch SW33115 ersetzt. SW22125 wird durch SW33125 ersetzt. SW22740 wird durch SW33740 ersetzt.  
 Replaces old grade into new grade. SW22115 replaces SW33115. SW22125 replaces SW33125. SW22740 replaces SW33740.

Wettbewerbs-Qualitätsvergleich siehe Seite 150-152. Competitor grade comparison see pages 150-152. [→](#)  
 Wettbewerbs-Spanbrechervergleich siehe Seite 154-157. Competitor chipbreaker comparison see pages 154-157. [→](#)

RCMX

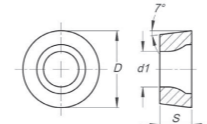

Maße Dimensions (mm)		Schnittdaten Cutting Details				Preis in €   Price in €																				
D	S	Re	d1	ap <sub>min</sub>	ap <sub>max</sub>	fn <sub>min</sub>	fn <sub>max</sub>	SW33105	SW22115	SW33115	SW22125	SW33125	SW22740	SW33740	SW12910	SW00910	SW12910	SW22410	SW11415	SW11515	SW12920	SW11420				
								1	2	3	4	5	6	7	8	9	22	23	24	25	26	27				
10,000	3,18	-	3,60	1,00	4,00	0,10	1,00		7,73		7,73	7,30	7,73													
12,000	4,76	-	4,20	1,20	4,80	0,12	1,20				8,87	8,28														
16,000	6,35	-	5,20	1,60	6,40	0,16	1,60				17,31	18,12														
20,000	6,35	-	6,50	2,00	8,00	0,20	2,00				22,17	25,42														
25,000	7,94	-	7,20	2,50	10,00	0,25	2,50	29,48		29,48	34,07															
30,000	9,55	-	10,00	3,00	11,00	0,30	2,80			50,84		50,84														
32,000	9,52	-	9,50	3,20	12,80	0,32	3,20	49,76		49,76	57,18															

	1	2	3	4	5	6	7	8	9	22	23	24	25	26	27											
32,000	9,52	-	9,50	3,20	13,00	0,80	2,50		49,76	57,33	49,76	57,33														

	1	2	3	4	5	6	7	8	9	22	23	24	25	26	27											
25,000	7,94	-	7,20	3,20	8,00	0,80	2,50	29,48	34,07	29,48	34,07															
32,000	9,52	-	9,50	3,20	13,00	0,80	2,50	49,76	57,33	49,76	57,33															

Die neuen Qualitäten SW33... sind erst vollständig verfügbar wenn die Auslaufmodelle SW22... nicht mehr lagerhaltig sind.  
 Die new Grades SW33... are only fully available when the discontinued models SW22... are no longer in stock





SCMT

▲ empfohlene Qualität (auf Lager) **●** alternative Qualität (auf Lager) ■ auf Lager bis ausverkauft  
*recommended grade (on stock) alternative grade (on stock) Stock available until sold out*

Bestellcode Ordering Code	Qualität   Grades																										
	P						M							K		N			S								
	SW33105	SW22115	SW33115	SW22125	SW33125	SW22740	SW33740	SW12910	SW44115	SW12920	SW22120	SW44125	SW11425	SW22135	SW44740	SW11440	SW22705	SW22320	SW11610	SW00610	SW00910	SW12910	SW22410	SW11415	SW11515	SW12920	SW11420

SCMT-MP



Mittlere Bearbeitung  
Medium

	1	2	3	4	5	6	7	8	9	10	11	12	13	14	15	16	17	18	19	20	21	22	23	24	25	26	27
SCMT 09T304-MP	■	▲	■	●																							
SCMT 09T308-MP	■	▲	■	●																							
SCMT 120404-MP	■	▲	■	●																							
SCMT 120408-MP	■	▲	■	●																							
SCMT 120412-MP	■	▲	■	●																							

SCMT-MM



Mittlere Bearbeitung  
Medium

	1	2	3	4	5	6	7	8	9	10	11	12	13	14	15	16	17	18	19	20	21	22	23	24	25	26	27
SCMT 09T304-MM									▲	●																●	
SCMT 09T308-MM									▲	●																●	
SCMT 120404-MM									▲	●																●	
SCMT 120408-MM									▲	●																●	
SCMT 120412-MM									▲	●																●	

SCMT-MK



Mittlere Bearbeitung  
Medium

	1	2	3	4	5	6	7	8	9	10	11	12	13	14	15	16	17	18	19	20	21	22	23	24	25	26	27
SCMT 09T304-MK																	▲	●									
SCMT 09T308-MK																	▲	●									
SCMT 120408-MK																	●	▲									



Ersetzt alte Qualität in neue Qualität. SW22115 wird durch SW33115 ersetzt. SW22125 wird durch SW33125 ersetzt. SW22740 wird durch SW33740 ersetzt.  
*Replaces old grade into new grade. SW22115 replaces SW33115. SW22125 replaces SW33125. SW22740 replaces SW33740.*

Wettbewerbs-Qualitätsvergleich siehe Seite 150-152. *Competitor grade comparison see pages 150-152.* →

Wettbewerbs-Spanbrechervergleich siehe Seite 154-157. *Competitor chipbreaker comparison see pages 154-157.* →

SCMT

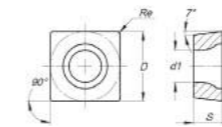

Maße Dimensions (mm)		Schnittdaten Cutting Details				Preis in €   Price in €																										
D	S	Re	d1	ap min	ap max	fn min	fn max	SW33105	SW22115	SW33115	SW22125	SW33125	SW22740	SW33740	SW12910	SW44115	SW12920	SW22705	SW22320	SW11610	SW00610	SW00910	SW12910	SW22410	SW11415	SW11515	SW12920	SW11420				
9,525	3,97	0,40	4,40	0,25	3,00	0,08	0,23	7,19	8,28	7,19	8,28																					
9,525	3,97	0,80	4,40	0,50	3,00	0,10	0,40	7,19	8,28	7,19	8,28																					
12,700	4,76	0,40	5,50	0,30	3,60	0,09	0,27	8,60	9,95	8,60	9,95																					
12,700	4,76	0,80	5,50	0,60	3,60	0,12	0,45	8,60	9,95	8,60	9,95																					
12,700	4,76	1,20	5,50	0,72	3,60	0,14	0,60	8,60	9,95	8,60	9,95																					

Maße Dimensions (mm)		Schnittdaten Cutting Details				Preis in €   Price in €																										
D	S	Re	d1	ap min	ap max	fn min	fn max	SW33105	SW22115	SW33115	SW22125	SW33125	SW22740	SW33740	SW12910	SW44115	SW12920	SW22705	SW22320	SW11610	SW00610	SW00910	SW12910	SW22410	SW11415	SW11515	SW12920	SW11420				
9,525	3,97	0,40	4,40	0,25	3,00	0,08	0,23									8,28	7,19											7,19				
9,525	3,97	0,80	4,40	0,50	3,00	0,10	0,40									8,28	7,19											7,19				
12,700	4,76	0,40	5,50	0,30	3,60	0,09	0,27									9,95	8,60											8,60				
12,700	4,76	0,80	5,50	0,60	3,60	0,12	0,45									9,95	8,60											8,60				
12,700	4,76	1,20	5,50	0,72	3,60	0,14	0,60									9,95	8,60											8,60				

Maße Dimensions (mm)		Schnittdaten Cutting Details				Preis in €   Price in €																										
D	S	Re	d1	ap min	ap max	fn min	fn max	SW33105	SW22115	SW33115	SW22125	SW33125	SW22740	SW33740	SW12910	SW44115	SW12920	SW22705	SW22320	SW11610	SW00610	SW00910	SW12910	SW22410	SW11415	SW11515	SW12920	SW11420				
9,525	3,97	0,40	4,40	0,25	3,00	0,08	0,23																						7,19	7,19		
9,525	3,97	0,80	4,40	0,50	3,00	0,10	0,40																						7,19	7,19		
12,700	4,76	0,80	5,50	0,60	3,60	0,12	0,45																						8,60	8,60		

Die neuen Qualitäten SW33... sind erst vollständig verfügbar wenn die Auslaufmodelle SW22... nicht mehr lagerhaltig sind.  
*The new Grades SW33... are only fully available when the discontinued models SW22... are no longer in stock*

## 2 POSITIVE DREHPLATTEN

### SCGT

▲ empfohlene Qualität (auf Lager) **recommended grade (on stock)** ● alternative Qualität (auf Lager) **alternative grade (on stock)** ■ auf Lager bis ausverkauft **Stock available until sold out**

**NEW**

SCGT-LN



Mittlere Bearbeitung bis Schlichten  
Medium to Finishing

Bestellcode Ordering Code	Qualität   Grades																											
	P						M										K		N			S						
	SW33105	SW22115	SW33115	SW22125	SW33125	SW22740	SW33740	SW12910	SW44115	SW12920	SW22120	SW44125	SW11425	SW22135	SW44740	SW11440	SW22705	SW22320	SW11610	SW00610	SW00910	SW12910	SW22410	SW11415	SW11515	SW12920	SW11420	
1	2	3	4	5	6	7	8	9	10	11	12	13	14	15	16	17	18	19	20	21	22	23	24	25	26	27		
SCGT 09T304-LN																												
SCGT 09T308-LN																												
SCGT 120404-LN																												
SCGT 120408-LN																												

### SCGT

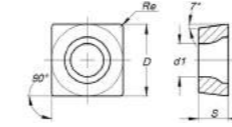

Maße Dimensions (mm)		Schnittdaten Cutting Details				Preis in €   Price in €																										
D	S	Re	d1	ap min	ap max	fn min	fn max	SW33105	SW22115	SW33115	SW22125	SW33125	SW44125	SW11425	SW22135	SW44740	SW11440	SW22705	SW22320	SW11610	SW00610	SW00910	SW12910	SW22410	SW11415	SW11515	SW12920	SW11420				
								1	2	3	4	5	12	13	14	15	16	17	18	19	20	21	22	23	24	25	26	27				
9,525	3,97	0,40	4,40	0,10	4,00	0,10	0,26																									
9,525	3,97	0,80	4,40	0,10	5,00	0,15	0,40																									
12,700	4,76	0,40	5,50	0,10	5,00	0,10	0,26																									
12,700	4,76	0,80	5,50	0,10	5,00	0,15	0,50																									



Ersetzt alte Qualität in neue Qualität. SW22115 wird durch SW33115 ersetzt. SW22125 wird durch SW33125 ersetzt. SW22740 wird durch SW33740 ersetzt.  
Replaces old grade into new grade. SW22115 replaces SW33115. SW22125 replaces SW33125. SW22740 replaces SW33740.

Wettbewerbs-Qualitätsvergleich siehe Seite 150-152. Competitor grade comparison see pages 150-152. →

Wettbewerbs-Spanbrechervergleich siehe Seite 154-157. Competitor chipbreaker comparison see pages 154-157. →

Die neuen Qualitäten SW33... sind erst vollständig verfügbar wenn die Auslaufmodelle SW22... nicht mehr lagerhaltig sind.  
Die new Grades SW33... are only fully available when the discontinued models SW22... are no longer in stock



TCMT

▲ empfohlene Qualität (auf Lager) recommended grade (on stock) ● alternative Qualität (auf Lager) alternative grade (on stock) ■ auf Lager bis ausverkauft Stock available until sold out

Bestellcode Ordering Code	Qualität   Grades																											
	P							M							K		N			S								
	SW33105	SW22115	SW33115	SW22125	SW33125	SW22740	SW33740	SW12910	SW44115	SW12920	SW22120	SW44125	SW11425	SW22135	SW44740	SW11440	SW22705	SW22320	SW11610	SW00610	SW00910	SW12910	SW22410	SW11415	SW11515	SW12920	SW11420	
1	2	3	4	5	6	7	8	9	10	11	12	13	14	15	16	17	18	19	20	21	22	23	24	25	26	27		
TCMT 06T102-FP				▲																								
TCMT 06T104-FP	■	▲	■	●																								
TCMT 06T108-FP	■	▲	■	●																								
TCMT 090202-FP				■	▲																							
TCMT 090204-FP	■	▲	■	●																								
TCMT 110202-FP				■	▲																							
TCMT 110204-FP	■	▲	■	●																								
TCMT 110208-FP	■	▲	■	●																								
TCMT 110302-FP				■	▲																							
TCMT 110304-FP	■	▲	■	●																								
TCMT 110308-FP	■	▲	■	●																								
TCMT 16T304-FP	■	▲	■	●																								

TCMT-FP



Schlichten  
Finishing

TCMT-FM

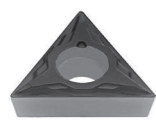

Schlichten  
Finishing

Bestellcode Ordering Code	Qualität   Grades																										
	1	2	3	4	5	6	7	8	9	10	11	12	13	14	15	16	17	18	19	20	21	22	23	24	25	26	27
TCMT 06T102-FM										●	▲																▲
TCMT 06T104-FM										●	▲																▲
TCMT 06T108-FM										●	▲																▲
TCMT 090202-FM										●	▲																▲
TCMT 090204-FM										●	▲																▲
TCMT 110202-FM										●	▲																▲
TCMT 110204-FM										●	▲																▲
TCMT 110208-FM										●	▲																▲
TCMT 110302-FM										●	▲																▲
TCMT 110304-FM										●	▲																▲
TCMT 110308-FM										●	▲																▲
TCMT 16T304-FM										●	▲																▲



Ersetzt alte Qualität in neue Qualität. SW22115 wird durch SW33115 ersetzt. SW22125 wird durch SW33125 ersetzt. SW22740 wird durch SW33740 ersetzt.  
Replaces old grade into new grade. SW22115 replaces SW33115. SW22125 replaces SW33125. SW22740 replaces SW33740.

Wettbewerbs-Qualitätsvergleich siehe Seite 150-152. Competitor grade comparison see pages 150-152. →  
Wettbewerbs-Spanbrechervergleich siehe Seite 154-157. Competitor chipbreaker comparison see pages 154-157. →

TCMT



Maße Dimensions (mm)		Schnittdaten Cutting Details				Preis in €   Price in €																										
D	S	Re	d1	ap min	ap max	fn min	fn max	SW33105	SW22115	SW33115	SW22125	SW33125	SW22740	SW33740	SW12910	SW44115	SW12920	SW22120	SW44125	SW11425	SW22135	SW44740	SW12910	SW22410	SW11415	SW11515	SW12920	SW11420				
								1	2	3	4	5	6	7	8	9	10	11	12	13	14	15	22	23	24	25	26	27				
3,970	1,98	0,20	2,15	0,06	1,50	0,03	0,11				5,25	6,06																				
3,970	1,98	0,40	2,15	0,08	1,50	0,05	0,17	5,25	6,06	5,25	6,06																					
3,970	1,98	0,80	2,15	0,11	1,50	0,06	0,23	5,25	6,06	5,25	6,06																					
5,560	2,38	0,20	2,50	0,06	1,70	0,03	0,13				6,92	7,63																				
5,560	2,38	0,40	2,50	0,10	1,70	0,05	0,19	6,92	7,63	6,92	7,63																					
6,350	2,38	0,20	2,80	0,06	1,70	0,03	0,13				6,92	8,00																				
6,350	2,38	0,40	2,80	0,10	1,70	0,05	0,19	6,92	8,00	6,92	8,00																					
6,350	2,38	0,80	2,80	0,13	1,70	0,07	0,26	6,92	8,00	6,92	8,00																					
6,350	3,18	0,20	2,80	0,06	1,70	0,03	0,13				6,92	8,00																				
6,350	3,18	0,40	2,80	0,10	1,70	0,05	0,19	6,92	8,00	6,92	8,00																					
6,350	3,18	0,80	2,80	0,13	1,70	0,07	0,26	6,92	8,00	6,92	8,00																					
9,525	3,97	0,40	4,40	0,11	2,00	0,06	0,23	7,19	8,28	7,19	8,28																					

								1	2	3	4	5	6	7	8	9	10	11	12	13	14	15	22	23	24	25	26	27
3,970	1,98	0,20	2,15	0,06	1,50	0,03	0,11											5,25	6,06								5,25	
3,970	1,98	0,40	2,15	0,08	1,50	0,05	0,17											5,25	6,06								5,25	
3,970	1,98	0,80	2,15	0,11	1,50	0,06	0,23											5,25	6,06								5,25	
5,560	2,38	0,20	2,50	0,06	1,70	0,03	0,13											6,92	7,63								6,92	
5,560	2,38	0,40	2,50	0,10	1,70	0,05	0,19											6,92	7,63								6,92	
6,350	2,38	0,20	2,80	0,06	1,70	0,03	0,13											6,92	8,00								6,92	
6,350	2,38	0,40	2,80	0,10	1,70	0,05	0,19											6,92	8,00								6,92	
6,350	2,38	0,80	2,80	0,13	1,70	0,07	0,26											6,92	8,00								6,92	
6,350	3,18	0,20	2,80	0,06	1,70	0,03	0,13											6,92	8,00								6,92	
6,350	3,18	0,40	2,80	0,10	1,70	0,05	0,19											6,92	8,00								6,92	
6,350	3,18	0,80	2,80	0,13	1,70	0,07	0,26											6,92	8,00								6,92	
9,525	3,97	0,40	4,40	0,11	2,00	0,06	0,23											7,19	8,28								7,19	

Die neuen Qualitäten SW33... sind erst vollständig verfügbar wenn die Auslaufmodelle SW22... nicht mehr lagerhaltig sind.  
Die new Grades SW33... are only fully available when the discontinued models SW22... are no longer in stock





TCMT

▲ empfohlene Qualität (auf Lager) recommended grade (on stock) ● alternative Qualität (auf Lager) alternative grade (on stock) ■ auf Lager bis ausverkauft Stock available until sold out

Bestellcode Ordering Code	Qualität   Grades																										
	P						M									K		N			S						
	SW33105	SW22115	SW33115	SW22125	SW33125	SW22740	SW33740	SW12910	SW44115	SW12920	SW22120	SW44125	SW11425	SW22135	SW44740	SW11440	SW22705	SW22320	SW11610	SW00610	SW00910	SW12910	SW22410	SW11415	SW11515	SW12920	SW11420
TCMT 090204-MM							▲	▲	▲																		▲
TCMT 090208-MM							▲	▲	▲																		▲
TCMT 110204-MM							▲	▲	▲												●						▲
TCMT 110208-MM							▲	▲	▲													●					▲
TCMT 110304-MM							▲	▲	▲																		▲
TCMT 110308-MM							▲	▲	▲																		▲
TCMT 16T304-MM							▲	▲	▲													●					▲
TCMT 16T308-MM							▲	▲	▲													●					▲
TCMT 16T312-MM							▲	▲	▲																		▲
TCMT 220408-MM							▲	▲																			▲

TCMT-MM



Mittlere Bearbeitung  
Medium

Bestellcode Ordering Code	Qualität   Grades																												
	S																												
TCMT 090204-MK																											●	▲	
TCMT 090208-MK																												●	▲
TCMT 110204-MK																												●	▲
TCMT 110208-MK																												●	▲
TCMT 110304-MK																												●	▲
TCMT 110308-MK																												●	▲
TCMT 16T304-MK																												●	▲
TCMT 16T308-MK																												●	▲
TCMT 16T312-MK																												●	▲
TCMT 220408-MK																												●	▲

TCMT-MK

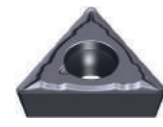

Mittlere Bearbeitung  
Medium

TCMT-MW



Mittlere Bearbeitung bis Schlichten Wiper  
Medium to Finishing Wiper

Bestellcode Ordering Code	Qualität   Grades																											
	S																											
TCMT 110208-MW		▲	▲																									▲
TCMT 110308-MW		▲	▲																			▲						▲
TCMT 16T308-MW		▲	▲																			▲						▲

TCMT



Maße Dimensions (mm)		Schnittdaten Cutting Details				Preis in €   Price in €																										
D	S	Re	d1	ap <sub>min</sub>	ap <sub>max</sub>	fn <sub>min</sub>	fn <sub>max</sub>	SW33105	SW22115	SW33115	SW22125	SW33125	SW22740	SW33740	SW12910	SW44115	SW12920	SW22705	SW22320	SW11610	SW00610	SW00910	SW12910	SW22410	SW11415	SW11515	SW12920	SW11420				
5,560	2,38	0,40	2,50	0,19	2,25	0,06	0,17									6,92	7,63	6,92											6,92			
5,560	2,38	0,80	2,50	0,38	2,25	0,08	0,23									7,63	6,92												6,92			
6,350	2,38	0,40	2,80	0,21	2,50	0,06	0,19									6,92	8,00	6,92									6,92	6,92				
6,350	2,38	0,80	2,80	0,42	2,50	0,09	0,26									6,92	8,00	6,92										6,92				
6,350	3,18	0,40	2,80	0,21	2,50	0,06	0,19									6,92	8,00	6,92										6,92				
6,350	3,18	0,80	2,80	0,42	2,50	0,09	0,40									6,92	8,00	6,92										6,92				
9,525	3,97	0,40	4,40	0,25	3,00	0,08	0,23										8,28	7,19										7,19				
9,525	3,97	0,80	4,40	0,50	3,00	0,10	0,45									7,19	8,28	7,19								7,19	7,19					
9,525	3,97	1,20	4,40	0,60	3,00	0,12	0,60									7,19	8,28	7,19										7,19				
12,700	4,76	0,80	5,50	0,60	3,60	0,12	0,45										13,52	11,63										11,63				

Maße Dimensions (mm)		Schnittdaten Cutting Details				Preis in €   Price in €																										
D	S	Re	d1	ap <sub>min</sub>	ap <sub>max</sub>	fn <sub>min</sub>	fn <sub>max</sub>	SW33105	SW22115	SW33115	SW22125	SW33125	SW22740	SW33740	SW12910	SW44115	SW12920	SW22705	SW22320	SW11610	SW00610	SW00910	SW12910	SW22410	SW11415	SW11515	SW12920	SW11420				
5,560	2,38	0,40	2,50	0,19	2,25	0,06	0,17																						6,92	6,92		
5,560	2,38	0,80	2,50	0,38	2,25	0,08	0,23																						6,92	6,92		
6,350	2,38	0,40	2,80	0,21	2,50	0,06	0,19																						6,92	6,92		
6,350	2,38	0,80	2,80	0,42	2,50	0,09	0,26																						6,92	6,92		
6,350	3,18	0,40	2,80	0,21	2,50	0,06	0,19																						6,92	6,92		
6,350	3,18	0,80	2,80	0,42	2,50	0,09	0,40																						6,92	6,92		
9,525	3,97	0,40	4,40	0,25	3,00	0,08	0,23																						7,19	7,19		
9,525	3,97	0,80	4,40	0,50	3,00	0,10	0,45																						7,19	7,19		
9,525	3,97	1,20	4,40	0,60	3,00	0,12	0,60																						7,19	7,19		
12,700	4,76	0,80	5,50	0,60	3,60	0,12	0,45																							11,63	11,63	

Maße Dimensions (mm)		Schnittdaten Cutting Details				Preis in €   Price in €																										
D	S	Re	d1	ap <sub>min</sub>	ap <sub>max</sub>	fn <sub>min</sub>	fn <sub>max</sub>	SW33105	SW22115	SW33115	SW22125	SW33125	SW22740	SW33740	SW12910	SW44115	SW12920	SW22705	SW22320	SW11610	SW00610	SW00910	SW12910	SW22410	SW11415	SW11515	SW12920	SW11420				
6,350	2,38	0,80	2,80	0,50	3,00	0,15	0,50			7,46	8,60																		7,46	7,46		
6,350	3,18	0,80	2,80	0,50	3,00	0,15	0,50			7,46	8,60																		7,46	7,46		
9,525	3,97	0,80	4,40	0,50	4,00	0,15	0,50			7,73	8,92																		7,19	7,19		



Ersetzt alte Qualität in neue Qualität. SW22115 wird durch SW33115 ersetzt. SW22125 wird durch SW33125 ersetzt. SW22740 wird durch SW33740 ersetzt.  
Replaces old grade into new grade. SW22115 replaces SW33115. SW22125 replaces SW33125. SW22740 replaces SW33740.

Wettbewerbs-Qualitätsvergleich siehe Seite 150-152. Competitor grade comparison see pages 150-152. →

Wettbewerbs-Spanbrechervergleich siehe Seite 154-157. Competitor chipbreaker comparison see pages 154-157. →

Die neuen Qualitäten SW33... sind erst vollständig verfügbar wenn die Auslaufmodelle SW22... nicht mehr lagerhaltig sind.  
Die new Grades SW33... are only fully available when the discontinued models SW22... are no longer in stock



VBMT

▲ empfohlene Qualität (auf Lager) recommended grade (on stock) ● alternative Qualität (auf Lager) alternative grade (on stock) ■ auf Lager bis ausverkauft Stock available until sold out

Bestellcode Ordering Code	Qualität   Grades																										
	P						M						K		N			S									
	SW33105	SW22115	SW33115	SW22125	SW33125	SW22740	SW33740	SW12910	SW44115	SW12920	SW22120	SW44125	SW11425	SW22135	SW44740	SW11440	SW22705	SW22320	SW11610	SW00610	SW00910	SW12910	SW22410	SW11415	SW11515	SW12920	SW11420



	1	2	3	4	5	6	7	8	9	10	11	12	13	14	15	16	17	18	19	20	21	22	23	24	25	26	27
VBMT 160404-MP	■	●	■	▲				●		●																	
VBMT 160408-MP	■	●	■	▲				●		●																	
VBMT 160412-MP	■	●	■	▲																							

VBMT-MM



	1	2	3	4	5	6	7	8	9	10	11	12	13	14	15	16	17	18	19	20	21	22	23	24	25	26	27
VBMT 160404-MM								●	▲	●												●				▲	
VBMT 160408-MM								●	▲	●												●				▲	
VBMT 160412-MM								▲	●																	▲	

VBMT-MK



	1	2	3	4	5	6	7	8	9	10	11	12	13	14	15	16	17	18	19	20	21	22	23	24	25	26	27
VBMT 160404-MK																		●	▲								
VBMT 160408-MK																		●	▲								
VBMT 160412-MK																		●	▲								



Ersetzt alte Qualität in neue Qualität. SW22115 wird durch SW33115 ersetzt. SW22125 wird durch SW33125 ersetzt. SW22740 wird durch SW33740 ersetzt.  
Replaces old grade into new grade. SW22115 replaces SW33115. SW22125 replaces SW33125. SW22740 replaces SW33740.

Wettbewerbs-Qualitätsvergleich siehe Seite 150-152. Competitor grade comparison see pages 150-152. →

Wettbewerbs-Spanbrechervergleich siehe Seite 154-157. Competitor chipbreaker comparison see pages 154-157. →

VBMT

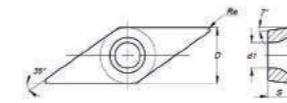

Maße Dimensions (mm)		Schnittdaten Cutting Details				Preis in €   Price in €																										
D	S	Re	d1	ap min	ap max	fn min	fn max	SW33105	SW22115	SW33115	SW22125	SW33125	SW22740	SW12910	SW44115	SW12920	SW22120	SW11425	SW22135	SW22705	SW22320	SW11610	SW12910	SW22410	SW11415	SW11515	SW12920	SW11420				
								1	2	3	4	5	7	8	9	10	11	13	14	17	18	19	22	23	24	25	26	27				
9,525	4,76	0,40	4,40	0,23	2,70	0,07	0,20	13,25	15,41	13,25	15,41			13,25		13,25																
9,525	4,76	0,80	4,40	0,45	2,70	0,09	0,27	13,25	15,41	13,25	15,41			13,25		13,25																
9,525	4,76	1,20	4,40	0,54	2,70	0,11	0,32	13,25	15,41	13,25	15,41																					

Maße Dimensions (mm)		Schnittdaten Cutting Details				Preis in €   Price in €																										
D	S	Re	d1	ap min	ap max	fn min	fn max	SW33105	SW22115	SW33115	SW22125	SW33125	SW22740	SW12910	SW44115	SW12920	SW22120	SW11425	SW22135	SW22705	SW22320	SW11610	SW12910	SW22410	SW11415	SW11515	SW12920	SW11420				
								1	2	3	4	5	7	8	9	10	11	13	14	17	18	19	22	23	24	25	26	27				
9,525	4,76	0,40	4,40	0,23	2,70	0,07	0,20									13,25	15,41	13,25						13,25				13,25				
9,525	4,76	0,80	4,40	0,45	2,70	0,09	0,27									13,25	15,41	13,25						13,25				13,25				
9,525	4,76	1,20	4,40	0,54	2,70	0,11	0,32									15,41	13,25											13,25				

Maße Dimensions (mm)		Schnittdaten Cutting Details				Preis in €   Price in €																										
D	S	Re	d1	ap min	ap max	fn min	fn max	SW33105	SW22115	SW33115	SW22125	SW33125	SW22740	SW12910	SW44115	SW12920	SW22120	SW11425	SW22135	SW22705	SW22320	SW11610	SW12910	SW22410	SW11415	SW11515	SW12920	SW11420				
								1	2	3	4	5	7	8	9	10	11	13	14	17	18	19	22	23	24	25	26	27				
9,525	4,76	0,40	4,40	0,23	2,70	0,07	0,20																					13,25	13,25			
9,525	4,76	0,80	4,40	0,45	2,70	0,09	0,27																					13,25	13,25			
9,525	4,76	1,20	4,40	0,54	2,70	0,11	0,32																					13,25	13,25			

Die neuen Qualitäten SW33... sind erst vollständig verfügbar wenn die Auslaufmodelle SW22... nicht mehr lagerhaltig sind.  
Die new Grades SW33... are only fully available when the discontinued models SW22... are no longer in stock





VCGT

▲ empfohlene Qualität (auf Lager) **●** alternative Qualität (auf Lager) ■ auf Lager bis ausverkauft  
 recommended grade (on stock) alternative grade (on stock) Stock available until sold out

Bestellcode Ordering Code	Qualität   Grades																										
	P							M								K		N			S						
	SW33105	SW22115	SW33115	SW22125	SW33125	SW22740	SW33740	SW12910	SW44115	SW12920	SW22120	SW44125	SW11425	SW22135	SW44740	SW11440	SW22705	SW22320	SW11610	SW00610	SW00910	SW12910	SW22410	SW11415	SW11515	SW12920	SW11420
VCGT 110301-FS							▲		●												●					▲	
VCGT 110302-FS							▲		●												●					▲	
VCGT 110304-FS							▲		●												●					▲	



VCGT-FS  
Schichten bis Feinschichten  
Finishing to Fine Finishing

	1	2	3	4	5	6	7	8	9	10	11	12	13	14	15	16	17	18	19	20	21	22	23	24	25	26	27	
VCGT 110301-LN																						▲						
VCGT 110302-LN																						▲						
VCGT 110304-LN																						▲						
VCGT 110308-LN																						▲						
VCGT 130302-LN																						▲						
VCGT 130304-LN																						▲						
VCGT 160402-LN																						▲						
VCGT 160404-LN																						▲						
VCGT 160408-LN																						▲						
VCGT 160412-LN																						▲						
VCGT 220530-LN																						▲						



NEW VCGT-LN  
Mittlere Bearbeitung bis Schlichten  
Medium to Finishing

Ersetzt alte Qualität in neue Qualität. SW22115 wird durch SW33115 ersetzt. SW22125 wird durch SW33125 ersetzt. SW22740 wird durch SW33740 ersetzt.  
 Replaces old grade into new grade. SW22115 replaces SW33115. SW22125 replaces SW33125. SW22740 replaces SW33740.

Wettbewerbs-Qualitätsvergleich siehe Seite 150-152. Competitor grade comparison see pages 150-152. →  
 Wettbewerbs-Spanbrechervergleich siehe Seite 154-157. Competitor chipbreaker comparison see pages 154-157. →

VCGT

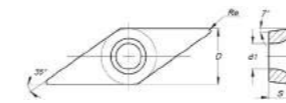

Maße Dimensions (mm)		Schnittdaten Cutting Details		Preis in €   Price in €																										
D	S	Re	d1	ap <sub>min</sub>	ap <sub>max</sub>	fn <sub>min</sub>	fn <sub>max</sub>	SW33105	SW22115	SW33115	SW22125	SW33125	SW22740	SW33740	SW12910	SW44115	SW12920	SW22705	SW22320	SW11610	SW00610	SW00910	SW12910	SW22410	SW11415	SW11515	SW12920	SW11420		
6,350	3,18	0,10	2,80	0,10	1,00	0,01	0,08									12,71	12,71							12,71				12,71		
6,350	3,18	0,20	2,80	0,10	1,50	0,02	0,12									12,71	12,71							12,71				12,71		
6,350	3,18	0,40	2,80	0,30	2,50	0,08	0,25									12,71	12,71							12,71				12,71		

								1	2	3	4	5	6	7	8	9	10	17	18	19	20	21	22	23	24	25	26	27
6,350	3,18	0,10	2,80	0,05	3,00	0,02	0,06																					13,15
6,350	3,18	0,20	2,80	0,05	3,00	0,05	0,12																					13,15
6,350	3,18	0,40	2,80	0,05	3,00	0,10	0,25																					13,15
6,350	3,18	0,80	2,80	0,05	3,00	0,15	0,45																					13,15
7,940	3,18	0,20	3,40	0,10	4,00	0,05	0,12																					13,71
7,940	3,18	0,40	3,40	0,10	4,00	0,10	0,25																					13,71
9,525	4,76	0,20	4,40	0,10	5,00	0,05	0,12																					13,71
9,525	4,76	0,40	4,40	0,10	5,00	0,10	0,25																					13,71
9,525	4,76	0,80	4,40	0,10	5,00	0,15	0,45																					13,71
9,525	4,76	1,20	4,40	0,10	5,00	0,15	0,60																					13,71
12,700	5,56	3,00	5,50	0,10	7,00	0,15	1,60																					22,94

Die neuen Qualitäten SW33... sind erst vollständig verfügbar wenn die Auslaufmodelle SW22... nicht mehr lagerhaltig sind.  
 Die new Grades SW33... are only fully available when the discontinued models SW22... are no longer in stock

VCMT

▲ empfohlene Qualität (auf Lager) recommended grade (on stock) ● alternative Qualität (auf Lager) alternative grade (on stock) ■ auf Lager bis ausverkauft Stock available until sold out

Bestellcode Ordering Code	Qualität   Grades																										
	P						M						K		N			S									
	SW33105	SW22115	SW33115	SW22125	SW33125	SW22740	SW33740	SW12910	SW44115	SW12920	SW22120	SW44125	SW11425	SW22135	SW44740	SW11440	SW22705	SW22320	SW11610	SW00610	SW00910	SW12910	SW22410	SW11415	SW11515	SW12920	SW11420

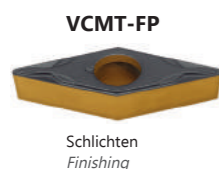

	1	2	3	4	5	6	7	8	9	10	11	12	13	14	15	16	17	18	19	20	21	22	23	24	25	26	27
VCMT 110302-FP					▲																						
VCMT 110304-FP		▲		▲	●																						
VCMT 160402-FP					▲																						
VCMT 160404-FP		▲		▲	●																						
VCMT 160408-FP		▲		▲	●																						
VCMT 160412-FP		▲																									



	1	2	3	4	5	6	7	8	9	10	11	12	13	14	15	16	17	18	19	20	21	22	23	24	25	26	27
VCMT 110302-FM										●		▲														▲	
VCMT 110304-FM										●		▲														▲	
VCMT 160402-FM										●		▲														▲	
VCMT 160404-FM										●		▲														▲	
VCMT 160408-FM										●		▲														▲	
VCMT 160412-FM										●		▲														▲	



	1	2	3	4	5	6	7	8	9	10	11	12	13	14	15	16	17	18	19	20	21	22	23	24	25	26	27
VCMT 110304-FK																		▲									
VCMT 160402-FK																		▲									
VCMT 160404-FK																		▲									
VCMT 160408-FK																		▲									



	1	2	3	4	5	6	7	8	9	10	11	12	13	14	15	16	17	18	19	20	21	22	23	24	25	26	27
VCMT 110304-MP		▲	●	▲	▲																						
VCMT 110308-MP		▲	●	▲	▲																						
VCMT 160404-MP		▲	●	▲	▲																						
VCMT 160408-MP		▲	●	▲	▲																						
VCMT 160412-MP		▲	●	▲	▲																						

Ersetzt alte Qualität in neue Qualität. SW22115 wird durch SW33115 ersetzt. SW22125 wird durch SW33125 ersetzt. SW22740 wird durch SW33740 ersetzt.  
 Replaces old grade into new grade. SW22115 replaces SW33115. SW22125 replaces SW33125. SW22740 replaces SW33740.

Wettbewerbs-Qualitätsvergleich siehe Seite 150-152. Competitor grade comparison see pages 150-152. →  
 Wettbewerbs-Spanbrechervergleich siehe Seite 154-157. Competitor chipbreaker comparison see pages 154-157. →

VCMT

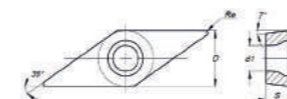

Maße Dimensions (mm)		Schnittdaten Cutting Details				Preis in €   Price in €																										
D	S	Re	d1	ap min	ap max	fn min	fn max	SW33105	SW22115	SW33115	SW22125	SW33125	SW22740	SW33740	SW12910	SW44115	SW12920	SW22120	SW44125	SW11425	SW22135	SW44740	SW11440	SW22705	SW11415	SW11515	SW12920	SW11420				
6,350	3,18	0,20	2,80	0,07	1,50	0,03	0,13					9,14	10,55																			
6,350	3,18	0,40	2,80	0,10	1,50	0,05	0,20		9,14	10,55	9,14	10,55																				
9,525	4,76	0,20	4,40	0,07	1,80	0,04	0,14					11,63	13,52																			
9,525	4,76	0,40	4,40	0,10	1,80	0,05	0,20		11,63	13,52	11,63	13,52																				
9,525	4,76	0,80	4,40	0,14	1,80	0,07	0,27		11,63	13,52	11,63	13,52																				
9,525	4,76	1,20	4,40	0,14	1,80	0,09	0,32		11,63	13,52																						

Maße Dimensions (mm)		Schnittdaten Cutting Details				Preis in €   Price in €																										
D	S	Re	d1	ap min	ap max	fn min	fn max	SW33105	SW22115	SW33115	SW22125	SW33125	SW22740	SW33740	SW12910	SW44115	SW12920	SW22120	SW44125	SW11425	SW22135	SW44740	SW11440	SW22705	SW11415	SW11515	SW12920	SW11420				
6,350	3,18	0,20	2,80	0,07	1,50	0,03	0,13											9,14		9,14								9,14				
6,350	3,18	0,40	2,80	0,10	1,50	0,05	0,20											9,14		9,14								9,14				
9,525	4,76	0,20	4,40	0,07	1,80	0,04	0,14											11,63		11,63								11,63				
9,525	4,76	0,40	4,40	0,10	1,80	0,05	0,20											11,63		11,63								11,63				
9,525	4,76	0,80	4,40	0,14	1,80	0,07	0,27											11,63		11,63								11,63				
9,525	4,76	1,20	4,40	0,14	1,80	0,09	0,32											11,63		11,63								11,63				

Maße Dimensions (mm)		Schnittdaten Cutting Details				Preis in €   Price in €																										
D	S	Re	d1	ap min	ap max	fn min	fn max	SW33105	SW22115	SW33115	SW22125	SW33125	SW22740	SW33740	SW12910	SW44115	SW12920	SW22120	SW44125	SW11425	SW22135	SW44740	SW11440	SW22705	SW11415	SW11515	SW12920	SW11420				
6,350	3,18	0,40	2,80	0,10	1,50	0,05	0,20																					9,14				
9,525	4,76	0,20	4,40	0,07	1,80	0,04	0,14																					11,63				
9,525	4,76	0,40	4,40	0,10	1,80	0,05	0,20																					11,63				
9,525	4,76	0,80	4,40	0,14	1,80	0,07	0,27																					11,63				

Maße Dimensions (mm)		Schnittdaten Cutting Details				Preis in €   Price in €																										
D	S	Re	d1	ap min	ap max	fn min	fn max	SW33105	SW22115	SW33115	SW22125	SW33125	SW22740	SW33740	SW12910	SW44115	SW12920	SW22120	SW44125	SW11425	SW22135	SW44740	SW11440	SW22705	SW11415	SW11515	SW12920	SW11420				
6,350	3,18	0,40	2,80	0,31	2,55	0,10	0,25			9,14	10,55	9,14	10,55																			
6,350	3,18	0,80	2,80	0,61	2,55	0,13	0,33			9,14	10,55	9,14	10,55																			
9,525	4,76	0,40	4,40	0,23	2,70	0,07	0,20			11,63	13,52	11,63	13,52																			
9,525	4,76	0,80	4,40	0,45	2,70	0,09	0,27			11,63	13,52	11,63	13,52																			
9,525	4,76	1,20	4,40	0,54	2,70	0,11	0,32			11,63	13,52	11,63	13,52																			

Die neuen Qualitäten SW33... sind erst vollständig verfügbar wenn die Auslaufmodelle SW22... nicht mehr lagerhaltig sind.  
 Die new Grades SW33... are only fully available when the discontinued models SW22... are no longer in stock



# 3

## INFORMATIONEN ZU SCHNITTDATEN

### CUTTING DATA INFORMATION

Hinweise zur individuellen Schnittdatenberechnung und zu Schnittgeschwindigkeiten für verschiedene Werkstoffarten.

*Notices concerning individual cutting data calculation and cutting speeds on different material types.*

**Ermittlung von Drehzahl und Schnittgeschwindigkeit**

Die Berechnung der Drehzahl n eines Werkzeugs mit Hilfe des Werkzeugdurchmessers d und der gewählten Schnittgeschwindigkeit Vc kann auf zwei Wegen erfolgen:

- Rechnerisch mit Hilfe einer Formel oder
- grafisch anhand des Drehzahldiagramms.

Drehzahldiagramme enthalten die an der Maschine einstellbaren Lastdrehzahlen in geometrischer Abstufung. Bei stufenlosen Antrieben kann die ermittelte Drehzahl genau eingestellt werden.

**Formel zur Berechnung der Drehzahl n:**

$$n = \frac{V_c \times 1000}{d \times \pi}$$

**Formeln zu Berechnung von Gesamtvorschub Vf und Schnittgeschwindigkeit Vc:**

$$V_f = f_z \times n \times z \quad V_c = \frac{d \times \pi \times n}{1000}$$

**Determination of rotation speed and cutting speed**

There are two ways to calculate a tool's rotation speed n based on the tool diameter d and the chosen cutting speed Vc:

- Calculation by using a formula or
- graphical approach with the help of a speed diagram.

Speed diagrams show the load speeds that can be set on the machine in geometric steps. When working with stepless drives, the determined rotation speed can be set exactly.

**Formula for calculating rotation speed n:**

$$n = \frac{V_c \times 1000}{d \times \pi}$$

**Formulas for calculating total feed Vf and cutting speed Vc:**

$$V_f = f_z \times n \times z \quad V_c = \frac{d \times \pi \times n}{1000}$$

**Drehzahldiagramm mit logarithmisch geteilten Koordinaten:  
Speed diagram with logarithmically divided coordinates:**

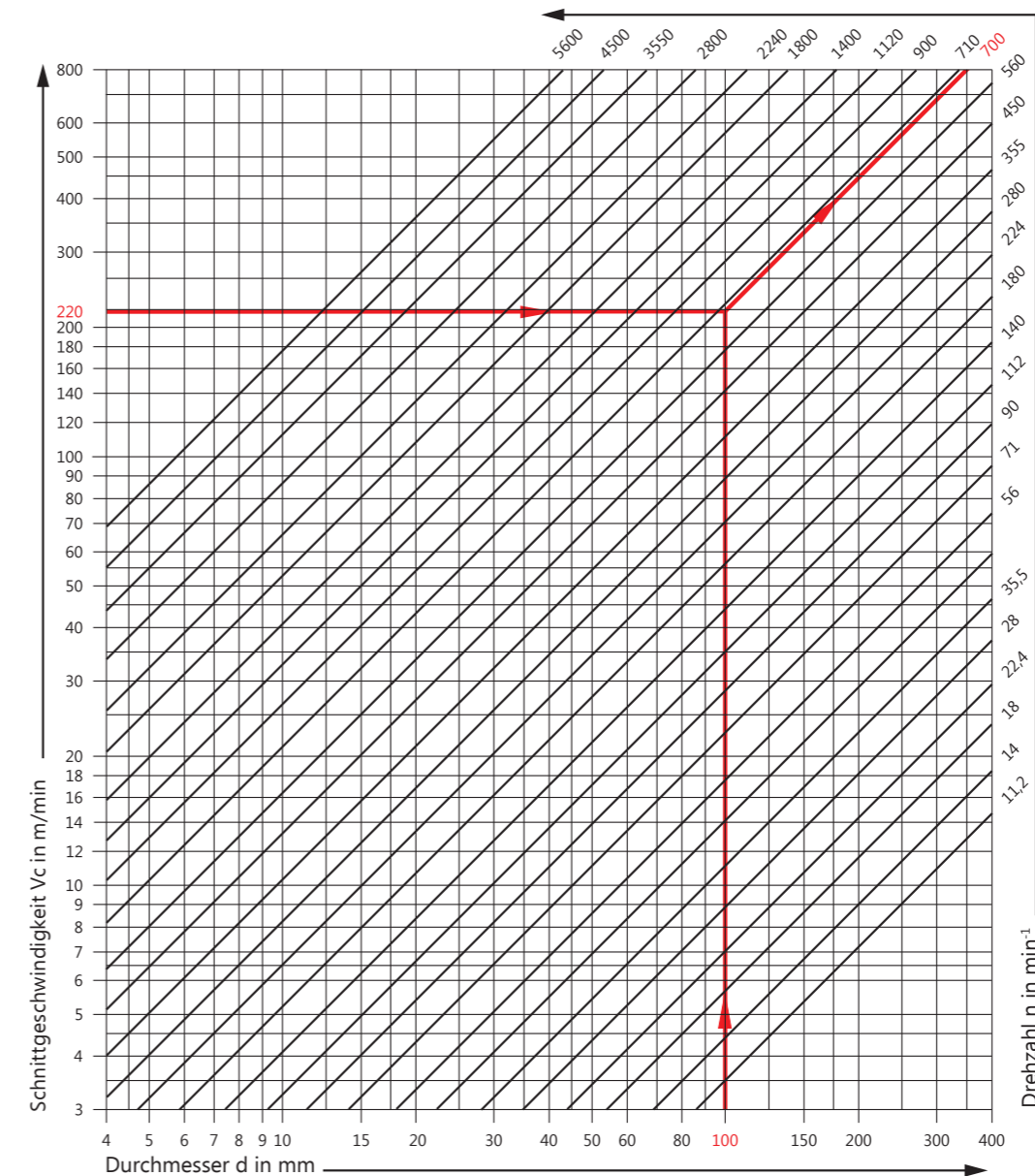

Quelle: Fischer, U., Gomeringer, R., Heinzler, M., Kilgus, R., Näher, F., Oesterle, S., Paetzold, H. & Stephan, A. (2005). Tabellenbuch Metall. Europa-Fachbuchreihe für Metallberufe (43., neu bearbeitete und erweiterte Auflage), S. 260. Haan-Gruiten: Verlag Europa Lehrmittel.

**Beispiel:**

**Example:**

$$d = 100 \text{ mm} \quad V_c = 220 \frac{\text{m}}{\text{min}} \quad n = ?$$

**Berechnung:**

**Calculation:**

$$n = \frac{V_c}{\pi \times d} = \frac{220 \frac{\text{m}}{\text{min}}}{\pi \times 0,1 \text{ m}} = 700,3 \frac{1}{\text{min}}$$

**Abgelesen aus dem Drehzahldiagramm:**

**Read from the speed diagram:**

$$n \approx 700 \frac{1}{\text{min}}$$



ISO	Material Material	fn (mm/rot) ▶ HB (Brinell) ▼	CVD-Beschichtung CVD Coating								
			Verschleißfestigkeit Wear Resistance						Zähigkeit Toughness		
			SW33105			SW22115			SW33115		
			0.2	0.4	0.8	0.2	0.4	0.8	0.2	0.4	0.8
P	Unlegierter Stahl Unalloyed Steel	125-170	280-380	210-300	200-250	250-350	180-270	170-220	200-350	180-270	170-220
	Niedrig legierter Stahl Low-alloyed Steel	180-350	220-280	200-260	170-210	190-250	170-230	140-180	190-250	170-230	140-180
	Hochlegierter Stahl High-alloyed Steel	200-325	165-250	150-235	140-230	135-220	120-205	110-200	135-220	120-205	110-200

Material Material	fn (mm/rot) ▶ HB (Brinell) ▼	CVD-Beschichtung CVD Coating									
		Verschleißfestigkeit Wear Resistance						Zähigkeit Toughness			
		SW22125			SW33125			SW22740			
			0.2	0.4	0.8	0.2	0.4	0.8	0.2	0.4	0.8
Unlegierter Stahl Unalloyed Steel	125-170	200-295	170-240	150-215	200-295	170-240	150-215	135-230	120-210	115-200	
Niedrig legierter Stahl Low-alloyed Steel	180-350	170-230	140-210	120-190	170-230	140-210	120-190	125-205	105-185	95-185	
Hochlegierter Stahl High-alloyed Steel	200-325	125-215	110-185	100-170	125-215	110-185	100-170	105-205	75-175	50-135	

Material Material	fn (mm/rot) ▶ HB (Brinell) ▼	CVD-Beschichtung CVD Coating		
		Verschleißfestigkeit Wear Resistance		
		Zähigkeit Toughness		
		SW33740		
		0.2	0.4	0.8
Unlegierter Stahl Unalloyed Steel	125-170	135-230	120-210	115-200
Niedrig legierter Stahl Low-alloyed Steel	180-350	125-205	105-185	95-185
Hochlegierter Stahl High-alloyed Steel	200-325	105-205	75-175	50-135

ISO	Material Material	fn (mm/rot) ▶ HB (Brinell) ▼	CVD-Beschichtung CVD Coating								
			Verschleißfestigkeit Wear Resistance						Zähigkeit Toughness		
			SW44115			SW22120			SW44125		
			0.2	0.4	0.6	0.2	0.4	0.6	0.2	0.4	0.6
M	Rostfreier Stahl, ferritisch/martensitisch Stainless Steel, ferritic/martensitic	200-330	125-260	100-220	80-200	130-200	80-170	60-150	100-230	70-175	50-135
	Rostfreier Stahl austenitisch Stainless Steel austenitic	180-330	130-290	100-240	80-190	130-200	80-170	60-150	100-240	70-175	55-130
	Rostfreier Stahl austenitisch-ferritisch (Duplex) Stainless Steel austenitic-ferritic (Duplex)	230-260	190-220	150-185	120-145	100-180	60-150	30-100	150-190	120-150	90-110

Material Material	fn (mm/rot) ▶ HB (Brinell) ▼	CVD-Beschichtung CVD Coating					
		Verschleißfestigkeit Wear Resistance					
		Zähigkeit Toughness					
		SW22135			SW44740		
		0.2	0.4	0.6	0.2	0.4	0.6
Rostfreier Stahl, ferritisch/martensitisch Stainless Steel, ferritic/martensitic	200-330	120-190	70-160	50-140	85-180	65-160	45-135
Rostfreier Stahl austenitisch Stainless Steel austenitic	180-330	120-190	70-160	50-140	85-170	65-145	45-125
Rostfreier Stahl austenitisch-ferritisch (Duplex) Stainless Steel austenitic-ferritic (Duplex)	230-260	90-170	50-140	30-90	130-160	110-135	85-105

ISO	Material Material	fn (mm/rot) ▶ HB (Brinell) ▼	PVD-Beschichtung PVD Coating					
			SW12910			SW12920		
			0.2	0.4	0.6	0.2	0.4	0.6
M	Rostfreier Stahl, ferritisch/martensitisch Stainless Steel, ferritic/martensitic	200-330	150-235	145-210	130-200	140-220	130-200	120-190
	Rostfreier Stahl austenitisch Stainless Steel austenitic	180-330	170-245	155-225	140-210	155-230	140-215	125-200
	Rostfreier Stahl austenitisch-ferritisch (Duplex) Stainless Steel austenitic-ferritic (Duplex)	230-260	130-200	125-195	120-180	125-195	120-185	115-165

ISO	Material Material	fn (mm/rot) ▶ HB (Brinell) ▼	PVD-Beschichtung PVD Coating					
			SW11425			SW11440		
			0.2	0.4	0.6	0.2	0.4	0.6
M	Rostfreier Stahl, ferritisch/martensitisch Stainless Steel, ferritic/martensitic	200-330	120-190	70-160	50-140	100-170	50-140	30-120
	Rostfreier Stahl austenitisch Stainless Steel austenitic	180-330	120-190	70-160	50-140	100-170	50-140	30-120
	Rostfreier Stahl austenitisch-ferritisch (Duplex) Stainless Steel austenitic-ferritic (Duplex)	230-260	90-170	50-140	30-90	70-150	30-120	20-80

ISO	Material Material	fn (mm/rot) ▶ HB ▼	CVD-Beschichtung CVD Coating		
			SW22410		
			0.2	-	-
S	Titaniumlegierungen Titanium Alloys (400< $\sigma_r$ <1050[MPa])	150-450	30-70	-	-

ISO	Material Material	fn (mm/rot) ▶ HB (Brinell) ▼	CVD-Beschichtung CVD Coating								
			SW22705			SW22320			SW22740		
			0.2	0.4	0.6	0.2	0.4	0.6	0.2	0.4	0.6
K	Verformbares Gusseisen Malleable Cast Iron	130-230	160-360	140-280	120-235	150-330	130-240	110-220	110-230	100-215	100-190
	Grauguss Grey Cast Iron	180-220	220-380	190-330	150-290	200-330	170-280	150-230	150-230	140-220	110-210
	Gusseisen mit Kugelgraphit Nodular Cast Iron	160-380	150-280	135-265	120-220	140-250	125-230	110-220	125-220	115-205	105-185

ISO	Material Material	fn (mm/rot) ▶ HB ▼	Unbeschichtet Uncoated			
			SW00610		SW00910	
			0.15	0.8	0.15	0.8
N	Aluminium-Knetlegierungen Aluminum Wrought Alloys	60-130	160-2400	60-320	375-2400	40-240
	Kupfer & Kupferlegierungen/ Bronze/Messing Copper/Copper Alloys	90-110	200-1000	120-520	375-630	35-65

ISO	Material Material	fn (mm/rot) ▶ HB ▼	PVD-Beschichtung PVD Coating	
			SW11610	
			0.15	0.8
N	Aluminium-Knetlegierungen Aluminum Wrought Alloys	60-130	100-2500	100-2500
	Kupfer & Kupferlegierungen/ Bronze/Messing Copper/Copper Alloys	90-110	100-1000	100-1000

ISO	Material Material	fn (mm/rot) ▶ HB (Brinell) ▼	PVD-Beschichtung PVD Coating								
			Verschleißfestigkeit Wear Resistance						Zähigkeit Toughness		
			SW12910			SW11415			SW11515		
			0.1	0.3	0.5	0.1	0.3	0.5	0.1	0.3	0.5
S	Hitzebeständige Superlegierungen (Eisenbasis) Heat Resistant Super-Alloys (Iron Base)	200-280	75-130	65-125	55-115	50-110	40-100	30-80	50-110	40-100	30-80
	Hitzebeständige Superlegierungen (Nickelbasis) Heat Resistant Super-Alloys (Nickel Base)	250-320	55-95	40-90	35-85	35-90	30-85	20-60	35-90	30-85	20-60
	Hitzebeständige Superlegierungen (Kobaltbasis) Heat Resistant Super-Alloys (Cobalt Base)	200-320	55-95	40-90	35-85	35-90	30-85	20-60	35-90	30-85	20-60
	Titaniumlegierungen Titanium Alloys (400< $\sigma$ <1050[MPa])	–	80-170	70-160	65-150	25-70	20-60	10-40	25-70	20-60	10-40

ISO	Material Material	fn (mm/rot) ▶ HB (Brinell) ▼	PVD-Beschichtung PVD Coating								
			Verschleißfestigkeit Wear Resistance						Zähigkeit Toughness		
			SW12920			SW11420			SW11440		
			0.1	0.3	0.5	0.1	0.3	0.5	0.1	0.3	0.5
S	Hitzebeständige Superlegierungen (Eisenbasis) Heat Resistant Super-Alloys (Iron Base)	200-280	70-120	55-115	50-110	50-110	40-100	30-80	30-90	25-80	20-60
	Hitzebeständige Superlegierungen (Nickelbasis) Heat Resistant Super-Alloys (Nickel Base)	250-320	35-80	27-75	23-70	35-90	30-85	20-60	25-70	20-60	10-50
	Hitzebeständige Superlegierungen (Kobaltbasis) Heat Resistant Super-Alloys (Cobalt Base)	200-320	35-80	27-75	23-70	35-90	30-85	20-60	25-70	20-60	10-50
	Titaniumlegierungen Titanium Alloys (400< $\sigma$ <1050[MPa])	–	65-150	50-140	45-130	25-70	20-60	10-40	15-50	10-50	5-35

# 4

## WETTBEWERBSVERGLEICH *COMPETITOR COMPARISON*

Vergleich der Beschichtungen und Spanbrecher mit Produkten der Wettbewerber.

*Comparison of grades and chip breakers with products of competitors.*

CVD-Beschichtungen CVD Coatings

ISO	P				
	P01	P10	P20	P30	P40
SCHWARZ	SW33105	SW22115 SW33115	SW22115 SW33115 SW22125 SW33125	SW22125 SW33125	SW22740 SW33740
SANDVIK	GC4205 GC4005	GC4315, GC4215 GC4015, GC4325	GC4315, GC4215 GC4015, GC4325 GC4225, GC4025	GC4325, GC4225 GC4025, GC4235 GC4035	GC4235 GC4035
KENNAMETAL	KCP05 KC9105	KCP10B, KCP10 KCP25, KC9110	KCP25B, KCP25 KC9125, KC9125	KCP30 KCP40 KCP8050	KCP30, KCP40 KC9140, KC9040 KC9240, KC9245
ISCAR	IC9150 IC8150 IC428	IC9150, IC9015 IC8150, IC8250	IC9015, IC8250 IC9050, IC9250 IC8350	IC8350 IC9250 IC9350	IC9350
SECO	TP0500 TP1500	TP1500 TP2500	TP2500	TP3500 TP3000	TP3500 TP3000
MITSUBISHI	UE6105	UE6105, MC6015 UE6110, MY5015	MC6015, UE6110 MC6025, UE6020 MY5015	MC025, UE6020 UE6035, UH6400	UE6035 UH6400
SUMITOMO	AC810P AC700G	AC810P AC700G AC820P AC2000	AC820P AC2000 AC830P	AC830P AC630M	AC630M
TUNGALOY	T9105 T9005	T9105 T9005 T9115	T9115 T9125	T9125 T9135 T9035	T9135 T9035
WALTER	WPP01	WPP01 WPP05	WPP10S WPP20S	WPP30S	
KYOCERA	CA510 CA5505	CAS510 CA5505 CA515 CA5515	CA515, CA5515 CA525, CA5525 CR9025	CA525, CA5525 CA530, CA5335 CR9025	CA530 CA5535
TAEGUTEC	TT1300	TT1300 TT7310 TT7400	TT3500, TT5100 TT7400, KT7300 TT7800	TT3500 TT5100 TT7400 KT7300	TT5100 TT7100 KT7300 TT7800
KORLOY	NC3010	NC3215	NC3220 NC3220 NC3120	NC3215 NC3225 NC3120	NC500H NC5330
WIDIA	TN7005	TN7010 TN7015 TN2510	TN7010 TN7015 TN2510	TN7025 TN7035 TN450 TN7435 TN7535	TN77035 TN450 TN7435 TN7535
CERATIZIT		CTC1110 CTC1115 CTC3110 TCC410	CTC1110 CTC1115 CTC1125 CTC1130 CTC1425	CTC1125 CTC1130 CTC1135 CTC1425	CTC1135 CTC1435 CTC2135

M				K			
M10	M20	M30	M40	K01	K10	K20	K30
SW44115	SW44115 SW44125	SW44125 SW44740	SW44740	SW22705	SW22705 SW22320	SW22320	SW22740
GC2015	GC2015	GC2025	GC2025	GC3205 GC3210	GC3205 GC3210 GC3215	GC3215	
KCM15	KCM15 KC9225	KCM25 KC9230	KCM35 KC9240 KC9245	KCK05	KCK15B, KCK15B KC920, KC9315	KCK20 KC9110 KC9325	KC9125 KC9325
IC9250 IC6015 IC8250	IC9250, IC6015 IC9025, IC656	IC9350 IC6025 IC635	IC6025 IC9350	IC5005 IC9007	IC5005, IC5010 IC9150, IC428 IC4028	IC5010, IC8150 IC9150, IC9015 IC418	IC9015 IC418
TM2000	TM2000	TM4000	TM4000	TH1500, TK1001 TK1000	TK1001, TK1000 TK2000, TK2001	TK2001 TK2000	
MC7015 US7020	MC7015 US7020 MC7025	MC7025 US735	US735	MC5005 UC5105	MC5015 UC5115 MY5015	MC5015, UC5115 UE6110, MY5015	UE6110
AC610M	AC610M AC6030M AC630M	AC6030M AC630M	AC6030M AC630M	AC405K AC410K	AC405K AC410K AC415K AC420K AC700G AC820P	AC415K AC420K AC700G AC820P	AC820P
T9115	T6020 T9125	T6030		T5105	T5115	T5115 T5125	T5125
WAM20				WAK10	WAK20	WAK30	
CA6515	CA6515 CA6525	CA6525		CA4505 CA4010	CA4515 CA4110 CA4115	CA4515 CA4115 CA4120	
	TT5100	TT5100 TT7100	TT7100		TT3100 TT7310 TT8115	TT7310 TT8115	
NC9020	NC9020	NC9025	NC9025		NC6205 NC6210 NC6215	NC6215	
TN7525	TN7025 TN8025 TN7525 TN7535	TN8025, TN450 TN7435 TN7525 TN7535	TN450 TN7435	TN5505	TN5015 TN2510 TN5415 TN5505 TN5515	TN5015 TN5020 TN5415 TN5515 TN5520	TN7435
CTC1110 CTC1115	CTC1115, CTC1125, CTC1130, CTC1135	CTC1125, CTC1135, CTC1425, CTC1435, CTC2135	CTC2135		CTC1110 CTC1115 CTC3110 CTC410 CTC3215	CTC1115 CTC1125 CTC1130 CTC1425 CTC3215	TSC30

Die Tabelle dient als Orientierungshilfe. Die Inhalte wurden von den genannten Unternehmen nicht bestätigt.  
This table is for guidance only. The content has not been confirmed by the mentioned companies.



PVD-Beschichtungen PVD Coatings

ISO	M					S			
	M01	M10	M20	M30	M40	S01	S10	S20	S30
SCHWARZ	SW12910	SW12910	SW12920 SW11425	SW11425 SW12920	SW11440	SW12910 SW11515	SW12910 SW11420 SW11515 SW11420	SW11420 SW12920 SW11415 SW11515	SW11440
SANDVIK	GC1005	GC1005 GC1025 GC1125 GC1105		GC1125 GC2035	GC2035		GC1105 GC1005 GC1025	GC1025 GC1125	GC1125
KENNAMETAL		KC5010 KC5510 KC6005 KC6015	KC5025 KC5525 KC7020 KC7020	KC7030 KC7225			KC5010 KC5410 KC5510	KC5025 KC5525	
ISCAR	IC520	IC330, IC354 IC507, IC520 IC570, IC807 IC907, IC3028	IC250, IC330 IC354, IC808 IC908, IC1008 IC1028, IC3028	IC228, IC250 IC328, IC330 IC100 IC1028 IC3028	IC328 IC928 IC1008 IC102 IC3028	IC507 IC907	IC507 IC903	IC300, IC808 IC908, IC928 IC3028 IC806	
SECO	TS2000 CP200	CP200 TS2000	CP250 TS2500 CP500	CP500			CP200 CP250 TS2000 TS2500	CP250 TS2500 CP500	
MITSUBISHI	VP10MF		VP10RT VP20RT VP15TF VP20MF	VP10RT VP20RT VP15TF VP20MF MP7035	MP7035	MP9005 VP05RT	MP9005 MP9015 VP10RT	MP9015 MT9015 VP20RT	VP15TF
SUMITOMO			AC520U	AC520U AC530U	AC530U		AC510U	AC510U AC520U	AC520U
TUNGALOY		AH710	AH710 AH725 AH120 SH730 GH730 GH130 GH330, AH60	GH330 AH725 AH120 AH730 GH730 GH130 J740, AH645	J740	AH905	AH905 SH730 AH110 AH120	AH120 AH720	AH725
WALTER	WSM10	WSM20	WSM30			WDSM10	WSM20	WSM30	
KYOCERA	PR915	PR915 PR1025 PR1225 PR1425	PR1025 PR1125 PR1225 PR915 PR930	PR1125		PR915	PR915	PR1125	
TAEGUTEC	TT5080	TT5030 PV3010 PV3030 TT9030	TT5030 PV3030 TT9020 TT9030	TT9030 TT9080 TT8030	TT8010 TT8020 TT8030		TT5030	TT5030 TT8020 TT8030	TT8020
KORLOY		PC8110 PC9030	PC9030 PC8110 PC8115	PC9030	PC5400	PC8110	PC8110 PC8115	PC8105 PC8815 PC5300	PC5400
WIDIA	TN6010		TN6415 TN6435 TN6525	TN6435 TN6525	TN6540		TN6010	TN6010	TN6025
CERATIZIT			CTP2120 CTP1235 SR226 GM127	CTP2240 CTP1235 CTP2235 SR226 GM127	CM40 CM45 CTP2440		CM40 SR226	CM45 CTP2440 GM127	CTP2135

Die Tabelle dient als Orientierungshilfe. Die Inhalte wurden von den genannten Unternehmen nicht bestätigt.  
 This table is for guidance only. The content has not been confirmed by the mentioned companies.

Negative Spanbrecher Negative Chipbreaker

ISO	P						M		
Anwendungsbereich Application	Finishing	Medium to Finishing	Medium Wiper	Medium to Roughing	Roughing	Heavy Roughing	Finishing	Medium	Roughing
SCHWARZ	MF	MF, LC	MW	PM, MR	HR, RP	RP, HY, HZ	MF, SF, SFSM	MS, SF	SS, SSM, SMR
SANDVIK	QF	PF, QF, LC, MF, R/L-K	WL, WF, WMX, WM, WR	PM, QM, XM, XRM	HM, PR, MR	PR, MR HR, QR	MF, XF LC, R/L-K	MM, QM, XM, XRM	MR, HM, PR
KENNAMETAL	FS, LF	FF, FN	FW, MW, RW	P, MN	RN, RP, MR	RM, RH	FP	MP, P	UP, RP
ISCAR	SF, PP, TF	F3P, NF, SF	WF, WG	M3P, M3M, PP, TF, GN	NR, MR	R3P, NM	TF, VL	M3M, PP	MR, MH
Tungaloy	01, TF	TS, TSF, ZF 11, NS, AS, TQ, NM, CB, C	AFW, FW, ASW, SW	TM, AM, DM, ZM, All-round	TH, THS	TU, TRS, TUS	SF, SA, SS	SM, S	TH, SH, TU
MITSUBISHI	PK, FH	SA, FY, C, SH, MP	SW	MA, MH, MP	RP, GH, HZ, HL	HM, HX, HV	GM, MS, SH, LM	MM, MA, ES	GH, RM, HZ
SUMITOMO	FA	SU, FL, SE, SX	LUW, SEW, GUW	GU, GE, UX	MU, ME, HG	HG, HP HU, HW, HF	EX, EG, SU, EF	GU, HM	EM, MU
WALTER		NF3, NS6	NF, NM	NMT, NM4	NM5, NM6, NM9	NR6, NRF, NRR	NF4, NMS	NM4	NR4, NRT, NRS
KYOCERA	DP	PQ, VFCJ, PQ, GP, PP, HQ, GS, CQ	WP, WQ	HS, PT, GT, CS, PS	PH All-round	PX	GU, MQ	TK, MU	MS
TAEGUTEC	FA	FG, VF, EA, FC, MC, ML, MP	WS, WT	PC, MT MC, MG	RT	HT, HD RX, RH HY, HZ	EA, SF, SU, FG	EM, ET	
KORLOY	VF, HU	VL		VM	GR, HR	GH, VT	VP2	VP3, HS	GR, VM, VH, GH
WIDIA		4, AP	FW, MW	48	49				SR
CERATIZIT		CF, TF	TFQ, TMQ	TMF, TMM, M50	TM, TRM	TRR, TR, R28, R58, R88	CF, F30, M34, F32, TF	TMF, M42, M30, M52	TM, M60, TRM, TMR, TRR, R80

Die Tabelle dient als Orientierungshilfe. Die Inhalte wurden von den genannten Unternehmen nicht bestätigt.  
This table is for guidance only. The content has not been confirmed by the mentioned companies.

	K			N	S	
Medium to Finishing	Medium	Roughing to Heavy Roughing	Medium	Finishing	Medium	
ST	ST, HR, FLAT	HR, FLAT, HZ	MS	SF, MS, MSS, FSM	SS, MSR	
KF, XF	KM, QM, XM, XRM	KR Without chipbreaker	MF QM	SF 01	MM, QM, SMR	
FN	RP, UN	Without chipbreaker	MS, MP, MG	FS, LS, MS	UP, P, NGP, RP	
GN			PP		PP	
CF	CM All-round	CH Without chipbreaker	P	HRF	HRM, HMM, SA	
LK, MA	MK GK	RK Without chipbreaker		FJ, LS	MS, RS, GJ	
UZ	GZ	Without chipbreaker	AX	EF, EX	EG, MU	
	NM5	Without chipbreaker		NFT, NF4	NMS, NM4, NRS, NR4	
C	ZS All-round	GC Without chipbreaker	AH, A3	MQ	TK, MS, MU	
FG	MT, MG	RT	ML	SF	SU	
B25	FLAT	GR	HÁ	VP1	VP2, VP3	
					SM	
CF	M50	TMR, TR R28, R58, R88	F32		M34, M52	

Positive Spanbrecher Positive Chipbreaker

ISO	P					M		
Anwendungsbereich Application	Fine Finishing	Finishing	Finishing Wiper	Finishing to Medium	Finishing to Medium Wiper	Fine Finishing	Finishing	Finishing to Medium
SCHWARZ	FS	FS, FP	FW	MP	MW	FS	FS, FM, LM	SMS,MM, LM
SANDVIK	UM	R/L-K, PF, XF UF,	WF	PM	WM	UM	MF, UF, R/L-K	MM, XM
KENNAMETAL	UF	11, GM, LF	FW	MF, MP, GM, MR	MW	LF, GM	MF	MF, MP
ISCAR	SF	PF, SM, 14, 17, 19, XL	WF	DT, HQ	WG	SM	PF, 14	SM
Tungaloy	01	PSF, PF, SS, PS, PSS, TS	TSW, W08	PM, 23, 24, RS		PSF	SS, PSS	PM
MITSUBISHI	FV, SMG	FP, FV, SV, LP	SW	MP, MV	MW	FJ	FM, FV, SV	MM, MV
SUMITOMO	FC, FW	FP, FZ, LU, FK, SS, SC, SU, SK, SF	LUW, SDW	SU, UM, UJ		FC	SU	UM
WALTER	PF2	PF5, PF4, PS5	PF	PM5	PM	PF2	PF4	PM5
KYOCERA	CF, CK	CQ, GK, GP, HQ, XP, XQ		VF, MF		GQ, GF	MQ	XQ, VF
TAEGUTEC	FA	FG, GF		MT, PC	WT	FG	FA	MT, PC
KORLOY	HFP	VF, VL, F		HMP, C25, M.CMX		HFP	VF, F	HMP, C25, M
WIDIA	2	21, 41, 67		UM, MT		2	2, 41, 67	UM, MT
CERATIZIT	F32	SF, SMF, SMQ		SM			SF, SMF, SMQ	F23, F43, SM

K				N	S		
Finishing	Finishing Wiper	Finishing to Medium	Finishing to Medium Wiper	Medium	Fine Finishing	Finishing	Finishing to Medium
FK	FW	MK, FLAT	MW	LN, SAL, PL	FS	FM, MTS	MM, LM
KF	WF	KM, KR	WM	AL	UM	MF, UF, R/L-K	MM, XM
11	FW	FW	MW	HP, GT	LF	GM	MF
PF	PF	PM5, 19, FLAT		AF, AS	SM	PF, 14	SM
		CM, FLAT		AL, PP	PSF, PF, SS, PS, PSS, TS	PSF, PF, SS, PS, PSS, TS	PM
FV	SW	MV, MK, FLAT	MW	AZ, R/L-F	FJ	FV	MV
SK	LUW	UM, FLAT		AG, AX, AY	FC	FX, FY	SI
	PF	PM5, PSS	PM	PF2, PM2	PF2	PF4	PM5
GK		FLAT		AH, A3	GQ	MQ	MQ
FA	MT, PC	FALT	WT	FL		FA	FG
HMP		C25, HMP, FLAT		AK, AR	HFP	HFP	HMP
2, 41, 67		UM, MT, FLAT		AL1, AL2, AL3	2	41, 2	UM
SF		25P, 27, 29		23P, 25P, 27	SF	F23, F43, SM	SM, 25P 29

Die Tabelle dient als Orientierungshilfe. Die Inhalte wurden von den genannten Unternehmen nicht bestätigt.  
This table is for guidance only. The content has not been confirmed by the mentioned companies.



# 5

## RADSATZBEARBEITUNG RAILWAY



Mit unseren neuen Wendeschneidplatten stehen Ihnen ab sofort effiziente und produktive Bearbeitungslösungen für die Radsatzbearbeitung (Reprofilierung von Rädern) zur Verfügung.

*With our new range of inserts you will achieve efficient and productive machining solutions for the Railway industry (reprofiling of wheels).*



CNMM

▲ empfohlene Qualität (auf Lager) recommended grade (on stock) ● alternative Qualität (auf Lager) alternative grade (on stock) ■ Auslaufmodell (auf Lager bis ausverkauft) discontinued model (in stock until sold out)

Bestellcode Ordering Code	Qualität   Grades																								
	P						M								K	N	S								
	SW33105	SW22115	SW33115	SW22125	SW33125	SW22740	SW12910	SW44115	SW12920	SW22120	SW44125	SW11425	SW22135	SW44740	SW11440	SW22705	SW22320	SW00910	SW12910	SW22410	SW11415	SW11515	SW12920	SW11420	

CNMM-HY



Schwerzerspannung bis Schruppen  
Heavy to Roughing

	1	2	3	4	5	6	7	8	9	10	11	12	13	14	15	16	17	18	19	20	21	22	23	24	25
CNMM 190612-HY	■	●	■	▲	■																				
CNMM 190616-HY	■	●	■	▲	■																				
CNMM 190624-HY	■	●	■	▲	■																				
CNMM 250924-HY	■	●	■	▲	■																				

CNMM-HZ

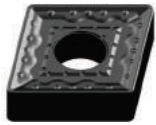

Schwerzerspannung bis Schruppen  
Heavy to Roughing

	1	2	3	4	5	6	7	8	9	10	11	12	13	14	15	16	17	18	19	20	21	22	23	24	25
CNMM 190612-HZ	■	●	■	▲	■	●																			
CNMM 190616-HZ	■	●	■	▲	■	●																			
CNMM 190624-HZ	■	●	■	▲	■	●																			
CNMM 250924-HZ	■	●	■	▲	■	●																			

SNMM

Bestellcode Ordering Code	Qualität   Grades																								
	P						M								K	N	S								
	SW33105	SW22115	SW33115	SW22125	SW33125	SW22740	SW12910	SW44115	SW12920	SW22120	SW44125	SW11425	SW22135	SW44740	SW11440	SW22705	SW22320	SW00910	SW12910	SW22410	SW11415	SW11515	SW12920	SW11420	

SNMM-HY



Schwerzerspannung bis Schruppen  
Heavy to Roughing

	1	2	3	4	5	6	7	8	9	10	11	12	13	14	15	16	17	18	19	20	21	22	23	24	25
SNMM 190612-HY	■	●	■	▲	■																				
SNMM 190616-HY	■	●	■	▲	■																				
SNMM 190624-HY	■	●	■	▲	■																				
SNMM 250724-HY	■	●	■	▲	■																				
SNMM 250924-HY	■	●	■	▲	■																				

SNMM-HZ



Schwerzerspannung bis Schruppen  
Heavy to Roughing

	1	2	3	4	5	6	7	8	9	10	11	12	13	14	15	16	17	18	19	20	21	22	23	24	25
SNMM 190612-HZ	■	●	■	▲	■	●																			
SNMM 190616-HZ	■	●	■	▲	■	●																			
SNMM 190624-HZ	■	●	■	▲	■	●																			
SNMM 250724-HZ	■	●	■	▲	■	●																			
SNMM 250732-HZ				■	▲																				
SNMM 250924-HZ	■	●	■	▲	■	●																			

CNMM

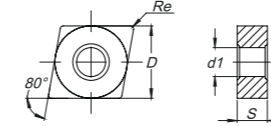

Maße Dimensions (mm)		Schnittdaten Cutting Details				Preis in €   Price in €																						
D	S	Re	d1	ap min	ap max	fn min	fn max	SW33105	SW22115	SW33115	SW22125	SW33125	SW22740	SW33740	SW12910	SW44115	SW12920	SW22120	SW44125	SW22705	SW22320	SW00910	SW12910	SW22410	SW11415	SW11515		
								1	2	3	4	5	6	7	8	9	10	11	12	17	18	19	20	21	22	23		
19,050	6,35	1,20	7,94	2,00	12,00	0,35	0,80	20,55	23,80	20,55	23,80	20,55																
19,050	6,35	1,60	7,94	2,00	12,00	0,35	1,00	20,55	23,80	20,55	23,80	20,55																
19,050	6,35	2,40	7,94	2,00	12,00	0,35	1,20	20,55	23,80	20,55	23,80	20,55																
25,400	9,52	2,40	9,12	2,50	15,00	0,40	1,40	42,73	49,22	42,73	49,22	42,73																

								1	2	3	4	5	6	7	8	9	10	11	12	17	18	19	20	21	22	23
19,050	6,35	1,20	7,94	2,40	12,00	0,50	0,80	20,55	23,80	20,55	23,80	20,55	23,80													
19,050	6,35	1,60	7,94	2,40	12,00	0,50	1,10	20,55	23,80	20,55	23,80	20,55	23,80													
19,050	6,35	2,40	7,94	3,20	12,00	0,60	1,60	20,55	23,80	20,55	23,80	20,55	23,80													
25,400	9,52	2,40	9,12	3,20	17,00	0,60	1,60	42,73	49,22	42,73	49,22	42,73	49,22													

SNMM

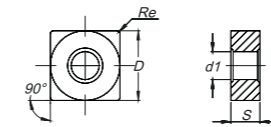

Maße Dimensions (mm)		Schnittdaten Cutting Details				Preis in €   Price in €																						
D	S	Re	d1	ap min	ap max	fn min	fn max	SW33105	SW22115	SW33115	SW22125	SW33125	SW22740	SW33740	SW12910	SW44115	SW12920	SW22120	SW44125	SW22705	SW22320	SW00910	SW12910	SW22410	SW11415	SW11515		
								1	2	3	4	5	6	7	8	9	10	11	12	17	18	19	20	21	22	23		
19,050	6,35	1,20	7,94	2,00	12,00	0,35	0,90	20,55	23,80	20,55	23,80	20,55																
19,050	6,35	1,60	7,94	2,00	12,00	0,35	1,20	20,55	23,80	20,55	23,80	20,55																
19,050	6,35	2,40	7,94	2,00	12,00	0,60	1,60	20,55	23,80	20,55	23,80	20,55																
25,400	7,94	2,40	9,12	2,50	15,00	0,60	1,60	39,21	45,16	39,21	45,16	39,21																
25,400	9,52	2,40	9,12	3,00	15,00	0,60	1,60	42,73	49,22	42,73	49,22	42,73																

								1	2	3	4	5	6	7	8	9	10	11	12	17	18	19	20	21	22	23
19,050	6,35	1,20	7,94	2,40	13,00	0,35	0,90	20,55	23,80	20,55	23,80	20,55	23,80													
19,050	6,35	1,60	7,94	2,40	13,00	0,35	1,20	20,55	23,80	20,55	23,80	20,55	23,80													
19,050	6,35	2,40	7,94	3,20	13,00	0,60	1,60	20,55	23,80	20,55	23,80	20,55	23,80													
25,400	7,94	2,40	9,12	3,20	17,00	0,60	1,60	39,21	45,16	39,21	45,16	39,21	45,16													
25,400	7,94	3,20	9,12	3,20	17,00	0,80	1,80				39,21	45,16														
25,400	9,52	2,40	9,12	3,20	17,00	0,60	1,60	42,73	49,22	42,73	49,22	42,73	49,22													



**LNUX**

▲ empfohlene Qualität (auf Lager) **●** alternative Qualität (auf Lager) ■ Auslaufmodell (auf Lager bis ausverkauft)  
*recommended grade (on stock) alternative grade (on stock) discontinued model (in stock until sold out)*

Bestellcode Ordering Code	Qualität   Grades																								
	P						M								K	N	S								
	SW33105	SW22115	SW33115	SW22125	SW33125	SW22740	SW33740	SW12910	SW44115	SW12920	SW22120	SW44125	SW11425	SW22135	SW44740	SW11440	SW22705	SW22320	SW00910	SW12910	SW22410	SW11415	SW11515	SW12920	SW11420
LNUX 321248-RMM	1	2	3	4	5	6	7	8	9	10	11	12	13	14	15	16	17	18	19	20	21	22	23	24	25



Mittlere Bearbeitung  
Medium

**LNUX-RRM**



Schwerzerspanung  
Heavy Roughing

**LNUX-RHR**



Schwerzerspanung  
Heavy Roughing

**LNUX-T**

Bestellcode Ordering Code	Qualität   Grades																								
	P						M								K	N	S								
	SW33105	SW22115	SW33115	SW22125	SW33125	SW22740	SW33740	SW12910	SW44115	SW12920	SW22120	SW44125	SW11425	SW22135	SW44740	SW11440	SW22705	SW22320	SW00910	SW12910	SW22410	SW11415	SW11515	SW12920	SW11420
LNUX 191940-RMM-T	1	2	3	4	5	6	7	8	9	10	11	12	13	14	15	16	17	18	19	20	21	22	23	24	25
LNUX 301940-RMM-T	1	2	3	4	5	6	7	8	9	10	11	12	13	14	15	16	17	18	19	20	21	22	23	24	25

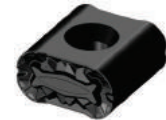

Mittlere Bearbeitung  
Medium

**LNUX-RRM-T**



Schruppen  
Roughing

**LNUX-RHR-T**



Schwerzerspanung  
Heavy Roughing

**LNUX**

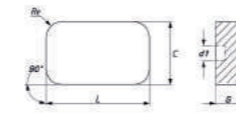

Maße Dimensions (mm)			Schnittdaten Cutting Details				Preis in €   Price in €																						
L	C	Re	S	d1	ap <sub>min</sub>	ap <sub>max</sub>	fn <sub>min</sub>	fn <sub>max</sub>	SW33105	SW22115	SW33115	SW22125	SW33125	SW22740	SW33740	SW44115	SW12920	SW22120	SW44125	SW22705	SW22320	SW00910	SW12910	SW22410	SW11415	SW11515			
31,75	19,05	4,76	12,7	7,87	1,50	18,00	0,30	1,50	1	2	3	4	5	6	7	9	10	11	12	17	18	19	20	21	22	23			
									61,39	70,85	61,39	70,85																	

31,75	19,05	4,76	12,7	7,87	1,50	18,00	0,80	1,50	1	2	3	4	5	6	7	9	10	11	12	17	18	19	20	21	22	23	
									61,39	70,85																	

31,75	19,05	4,76	12,7	7,87	1,50	18,00	0,50	1,80	1	2	3	4	5	6	7	9	10	11	12	17	18	19	20	21	22	23	
									61,39	70,85																	

**LNUX-T**

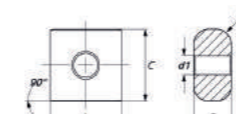

Maße Dimensions (mm)			Schnittdaten Cutting Details				Preis in €   Price in €																						
L	C	Re	S	d1	ap <sub>min</sub>	ap <sub>max</sub>	fn <sub>min</sub>	fn <sub>max</sub>	SW33105	SW22115	SW33115	SW22125	SW33125	SW22740	SW33740	SW44115	SW12920	SW22120	SW44125	SW22705	SW22320	SW00910	SW12910	SW22410	SW11415	SW11515			
19,05	19,05	4,00	10,00	6,35	1,60	8,00	0,30	1,50	1	2	3	4	5	6	7	9	10	11	12	17	18	19	20	21	22	23			
30,00	19,05	4,00	10,00	6,35	1,60	13,00	0,30	1,50	57,60	66,25	57,60	66,25																	

19,05	19,05	4,00	10,00	6,35	2,50	10,00	0,80	1,50	1	2	3	4	5	6	7	9	10	11	12	17	18	19	20	21	22	23
30,00	19,05	4,00	10,00	6,35	2,50	12,00	0,50	2,00	57,60	66,25	57,60	66,25														

19,05	19,05	4,00	10,00	6,35	2,50	10,00	0,50	1,80	1	2	3	4	5	6	7	9	10	11	12	17	18	19	20	21	22	23
30,00	19,05	4,00	10,00	6,35	3,00	15,00	0,50	1,80	57,60	66,25	57,60	66,25														

RCMR

▲ empfohlene Qualität (auf Lager) recommended grade (on stock) ● alternative Qualität (auf Lager) alternative grade (on stock) ■ Auslaufmodell (auf Lager bis ausverkauft) discontinued model (in stock until sold out)

RCMR-RR



Schruppen bis mittlere Bearbeitung  
Roughing to Medium

Bestellcode Ordering Code	Qualität   Grades																									
	P							M								K	N	S								
	SW33105	SW22115	SW33115	SW22125	SW33125	SW22740	SW33740	SW12910	SW44115	SW12920	SW22120	SW44125	SW11425	SW22135	SW44740	SW11440	SW22705	SW22320	SW00910	SW12910	SW22410	SW11415	SW11515	SW12920	SW11420	
	1	2	3	4	5	6	7	8	9	10	11	12	13	14	15	16	17	18	19	20	21	22	23	24	25	
RCMR 2507M0-RR		●		▲																						
RCMR 3209M0-RR		●		▲																						

RCMR

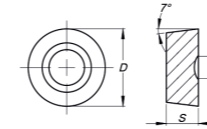

Maße Dimensions (mm)		Schnittdaten Cutting Details				Preis in €   Price in €																						
D	S	Re	d1	ap min	ap max	fn min	fn max	SW33105	SW22115	SW33115	SW22125	SW33125	SW22740	SW33740	SW44115	SW12920	SW22120	SW44125	SW22705	SW22320	SW00910	SW12910	SW22410	SW11415	SW11515			
								1	2	3	4	5	6	7	9	10	11	12	17	18	19	20	21	22	23			
25,00	7,94	-	9,00	3,20	8,00	0,80	2,50		33,26		33,26																	
32,00	9,52	-	12,00	3,20	13,00	0,80	2,50	59,76		59,76																		

RCMT/RCMX

RCMT-ST



Schruppen bis mittlere Bearbeitung  
Roughing to Medium

Bestellcode Ordering Code	Qualität   Grades																										
	P							M								K	N	S									
	SW33105	SW22115	SW33115	SW22125	SW33125	SW22740	SW33740	SW12910	SW44115	SW12920	SW22120	SW44125	SW11425	SW22135	SW44740	SW11440	SW22705	SW22320	SW00910	SW12910	SW22410	SW11415	SW11515	SW12920	SW11420		
	1	2	3	4	5	6	7	8	9	10	11	12	13	14	15	16	17	18	19	20	21	22	23	24	25		
RCMX 2006M0-ST					▲												▲										
RCMX 2507M0-ST		●		▲																							
RCMX 3009M0-ST			●	▲																							
RCMX 3209M0-ST		●		▲																							

RCMX-RM



Schruppen bis mittlere Bearbeitung  
Roughing to Medium

Bestellcode Ordering Code	Qualität   Grades																									
	P							M								K	N	S								
	SW33105	SW22115	SW33115	SW22125	SW33125	SW22740	SW33740	SW12910	SW44115	SW12920	SW22120	SW44125	SW11425	SW22135	SW44740	SW11440	SW22705	SW22320	SW00910	SW12910	SW22410	SW11415	SW11515	SW12920	SW11420	
	1	2	3	4	5	6	7	8	9	10	11	12	13	14	15	16	17	18	19	20	21	22	23	24	25	
RCMX 3209M0-RM		■	●	■	▲												▲	■								

RCMX-RR



Schruppen bis mittlere Bearbeitung  
Roughing to Medium

Bestellcode Ordering Code	Qualität   Grades																									
	P							M								K	N	S								
	SW33105	SW22115	SW33115	SW22125	SW33125	SW22740	SW33740	SW12910	SW44115	SW12920	SW22120	SW44125	SW11425	SW22135	SW44740	SW11440	SW22705	SW22320	SW00910	SW12910	SW22410	SW11415	SW11515	SW12920	SW11420	
	1	2	3	4	5	6	7	8	9	10	11	12	13	14	15	16	17	18	19	20	21	22	23	24	25	
RCMX 2507M0-RR		■	●	■	▲																					
RCMX 3209M0-RR		■	●	■	▲		●																			

RCMT/RCMX

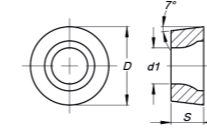

Maße Dimensions (mm)		Schnittdaten Cutting Details				Preis in €   Price in €																						
D	S	Re	d1	ap min	ap max	fn min	fn max	SW33105	SW22115	SW33115	SW22125	SW33125	SW22740	SW33740	SW44115	SW12920	SW22120	SW44125	SW22705	SW22320	SW00910	SW12910	SW22410	SW11415	SW11515			
								1	2	3	4	5	6	7	9	10	11	12	17	18	19	20	21	22	23			
20,00	6,35	-	6,50	2,00	8,00	0,20	2,00				22,17	25,42							22,17									
25,00	7,94	-	7,20	2,50	10,00	0,25	2,50	29,48		29,48	34,07																	
30,00	9,55	-	10,00	3,00	11,00	0,30	2,80			50,84		50,84																
32,00	9,52	-	9,50	3,20	12,80	0,32	3,20	49,76		49,76	57,33																	

Maße Dimensions (mm)		Schnittdaten Cutting Details				Preis in €   Price in €																						
D	S	Re	d1	ap min	ap max	fn min	fn max	SW33105	SW22115	SW33115	SW22125	SW33125	SW22740	SW33740	SW44115	SW12920	SW22120	SW44125	SW22705	SW22320	SW00910	SW12910	SW22410	SW11415	SW11515			
								1	2	3	4	5	6	7	9	10	11	12	17	18	19	20	21	22	23			
32,00	9,52	-	9,50	3,20	13,00	0,80	2,50	49,76	57,33	49,76	57,33								49,76	49,76								

Maße Dimensions (mm)		Schnittdaten Cutting Details				Preis in €   Price in €																						
D	S	Re	d1	ap min	ap max	fn min	fn max	SW33105	SW22115	SW33115	SW22125	SW33125	SW22740	SW33740	SW44115	SW12920	SW22120	SW44125	SW22705	SW22320	SW00910	SW12910	SW22410	SW11415	SW11515			
								1	2	3	4	5	6	7	9	10	11	12	17	18	19	20	21	22	23			
25,00	7,94	-	7,20	3,20	8,00	0,80	2,50	29,48	34,07	29,48	34,07																	
32,00	9,52	-	9,50	3,20	13,00	0,80	2,50	49,76	57,33	49,76	57,33		57,33															

# 6

## DREHHALTER & BOHRSTANGEN

### TOOLHOLDERS & BORING BARS

Halter und Bohrstangen für die gängigsten Drehplatten aus unserem Produktangebot.

*Toolholder and boring bars for the most common turning inserts of our product range.*

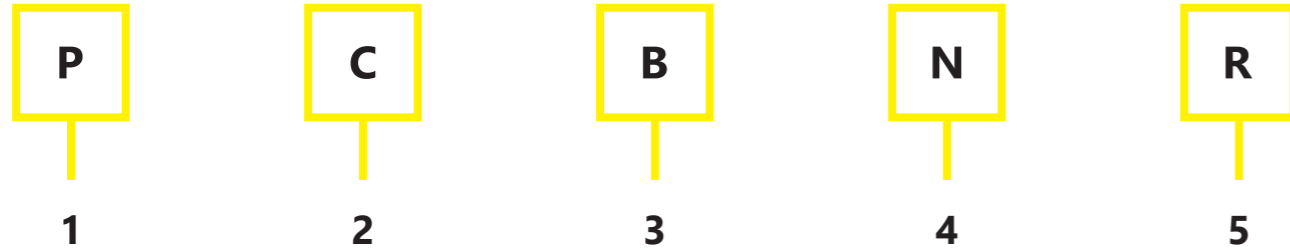

1. Fixierung der Platte *Insert Clamping*

M	P	S	T
Fixierung oben und in der Bohrung <i>Top and Hole Clamping</i>	Fixierung in der Bohrung <i>Hole Clamping (Lever Lock)</i>	Fixierung durch Anschrauben <i>Clamping by Screwing</i>	Fixierung oben und in der Bohrung <i>Top and Hole Clamping</i>

2. Plattenform *Insert Shape*

V	W	S	T	C	D	R
35°	80°	90°	60°	80°	55°	-

3. Halterform *Toolholder Shape*

A	B	D	E	G	J	K	L	S	T

4. Freiwinkel der Platte *Insert Clearance Angle*

B	C	N

5. Schnittrichtung *Cutting Direction*

L	N	R

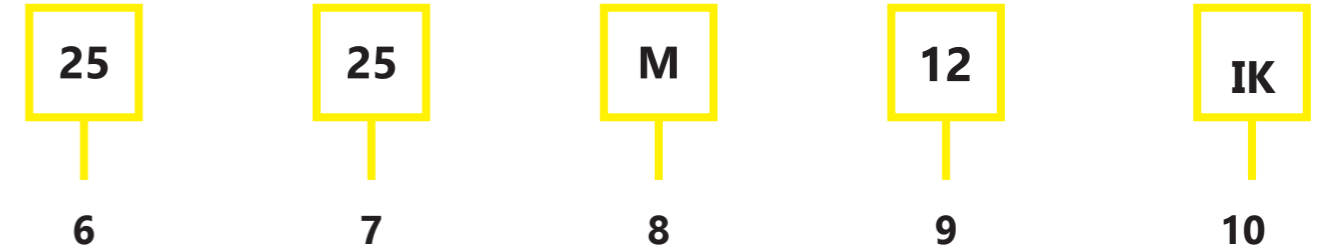

6. Höhe der Schneide (mm) *Cutting Edge Height (mm)*

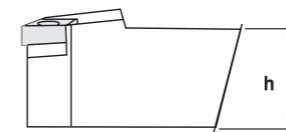

7. Schaftbreite (mm) *Shank Width (mm)*

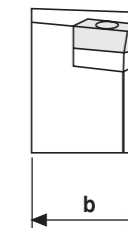

8. Schaftlänge (mm) *Shank Length (mm)*

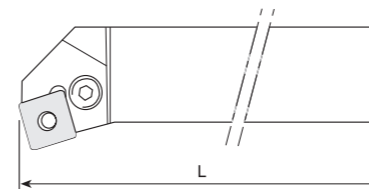

E	H	K	M	P
70	100	125	150	170

9. Länge der Schneide (mm) *Cutting Edge Length (mm)*

W	S	T	C	D	R

10. Halter mit Innenkühlung (IK) *Holder with Internal Coolant (IK)*

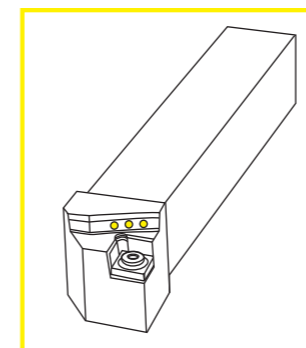

**SCLCR/L**

Plattentyp:  
Insert Type:  
CCMT/CCGT

Plattengröße Insert Size	Bestellcode Ordering Code	Maße (mm) Dimensions (mm)						Preis in € Price in €
		h <sub>1</sub>	h <sub>2</sub>	b	l <sub>1</sub>	l <sub>2</sub>	f	
CCMT/CCGT 09T3...	SCLCR/L 1616 H09 – IK G1/8	16	16	16	100	17	20	229,90
CCMT/CCGT 09T3...	SCLCR/L 2020 K09 – IK G1/8	20	20	20	125	17	25	237,60
CCMT/CCGT 1204...	SCLCR/L 2525 M12 – IK G1/8	25	25	25	150	20	32	249,70

ERSATZTEILE/ SPARE PARTS

Für Artikelnummer For Article Number	Unterlegplatte Anvil	Spannschraube U-Platte Anvil Screw	Spannschraube Clamping Screw
SCLCR/L 1616 H09 – IK G1/8	SW-UP14 / € 17,05	SW-GB-1 / € 8,25	SW-SS-10 / € 6,05
SCLCR/L 2020 K09 – IK G1/8			
SCLCR/L 2525 M12 – IK G1/8	SW-UP15 / € 20,90	SW-GB-2 / € 8,25	SW-SS-11 / € 6,05

**SDLJR/L**

Plattentyp:  
Insert Type:  
DCMT/DCGT

Plattengröße Insert Size	Bestellcode Ordering Code	Maße (mm) Dimensions (mm)						Preis in € Price in €
		h <sub>1</sub>	h <sub>2</sub>	b	l <sub>1</sub>	l <sub>2</sub>	f	
DCMT/DCGT 11T3...	SDJCR/L 1616 H11 – IK G1/8	16	16	16	100	20	20	229,90
DCMT/DCGT 11T3...	SDJCR/L 1616 H11 – IK G1/8	20	20	20	125	20,5	25	237,60
DCMT/DCGT 11T3...	SDJCR/L 2525 M11 – IK G1/8	25	25	25	150	21,5	32	249,70

ERSATZTEILE/ SPARE PARTS

Für Artikelnummer For Article Number	Unterlegplatte Anvil	Spannschraube U-Platte Anvil Screw	Spannschraube Clamping Screw
SDJCR/L 1616 H11 – IK G1/8	SW-UP16 / € 12,65	SW-GB-1 / € 8,25	SW-SS-10 / € 6,05
SDJCR/L 1616 H11 – IK G1/8			
SDJCR/L 2525 M11 – IK G1/8			

**SVJCR/L**

Plattentyp:  
Insert Type:  
VCMT/VCGT

Plattengröße Insert Size	Bestellcode Ordering Code	Maße (mm) Dimensions (mm)						Preis in € Price in €
		h <sub>1</sub>	h <sub>2</sub>	b	l <sub>1</sub>	l <sub>2</sub>	f	
VCMT/VCGT 1103...	SVJCR/L 1616 H11 – IK G1/8	16	16	16	100	21,5	20	229,90
VCMT/VCGT 1103...	SVJCR/L 2020 K11 – IK G1/8	20	20	20	125	23	25	237,60
VCMT/VCGT 1604...	SVJCR/L 2020 K16 – IK G1/8	20	20	20	125	29,5	25	237,60
VCMT/VCGT 1604...	SVJCR/L 2525 M16 – IK G1/8	25	25	25	150	32,5	32	249,70

ERSATZTEILE/ SPARE PARTS

Für Artikelnummer For Article Number	Unterlegplatte Anvil	Spannschraube U-Platte Anvil Screw	Spannschraube Clamping Screw
SVJCR/L 1616 H11 – IK G1/8	-	-	SW-SS-12 / € 6,05
SVJCR/L 2020 K11 – IK G1/8			
SVJCR/L 2020 K16 – IK G1/8			
SVJCR/L 2525 M16 – IK G1/8	SW-UP22 / € 17,05	SW-GB-1 / € 8,25	SW-SS-10 / € 6,05

**PCLNR/L**

Plattentyp:  
Insert Type:  
CNMG

Plattengröße Insert Size	Bestellcode Ordering Code	Maße (mm) Dimensions (mm)						Preis in € Price in €
		d	h <sub>1</sub>	h <sub>2</sub>	l <sub>1</sub>	l <sub>2</sub>	f	
CNMG 1204...	PCLNR/L 1616 H12 – IK G1/8	16	16	16	100	26,1	20	234,30
CNMG 1204...	PCLNR/L 2020 K12 – IK G1/8	20	20	20	125	27,4	25	245,30
CNMG 1204...	PCLNR/L 2525 M12 – IK G1/8	25	25	25	150	28	32	263,45

ERSATZTEILE/ SPARE PARTS

Für Artikelnummer For Article Number	Unterlegplatte Anvil	Hebel Lever	Spannschraube Clamping Screw	Rohrstift Shim Pin	Montagedorn Shim Pin Punch
PCLNR/L 1616 H12 – IK G1/8	SW-UP2 / € 13,75	SW-KH-1 / € 22,55	SW-SS-1 / € 6,05	SW-RS-2 / € 3,85	SW-MD-1 / € 2,20
PCLNR/L 2020 K12 – IK G1/8					
PCLNR/L 2525 M12 – IK G1/8					



**PDJNR/L**

93°

Plattentyp:  
Insert Type:

**DNMG**

Plattengröße Insert Size	Bestellcode Ordering Code	Maße (mm) Dimensions (mm)						Preis in € Price in €
		d	h <sub>1</sub>	h <sub>2</sub>	l <sub>1</sub>	l <sub>2</sub>	f	
DNMG 1104...	PDJNR/L 1616 H11 – IK G1/8	16	16	16	100	30	20	234,30
DNMG 1506...	PDJNR/L 2020 K15 – IK G1/8	20	20	20	125	30	25	245,30
DNMG 1506...	PDJNR/L 2525 M15 – IK G1/8	25	25	25	150	30	32	263,45

ERSATZTEILE / SPARE PARTS

Für Artikelnummer For Article Number	Unterlegplatte Anvil	Hebel Lever	Spannschraube Clamping Screw	Rohrstift Shim Pin	Montagedorn Shim Pin Punch
PCLNR/L 1616 H12 – IK G1/8	SW-UP6 / € 13,75	SW-KH-5 / € 122,00	SW-SS-6 / € 5,50	SW-RS-5 / € 3,85	SW-MD-4 / € 2,20
PCLNR/L 2020 K12 – IK G1/8	SW-UP7 / € 14,30	SW-KH-7 / € 23,65	SW-SS-1 / € 5,50	SW-RS-2 / € 4,40	SW-MD-1 / € 2,20
PCLNR/L 2525 M12 – IK G1/8					

**PWLNRL**

95°

Plattentyp:  
Insert Type:

**WNMG**

Plattengröße Insert Size	Bestellcode Ordering Code	Maße (mm) Dimensions (mm)						Preis in € Price in €
		d	h <sub>1</sub>	h <sub>2</sub>	l <sub>1</sub>	l <sub>2</sub>	f	
WNMG 0804...	PWLNRL/L 2020 K08 – IK G1/8	20	20	20	125	25	25	245,30
WNMG 0804...	PWLNRL/L 2525 M08 – IK G1/8	25	25	25	150	25	32	263,45

ERSATZTEILE / SPARE PARTS

Für Artikelnummer For Article Number	Unterlegplatte Anvil	Hebel Lever	Spannschraube Clamping Screw	Rohrstift Shim Pin	Montagedorn Shim Pin Punch
PWLNRL/L 2020 K08 – IK G1/8	SW-UP12 / € 14,85	SW-KH-1 / € 22,55	SW-SS-1 / € 6,05	SW-RS-2 / € 3,85	SW-MD-1 / € 2,20
PWLNRL/L 2525 M08 – IK G1/8					

**SCLCR/L**

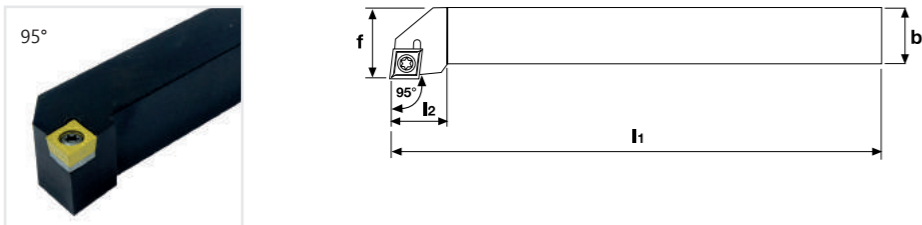

95°

Plattentyp:  
Insert Type:



CCMT/CCGT

Plattengröße Insert Size	Bestellcode Ordering Code	Maße (mm) Dimensions (mm)						Preis in € Price in €
		h <sub>1</sub>	h <sub>2</sub>	b	l <sub>1</sub>	l <sub>2</sub>	f	
CCMT/CCGT 0602...	SCLCR/L 0808 D06	8	8	8	60	9	10	72,60
CCMT/CCGT 0602...	SCLCR/L 1010 E06	10	10	10	70	9	12	72,60
CCMT/CCGT 09T3...	SCLCR/L 1212 F09	12	12	12	80	15	16	72,60
CCMT/CCGT 09T3...	SCLCR/L 1616 H09	16	16	16	100	17	20	85,25
CCMT/CCGT 09T3...	SCLCR/L 2020 K09	20	20	20	125	17	25	87,45
CCMT/CCGT 09T3...	SCLCR/L 2525 M09	25	25	25	150	20	32	96,80
CCMT/CCGT 1204...	SCLCR/L 1616 H12	16	16	16	100	20	32	85,25
CCMT/CCGT 1204...	SCLCR/L 2020 K12	20	20	20	125	20	25	87,45
CCMT/CCGT 1204...	SCLCR/L 2525 M12	25	25	25	150	20	32	96,80

ERSATZTEILE / SPARE PARTS

Für Artikelnummer For Article Number	Unterlegplatte Anvil	Spannschraube U-Platte Anvil Screw	Spannschraube Clamping Screw
SCLCR/L 0808 D06			SW-SS-12 / € 6,05
SCLCR/L 1010 E06			SW-SS-12 / € 6,05
SCLCR/L 1212 F09			SW-SS-10 / € 6,05
SCLCR/L 1616 H09	SW-UP14 / € 17,05	SW-GB-1 / € 8,25	SW-SS-10 / € 6,05
SCLCR/L 2020 K09			SW-SS-10 / € 6,05
SCLCR/L 2525 M09			SW-SS-10 / € 6,05
SCLCR/L 1616 H12	SW-UP15 / € 20,90	SW-GB-2 / € 8,25	SW-SS-11 / € 6,05
SCLCR/L 2020 K12			SW-SS-11 / € 6,05
SCLCR/L 2525 M12			SW-SS-11 / € 6,05

**SDHCR/L**

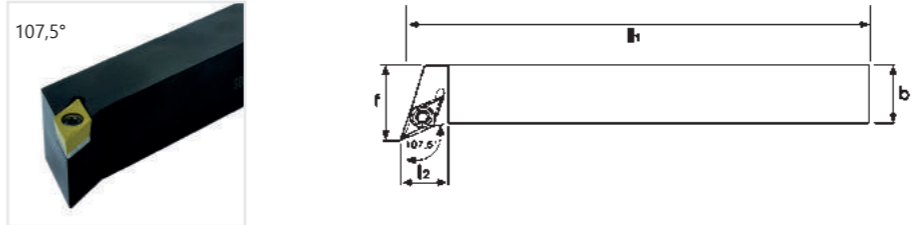

107,5°

Plattentyp:  
Insert Type:



DCMT/DCGT

Plattengröße Insert Size	Bestellcode Ordering Code	Maße (mm) Dimensions (mm)						Preis in € Price in €
		h <sub>1</sub>	h <sub>2</sub>	b	l <sub>1</sub>	l <sub>2</sub>	f	
DCMT/DCGT 0702...	SDHCR/L 1010 E07	10	10	10	70	5,5	12	72,60
DCMT/DCGT 0702...	SDHCR/L 1212 F07	12	12	12	80	12	16	72,60
DCMT/DCGT 11T3...	SDHCR/L 1616 H11	16	16	16	100	10,4	20	85,25
DCMT/DCGT 11T3...	SDHCR/L 2020 K11	20	20	20	125	14	25	87,45
DCMT/DCGT 11T3...	SDHCR/L 2525 M11	25	25	25	150	20	32	96,80

ERSATZTEILE / SPARE PARTS

Für Artikelnummer For Article Number	Unterlegplatte Anvil	Spannschraube U-Platte Anvil Screw	Spannschraube Clamping Screw
SDHCR/L 1010 E07			SW-SS-12 / € 6,05
SDHCR/L 1212 F07			SW-SS-12 / € 6,05
SDHCR/L 1616 H11	SW-UP16 / € 12,65	SW-GB-1 / € 8,25	SW-SS-10 / € 6,05
SDHCR/L 2020 K11			SW-SS-10 / € 6,05
SDHCR/L 2525 M11			SW-SS-10 / € 6,05

SDJCR/L								Plattentyp: Insert Type:  DCMT/DCGT
Plattengröße Insert Size	Bestellcode Ordering Code	Maße (mm) Dimensions (mm)						Preis in € Price in €
		h <sub>1</sub>	h <sub>2</sub>	b	l <sub>1</sub>	l <sub>2</sub>	f	
DCMT/DCGT 0702...	SDJCR/L 0808 007	8	8	8	60	13	10	72,60
DCMT/DCGT 0702...	SDJCR/L 1010 E07	10	10	10	70	13	12	72,60
DCMT/DCGT 0702...	SDJCR/L 1212 F07	12	12	12	80	14,5	16	72,60
DCMT/DCGT 11T3...	SDJCR/L 1616 H11	16	16	16	100	20	20	85,25
DCMT/DCGT 11T3...	SDJCR/L 2020 K11	20	20	20	125	20,5	25	87,45
DCMT/DCGT 11T3...	SDJCR/L 2525 M11	25	25	25	150	21,5	32	96,80

ERSATZTEILE/ SPARE PARTS

Für Artikelnummer For Article Number	Unterlegplatte Anvil	Spannschraube U-Platte Anvil Screw	Spannschraube Clamping Screw
SDJCR/L 0808 007			SW-SS-12 / € 6,05
SDJCR/L 1010 E07			
SDJCR/L 1212 F07			
SDJCR/L 1616 H11	SW-UP16 / € 12,65	SW-GB-1 / € 8,25	SW-SS-10 / € 6,05
SDJCR/L 2020 K11			
SDJCR/L 2525 M11			

SRDCN							Plattentyp: Insert Type:  RCMT/RCGT
Plattengröße Insert Size	Bestellcode Ordering Code	Maße (mm) Dimensions (mm)					Preis in € Price in €
		h <sub>1</sub>	h <sub>2</sub>	l <sub>1</sub>	l <sub>2</sub>	f	
RCMT/RCGT 0602...	SRDCN 1212 F06	12	12	80	12,4	6	81,95
RCMT/RCGT 0602...	SRDCN 1616 H06	16	16	100	12,4	8	81,95
RCMT/RCGT 0602...	SRDCN 2020 K06	20	20	125	12,4	10	105,60
RCMT/RCGT 0602...	SRDCN 2525 M06	25	25	150	12,4	12,5	118,25
RCMT/RCGT 0803...	SRDCN 1616 H08	16	16	100	16,4	8	91,85
RCMT/RCGT 0803...	SRDCN 2020 K08	20	20	125	16,4	10	107,80
RCMT/RCGT 0803...	SRDCN 2525 M08	16	16	100	20	32	118,25
RCMT/RCGT 1003...	SRDCN 1616 H10	16	16	100	17	20	91,85
RCMT/RCGT 1003...	SRDCN 2020 K10	20	20	125	17	25	107,80
RCMT/RCGT 1003...	SRDCN 2525 M10	25	25	150	20,3	12,5	118,25
RCMT/RCGT 1203...	SRDCN 2020 K12	20	20	125	20,3	10	107,80
RCMT/RCGT 1203...	SRDCN 2525 M12	25	25	150	20,3	12,5	118,25

ERSATZTEILE/ SPARE PARTS

Für Artikelnummer For Article Number	Unterlegplatte Anvil	Spannschraube U-Platte Anvil Screw	Spannschraube Clamping Screw
SRDCN 1212 F06			SW-SS-12 / € 6,05
SRDCN 1616 H06			
SRDCN 2020 K06			
SRDCN 2525 M06			SW-SS-13 / € 6,05
SRDCN 1616 H08			
SRDCN 2020 K08			
SRDCN 2525 M08			SW-SS-10 / € 6,05
SRDCN 1616 H10	SW-UP17 / € 17,05	SW-GB-1 / € 8,25	
SRDCN 2020 K10			
SRDCN 2525 M10			
SRDCN 2020 K12	SW-UP18 / € 20,90		
SRDCN 2525 M12			

SSDCN								Plattentyp: Insert Type: SCMT/SCGT
Plattengröße Insert Size	Bestellcode Ordering Code	Maße (mm) Dimensions (mm)						Preis in € Price in €
		h <sub>1</sub>	h <sub>2</sub>	b	l <sub>1</sub>	l <sub>2</sub>	f	
SCMT/SCGT 09T3...	SSDCN 1212 F09	12	12	12	80	16	6	73,70
SCMT/SCGT 09T3...	SSDCN 1616 H09	16	16	16	100	20	8	85,25
SCMT/SCGT 09T3...	SSDCN 2020 K09	20	20	20	125	20	10	96,80
SCMT/SCGT 1204...	SSDCN 1616 H12	16	16	16	100	25	8	90,75
SCMT/SCGT 1204...	SSDCN 2020 K12	20	20	20	125	25	10	96,80
SCMT/SCGT 1204...	SSDCN 2525 M12	25	25	25	150	25	12,5	102,30

ERSATZTEILE / SPARE PARTS

Für Artikelnummer For Article Number	Unterlegplatte Anvil	Spannschraube U-Platte Anvil Screw	Spannschraube Clamping Screw
SSDCN 1212 F09	SW-UP19 / € 17,05	SW-GB-1 / € 8,25	SW-SS-10 / € 6,05
SSDCN 1616 H09			
SSDCN 2020 K09			
SSDCN 1616 H12	SW-UP20 / € 17,05	SW-GB-2 / € 8,25	SW-SS-11 / € 6,05
SSDCN 2020 K12			
SSDCN 2525 M12			

SSSCR/L								Plattentyp: Insert Type: SCMT/SCGT
Plattengröße Insert Size	Bestellcode Ordering Code	Maße (mm) Dimensions (mm)						Preis in € Price in €
		h <sub>1</sub>	h <sub>2</sub>	b	l <sub>1</sub>	l <sub>2</sub>	f	
SCMT/SCGT 09T3...	SSSCR/L 1212 F09	12	12	12	80	18	16	72,60
SCMT/SCGT 09T3...	SSSCR/L 1616 H09	16	16	16	100	20	20	85,25
SCMT/SCGT 09T3...	SSSCR/L 2020 K09	20	20	20	125	20	25	87,45
SCMT/SCGT 1204...	SSSCR/L 1616 H12	16	16	16	100	25	20	85,25
SCMT/SCGT 1204...	SSSCR/L 2020 K12	20	20	20	125	25	25	87,45
SCMT/SCGT 1204...	SSSCR/L 2525 M12	25	25	25	150	25	32	96,80

ERSATZTEILE / SPARE PARTS

Für Artikelnummer For Article Number	Unterlegplatte Anvil	Spannschraube U-Platte Anvil Screw	Spannschraube Clamping Screw
SSSCR/L 1212 F09	SW-UP19 / € 17,05	SW-GB-1 / € 8,25	SW-SS-10 / € 6,05
SSSCR/L 1616 H09			
SSSCR/L 2020 K09			
SSSCR/L 1616 H12	SW-UP20 / € 17,05	SW-GB-2 / € 8,25	SW-SS-11 / € 6,05
SSSCR/L 2020 K12			
SSSCR/L 2525 M12			

**SVHBR/L**

Plattentyp:  
Insert Type:

**VBMT**

Plattengröße Insert Size	Bestellcode Ordering Code	Maße (mm) Dimensions (mm)						Preis in € Price in €
		h <sub>1</sub>	h <sub>2</sub>	b	l <sub>1</sub>	l <sub>2</sub>	f	
VBMT 1103...	SVHBR/L 1212 F11	12	12	12	80	11,4	16	88,55
VBMT 1103...	SVHBR/L 1616 H11	16	16	16	100	11,4	20	88,55
VBMT 1103...	SVHBR/L 2020 K11	20	20	20	125	14,6	25	95,70
VBMT 1604...	SVHBR/L 2020 K16	20	20	20	125	13,2	25	105,60
VBMT 1604...	SVHBR/L 2525 M16	25	25	25	150	19,6	32	118,25

ERSATZTEILE / SPARE PARTS

Für Artikelnummer For Article Number	Unterlegplatte Anvil	Spannschraube U-Platte Anvil Screw	Spannschraube Clamping Screw
SVHBR/L 1212 F11			SW-SS-12 / € 6,05
SVHBR/L 1616 H11			
SVHBR/L 2020 K11			
SVHBR/L 2020 K16	SW-UP22 / € 17,05	SW-GB-1 / € 8,25	SW-SS-10 / € 6,05
SVHBR/L 2525 M16			

**SVHCR/L**

Plattentyp:  
Insert Type:

**VCMT/VCMT**

Plattengröße Insert Size	Bestellcode Ordering Code	Maße (mm) Dimensions (mm)				Preis in € Price in €
		h <sub>1</sub>	h <sub>2</sub>	b	l <sub>1</sub>	
VCMT/VCMT 1103...	SVHCR/L 1212 F11	12	12	12	80	88,55
VCMT/VCMT 1103...	SVHCR/L 1616 H11	16	16	16	100	88,55
VCMT/VCMT 1103...	SVHCR/L 2020 K11	20	20	20	125	95,70
VCMT/VCMT 1103...	SVHCR/L 2525 M11	25	25	25	150	105,60
VCMT/VCMT 1604...	SVHCR/L 2020 K16	20	20	20	125	105,60
VCMT/VCMT 1604...	SVHCR/L 2525 M16	25	25	25	150	118,25

ERSATZTEILE / SPARE PARTS

Für Artikelnummer For Article Number	Unterlegplatte Anvil	Spannschraube U-Platte Anvil Screw	Spannschraube Clamping Screw
SVHCR/L 1212 F11			SW-SS-12 / € 6,05
SVHCR/L 1616 H11			
SVHCR/L 2020 K11			
SVHCR/L 2525 M11	SW-UP22 / € 17,05	SW-GB-1 / € 8,25	SW-SS-10 / € 6,05
SVHCR/L 2020 K16			
SVHCR/L 2525 M16			

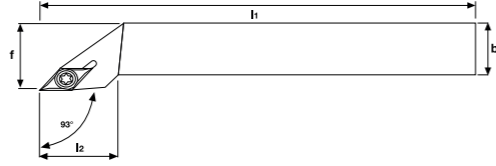

**SVJBR/L**

Plattentyp:  
Insert Type:

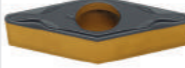

VBMT

Plattengröße Insert Size	Bestellcode Ordering Code	Maße (mm) Dimensions (mm)						Preis in € Price in €
		h <sub>1</sub>	h <sub>2</sub>	b	l <sub>1</sub>	l <sub>2</sub>	f	
VBMT 1103...	SVJBR/L 1616 H11	16	16	16	100	21,5	20	88,55
VBMT 1103...	SVJBR/L 2020 K11	20	20	20	125	23	25	95,70
VBMT 1604...	SVJBR/L 2020 K16	20	20	20	125	29,5	25	95,70
VBMT 1604...	SVJBR/L 2525 M16	25	25	25	150	32,5	32	118,25

ERSATZTEILE / SPARE PARTS

Für Artikelnummer For Article Number	Unterlegplatte Anvil	Spannschraube U-Platte Anvil Screw	Spannschraube Clamping Screw
SVJBR/L 1616 H11			SW-SS-12 / € 6,05
SVJBR/L 2020 K11			
SVJBR/L 2020 K16	SW-UP22 / € 17,05	SW-GB-1 / € 8,25	SW-SS-10 / € 6,05
SVJBR/L 2525 M16			

**SVJCR/L**

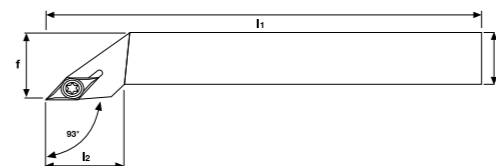
Plattentyp:  
Insert Type:



VCMT/VCMT

Plattengröße Insert Size	Bestellcode Ordering Code	Maße (mm) Dimensions (mm)						Preis in € Price in €
		h <sub>1</sub>	h <sub>2</sub>	b	l <sub>1</sub>	l <sub>2</sub>	f	
VCMT/VCMT 1103...	SVJCR/L 1212 F11	12	12	12	80	21,5	16	88,55
VCMT/VCMT 1103...	SVJCR/L 1616 H11	16	16	16	100	21,5	20	88,55
VCMT/VCMT 1103...	SVJCR/L 2020 K11	20	20	20	125	23	25	95,70
VCMT/VCMT 1103...	SVJCR/L 2525 M11	25	25	25	150	25,5	32	105,60
VCMT/VCMT 1604...	SVJCR/L 2020 K16	20	20	20	125	29,5	25	95,70
VCMT/VCMT 1604...	SVJCR/L 2525 M16	25	25	25	150	32,5	32	105,60

ERSATZTEILE / SPARE PARTS

Für Artikelnummer For Article Number	Unterlegplatte Anvil	Spannschraube U-Platte Anvil Screw	Spannschraube Clamping Screw
SVJCR/L 1212 F11			SW-SS-10 / € 6,05
SVJCR/L 1616 H11			
SVJCR/L 2020 K11			
SVJCR/L 2525 M11			SW-SS-10 / € 6,05
SVJCR/L 2020 K16	SW-UP22 / € 17,05	SW-GB-1 / € 8,25	
SVJCR/L 2525 M16			

SVVBN								Plattentyp: Insert Type:  VBMT
Plattengröße Insert Size	Bestellcode Ordering Code	Maße (mm) Dimensions (mm)						Preis in € Price in €
		h <sub>1</sub>	h <sub>2</sub>	b	l <sub>1</sub>	l <sub>2</sub>	f	
VBMT 1103...	SVVBN 1212 F11	12	12	12	80	19	6	79,75
VBMT 1103...	SVVBN 1616 H11	16	16	16	100	25	6	85,25
VBMT 1103...	SVVBN 2020 K11	20	20	20	125	32	10	87,45
VBMT 1103...	SVVBN 2525 M11	25	25	25	150	40	12,5	96,80
VBMT 1604...	SVVBN 2020 K16	20	20	20	125	32	10	95,70
VBMT 1604...	SVVBN 2525 M16	25	25	25	150	40	12,5	105,60

ERSATZTEILE/ SPARE PARTS

Für Artikelnummer For Article Number	Unterlegplatte Anvil	Spannschraube U-Platte Anvil Screw	Spannschraube Clamping Screw
SVVBN 1212 F11			SW-SS-12 / € 6,05
SVVBN 1616 H11			
SVVBN 2020 K11			
SVVBN 2525 M11			
SVVBN 2020 K16	SW-UP22 / € 17,05	SW-GB-1 / € 8,25	SW-SS-10 / € 6,05
SVVBN 2525 M16			

SVVCN								Plattentyp: Insert Type:  VCMT/VCGT
Plattengröße Insert Size	Bestellcode Ordering Code	Maße (mm) Dimensions (mm)						Preis in € Price in €
		h <sub>1</sub>	h <sub>2</sub>	b	l <sub>1</sub>	l <sub>2</sub>	f	
VCMT/VCGT 0702...	SVVCN 0808 K07	8	8	8	125	15	4	64,90
VCMT/VCGT 0702...	SVVCN 1010 M07	10	10	10	150	16	5	69,30
VCMT/VCGT 0702...	SVVCN 1212 M07	12	12	12	150	19	6	73,70
VCMT/VCGT 1103...	SVVCN 1212 F11	12	12	12	80	19	6	79,75
VCMT/VCGT 1103...	SVVCN 1616 H11	16	16	16	100	25	8	85,25
VCMT/VCGT 1103...	SVVCN 2020 K11	20	20	20	125	32	10	87,45
VCMT/VCGT 1604...	SVVCN 2525 M11	25	25	25	150	40	12,5	96,80
VCMT/VCGT 1604...	SVVCN 2020 K16	20	20	20	125	32	10	95,70
VCMT/VCGT 1604...	SVVCN 2525 M16	25	25	25	150	40	12,5	105,60

ERSATZTEILE/ SPARE PARTS

Für Artikelnummer For Article Number	Unterlegplatte Anvil	Spannschraube U-Platte Anvil Screw	Spannschraube Clamping Screw
SVVCN 0808 K07			SW-SS-15 / € 6,05
SVVCN 1010 M07			
SVVCN 1212 M07			
SVVCN 1212 F11			SW-SS-12 / € 6,05
SVVCN 1616 H11			
SVVCN 2020 K11			
SVVCN 2525 M11			
SVVCN 2020 K16	SW-UP22 / € 17,05	SW-GB-1 / € 8,25	SW-SS-10 / € 6,05
SVVCN 2525 M16			

Plattengröße Insert Size		Bestellcode Ordering Code		Maße (mm) Dimensions (mm)				Preis in € Price in €		
				$h_1$	$h_2$	$b$	$l_1$	$l_2$	$f$	
TN...1604...		MTJNR/L 2020 K16		20	20	20	125	35	25	108,80
TN...1604...		MTJNR/L 2525 M16		25	25	25	150	32	32	118,40

ERSATZTEILE / SPARE PARTS

Für Artikelnummer For Article Number	Klemme Clamp	Keilstück Wedge	Unterlegplatte Anvil	Passstift Pin
MTJNR/L 2020 K16	SW-KL-1 / € 30,80	SW-KS-1 / € 12,65	SW-UP-1 / € 10,45	SW-RS-1 / € 2,75
MTJNR/L 2525 M16	SW-KL-1 / € 30,80	SW-KS-1 / € 12,65	SW-UP-1 / € 10,45	SW-RS-1 / € 2,75

Plattengröße Insert Size		Bestellcode Ordering Code		Maße (mm) Dimensions (mm)				Preis in € Price in €		
				$h_1$	$h_2$	$b$	$l_1$	$l_2$	$f$	
CN...0903...		PCLNR/L 1616 H09		16	16	16	100	23	20	105,60
CN...1204...		PCLNR/L 1616 H12		16	16	16	100	26,1	20	105,60
CN...0903...		PCLNR/L 2020 K09		20	20	20	125	25	25	118,40
CN...1204...		PCLNR/L 2020 K12		20	20	20	125	27,4	25	118,40
CN...0903...		PCLNR/L 2525 M09		25	25	25	150	28	32	118,40
CN...1204...		PCLNR/L 2525 M12		25	25	25	150	28	32	118,40
CN...1606...		PCLNR/L 2525 M16		25	25	25	150	28	32	118,40
CN...1204...		PCLNR/L 3225 P12		32	32	32	170	32,6	32	124,80
CN...1606...		PCLNR/L 3232 P16		32	32	32	170	32,6	40	153,60
CN...1906...		PCLNR/L 3232 P19		32	32	32	170	38	40	153,60
CN...1906...		PCLNR/L 4040 S19		40	40	40	250	38	50	188,80

ERSATZTEILE / SPARE PARTS

Für Artikelnummer For Article Number	Unterlegplatte Anvil	Hebel Lever	Spannschraube Clamping Screw	Rohrstift Shim Pin	Montagedorn Shim Pin Punch
PCLNR/L 1616 H09	SW-UP3 / € 11,00	SW-KH-8 / € 22,00	SW-SS-6 / € 5,50	SW-RS-5 / € 3,85	SW-MD-4 / € 2,20
PCLNR/L 1616 H12	SW-UP2 / € 13,75	SW-KH-1 / € 22,55	SW-SS-1 / € 6,05	SW-RS-2 / € 3,85	SW-MD-1 / € 2,20
PCLNR/L 2020 K09	SW-UP3 / € 11,00	SW-KH-8 / € 22,00	SW-SS-6 / € 5,50	SW-RS-5 / € 3,85	SW-MD-4 / € 2,20
PCLNR/L 2020 K12	SW-UP2 / € 13,75	SW-KH-1 / € 22,55	SW-SS-1 / € 6,05	SW-RS-2 / € 3,85	SW-MD-1 / € 2,20
PCLNR/L 2525 M09	SW-UP3 / € 11,00	SW-KH-8 / € 22,00	SW-SS-6 / € 5,50	SW-RS-5 / € 3,85	SW-MD-4 / € 2,20
PCLNR/L 2525 M12	SW-UP2 / € 13,75	SW-KH-1 / € 22,55	SW-SS-1 / € 6,05	SW-RS-2 / € 3,85	SW-MD-1 / € 2,20
PCLNR/L 2525 M16	SW-UP4 / € 22,55	SW-KH-3 / € 22,00	SW-SS-4 / € 6,05	SW-RS-3 / € 3,85	SW-MD-2 / € 2,20
PCLNR/L 3225 P12	SW-UP2 / € 13,75	SW-KH-1 / € 22,55	SW-SS-1 / € 6,05	SW-RS-2 / € 3,85	SW-MD-1 / € 2,20
PCLNR/L 3232 P16	SW-UP4 / € 22,55	SW-KH-3 / € 22,00	SW-SS-4 / € 6,05	SW-RS-3 / € 3,85	SW-MD-2 / € 2,20
PCLNR/L 3232 P19	SW-UP5 / € 33,00	SW-KH-4 / € 33,00	SW-SS-5 / € 6,05	SW-RS-4 / € 3,850	SW-MD-3 / € 2,20
PCLNR/L 4040 S19	SW-UP5 / € 33,00	SW-KH-4 / € 33,00	SW-SS-5 / € 6,05	SW-RS-4 / € 3,85	SW-MD-3 / € 2,20

Plattengröße Insert Size		Maße (mm) Dimensions (mm)						Preis in € Price in €
Bestellcode Ordering Code		$h_1$	$h_2$	$b$	$l_1$	$l_2$	$f$	
DN...1104...	PDJNR/L 1616 H11	16	16	16	100	30	20	102,30
DN...1104...	PDJNR/L 2020 K11	20	20	20	125	30	25	110,00
DN...1506...	PDJNR/L 2020 K15	20	20	20	125	34,7	25	110,00
DN...1104...	PDJNR/L 2525 M11	25	25	25	150	30	32	110,00
DN...1506...	PDJNR/L 2525 M15	25	25	25	150	34,7	32	110,00
DN...1104...	PDJNR/L 3225 P11	32	32	25	170	30	32	123,75
DN...1506..	PDJNR/L 3232 P15	23	32	32	170	34,7	40	144,10

ERSATZTEILE / SPARE PARTS

Für Artikelnummer For Article Number	Unterlegplatte Anvil	Hebel Lever	Spannschraube Clamping Screw	Rohrstift Shim Pin	Montagedorn Shim Pin Punch
PDJNR/L 1616 H11	SW-UP6 / € 13,75	SW-KH-5 / € 22,00	SW-SS-6 / € 5,50	SW-RS-5/ € 3,85	SW-MD-4 / € 2,20
PDJNR/L 2020 K11	SW-UP6 / € 13,75	SW-KH-5 / € 22,00	SW-SS-6 / € 5,50	SW-RS-5/ € 3,85	SW-MD-4 / € 2,20
PDJNR/L 2020 K15	SW-UP7 / € 14,30	SW-KH-7 / € 23,65	SW-SS-10 / € 6,05	SW-RS-2/ € 3,85	SW-MD-1 / € 2,20
PDJNR/L 2525 M11	SW-UP6 / € 13,75	SW-KH-5 / € 22,00	SW-SS-6 / € 5,50	SW-RS-5/ € 3,85	SW-MD-4 / € 2,20
PDJNR/L 2525 M15	SW-UP7 / € 14,30	SW-KH-7 / € 23,65	SW-SS-10 / € 6,05	SW-RS-2/ € 3,85	SW-MD-1 / € 2,20
PDJNR/L 3225 P11	SW-UP6 / € 13,75	SW-KH-5 / € 22,00	SW-SS-6 / € 5,50	SW-RS-5/ € 3,85	SW-MD-4 / € 2,20
PDJNR/L 3232 P15	SW-UP7 / € 14,30	SW-KH-7 / € 23,65	SW-SS-10 / € 6,05	SW-RS-2/ € 3,85	SW-MD-1 / € 2,20

Plattengröße Insert Size		Maße (mm) Dimensions (mm)						Preis in € Price in €
Bestellcode Ordering Code		$h_1$	$h_2$	$b$	$l_1$	$l_2$	$f$	
SN...1204...	PSKNR/L 2020 K12	20	20	20	125	22,7	25	110,00
SN...1204...	PSKNR/L 2525 M12	25	25	25	150	22,7	32	110,00
SN...1506...	PSKNR/L 2525 M15	25	25	25	150	22,7	32	110,00
SN...1506...	PSKNR/L 3232 P15	32	32	32	170	32	40	144,10
SN...1906...	PSKNR/L 3232 P19	32	32	32	170	33,7	40	144,10

ERSATZTEILE / SPARE PARTS

Für Artikelnummer For Article Number	Unterlegplatte Anvil	Hebel Lever	Spannschraube Clamping Screw	Rohrstift Shim Pin	Montagedorn Shim Pin Punch
PSKNR/L 2020 K12	SW-UP8 / € 11,00	SW-KH-1 / € 22,55	SW-SS-1 / € 6,05	SW-RS-2/ € 3,85	SW-MD-1 / € 2,20
PSKNR/L 2525 M12	SW-UP8 / € 11,00	SW-KH-1 / € 22,55	SW-SS-1 / € 6,05	SW-RS-2/ € 3,85	SW-MD-1 / € 2,20
PSKNR/L 2525 M15	SW-UP10 / € 14,30	SW-KH-3 / € 22,00	SW-SS-4 / € 6,05	SW-RS-3/ € 3,85	SW-MD-2 / € 2,20
PSKNR/L 3232 P15	SW-UP10 / € 14,30	SW-KH-3 / € 22,00	SW-SS-4 / € 6,05	SW-RS-3/ € 3,85	SW-MD-2 / € 2,20
PSKNR/L 3232 P19	SW-UP9/ € 32,45	SW-KH-4 / € 33,00	SW-SS-5 / € 6,05	SW-RS-4/ € 3,85	SW-MD-3 / € 2,20

PSSNR/L								Plattentyp: Insert Type: 
Plattengröße Insert Size	Bestellcode Ordering Code	Maße (mm) Dimensions (mm)						Preis in € Price in €
		h <sub>1</sub>	h <sub>2</sub>	b	l <sub>1</sub>	l <sub>2</sub>	f	
SN...1204...	PSSNR/L 2020 K12	20	20	20	125	29,3	25	110,00
SN...1204...	PSSNR/L 2525 M12	25	25	25	150	29,3	32	110,00
SN...1506...	PSSNR/L 2525 M15	25	25	25	150	29,3	32	110,00
SN...1506...	PSSNR/L 3232 P15	32	32	32	170	32	40	144,10

ERSATZTEILE/ SPARE PARTS

Für Artikelnummer For Article Number	Unterlegplatte Anvil	Hebel Lever	Spannschraube Clamping Screw	Rohrstift Shim Pin	Montagedorn Shim Pin Punch
PSSNR/L 2020 K12	SW-UP8 / € 11,00	SW-KH-1 / € 22,55	SW-SS-1 / € 6,05	SW-RS-2/ € 3,85	SW-MD-1 / € 2,20
PSSNR/L 2525 M12	SW-UP8 / € 11,00	SW-KH-1 / € 22,55	SW-SS-1 / € 6,05	SW-RS-2/ € 3,85	SW-MD-1 / € 2,20
PSSNR/L 2525 M15	SW-UP10 / € 14,30	SW-KH-3 / € 22,00	SW-SS-4 / € 6,05	SW-RS-3/ € 3,85	SW-MD-2 / € 2,20
PSSNR/L 3232 P15	SW-UP10 / € 14,30	SW-KH-3 / € 22,00	SW-SS-4 / € 6,05	SW-RS-3/ € 3,85	SW-MD-2 / € 2,20

PWLNR/L								Plattentyp: Insert Type: 
Plattengröße Insert Size	Bestellcode Ordering Code	Maße (mm) Dimensions (mm)						Preis in € Price in €
		h <sub>1</sub>	h <sub>2</sub>	b	l <sub>1</sub>	l <sub>2</sub>	f	
WN...0604...	PWLNR/L 1616 H06	16	16	16	100	20	20	102,30
WN...0604...	PWLNR/L 2020 K06	20	20	20	125	25	25	110,00
WN...0804...	PWLNR/L 2020 K08	20	20	20	125	25	25	110,00
WN...0604...	PWLNR/L 2525 M06	25	25	25	150	25	32	110,00
WN...0804...	PWLNR/L 2525 M08	25	25	25	150	25	32	110,00
WN...0804...	PWLNR/L 3225 P08	32	32	25	170	25	32	123,75

ERSATZTEILE/ SPARE PARTS

Für Artikelnummer For Article Number	Unterlegplatte Anvil	Hebel Lever	Spannschraube Clamping Screw	Rohrstift Shim Pin	Montagedorn Shim Pin Punch
PWLNR/L 1616 H06	SW-UP13 / € 16,50	SW-KH-8 / € 22,00	SW-SS-6 / € 5,50	SW-RS-5/ € 3,85	SW-MD-4 / € 2,20
PWLNR/L 2020 K06	SW-UP13 / € 16,50	SW-KH-8 / € 22,00	SW-SS-6 / € 5,50	SW-RS-5/ € 3,85	SW-MD-4 / € 2,20
PWLNR/L 2020 K08	SW-UP12 / € 14,85	SW-KH-1 / € 22,55	SW-SS-1 / € 6,05	SW-RS-2/ € 3,85	SW-MD-1 / € 2,20
PWLNR/L 2525 M06	SW-UP13 / € 16,50	SW-KH-8 / € 22,00	SW-SS-6 / € 5,50	SW-RS-5/ € 3,85	SW-MD-4 / € 2,20
PWLNR/L 2525 M08	SW-UP12 / € 14,85	SW-KH-1 / € 22,55	SW-SS-1 / € 6,05	SW-RS-2/ € 3,85	SW-MD-1 / € 2,20
PWLNR/L 3225 P08	SW-UP12 / € 14,85	SW-KH-1 / € 22,55	SW-SS-1 / € 6,05	SW-RS-2/ € 3,85	SW-MD-1 / € 2,20





1. Bohrstangen-Typ *Type of Boring Bar*

A	S
Stahl mit Kühlmittelöffnung Steel with Coolant Hole	Stahlschaft Steel Shank

2. Schaftdurchmesser (mm) *Shank Diameter (mm)*

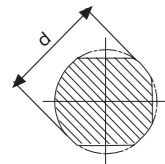

3. Schaftlänge (mm) *Shank Length (mm)*

P	R	S	T
170	200	250	300

4. Fixierung der Platte *Insert Clamping*

P	S
<p>Fixierung in der Bohrung Hole Clamping (Lever Lock)</p>	<p>Fixierung durch Anschrauben Clamping by Screwing</p>

5. Plattenform *Insert Shape*

W	S	C
<p>80°</p>	<p>90°</p>	<p>80°</p>

6. Bohrstangengeometrie *Boring Bar Geometry*

F	K	L
<p>90°</p>	<p>75°</p>	<p>95°</p>

7. Freiwinkel der Platte *Insert Clearance Angle*

C	N
<p>7°</p>	<p>0°</p>

8. Schnittrichtung *Cutting Direction*

L	R

9. Länge der Schnittkante (mm) *Cutting Edge Length (mm)*

W	S	C
<p>l</p>	<p>l</p>	<p>l</p>

10. Bohrstange mit Spannpratze *Boring Bar with Clamping Wedge*

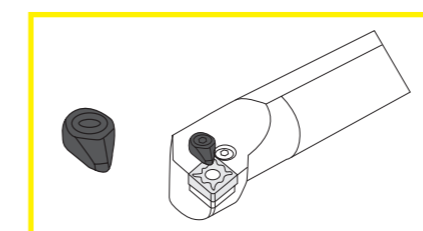

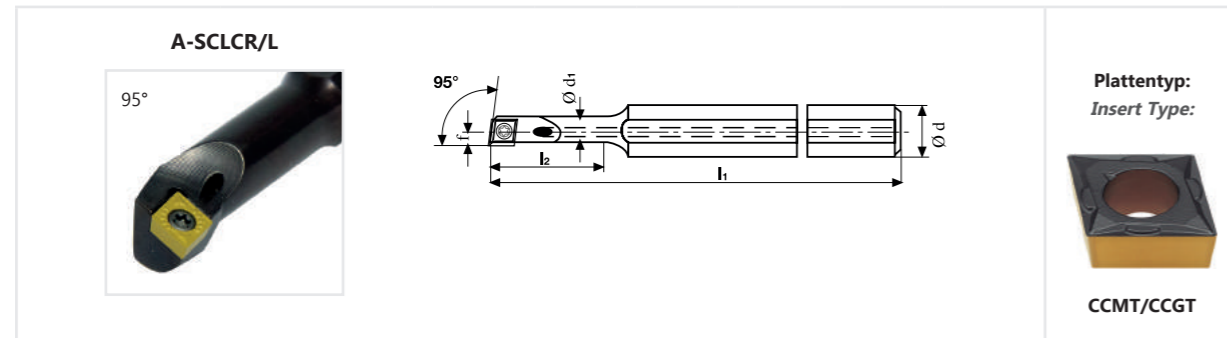

Plattentyp:  
Insert Type:  
  
CCMT/CCGT

STAHL/STEEL	Plattengröße Insert Size	Bestellcode Ordering Code	Maße (mm) Dimensions (mm)					Preis in € Price in €	
			d	d <sub>1</sub>	f	l <sub>1</sub>	l <sub>2</sub>		D min
	CCMT/CCGT 0602...	A 0608H SCLCR/L 06	8	6	4	100	21,5	8	85,25
	CCMT/CCGT 0602...	A 0810J SCLCR/L 06	10	8	6	110	27	11	85,25
	CCMT/CCGT 0602...	A 1012K SCLCR/L 06	12	10	7	125	32,5	13	85,25
	CCMT/CCGT 0602...	A 1216M SCLCR/L 06	16	12	9	150	42	16	85,25

ERSATZTEILE / SPARE PARTS

Für Artikelnummer For Article Number	Spannschraube Clamping Screw
A 0608H SCLCR/L 06	SW-SS-16 / € 7,15
A 0810J SCLCR/L 06	
A 1012K SCLCR/L 06	
A 1216M SCLCR/L 06	

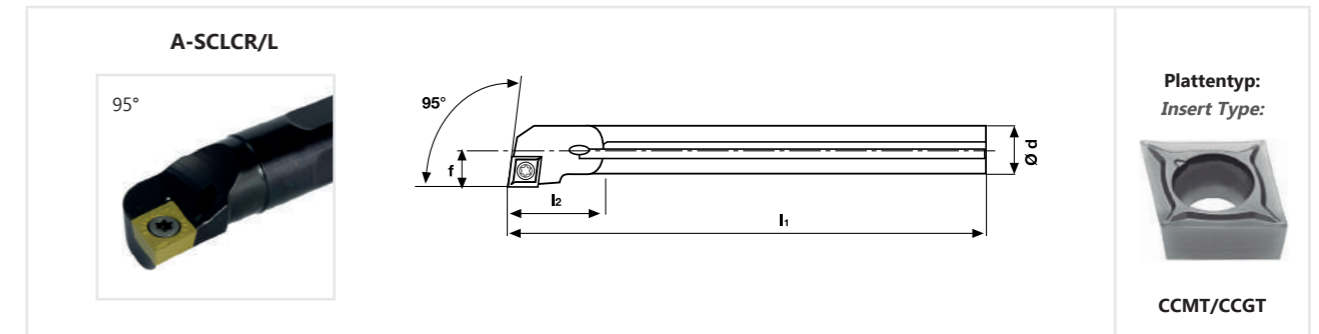

Plattentyp:  
Insert Type:  
  
CCMT/CCGT

STAHL/STEEL	Plattengröße Insert Size	Bestellcode Ordering Code	Maße (mm) Dimensions (mm)					Preis in € Price in €
			d	l <sub>1</sub>	l <sub>2</sub>	f	D min	
	CCMT/CCGT 0602...	A 08H SCLCR/L 06	8	100	12	6	11	85,25
	CCMT/CCGT 0602...	A 10K SCLCR/L 06	10	125	16	7	13	85,25
	CCMT/CCGT 0602...	A 12L SCLCR/L 06	12	140	20	9	18	85,25
	CCMT/CCGT 0913...	A 16Q SCLCR/L 09	16	180	25	11	21	99,00
	CCMT/CCGT 0913...	A 20R SCLCR/L 09	20	200	32	13	26	110,00
	CCMT/CCGT 1204...	A 25R SCLCR/L 12	25	200	40	17	26	139,70
	CCMT/CCGT 1204...	A 32S SCLCR/L 12	32	250	22	20	40	225,50
	CCMT/CCGT 1204...	A 40T SCLCR/L 12	40	300	22	25	50	280,50

ERSATZTEILE / SPARE PARTS

Für Artikelnummer For Article Number	Unterlegplatte Anvil	Spannschraube U-Platte Anvil Screw	Spannschraube Clamping Screw
A 08H SCLCR/L 06			SW-SS-16 / € 7,15
A 10K SCLCR/L 06			
A 12L SCLCR/L 06			
A 16Q SCLCR/L 09			SW-SS-17 / € 4,95
A 20R SCLCR/L 09			SW-SS-18 / € 5,50
A 25R SCLCR/L 12			
A 32S SCLCR/L 12			SW-SS-11 / € 6,05
A 40T SCLCR/L 12	SW-UP15 / € 20,90	SW-GB-2 / € 8,25	

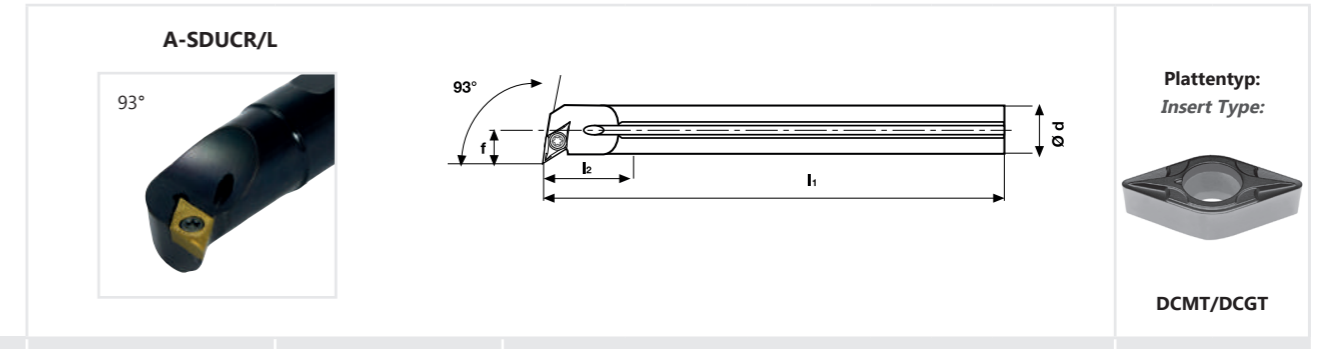
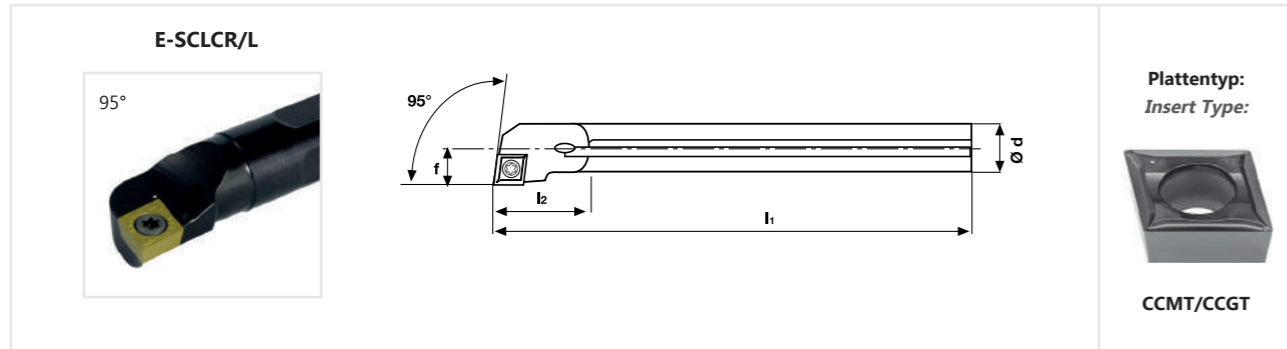

VHM / CARBIDE	Plattengröße Insert Size	Bestellcode Ordering Code	Maße (mm) Dimensions (mm)					Preis in € Price in €
			d	l <sub>1</sub>	l <sub>2</sub>	f	D min	
	CCMT/CCGT 0602...	E 08K SCLCR/L 06		8	125	10	5	10
CCMT/CCGT 0602...	E 10K SCLCR/L 06		10	125	10	6	12	201,85
CCMT/CCGT 0602...	E 12M SCLCR/L 06		12	150	10	7	14	223,30
CCMT/CCGT 0913...	E 16R SCLCR/L 09		16	200	16	9	18	391,05
CCMT/CCGT 0913...	E 20S SCLCR/L 09		20	250	16	11,5	23	848,65
CCMT/CCGT 1204...	E 25S SCLCR/L 12		25	250	16	16	30	1281,50
CCMT/CCGT 1204...	E 32U SCLCR/L 12		32	350	20	22	40	2200,00

STAHL / STEEL	Plattengröße Insert Size	Bestellcode Ordering Code	Maße (mm) Dimensions (mm)					Preis in € Price in €
			d	l <sub>1</sub>	l <sub>2</sub>	f	D min	
	DCMT/DCGT 0702...	A 10H SDUCR/L 07		10	100	16	7	14
DCMT/DCGT 0702...	A 12L SDUCR/L 07		12	140	20	9	17	85,25
DCMT/DCGT 0702...	A 16Q SDUCR/L 07		16	180	25	11	21	99,00
DCMT/DCGT 11T3...	A 20R SDUCR/L 11		20	200	32	13	26	110,00
DCMT/DCGT 11T3...	A 25R SDUCR/L 11		25	200	40	17	33	139,70
DCMT/DCGT 11T3...	A 32S SDUCR/L 11		32	250	50	20	40	225,50
DCMT/DCGT 11T3...	A 40T SDUCR/L 11		40	300	50	25	50	280,50

ERSATZTEILE / SPARE PARTS

Für Artikelnummer For Article Number	Unterlegplatte Anvil	Spannschraube U-Platte Anvil Screw	Spannschraube Clamping Screw
E 08K SCLCR/L 06			SW-SS-16 / € 7,15
E 10K SCLCR/L 06			
E 12M SCLCR/L 06			
E 16R SCLCR/L 09			SW-SS-17 / € 4,95
E 20S SCLCR/L 09			
E 25S SCLCR/L 12			SW-SS-18 / € 5,50
E 32U SCLCR/L 12	SW-UP15 / € 20,90	SW-GB-2 / € 8,25	SW-SS-11 / € 6,05

ERSATZTEILE / SPARE PARTS

Für Artikelnummer For Article Number	Unterlegplatte Anvil	Spannschraube U-Platte Anvil Screw	Spannschraube Clamping Screw
A 10H SDUCR/L 07			SW-SS-16 / € 7,15
A 12L SDUCR/L 07			
A 16Q SDUCR/L 07			
A 20R SDUCR/L 11			SW-SS-17 / € 4,95
A 25R SDUCR/L 11			
A 32S SDUCR/L 11			SW-SS-10 / € 6,05
A 40T SDUCR/L 11	SW-UP16 / € 12,65	SW-GB-1 / € 8,25	

E-SDUCR/L

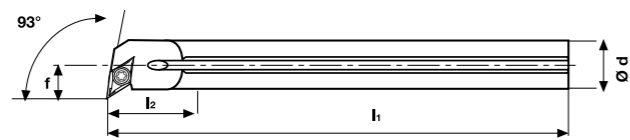

Plattentyp:  
Insert Type:



DCMT/DCGT

VHM / CARBIDE	Plattengröße Insert Size	Bestellcode Ordering Code	Maße (mm) Dimensions (mm)					Preis in € Price in €
			d	l <sub>1</sub>	l <sub>2</sub>	f	D min	
	DCMT/DCGT 0702...	E 08K SDUCR/L 07	8	125	10	7,5	12,5	213,40
	DCMT/DCGT 0702...	E 10K SDUCR/L 07	10	125	10	7,5	14	213,40
	DCMT/DCGT 0702...	E 12M SDUCR/L 07	12	150	12,5	7,5	16	237,05
	DCMT/DCGT 0702...	E 16R SDUCR/L 07	16	200	16,5	9,5	20	391,05
	DCMT/DCGT 11T3...	E 20S SDUCR/L 11	20	250	20,5	13,75	26	848,65
	DCMT/DCGT 11T3...	E 25S SDUCR/L 11	25	250	26	16	32	1281,50

ERSATZTEILE / SPARE PARTS

Für Artikelnummer For Article Number	Spannschraube Clamping Screw
E 08K SDUCR/L 07	SW-SS-16 / € 7,15
E 10K SDUCR/L 07	
E 12M SDUCR/L 07	
E 16R SDUCR/L 07	
E 20S SDUCR/L 11	SW-SS-17 / € 4,95
E 25S SDUCR/L 11	

A-SDQCR/L

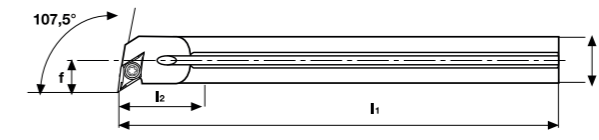

Plattentyp:  
Insert Type:



DCMT/DCGT

STAHL / STEEL	Plattengröße Insert Size	Bestellcode Ordering Code	Maße (mm) Dimensions (mm)					Preis in € Price in €
			d	l <sub>1</sub>	l <sub>2</sub>	f	D min	
	DCMT/DCGT 0702...	A 10H SDQCR/L 07	10	100	16	7	14	85,25
	DCMT/DCGT 0702...	A 12K SDQCR/L 07	12	125	20	9	18	85,25
	DCMT/DCGT 0702...	A 16M SDQCR/L 07	16	150	25	11	22	99,00
	DCMT/DCGT 11T3...	A 20R SDQCR/L 11	20	200	32	13	26	110,00
	DCMT/DCGT 11T3...	A 25R SDQCR/L 11	25	200	40	17	32,5	139,70
	DCMT/DCGT 11T3...	A 32S SDQCR/L 11	32	250	33,5	22	44	225,50
	DCMT/DCGT 11T3...	A 40T SDQCR/L 11	40	300	50	27	52	280,50

ERSATZTEILE / SPARE PARTS

Für Artikelnummer For Article Number	Unterlegplatte Anvil	Spannschraube U-Platte Anvil Screw	Spannschraube Clamping Screw
A 10H SDQCR/L 07			SW-SS-16 / € 7,15
A 12K SDQCR/L 07			
A 16M SDQCR/L 07			
A 20R SDQCR/L 11			SW-SS-17 / € 4,95
A 25R SDQCR/L 11	SW-UP16 / € 12,65	SW-GB-1 / € 8,25	SW-SS-10 / € 6,05
A 32S SDQCR/L 11			
A 40T SDQCR/L 11			

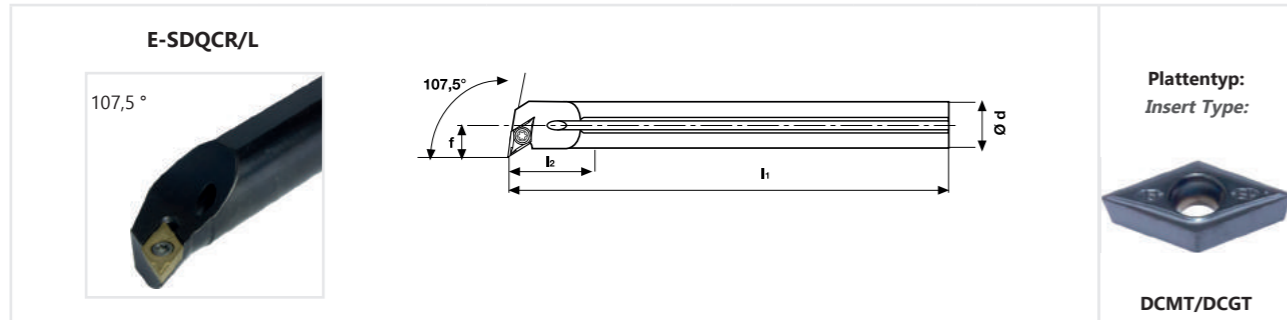

Plattentyp:  
Insert Type:  
  
DCMT/DCGT

VHM / CARBIDE	Plattengröße Insert Size	Bestellcode Ordering Code	Maße (mm) Dimensions (mm)					Preis in € Price in €
			d	l <sub>1</sub>	l <sub>2</sub>	f	D min	
	DCMT/DCGT 0702...	E 08K SDQCR/L 07	8	125	10	7	12	213,40
	DCMT/DCGT 0702...	E 10K SDQCR/L 07	10	125	10	7	13	213,40
	DCMT/DCGT 0702...	E 12M SDQCR/L 07	12	150	12,5	8,5	16	237,05
	DCMT/DCGT 0702...	E 16R SDQCR/L 07	16	200	16,5	10	20	391,05
	DCMT/DCGT 11T3...	E 20S SDQCR/L 11	20	250	13	12,5	25	848,65
	DCMT/DCGT 11T3...	E 25S SDQCR/L 11	25	250	17	16	32	1281,50

ERSATZTEILE / SPARE PARTS

Für Artikelnummer For Article Number	Spannschraube Clamping Screw
E 08K SDQCR/L 07	SW-SS-16 / € 7,15
E 10K SDQCR/L 07	
E 12M SDQCR/L 07	
E 16R SDQCR/L 07	
E 20S SDQCR/L 11	SW-SS-17 / € 4,95
E 25S SDQCR/L 11	

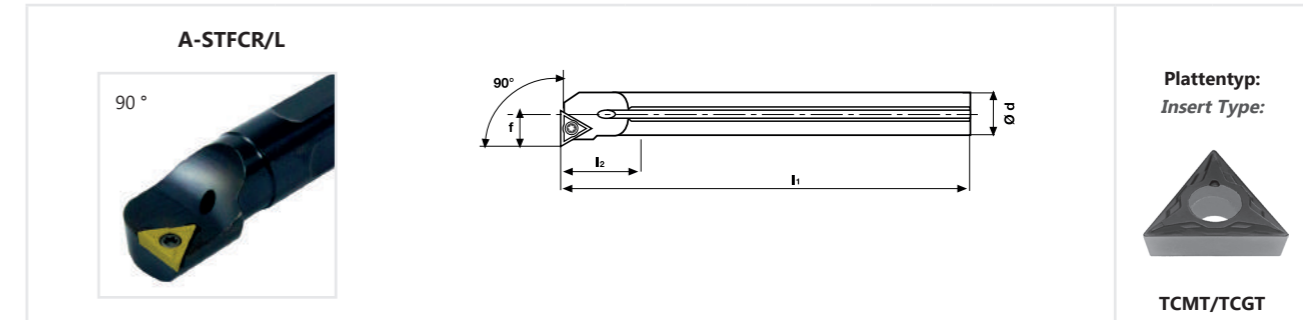

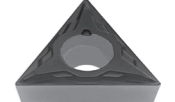
Plattentyp:  
Insert Type:  
  
TCMT/TCGT

STAHL / STEEL	Plattengröße Insert Size	Bestellcode Ordering Code	Maße (mm) Dimensions (mm)					Preis in € Price in €
			d	l <sub>1</sub>	l <sub>2</sub>	f	D min	
	TCMT/TCGT 1102...	A 10K STFCR/L 11	10	125	16	7	14	85,25
	TCMT/TCGT 1102...	A 12L STFCR/L 11	12	140	20	9	17	85,25
	TCMT/TCGT 1102...	A 16Q STFCR/L 11	16	180	25	11	21	96,80
	TCMT/TCGT 16T3...	A 20R STFCR/L 16	20	200	32	13	27	107,80
	TCMT/TCGT 16T3...	A 25R STFCR/L 16	25	200	40	17	33	136,40
	TCMT/TCGT 16T3...	A 32S STFCR/L 16	32	250	21	22	40	222,20
	TCMT/TCGT 16T3...	A 40T STFCR/L 16	40	300	21	27	49	280,50

ERSATZTEILE / SPARE PARTS

Für Artikelnummer For Article Number	Unterlegplatte Anvil	Spannschraube U-Platte Anvil Screw	Spannschraube Clamping Screw
A 10K STFCR/L 11			SW-SS-16 / € 7,15
A 12L STFCR/L 11			
A 16Q STFCR/L 11			
A 20R STFCR/L 16			SW-SS-17 / € 4,95
A 25R STFCR/L 16			
A 32S STFCR/L 16	SW-UP21 / € 12,65	SW-GB-1 / € 8,25	SW-SS-10 / € 6,05
A 40T STFCR/L 16			



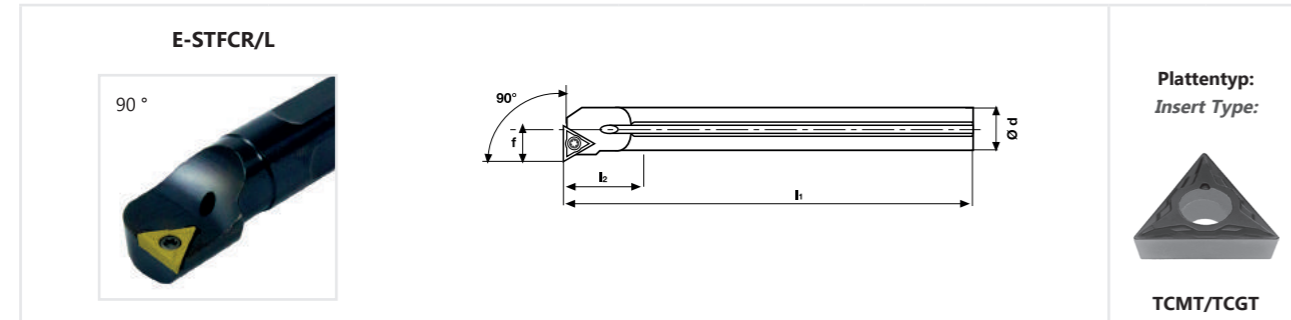

Plattentyp:  
Insert Type:

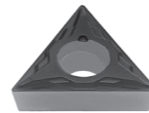

TCMT/TCGT

VHM / CARBIDE	Plattengröße Insert Size	Bestellcode Ordering Code	Maße (mm) Dimensions (mm)					Preis in € Price in €
			d	l <sub>1</sub>	l <sub>2</sub>	f	D min	
	TCMT/TCGT 1102...	E 10K STFCR/L 11	10	125	16	6	12	223,30
	TCMT/TCGT 1102...	E 12M STFCR/L 11	12	125	20	7,5	15	237,05
	TCMT/TCGT 1102...	E 16R STFCR/L 11	16	150	25	9,5	19	391,05
	TCMT/TCGT 16T3...	E 20S STFCR/L 16	20	200	32	12	24	848,65
	TCMT/TCGT 16T3...	E 25S STFCR/L 16	25	250	40	13,5	27	1281,50

ERSATZTEILE / SPARE PARTS

Für Artikelnummer For Article Number	Spannschraube Clamping Screw
E 10K STFCR/L 11	SW-SS-16 / € 7,15
E 12M STFCR/L 11	
E 16R STFCR/L 11	
E 20S STFCR/L 16	SW-SS-17 / € 4,95
E 25S STFCR/L 16	

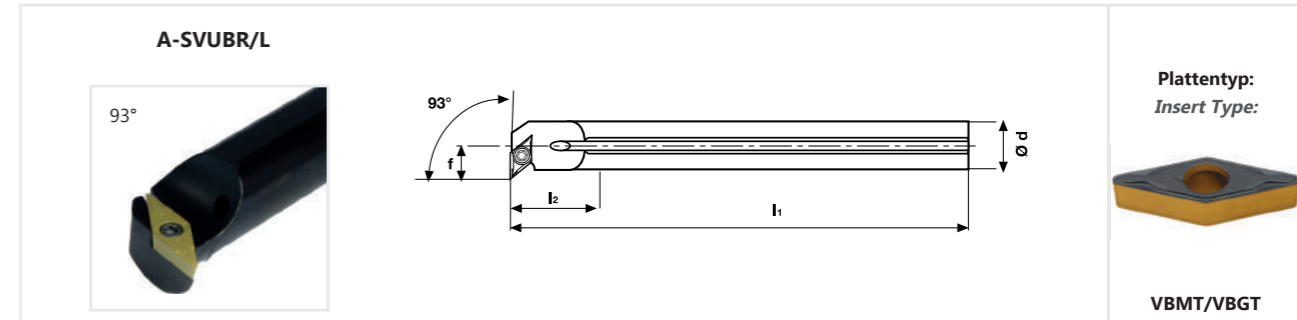

Plattentyp:  
Insert Type:

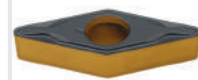

VBMT/VBGT

VHM / CARBIDE	Plattengröße Insert Size	Bestellcode Ordering Code	Maße (mm) Dimensions (mm)					Preis in € Price in €
			d	l <sub>1</sub>	l <sub>2</sub>	f	D min	
	VBMT/VBGT 1103...	A 16M SVUBR/L 11	16	150	16,5	11	21	119,35
	VBMT/VBGT 1103...	A 20R SVUBR/L 11	20	200	20,5	13	25	124,85
	VBMT/VBGT 1604...	A 25R SVUBR/L 16	25	200	25,5	17	31,5	147,40
	VBMT/VBGT 1604...	A 32S SVUBR/L 16	32	250	33,5	22	40	243,65
	VBMT/VBGT 1604...	A 40T SVUBR/L 16	40	300	40	27	49	294,80

ERSATZTEILE / SPARE PARTS

Für Artikelnummer For Article Number	Unterlegplatte Anvil	Spannschraube U-Platte Anvil Screw	Spannschraube Clamping Screw
A 16M SVUBR/L 11			SW-SS-16 / € 7,15
A 20R SVUBR/L 11			
A 25R SVUBR/L 16			
A 32S SVUBR/L 16	SW-UP22 / € 17,05	SW-GB-1 / € 8,25	-
A 40T SVUBR/L 16			SW-SS-10 / € 6,05

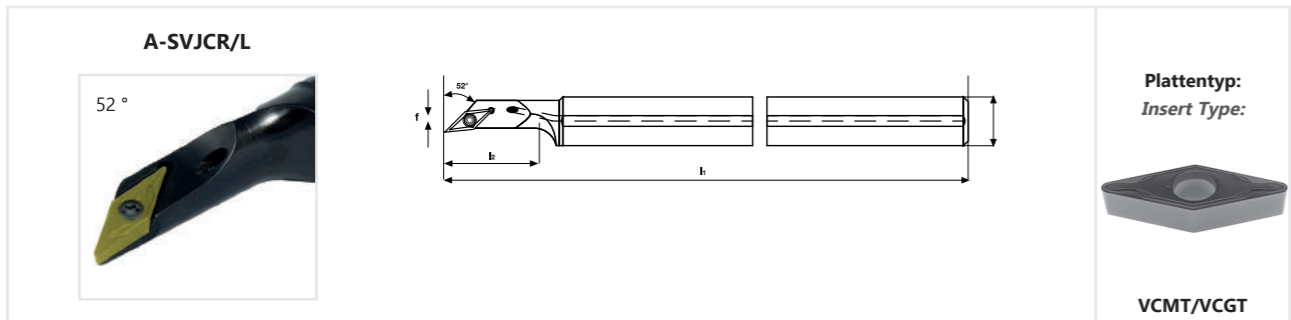

Plattentyp:  
Insert Type:



VCMT/VCGT

STAHL / STEEL	Plattengröße Insert Size	Bestellcode Ordering Code	Maße (mm) Dimensions (mm)					Preis in € Price in €
			d	l <sub>1</sub>	l <sub>2</sub>	f	D min	
	VCMT/VCGT 0702...	A10K SVJCR/L 07	10	125	18	1,5	-	119,35
	VCMT/VCGT 0702...	A12L SVJCR/L 07	12	140	18	2,0	-	119,35
	VCMT/VCGT 1103...	A16M SVJCR/L 11	16	150	30	4,6	22	119,35
	VCMT/VCGT 1103...	A20Q SVJCR/L 11	20	180	38	4,6	24	124,85
	VCMT/VCGT 1604...	A25R SVJCR/L 16	25	200	44	4,6	28	147,40

ERSATZTEILE / SPARE PARTS

Für Artikelnummer For Article Number	Spannschraube Clamping Screw
A10K SVJCR/L 07	SW-SS-15 / € 8,25
A12L SVJCR/L 07	
A16M SVJCR/L 11	SW-SS-16 / € 7,15
A20Q SVJCR/L 11	
A25R SVJCR/L 16	SW-SS-17 / € 4,95

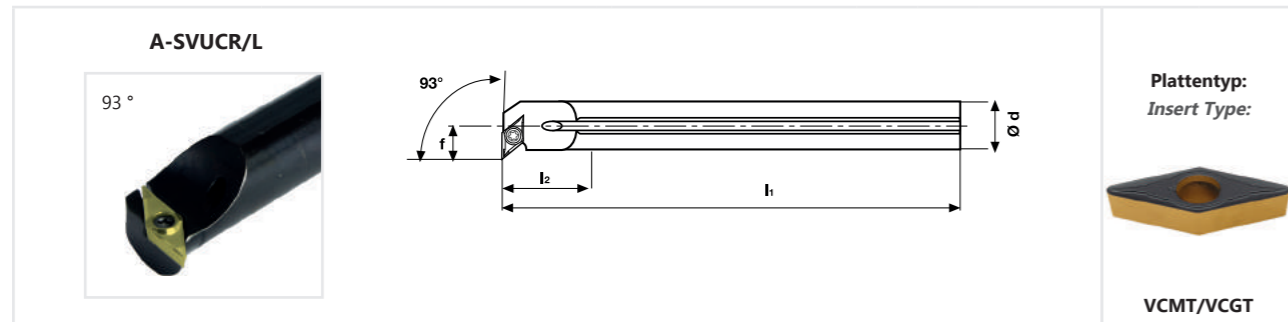

Plattentyp:  
Insert Type:  
**VCMT/VCMT**

STAHL / STEEL	Plattengröße Insert Size	Bestellcode Ordering Code	Maße (mm) Dimensions (mm)					Preis in € Price in €
			d	l <sub>1</sub>	l <sub>2</sub>	f	D min	
	VCMT/VCMT 1103...	A 16M SVUCR/L 11	16	150	16,5	11	21	119,35
	VCMT/VCMT 1103....	A 20R SVUCR/L 11	20	200	20,5	13	25	124,85
	VCMT/VCMT 1604...	A 25R SVUCR/L 16	25	200	20,5	17	31,5	147,40
	VCMT/VCMT 1604...	A 32S SVUCR/L 16	32	250	33,5	22	40	243,65
	VCMT/VCMT 1604...	A 40T SVUCR/L 16	40	300	40	27	49	294,80

ERSATZTEILE / SPARE PARTS

Für Artikelnummer For Article Number	Unterlegplatte Anvil	Spannschraube U-Platte Anvil Screw	Spannschraube Clamping Screw
A 16M SVUCR/L 11			SW-SS-16 / € 7,15
A 20R SVUCR/L 11			
A 25R SVUCR/L 16			SW-SS-17 / € 4,95
A 32S SVUCR/L 16			
A 40T SVUCR/L 16	SW-UP22 / € 17,05	SW-GB-1 / € 8,25	SW-SS-10 / € 6,05

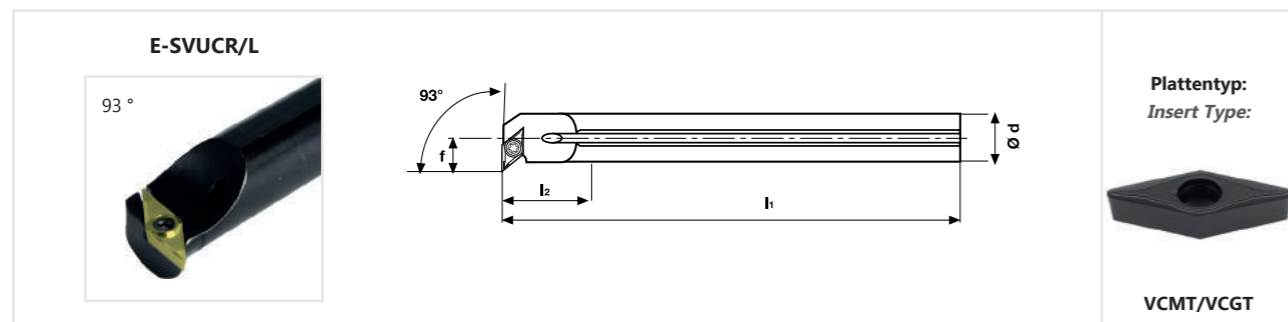

Plattentyp:  
Insert Type:  
**VCMT/VCMT**

VHM / CARBIDE	Plattengröße Insert Size	Bestellcode Ordering Code	Maße (mm) Dimensions (mm)					Preis in € Price in €
			d	l <sub>1</sub>	l <sub>2</sub>	f	D min	
	VCMT/VCMT... 1103...	E 16R SVUCR/L 11	16	200	16,5	11	21	391,05
	VCMT/VCMT... 1103....	E 20S SVUCR/L 11	20	250	20,5	13	25	848,65
	VCMT/VCMT... 1103...	E 25S SVUCR/L 11	25	250	25,5	17	31,5	1298,00

ERSATZTEILE / SPARE PARTS

Für Artikelnummer For Article Number	Spannschraube Clamping Screw
A 16M SVUCR/L 11	SW-SS-16 / € 7,15
A 20R SVUCR/L 11	
A 25R SVUCR/L 16	

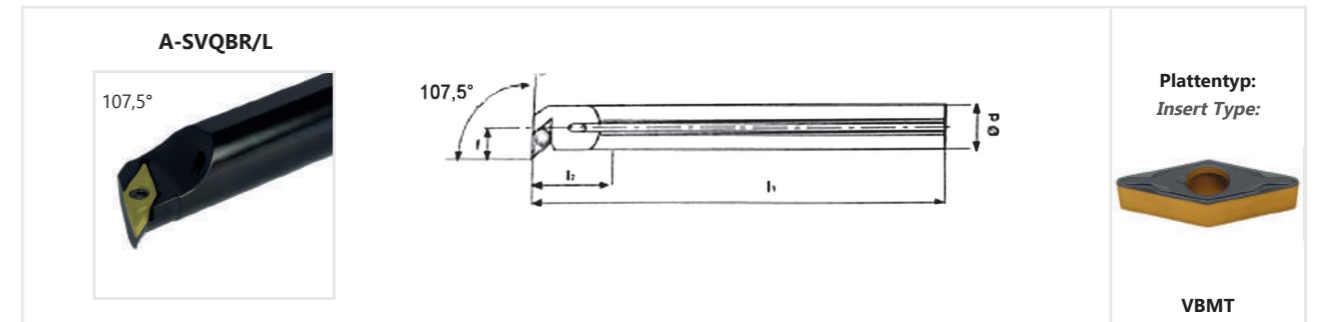

Plattentyp:  
Insert Type:  
**VBMT**

STAHL / STEEL	Plattengröße Insert Size	Bestellcode Ordering Code	Maße (mm) Dimensions (mm)					Preis in € Price in €
			d	l <sub>1</sub>	l <sub>2</sub>	f	D min	
	VBMT 1103...	A 16M SVQBR/L 11	16	150	16,5	11	21	119,35
	VBMT 1103...	A 20R SVQBR/L 11	20	200	20,5	13	25	124,85
	VBMT 1103...	A 25R SVQBR/L16	25	200	40	17	32	147,40

ERSATZTEILE / SPARE PARTS

Für Artikelnummer For Article Number	Spannschraube Clamping Screw
A 16M SVQBR/L 11	SW-SS-12 / € 6,05
A 20R SVQBR/L 11	
A 25R SVQBR/L16	SW-SS-10 / € 6,05

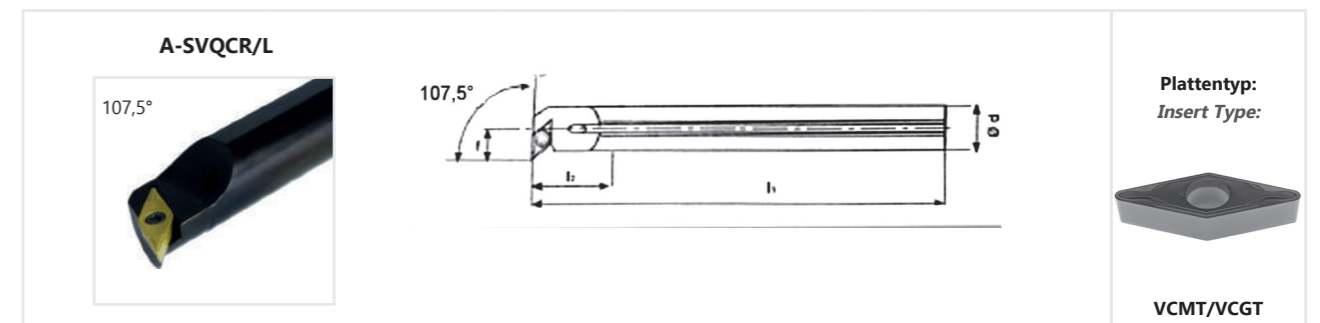

Plattentyp:  
Insert Type:  
**VCMT/VCMT**

VHM / CARBIDE	Plattengröße Insert Size	Bestellcode Ordering Code	Maße (mm) Dimensions (mm)					Preis in € Price in €
			d	l <sub>1</sub>	l <sub>2</sub>	f	D min	
	VCMT/VCMT... 1103...	A 16M SVQCR/L 11	16	150	16,5	11	21	119,35
	VCMT/VCMT... 1103....	A 20R SVQCR/L 11	20	200	20,5	13	25	124,85
	VCMT/VCMT... 1604...	A 25R SVQCR/L 16	25	200	40	17	32	147,40
	VCMT/VCMT... 1604...	A 32S SVQCR/L 16	32	250	33,5	22	40	243,65
	VCMT/VCMT... 1604...	A 40T SVQCR/L 16	40	300	40	27	49	294,80

ERSATZTEILE / SPARE PARTS

Für Artikelnummer For Article Number	Unterlegplatte Anvil	Spannschraube U-Platte Anvil Screw	Spannschraube Clamping Screw
A 16M SVQCR/L 11			SW-SS-16 / € 7,15
A 20R SVQCR/L 11			
A 25R SVQCR/L 16			
A 32S SVQCR/L 16			SW-SS-10 / € 6,05
A 40T SVQCR/L 16	SW-UP22 / € 17,05	SW-GB-1 / € 8,25	

**PCLNR/L**

95°

Plattentyp:  
Insert Type:

CN...

Plattengröße Insert Size	Bestellcode Ordering Code	Maße (mm) Dimensions (mm)							Preis in € Price in €
		d	h <sub>1</sub>	h <sub>2</sub>	l <sub>1</sub>	l <sub>2</sub>	f	D	
CN... 0903...	A16M PCLNR/L 09	12	8	15,5	150	21	11	20	165,55
CN... 0903...	A20Q PCLNR/L 09	16	10	19	180	21	13	25	198,00
CN... 1204...	A25R PCLNR/L 12	25	12,5	24	200	21	17	32	253,00
CN... 1204...	A32S PCLNR/L 12	32	16	31	250	24,1	22	40	280,50
CN... 1204...	A40T PCLNR/L 12	40	20	38,5	300	24,1	27	49	324,50

ERSATZTEILE / SPARE PARTS

Für Artikelnummer For Article Number	Unterlegplatte Anvil	Hebel Lever	Spannschraube Clamping Screw	Rohrstift Shim Pin	Montagedorn Shim Pin Punch
A16M PCLNR/L 09	-	SW-KH-2 / € 22,00	SW-SS-3 / € 5,50	-	-
A20Q PCLNR/L 09	-	SW-KH-2 / € 22,00	SW-SS-3 / € 5,50	-	-
A25R PCLNR/L 12	SW-UP3 / € 11,00	SW-KH-8 / € 22,00	SW-SS-6 / € 5,50	SW-RS-5 / € 3,85	SW-MD-4 / € 2,20
A32S PCLNR/L 12	SW-UP2 / € 13,75	SW-KH-2 / € 22,00	SW-SS-2 / € 7,15	SW-RS-2 / € 3,85	SW-MD-4 / € 2,20
A40T PCLNR/L 12	SW-UP2 / € 13,75	SW-KH-2 / € 22,00	SW-SS-6 / € 5,50	SW-RS-2 / € 3,85	SW-MD-4 / € 2,20

**PDUNR/L**

93°

Plattentyp:  
Insert Type:

DN...

Plattengröße Insert Size	Bestellcode Ordering Code	Maße (mm) Dimensions (mm)							Preis in € Price in €
		d	h <sub>1</sub>	h <sub>2</sub>	l <sub>1</sub>	f	D		
DN... 1104...	A20Q PDUNR/L 11	20	10	19	180	16	27	203,50	
DN... 1104...	A25R PDUNR/L 11	25	12,5	24	200	18,5	32	247,50	
DN... 1506....	A32S PDUNR/L 15	32	16	31	250	22	40	277,75	
DN... 1506.....	A40T PDUNR/L 15	40	20	38,5	300	27	49	324,50	

ERSATZTEILE / SPARE PARTS

Bestellcode Ordering Code	Unterlage Support Pad	Hebel Lever	Spannschraube Clamping Screw	Rohrstift Shim Pin	Montagedorn Shim Pin Punch
...20... PDUN R/L 11	-	SW-KH-6 / € 29,70	SW-SS-7 / € 5,50	-	-
...25... PDUN R/L 11	SW-UP6 / € 13,75	SW-KH-5 / € 22,00	SW-SS-6 / € 5,50	SW-RS-5 / € 3,85	SW-MD-4 / € 2,20
...32-40... PDUN R/L 15	SW-UP7 / € 14,30	SW-KH-7 / € 23,65	SW-SS-6 / € 5,50	SW-RS-2 / € 3,85	SW-MD-4 / € 2,20

**PTFNR/L**

90°

Plattentyp:  
Insert Type:

TN...

Plattengröße Insert Size	Bestellcode Ordering Code	Maße (mm) Dimensions (mm)							Preis in € Price in €
		d	h <sub>1</sub>	h <sub>2</sub>	l <sub>1</sub>	l <sub>2</sub>	f	D	
TN... 1103...	A20Q PTFNR/L 11	20	10	19	180	14	13	25	203,50
TN... 1604...	A25R PTFNR/L 16	25	12,5	24	200	17,5	17	32	247,50

ERSATZTEILE / SPARE PARTS

Für Artikelnummer For Article Number	Unterlegplatte Anvil	Hebel Lever	Spannschraube Clamping Screw	Rohrstift Shim Pin	Montagedorn Shim Pin Punch
A20Q PTFNR/L 11	-	SW-KH-10 / € 20,70	SW-SS-9 / € 5,50	-	-
A25R PTFNR/L 16	SW-UP11 / € 11,00	SW-KH-8 / € 20,70	SW-SS-6 / € 5,50	SW-RS-5 / € 4,40	SW-MD-4 / € 2,20

**PWLNRL/L**

95°

Plattentyp:  
Insert Type:

WN...

Plattengröße Insert Size	Bestellcode Ordering Code	Maße (mm) Dimensions (mm)							Preis in € Price in €
		d	h <sub>1</sub>	h <sub>2</sub>	l <sub>1</sub>	l <sub>2</sub>	f	D	
WN... 0604...	A16M PWLNRL/L 06	16	15,5	150	17,5	11	21	25	165,55
WN... 0604...	A20Q PWLNRL/L 06	20	19	180	19,5	13	25	32	203,50
WN... 0604...	A25R PWLNRL/L 06	25	24	200	19,5	17	32	25	247,50
WN... 0804...	A32S PWLNRL/L 08	32	31	250	26	22	40	32	277,75

ERSATZTEILE / SPARE PARTS

Für Artikelnummer For Article Number	Unterlegplatte Anvil	Hebel Lever	Spannschraube Clamping Screw	Rohrstift Shim Pin	Montagedorn Shim Pin Punch
A16M PWLNRL/L 06	-	SW-KH-9 / € 22,00	SW-SS-8 / € 5,50	-	-
A20Q PWLNRL/L 06	-	SW-KH-9 / € 22,00	SW-SS-8 / € 5,50	-	-
A25R PWLNRL/L 06	SW-UP13 / € 16,50	SW-KH-8 / € 22,00	SW-SS-6 / € 5,50	SW-RS-5 / € 3,85	SW-MD-4 / € 2,20
A32S PWLNRL/L 08	SW-UP13 / € 16,50	SW-KH-2 / € 22,00	SW-SS-6 / € 5,50	SW-RS-2 / € 3,85	SW-MD-4 / € 2,20