

Kesici Uç ve Bağlama Sistemleri
Cutting Inserts and Connection Systems
Trägerwerkzeuge für Wendeschneidplatten

2020

www.akko.com.tr



 **AKKO**[®]



konuşulan
the spoken kalite...
quality...





TS EN ISO 9001:2015





1986 yılında Abdullah KARAKUŞ tarafından kurulan AKKO Oto. Mak. Hırd. San. Tic. Ltd. Şti. Tornalama Takımları, Diş ve Kanal Açma Takımları, Delik Delme Takımları, Frezeleme Takımları ve Özel Takımları üretmektedir. Şu an 8000 m²' ye yakın bir alanda Türkiye, Japonya, Almanya, İsviçre gibi ülkelerin ürettikleri son teknoloji tezgah ve ekipmanlarıyla yıllık 300.000 adet üretim kapasitesiyle, standart 7000 çeşit takım üretimi yapmaktadır. Avrupa, Asya, Afrika, Güney Amerika ve Orta Doğu'da şimdilik 70 ülkeye ürün sevkiyatına devam etmekte olup 200.000 adet civarında üretilmiş ürün stoklarında mevcuttur. Firmaya, özel üretilen çelik hammadde işleme girer ve bütün üretim süreci bünyesinde gerçekleşir. Çeliğin işlenmesi, ısıl işlemi, üzerindeki kaplama ve her türlü üretim süreci bir entegre tesis olan AKKO'da gerçekleşir.

We as AKKO Oto. Mak. Hırd. San. Tic. Ltd. Şti, which has been founded by Abdullah KARAKUŞ in 1986, produce Turning Tool Holders, Threading and Grooving Tool Holders, U-Drills, Milling Tool Holders and Precision Tool Holders (OEM Tool Holders). We produce standard 7000 kinds of tool holders with production capacity of 300.000 pieces per annum in an area about 8000 square meter. We are going on exporting 70 countries including European, Asian, African, Asian, South American Countries and Middle East Countries. We keep ready about 200.000 pieces produced products in our stock. Steel Raw materials that we make produced especially for us are delivered our factory and all production process are made in our factory. All kind of process from machining of steel to heat treatment and coating on our tools are made in our integrated factory AKKO.



Die Fa. Akko wurde 1986 von Abdullah Karakuş gegründet und produziert Dreh-, Gewinde- und Stechwerkzeuge für Wendeschneidplatten. Ebenso gehören Wendeplattenbohrer, Wendeplattenfräser und Sonderwerkzeuge für Wendeplatten zum Lieferprogramm. Alle Werkzeuge sind auch als OEM-Version lieferbar. Wir fertigen 7000 verschiedene Standardartikel auf einer Fläche von 8000 Quadratmetern. Unsere jährliche Produktionsmenge beträgt ca. 300000 Stück. Wir exportieren in 71 verschiedene Länder in Europa, Asien, Afrika, Südamerika und Mittlerer Osten. Unsere Lagerkapazität beträgt ca. 200000 Stück. Das eingesetzte Rohmaterial wird speziell für unsere Firma produziert. Alle weiteren Produktionsschritte wie z.B. mechanische Bearbeitung, Wärmebehandlung und Beschichtung unserer Werkzeuge erfolgen auf unseren eigenen Maschinenanlagen.

S11-S12 S13-S14 S15-S19 S20-S23 S24-S27	KESİCİ UÇLAR ve TAKIMLARI POLY-V KANAL AÇMA UÇLARI ve TAKIMLARI KANAL AÇMA, KÖŞE BOŞALTMA UÇLARI ve TAKIMLARI BROŞ ÇEKME UÇLARI ve TAKIMLARI SUPAP YUVASI İŞLEME UÇLARI ve TAKIMLARI WHIRLING UÇLARI ve TAKIMLARI
---	---

S29 S30-S39 S40-S42 S43-S50 S51-S57 S58-S71 S71-S76 S75-S77	DIŞ TORNA TAKIMLARI DIŞ TORNA KATERLERİ KODLAMA SİSTEMİ T-SİSTEM DIŞ TORNA KATERLERİ M-SİSTEM DIŞ TORNA KATERLERİ P-SİSTEM DIŞ TORNA KATERLERİ C-SİSTEM DIŞ TORNA KATERLERİ S-SİSTEM DIŞ TORNA KATERLERİ S-SİSTEM İSVİÇRE TİPİ KAYAR OTOMAT MAKİNA TAKIMLARI SEC TOOLS
--	---

S78 S79-S84 S85-S89 S90-S95 S96-S111	DELİK TORNA TAKIMLARI DELİK TORNA KATERLERİ KODLAMA SİSTEMİ T&C SİSTEM DELİK TORNA KATERLERİ M-SİSTEM DELİK TORNA KATERLERİ P-SİSTEM DELİK TORNA KATERLERİ S-SİSTEM DELİK TORNA KATERLERİ
--	---

S113 S114-S115 S116-S118 S119-S121	KARTUŞLAR KARTUŞLARIN KODLAMA SİSTEMİ S-TİP REKTEFİYE KARTUŞLARI S-SİSTEM KARTUŞLAR P-SİSTEM KARTUŞLAR VE BORU PAHLAMA TAKIMLARI
---	---

S123 S124-S129	DIŞ AÇMA TAKIMLARI DIŞ AÇMA KATERLERİ KODLAMA SİSTEMİ DIŞ AÇMA KATERLERİ ve TEKNİK BİLGİ
-------------------	---

S131 S132-S144 S144-S146 S147-S149 S149 S150-S151 S151 S152-S161	KANAL AÇMA TAKIMLARI KANAL KATERLERİ KODLAMA SİSTEMİ DIŞ ÇAP KANAL AÇMA TAKIMLARI DIŞ ÇAP KANAL AÇMA İSVEÇ TİPİ KAYAR OTOMAT MAKİNA TAKIMLARI DIŞ ÇAP ALIN KANAL AÇMA TAKIMLARI L TİP ALIN KANAL AÇMA TAKIMLARI KESME VE DERİN KANAL AÇMA LAMALARI KESME VE DERİN KANAL AÇMA LAMA BLOĞU DELİK İÇİ KANAL KATERLERİ
---	--

S165-S188 S189-S190 S191 S192 S195-S196 S198-S202	DELİK DELME ve İŞLEME TAKIMLARI TAKMA UÇLU MATKAPLAR ve KODLAMA SİSTEMİ DELİK PAHLAMA TAKIMI ve MONTAJ ŞEKLİ EKSANTRİK TAKMA UÇLU MATKAP ADAPTÖRÜ ÖZEL DELİK DELME ve İŞLEME TAKIMI SİPARİŞ FORMU EKONOMİK KEŞİCİLER ve KODLAMA SİSTEMİ AYARLI DELİK İŞLEME BARALARI ve KODLAMA SİSTEMİ
--	--

S204 S205-S206 S206 S207 S208-S231 S232-S234 S235-S244 S244-S252 S253-S260 S260-S262 S262-S263 S264 S265-S266 S267 S268-S299 S300-S303 S304-S306 S307-S313 S314-S315 S316-S317 S318-S323	FREZELEME TAKIMLARI FREZELEME TAKIMLARI KODLAMA SİSTEMİ S-SİSTEM PAH FREZELER HELİS PAH FREZELEME TAKIMLARI SİLİNDİRİK ALYAN BAŞLI VİDA (DIN 974-1) HAVŞALARINI AÇMA FREZELERİ S-SİSTEM YÜZEY PARMAK FREZELER S-SİSTEM YÜZEY ve KOPYA PARMAK FREZELER S-SİSTEM HIZLI İLERLEMELİ PARMAK FREZELER S-SİSTEM MODÜLER PARMAK FREZELER S-SİSTEM HIZLI İLERLEMELİ MODÜLER PARMAK FREZELER KÜRE UÇLU PARMAK FREZELER MODÜLER KÜRE UÇLU PARMAK FREZELER VIDALI TAKIM TUTUCULARI DIŞ AÇMA FREZELEME TAKIMLARI S-SİSTEM HELİS FREZELER YÜZEY FREZELER YÜZEY ve KOPYA FREZELER C-SİSTEM YÜZEY FREZELER HIZLI İLERLEMELİ FREZELER T KANAL FREZELER DİSK FREZELER FREZELEME TAKIMLARI MONTAJ ÖLÇÜLERİ ve TEKNİK BİLGİLER
--	--

S324-S337 S338-S339	YEDEK PARÇALAR YEDEK PARÇALAR ÜRÜN GURUPLARINA GÖRE İÇİNDEKİLER
------------------------	--

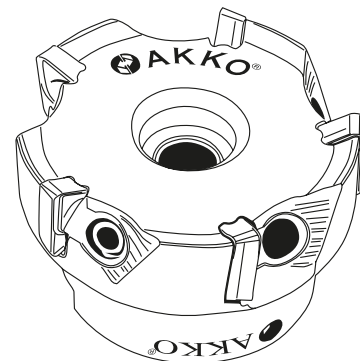
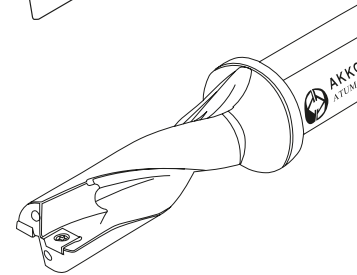
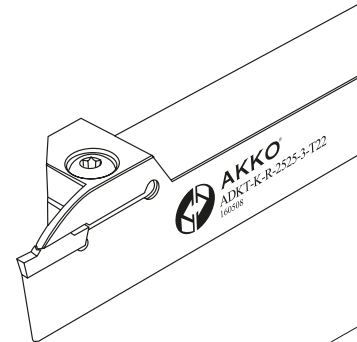
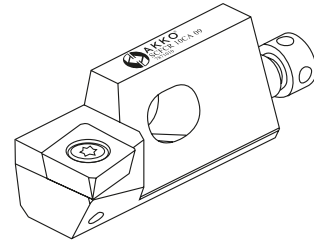
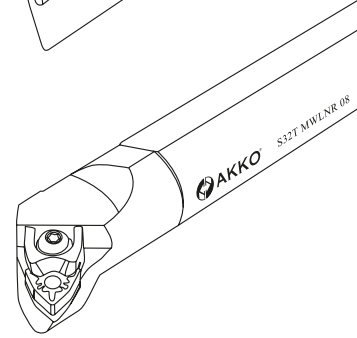
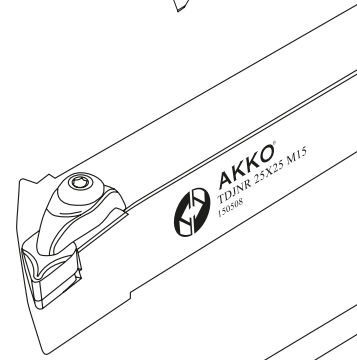
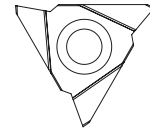

İÇİNDEKİLER

CONTENTS

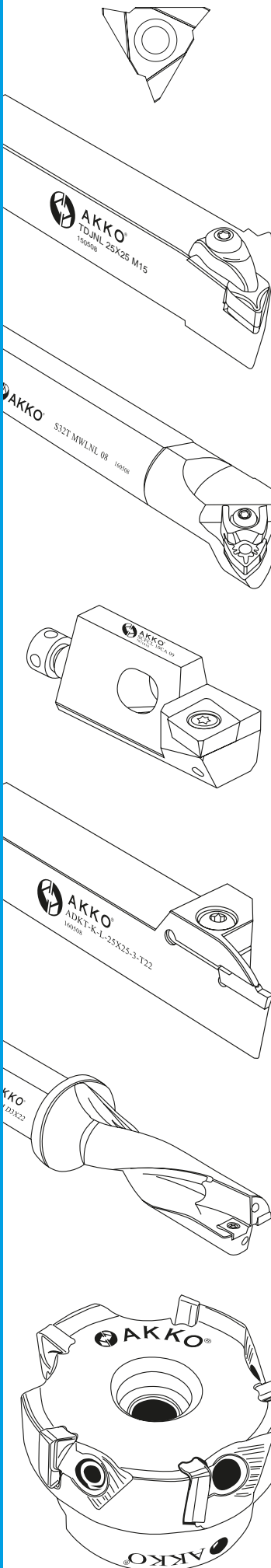

P11-P12
P13-P14
P15-P19
P20-P23
P24-P27

CUTTING INSERTS and TOOLHOLDERS

POLY-V GROOVING INSERTS and TOOLHOLDERS
INSERTS and TOOLHOLDERS FOR GROOVING CORNER RELIEFS
BROACHING INSERTS and TOOLHOLDERS
VALVE SEAT INSERTS and TOOLHOLDERS
WHIRLING INSERTS and TOOLHOLDERS

P29
P30-P39
P40-P42
P43-P50
P51-P57
P58-P71
P71-P76
S75-S77

EXTERNAL TURNING TOOLHOLDERS

EXTERNAL TURNING TOOLHOLDERS DESIGNATION SYSTEM
T-SYSTEM EXTERNAL TURNING TOOLHOLDERS
M-SYSTEM EXTERNAL TURNING TOOLHOLDERS
P-SYSTEM EXTERNAL TURNING TOOLHOLDERS
C-SYSTEM EXTERNAL TURNING TOOLHOLDERS
S-SYSTEM EXTERNAL TURNING TOOLHOLDERS
S-SYSTEM TOOLS FOR SWISS TYPE SLIDING AUTOMATIC LATHES
SEC TOOLS

P78
P79-P84
P85-P89
P90-P95
P96-P111

INTERNAL TURNING TOOLHOLDERS

BORING BARS DESIGNATION SYSTEM
T&C SYSTEM BORING BARS
M-SYSTEM BORING BARS
P-SYSTEM BORING BARS
S-SYSTEM BORING BARS

P113
P114-P115
P116-P118
P119-P121

CARTRIDGE

CARTRIDGE DESIGNATION SYSTEM
S-TYPE ENGINE OVERHAUL CARTRIDGE
S-SYSTEM CARTRIDGE
P-SYSTEM CARTRIDGE AND PIPE BEVELING and CHAMFERING TOOLS

P123
P124-P129

THREADING TOOLHOLDERS

THREADING TOOLHOLDERS DESIGNATION SYSTEM
THREADING TOOLHOLDERS and TECHNICAL INFORMATION

P131
P132-P144
P144-P146
P147-P149
P149
P150-P151
P151
P152-P161

GROOVING TOOLHOLDERS

GROOVING TOOLHOLDERS DESIGNATION SYSTEM
EXTERNAL GROOVING TOOLHOLDERS
EXTERNAL GROOVING TOOLHOLDERS FOR SWISS TYPE SLIDING AUTOMATIC LATHES
FACE EXTERNAL GROOVING TOOLHOLDERS
L TYPE FACE EXTERNAL GROOVING TOOLHOLDERS
BLADES FOR PARTING AND DEEP GROOVING
BLOCKS FOR PARTING AND DEEP GROOVING BLADES
INTERNAL GROOVING TOOLHOLDERS

P165-P188
P189-P190
P191
P192
P195-P196
P198-P202

DRILLING and HOLEMAKING TOOLS

U-DRILL SYSTEM and DESIGNATION SYSTEM
DRILL CHAMFERING RING TOOLS AND MOUNTING SYSTEM
EXCENTRIC ADAPTOR FOR U-DRILLS
SPECIAL DRILL ORDER FORM
ECONOMIC CUTTING TOOLS and DESIGNATION SYSTEM
ADJUSTABLE BORING HEADS and DESIGNATION SYSTEM

P204
P205-P206
P206
P207
P208-P231
P232-P234
P235-P244
P244-P252
P253-P260
P260-P262
P262-P263
P264
P265-P266
P267
P268-P299
P300-P303
P304-P306
P307-P313
P314-P315
P316-P317
P318-P323

MILLING TOOLS

MILLING TOOLS DESIGNATION SYSTEM
S-SYSTEM CHAMFERING END MILLS
HELIX CHAMFER MILLING TOOLS
COUNTERSINK MILLING TOOL FOR CYLINDRICAL ALLEN HEAD SCREWS (DIN 974-1)
S-SYSTEM END MILLS
S-SYSTEM FACE and COPY END MILLS
S-SYSTEM HIGHFEED END MILLS
S-SYSTEM MODULAR END MILLS (SCREW TYPE TOOLS)
S-SYSTEM MODULAR (SCREW TYPE) HIGHFEED END MILLS
BALL NOSE MILLS
BALL NOSE MODULAR (SCREW TYPE) END MILLS
SCREWED TOOL HOLDERS
THREAD MILLING TOOLS
S-SYSTEM HELIX END MILL
FACE MILLING
FACE and COPY MILLING TOOLS
C-SYSTEM FACE MILLING
HIGH FEED MILLING TOOLS
T SLOT MILLING
DISC MILLING
MOUNTING REFERENCE FOR MILLING CUTTERS and TECHNICAL INFORMATION

P324-P337
P338-P339

SPARE PARTS

SPARE PARTS
INDEX

	WENDESCHNEIDPLATTEN und WERKZEUGE
S11-S12	POLY-V EINSTECHPLATTEN UND WERKZEUGE
S13-S14	WENDESCHNEIDPLATTEN UND WERKZEUGE FÜR AXIAL FREISTICHE
S15-S19	WENDESCHNEIDPLATTEN UND WERKZEUGHALTER FÜR DIE NUTBEARBEITUNG
S20-S23	WENDESCHNEIDPLATTEN UND WERKZEUGE FÜR VENTILSITZE
S24-S27	WENDESCHNEIDPLATTEN UND WERKZEUGHALTER ZUM GEWINDEWIRBELN

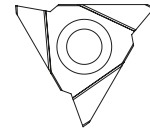

	DREHEN - AUßENDREHHALTER
S29	BEZEICHNUNGSSCHLÜSSEL FÜR DREHALTER AUßENBEARBEITUNG
S30-S39	T-SYSTEM AUSSEN - DREHHALTER
S40-S42	M-SYSTEM AUSSEN - DREHHALTER
S43-S50	P SYSTEM AUSSEN - DREHHALTER
S51-S57	C SYSTEM AUSSEN - DREHHALTER
S58-S71	S SYSTEM AUSSEN - DREHHALTER
S71-S76	S-SYSTEM FÜR LANGDREHAUTOMATEN
S75-S77	SEC TOOLS

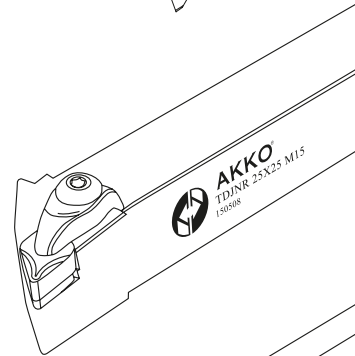

	DREHWERKZEUGE FÜR DIE INNENBEARBEITUNG
S78	BOHRSTANGE BEZEICHNUNGSSYSTEM
S79-S84	T&C SYSTEM BOHRSTANGE
S85-S89	M-SYSTEM BOHRSTANGE
S90-S95	P- SYSTEM BOHRSTANGE
S96-S111	S- SYSTEM BOHRSTANGE

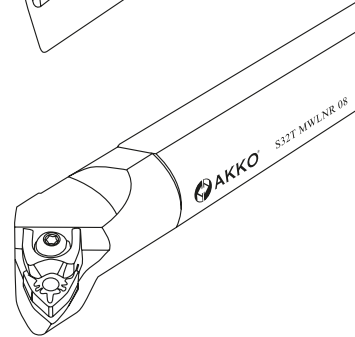

	KURZDREHHALTER
S113	KURZDREHHALTER BEZEICHNUNGSSYSTEM
S114-S115	S-SYSTEM KURZDREHHALTER FÜR DIE MOTORINSTANDHALTUNG
S116-S118	S-SYSTEM KURZDREHHALTER
S119-S121	S-SYSTEM KURZDREHHALTER

	GEWINDE DREHHALTER
S123	GEWINDE DREHHALTER BEZEICHNUNGSSYSTEM
S124-S129	AUSSEN-GEWINDEDREHHALTER

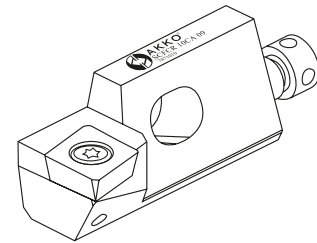

	STECHHALTER
S131	STECHHALTER BEZEICHNUNGSSYSTEM
S132-S144	AUßEN-STECHHALTER
S144-S146	WERKZEUGE ZUR STECHBEARBEITUNG AUF LANGDREHAUTOMATEN
S147-S149	AXIAL-STECHHALTER
S149	AXIAL STECHHALTER L-TYPE
S150-S151	STECHSCHWERT FÜR ABSTECHEN UND TIEFE EINSTICHE
S151	SPANNBLOCK FÜR STECHSCHWERT
S152-S161	INNEN-STECHHALTER

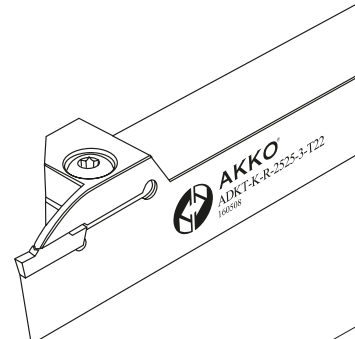

	BOHRWERKZEUGE
S165-S188	VOLLBOHRER / BEZEICHNUNGSSYSTEM FÜR VOLLBOHRER
S189-S190	FASRING FÜR VOLLBOHRER
S191	EXENTRISCHER ADAPTER FÜR WENDEPLATTENBOHRER
S192	BESTELLFORMULAR FÜR SONDERBOHRER
S195-S196	BEZEICHNUNGSSYSTEM FÜR MULTIFUNKTIONALES DREH-UND BOHRWERKZEUG / BOHREN, INNEN-UND AUßENDREHEN
S198-S202	BEZEICHNUNGSSYSTEM FÜR EINSTELLBBARE SPINDELKÖPFE / EINSTELLBARE SPINDELKÖPFE

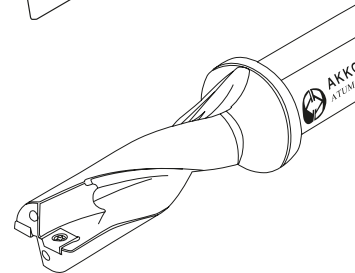

	FRÄSWERKZEUGE
S204	BEZEICHNUNGSSYSTEM FÜR FRÄSER
S205-S206	S-SYSTEM FASFRÄSER
S206	HELIX-FASFRÄSER
S207	SENKWERKZEUG FÜR ZYLINDERKOPFSCHRAUBEN (DIN 974-1)
S208-S231	S-SYSTEM SCHAFTFRÄSER
S232-S234	S-SYSTEM KOPIER- UND SCHAFTFRÄSER
S235-S244	S-SYSTEM HOCHVORSCHUB- SCHAFTFRÄSER
S244-S252	S-SYSTEM EINSCHRAUBFRÄSER
S253-S260	S-SYSTEM HOCHVORSCHUB-EINSCHRAUBFRÄSER
S260-S262	KUGELKOPIERFRÄSER
S262-S263	MODULARE EINSCHRAUB-KUGELFRÄSER
S264	AUFNAHME FÜR EINSCHRAUBFRÄSER
S265-S266	GEWINDEFÄSERWERKZEUGE
S267	S-SYSTEM WENDELSCHAFTFRÄSER
S268-S299	PLAN UND ECKMESSERKÖPFE
S300-S303	MESSERKÖPFE FÜR RUNDE WENDESCHNEIDPLATTEN
S304-S306	PLAN UND ECKMESSERKÖPFE
S307-S313	HOCHVORSCHUBFRASER
S314-S315	T-NUTENFRASER
S316-S317	SCHEIBENFRASER
S318-S323	ABMESSUNGEN DER AUFNAHMEBOHRUNGEN FÜR MESSERKÖPFE

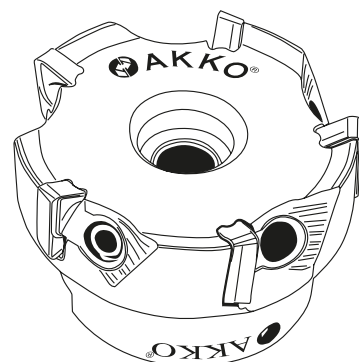

	ERSATZTEILE
S324-S337	ERSATZTEILE
S338-S339	INDEX

konusulan
the spoken kalite...
quality...





KESİCİ UÇLAR ve TAKIMLARI

CUTTING INSERTS and TOOLHOLDERS

WENDESCHNEIDPLATTEN und WERKZEUGE

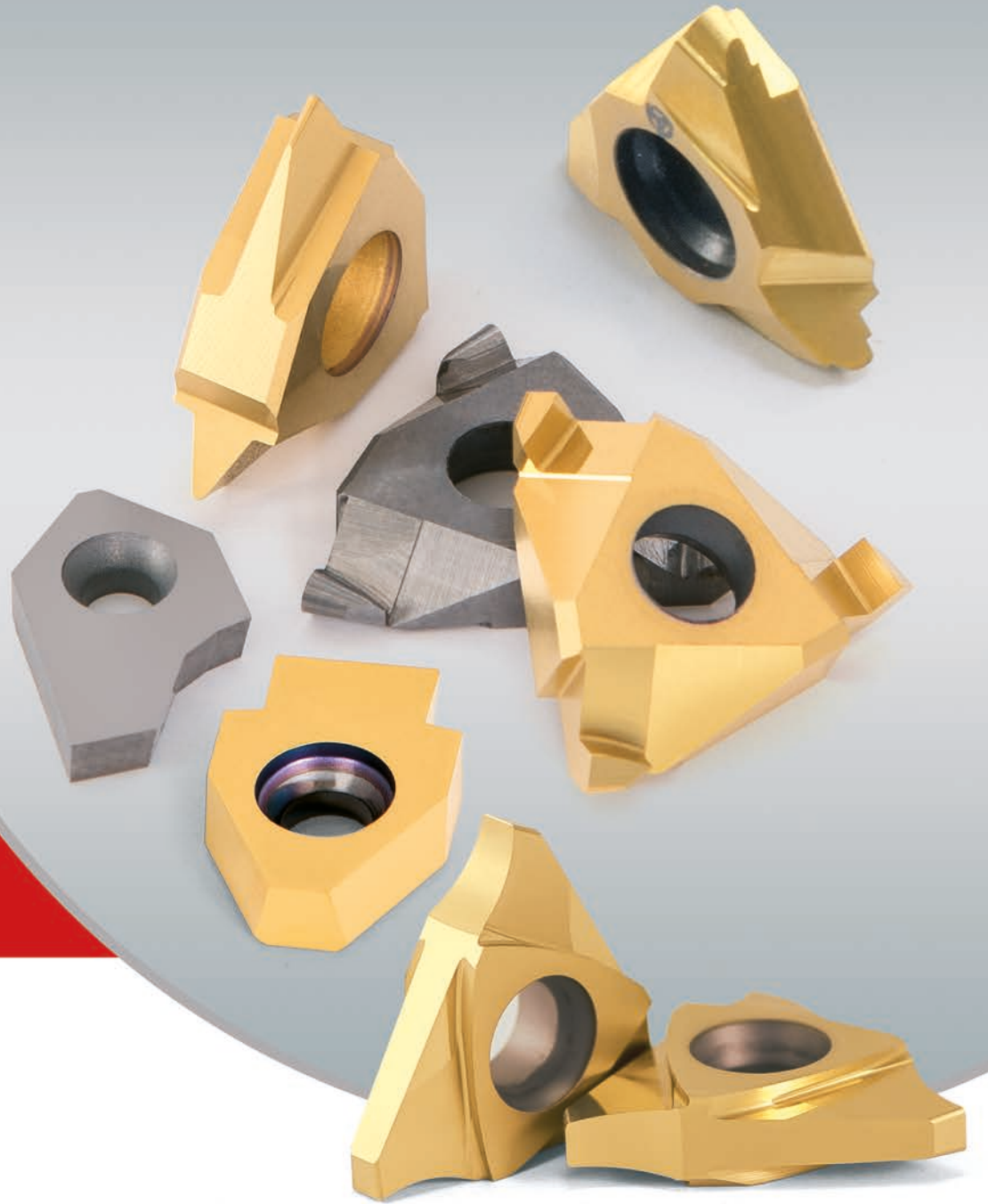

POLY-V

POLY-V KANAL AÇMA UÇLARI ve TAKIMLARI
POLY-V GROOVING INSERTS and TOOLHOLDERS
POLY-V EINSTECHPLATTEN UND WERKZEUGE



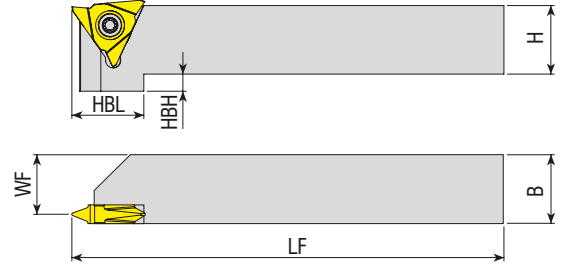

Takım Kodu Ordering Code Bestell-Bezeichnung	Stok Stock Lager		Takım Ölçüleri (mm) Dimension (mm) Abmessung (mm)					Kesici Uç Insert Wendeschneidplatte	Yedek Parçaları / Spare Parts / Ersatzteile		
	R	L	H	B	WF	LF	HBL		HBH	Sıkma Vidası Screw Schraube	Tork Anahtar Torx Key Torx-Schlüssel
ADKT-T12P-R/L-1616-T5	●	●	16	16	13.50	125	21	5			
ADKT-T12P-R/L-2020-T5	●	●	20	20	17.50	125	21	5			
ADKT-T12P-R/L-2525-T5	●	●	25	25	22.50	150	-	-			
ADKT-T12P-R/L-3232-T5	●	●	32	32	29.50	170	-	-			

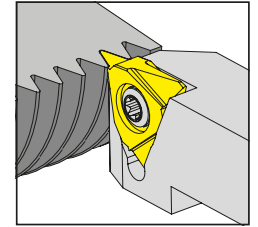
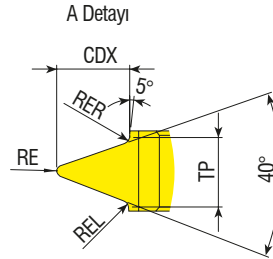
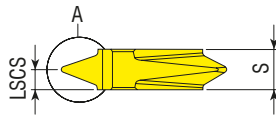
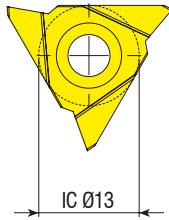
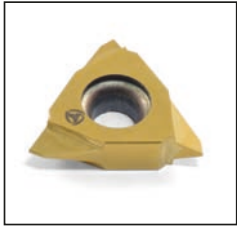

Uç Kodu Insert Code Wendepplatten-Bezeichnung	Stok Stock Lager	Uç Ölçüleri (mm) Insert Dimension (mm) Abmessung (mm)						Kalite Grade Sorte
		TP	S	RE	RER / REL	LSCS	CDX	
T12.10.0234.PJ.R	●	2.34	5.20	0.25	0.20	2.60	2.30	VK20F01
T12.10.0356.PK.R	●	3.56	5.20	0.35	0.25	2.60	3.69	VK20F01
T12.10.0470.PL.R	●	4.70	5.20	0.33	0.40	2.60	5.02	VK20F01

ADKT-T12P..Tipi katerler ile kullanınız. / Use with ADKT-T12P.. Type toolholder. / Einsatz mit ADKT-T12P...-Werkzeughalter
İndekslenişinde boy $\pm 0,02$ mm / Indexability length $\pm 0,02$ mm / Wiederholgenauigkeit Länge $\pm 0,02$ mm

Diğer ölçü talepleriniz için müşteri temsilciniz ile irtibata geçiniz. / For other dimension request, contact with customer representative. / Für weitere Abmessungen kontaktieren Sie bitte den Vertrieb.

R: Sağ / Right / Rechts L: Sol/Left/Links

● Stokta / In Stock / Auf Lager ○ Stokta Yok / Non Stock Item / Kein Lagerartikel, Lieferzeit auf Anfrage

Sipariş Örneği/Ordering Example/Bestellbeispiel

1 ad./pcs./stück ADKT-T12P-R-1616-T5

KANAL AÇMA



KANAL AÇMA, KÖŞE BOŞALTMA UÇLARI ve TAKIMLARI
INSERTS and TOOLHOLDERS FOR GROOVING CORNER RELIEFS
WENDESCHNEIDPLATTEN UND WERKZEUGE FÜR
AXIAL FREISTICHE



AKKO®
AAUT-T20-R-25

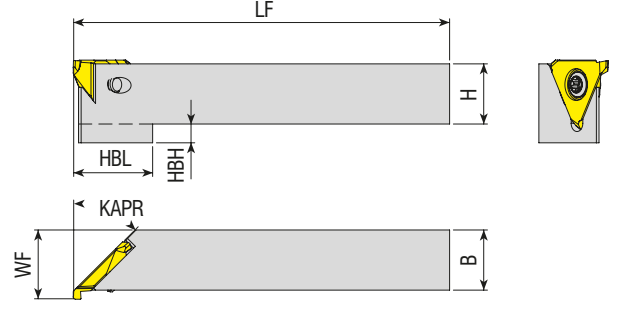



Takım Kodu Ordering Code Bestell-Bezeichnung	Stok Stock Lager		Takım Ölçüleri (mm) Dimension (mm) Abmessung (mm)							Kesici Uç Insert Wendeschneidplatte	Yedek Parçaları / Spare Parts / Ersatzteile			
	R	L	H	B	WF	LF	HBL	HBH	KAPR		Sıkma Vidası Screw Schraube	Tork Anahtar Torx Key Torx-Schlüssel		
AAUT-T20-R/L-1616-45	●	●	16	16	18.3	125	21	5	45°					
AAUT-T20-R/L-2020-45	●	●	20	20	22.3	125	21	5	T20...				1020-M5x7.5	80-T20
AAUT-T20-R/L-2525-45	●	●	25	25	27.3	150	-	-	45°					

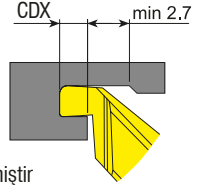
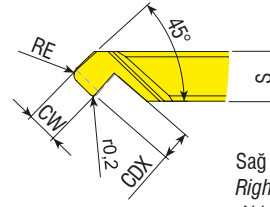
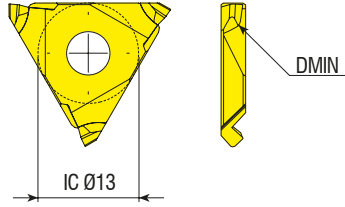

Sağ versiyon gösterilmiştir
 Right hand version shown
 Abbildung zeigt rechte Ausführung

Uç Kodu Insert Code Wendeschneidplatten-Bezeichnung	Stok Stock Lager		Uç Ölçüleri (mm) Insert Dimension (mm) Abmessung (mm)					Kalite Grade Sorte	Minimum Çap Ø Minimum Diameter Ø Kleinster Durchmesser ø	Kanal Derinliği Depth of Groove Up to Stechtiefe bis zu	Kanal Genişliği Width of Groove Stechbreite
	R	L	CW	S	RE	CDX	DMIN				
T20.00.0815.45.04R/L	●	●	1.5	3.25	0.4	1.6	8	VK20F01	8	1.6	1.5
T20.00.1220.45.05R/L	●	○	2.0	3.25	0.5	1.8	12	VK20F01	12	1.8	2.0
T20.00.2024.45.06R/L	●	○	2.4	3.25	0.6	2.0	20	VK20F01	20	2.0	2.4

AAUT.. Tipi katerlerle kullanınız. / Use with AAUT type toolholder. / Einsatz mit AAUT-Werkzeughalter
 Kullanım öncesinde dip boşluk işlenmiş olmalıdır. / The undercut must be placed before axial machining. / Der Freistich muss vor der Axialbearbeitung gefertigt werden
 İndekslediğinde boy ±0.02mm / Indexability length ±0.02mm / Wiederholgenauigkeit Länge ± 0,02 mm

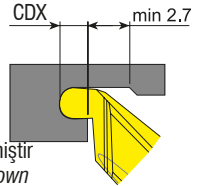
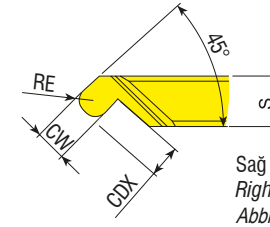
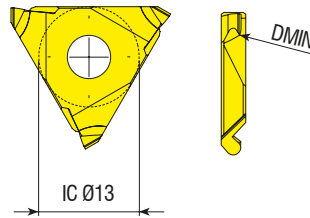

Sağ versiyon gösterilmiştir
 Right hand version shown
 Abbildung zeigt rechte Ausführung

Uç Kodu Insert Code Wendeschneidplatten-Bezeichnung	Stok Stock Lager		Uç Ölçüleri (mm) Insert Dimension (mm) Abmessung (mm)					Kalite Grade Sorte	Minimum Çap Ø Minimum Diameter Ø Kleinster Durchmesser ø	Kanal Derinliği Depth of Groove Up to Stechtiefe bis zu	Kanal Genişliği Width of Groove Stechbreite
	R	L	CW	S	RE	CDX	DMIN				
T20.00.1220.45.10R/L	●	○	2.0	3.25	1.0	1.8	12	VK20F01	12	1.8	2

AAUT.. Tipi katerlerle kullanınız. / Use with AAUT type toolholder. / Einsatz mit AAUT-Werkzeughalter
 Kullanım öncesinde dip boşluk işlenmiş olmalıdır. / The undercut must be placed before axial machining. / Der Freistich muss vor der Axialbearbeitung gefertigt werden
 İndekslediğinde boy ±0.02mm / Indexability length ±0.02mm / Wiederholgenauigkeit Länge ± 0,02 mm

R: Sağ / Right / Rechts L: Sol/Left/Links
 ● Stokta / In Stock / Auf Lager ○ Stokta Yok / Non Stock Item / Kein Lagerartikel, Lieferzeit auf Anfrage

Sipariş Örneği/Ordering Example/Bestellbeispiel
 1 ad./pcs./stück AAUT-T20-R-1616-45

BROŞ

BROŞ ÇEKME UÇLARI ve TAKIMLARI

BROACHING INSERTS and TOOLHOLDERS

*WENDESCHNEIDPLATTEN UND WERKZEUGHALTER FÜR
DIE NUTBEARBEITUNG*

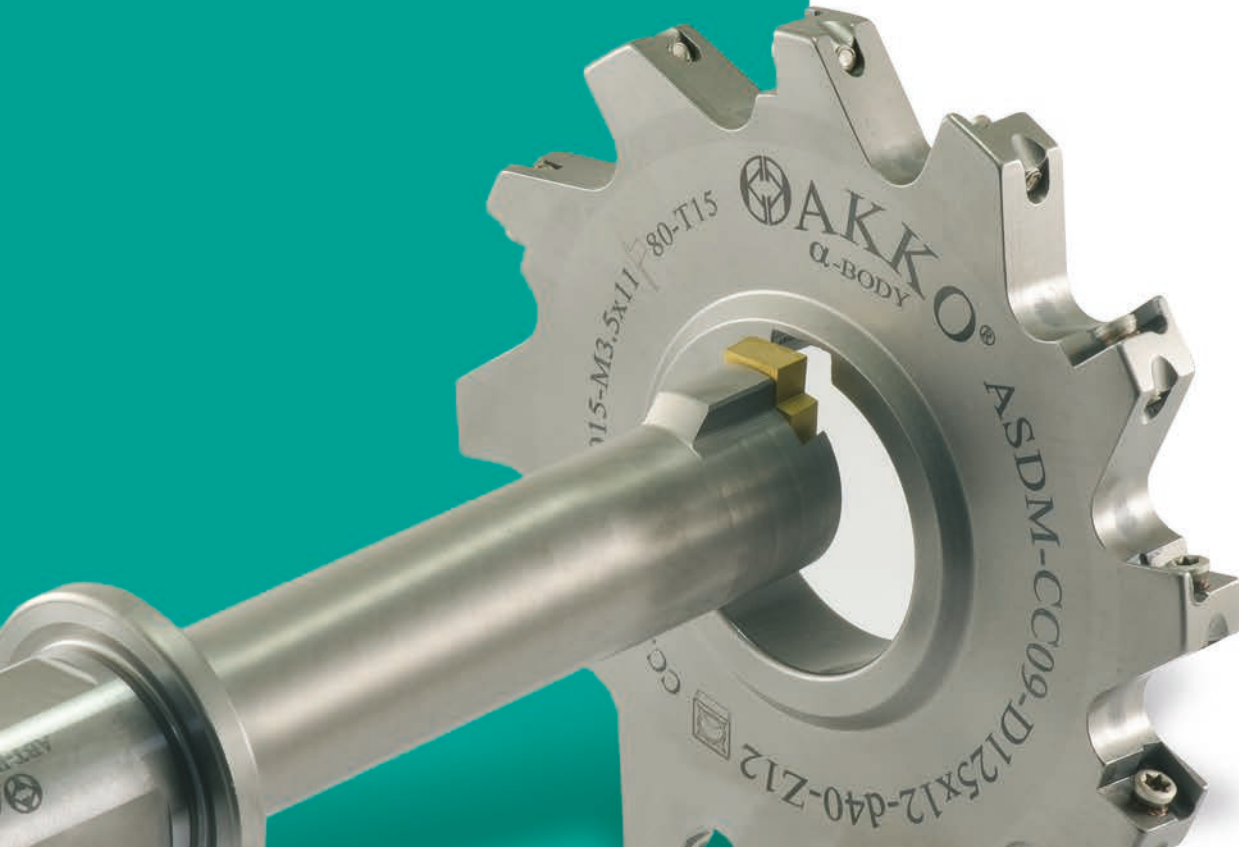

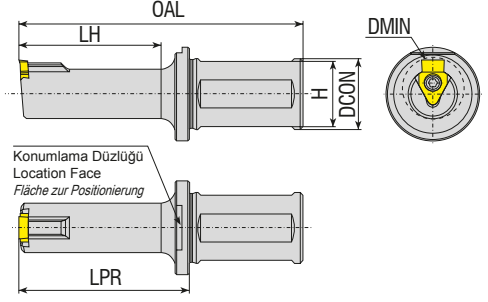

Takım Kodu Ordering Code Bestell-Bezeichnung	Stok Stock Lager	Takım Ölçüleri (mm) Dimension (mm) Abmessung (mm)						Kesici Uç Insert Wendeschneidplatte	Yedek Parçaları / Spare Parts / Ersatzteile	
		DMIN	LH	DCON	OAL	LPR	H		Sıkma Vidası Screw Schraube	Tork Anahtar Torx Key Torx-Schlüssel
ABT-B41-D17-Y25-L90-I040	●	17	40	25	90	50	23	B41...	4015-M4x11	80-T15
ABT-B41-D17-Y25-L105-I065	●	17	65	25	105	75	23			
ABT-B41-D22-Y25-L100-I050	●	22	50	25	100	60	23			
ABT-B41-D22-Y25-L125-I070	●	22	70	25	125	80	23			
ABT-B42-D30-Y32-L100-I050	●	30	50	32	100	60	30	B42...	1020-M5x14	80-T20
ABT-B42-D30-Y32-L125-I075	●	30	75	32	125	85	30			
ABT-B42-D30-Y32-L170-I110	●	30	110	32	170	120	30			
ABT-B42-D38-Y32-L100-I050	●	38	50	32	100	60	30			
ABT-B42-D38-Y32-L125-I075	●	38	75	32	125	85	30			
ABT-B42-D40-Y32-L100-I050	●	40	50	32	100	60	30			
ABT-B42-D40-Y32-L125-I075	●	40	75	32	125	85	30			

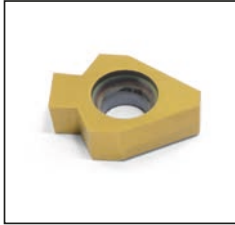

DIN138 (Tolerans C11) torna ve freze tezgahlarında broş çekme uçları.
DIN138 (Tolerance C11) inserts for keyway broaching on lathe and milling machines.
DIN 138 (Toleranz C11) Wendeplatten für Keilnutenfertigung auf Dreh- und Fräsmaschinen

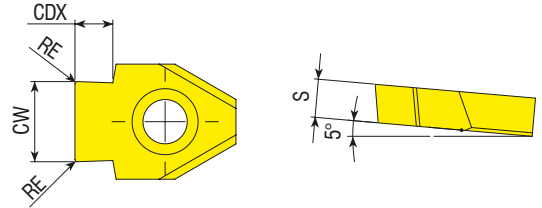

Uç Kodu Insert Code Wendeplatten-Bezeichnung	Stok Stock Lager	Uç Ölçüleri (mm) Insert Dimension (mm) Abmessung (mm)				
		CW	RE	CDX	S	DMIN
B41.00.0612.085.VP3001	●	6.12	0.85	2.6	4.0	22
B41.00.0713.085.VP3001	●	7.13	0.85	3.3	4.0	22
B41.00.0813.105.VP3001	●	8.13	1.05	3.4	4.0	22
B42.00.1013.105.VP3001	●	10.13	1.05	4.2	6.0	30
B42.00.1215.135.VP3001	●	12.15	1.35	5.1	6.0	38
B42.00.1215.175.VP3001	●	12.15	1.75	6.6	6.0	38
B42.00.1215.225.VP3001	●	12.15	2.25	8.5	6.0	38

Tipik kesme şartları / Typical cutting conditions / Standard-Schneidbedingungen: İlerleme (Vf): 3000-8000 mm/dak (min) / Paso (ap): 0.02-0.08 mm / Vorschub (Vf): 3000-8000 mm/min

R: Sağ / Right / Rechts L: Sol/Left/Links

● Stokta / In Stock / Auf Lager ○ Stokta Yok / Non Stock Item / Kein Lagerartikel, Lieferzeit auf Anfrage

Sipariş Örneği/Ordering Example/Bestellbeispiel/

1 ad./pcs./stück ABT-B41-D17-Y25-L90-I040

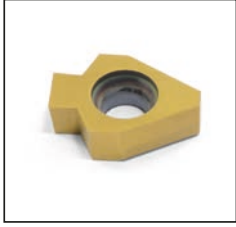

DIN6885 (Tolerans P9) torna ve freze tezgahlarında broş çekme uçları.
DIN6885 (Tolerance P9) inserts for keyway broaching on lathe and milling machines.
DIN6885 (Toleranz P9) Wendeplatten für Keilnutenfertigung auf Dreh- und Fräsmaschinen

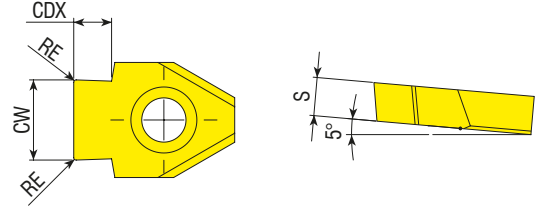

Uç Kodu Insert Code Wendeplatten-Bezeichnung	Stok Stock Lager	Uç Ölçüleri (mm) Insert Dimension (mm) Abmessung (mm)				
		CW	RE	CDX	S	DMIN
B41.00.0498.020.VP3001	●	4.98	0.20	2.7	4.0	17
B41.00.0598.020.VP3001	●	5.98	0.20	3.4	4.0	17
B41.00.0798.020.VP3001	●	7.98	0.20	4.1	4.0	22
B42.00.0998.030.VP3001	●	9.98	0.30	4.2	6.0	30
B42.00.1197.030.VP3001	●	11.97	0.30	5.7	6.0	38
B42.00.1397.030.VP3001	●	13.97	0.30	6.8	6.0	40

Tipik kesme şartları / Typical cutting conditions / Standard-Schneidbedingungen: İlerleme (Vf): 3000-8000 mm/dak (min) / Paso (ap): 0.02-0.08 mm / Vorschub (Vf): 3000-8000 mm/min



DIN6885 (Tolerans JS9) torna ve freze tezgahlarında broş çekme uçları.
DIN6885 (Tolerance JS9) inserts for keyway broaching on lathe and milling machines.
DIN6885 (Toleranz JS9) Wendeplatten für Keilnutenfertigung auf Dreh- und Fräsmaschinen

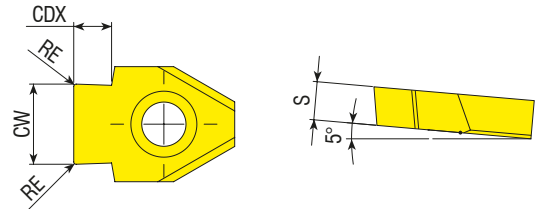

Uç Kodu Insert Code Wendeplatten-Bezeichnung	Stok Stock Lager	Uç Ölçüleri (mm) Insert Dimension (mm) Abmessung (mm)				
		CW	RE	CDX	S	DMIN
B41.00.0501.020.VP3001	●	5.01	0.20	2.7	4.0	17
B41.00.0601.020.VP3001	●	6.01	0.20	3.4	4.0	17
B41.00.0801.020.VP3001	●	8.01	0.20	4.1	4.0	22
B42.00.1001.030.VP3001	●	10.01	0.30	4.2	6.0	30
B42.00.1200.050.VP3001	●	12.00	0.50	8.5	6.0	38
B42.00.1201.030.VP3001	●	12.01	0.30	5.7	6.0	38
B42.00.1401.030.VP3001	●	14.01	0.30	6.8	6.0	40

Tipik kesme şartları / Typical cutting conditions / Standard-Schneidbedingungen: İlerleme (Vf): 3000-8000 mm/dak (min) / Paso (ap): 0.02-0.08 mm / Vorschub (Vf): 3000-8000 mm/min

R: Sağ / Right / Rechts L: Sol/Left/Links

● Stokta / In Stock / Auf Lager ○ Stokta Yok / Non Stock Item / Kein Lagerartikel, Lieferzeit auf Anfrage

Sipariş Örneği/Ordering Example/Bestellbeispiel

1 ad./pcs./stück B41.00.0498.020.VP3001



Torna ve freze tezgahlarında
kama kanalı pah kırma uçları.
*Inserts for keyway chamfering on
lathe and milling machines.*
Wendeschnidplatten zum Anfasen von
Keilnuten auf Dreh- und Fräsmaschinen

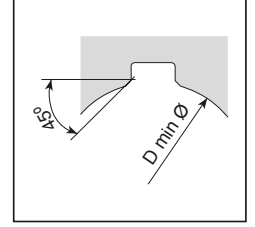
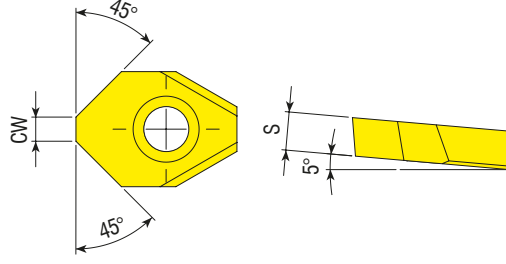

Uç Kodu Insert Code Wendeplatten-Bezeichnung	Stok Stock Lager	Uç Ölçüleri (mm) Insert Dimension (mm) Abmessung (mm)		
		DMIN	CW	S
B41.00.0150.CH.VP3001	●	17	1.5	4.0
B41.00.0300.CH.VP3001	●	22	3.0	4.0
B42.00.0600.CH.VP3001	●	30	6.0	6.0

Tipik kesme şartları / Typical cutting conditions / Standard-Schneidbedingungen: İlerleme (Vf): 3000-8000 mm/dak (min) / Paso (ap): 0.02-0.08 mm / Vorschub (Vf): 3000-8000 mm/min

R: Sağ / Right / Rechts L: Sol/Left/Links

● Stokta / In Stock / Auf Lager ○ Stokta Yok / Non Stock Item / Kein Lagerartikel, Lieferzeit auf Anfrage

Sipariş Örneği/Ordering Example/Bestellbeispiel

1 ad./pcs./stück B41.00.0150.CH.VP3001

PROFİL VERİLMİŞ UÇLAR / PROFILED INSERTS / PROFIL-WENDESCHNEIDPLATTEN
ÖRNEK PROFİLLER / EXAMPLES OF PROFILES / BEISPIELE FÜR PROFILE

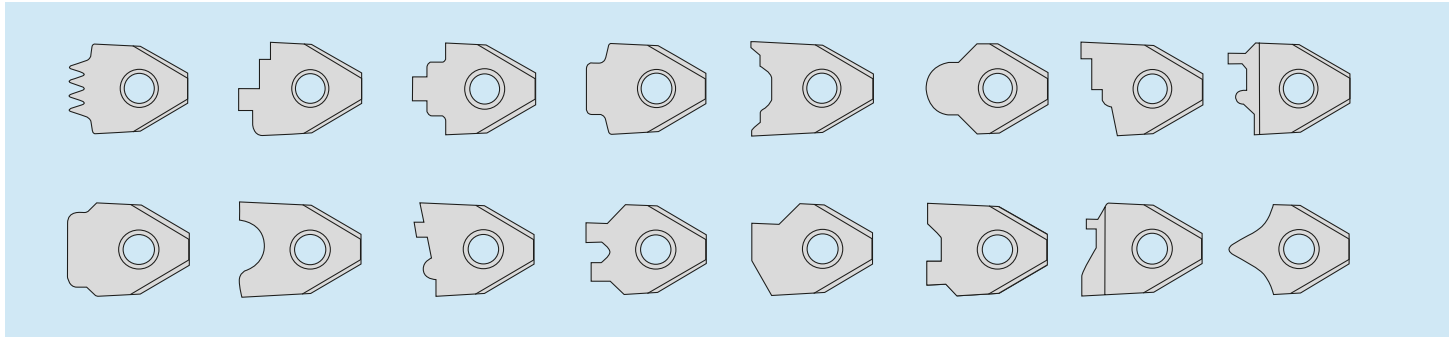

Profil uçlar müşterilerimizin özel taleplerine göre üretilmektedir.
Profiled inserts are manufactured according to customer special requirements.
Die Profil-Wendeschnidplatten werden nach Kundenwunsch gefertigt.

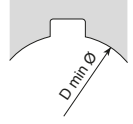
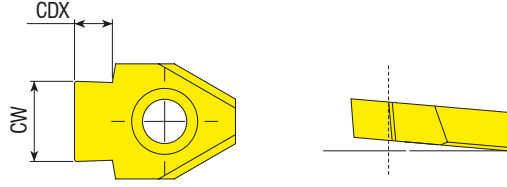

Kanal Geniřliđi Slot Width Stechbreite	Tolerans Tolerance Toleranz	Uç Ölçüsü Insert Size mm Abmessung (mm)	W	t max	Uçlar Inserts Wendeschneidplatten	Uygulanabilir takım ve uç bağlantısı ile Dmin tablosu Applicable Dmin for toolholders and inserts table Entsprechender dmin für Werkzeuge und Wendeschneidplatten				
						ABT-B41-D17...	ABT-B41-D22...	ABT-B42-D30...	ABT-B42-D38...	ABT-B42-D40...
6	C11	6	6.12	2.6	B41.00.0612.085.VP3001		22	X	X	X
7		7	7.13	3.3	B41.00.0713.085.VP3001		27	X	X	X
8		8	8.13	3.4	B41.00.0813.105.VP3001		32	X	X	X
10		10	10.13	4.2	B42.00.1013.105.VP3001	X	X		40	
12		12		5.1	B42.00.1215.135.VP3001	X	X		50	
16		12	12.15	6.6	B42.00.1215.175.VP3001	X	X		70	
24		12		8.5	B42.00.1215.225.VP3001	X	X		100	
5	P9	5	4.98	2.7	B41.00.0498.020.VP3001	17		X	X	X
6		6	5.98	3.4	B41.00.0598.020.VP3001	17		X	X	X
8		8	7.98	4.1	B41.00.0798.020.VP3001		22	X	X	X
10		10	9.98	4.2	B42.00.0998.030.VP3001	X	X	30		
12		12	11.97	5.7	B42.00.1197.030.VP3001	X	X		38	
14		14	13.97	6.8	B42.00.1397.030.VP3001	X	X			40
5	JS9	5	5.01	2.7	B41.00.0501.020.VP3001	17		X	X	X
6		6	6.01	3.4	B41.00.0601.020.VP3001	17		X	X	X
8		8	8.01	4.1	B41.00.0801.020.VP3001		22	X	X	X
10		10	10.01	4.2	B42.00.1001.030.VP3001	X	X	30		
12		12	12.00	8.5	B42.00.1200.050.VP3001	X	X		38	
12		12	12.01	5.7	B42.00.1201.030.VP3001	X	X		38	
14		14	14.01	6.8	B42.00.1401.030.VP3001	X	X			40

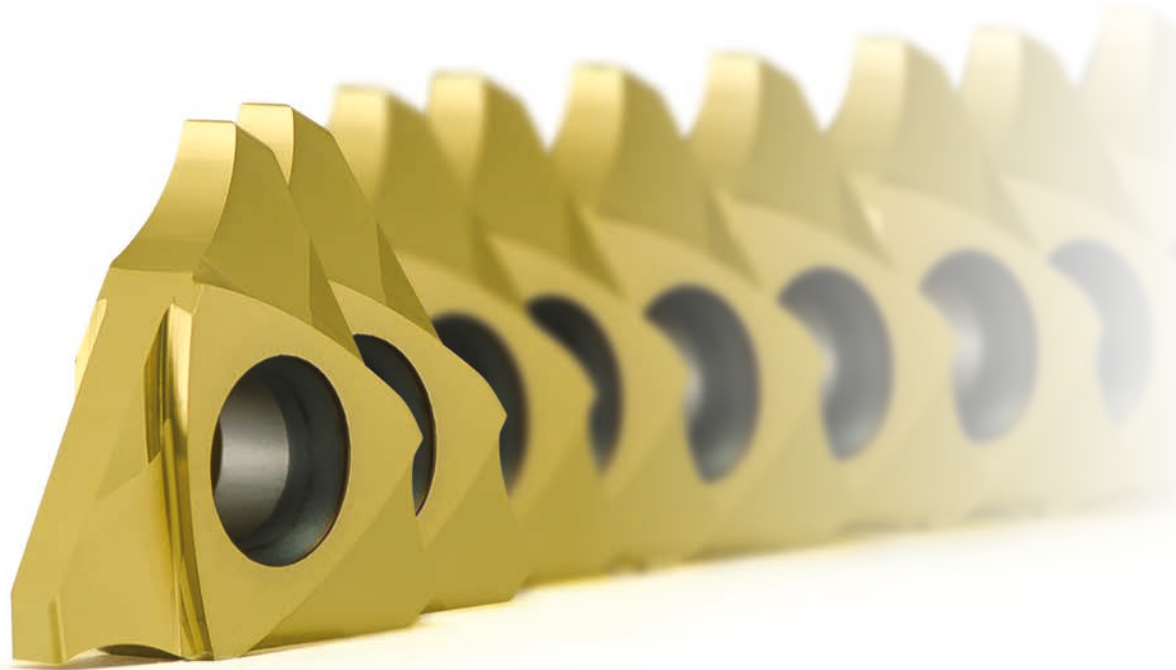

SUPAP

SUPAP YUVASI İŞLEME UÇLARI ve TAKIMLARI
VALVE SEAT INSERTS and TOOLHOLDERS
WENDESCHNEIDPLATTEN UND WERKZEUGE FÜR
VENTILSITZBEARBEITUNG



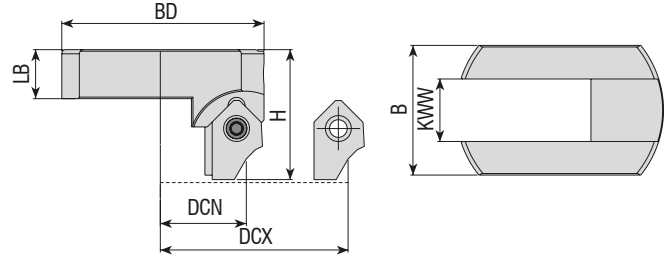

Takım Kodu Ordering Code Bestell-Bezeichnung	Stok Stock Lager	Takım Ölçüleri (mm) Dimension (mm) Abmessung (mm)						Kesici Uç Insert Wendeschneidplatte	Yedek Parçaları / Spare Parts / Ersatzteile				
		DCN DCX	BD	LB	H	KWW	LF		Sıkma Vidası Screw Schraube	Tork Anahtar Torx Key Torx-Schlüssel	Ayar Vidası Adjustable Einstellschraube	Anahtar Allen Key Innensechskantschlüssel	
VST-B11-2842	●	28-42	29	9.5	28.5	12	25.0						
VST-B11-4058	●	40-58	39	9.5	25.0	12	25.0	B11...	3008-M3x8	80-T08	2702-M4x10	AAL-01-02	

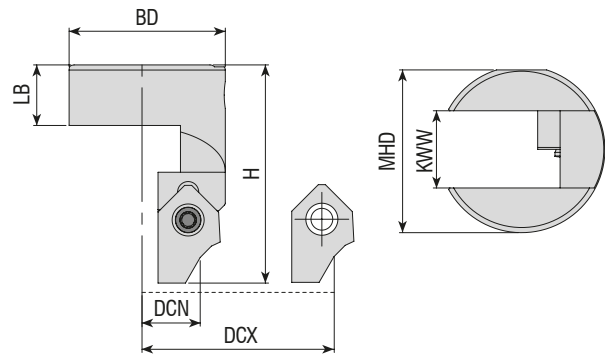

Takım Kodu Ordering Code Bestell-Bezeichnung	Stok Stock Lager	Takım Ölçüleri (mm) Dimension (mm) Abmessung (mm)						Kesici Uç Insert Wendeschneidplatte	Yedek Parçaları / Spare Parts / Ersatzteile				
		DCN DCX	BD	LB	H	KWW	MHD		Sıkma Vidası Screw Schraube	Tork Anahtar Torx Key Torx-Schlüssel	Ayar Vidası Adjustable Einstellschraube	Anahtar Allen Key Innensechskantschlüssel	
VST-B11-1830	●	18-30	24	9.5	34.0	12	25.3						

R: Sağ / Right / Rechts L: Sol/Left/Links

● Stokta / In Stock / Auf Lager ○ Stokta Yok / Non Stock Item / Kein Lagerartikel, Lieferzeit auf Anfrage

Sipariş Örneği/Ordering Example/Bestellbeispiel

1 ad./pcs./stück VST-B11-2842

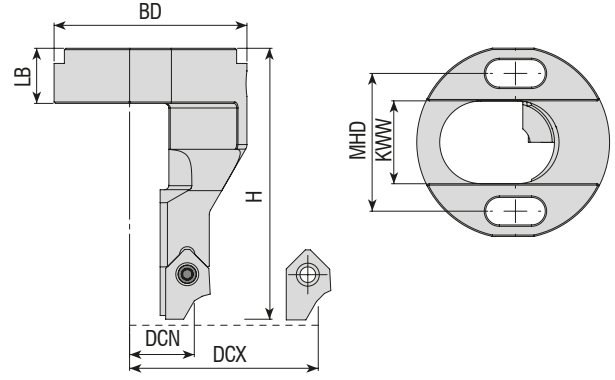

Takım Kodu Ordering Code Bestell-Bezeichnung	Stok Stock Lager	Takım Ölçüleri (mm) Dimension (mm) Abmessung (mm)						Kesici Uç Insert Wendeschneidplatte	Yedek Parçaları / Spare Parts / Ersatzteile				
		DCN DCX	BD	LB	H	KWW	MHD		Sıkma Vidası Screw Schraube	Tork Anahtar Torx Key Torx-Schlüssel	Ayar Vidası Adjustable Einstellschraube	Anahtar Allen Key Innensechskantschlüssel	
VST-B11-2032	●	20-32	42	12	59	18	30	B11...	3008-M3x8	80-T08	2702-M4x10	AAL-01-02	

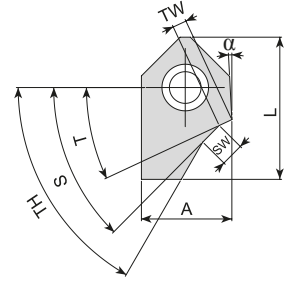
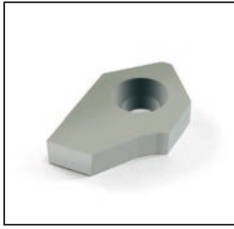

Uç Kodu Insert Code Wendeplatten-Bezeichnung	Stok Stock Lager	Uç Ölçüleri (mm) Insert Dimension (mm) Abmessung (mm)							
		S	SW	T	TW	TH	A	L	α
B11003	●	45	1.3	25	1.1	52	9.7	15.25	3°
B11004	●	45	1.6	25	1.3	52	9.7	15.25	3°
B11005	●	45	2	25	1.3	52	9.7	15.25	3°
B11006	●	45	2.5	25	1.5	52	9.7	15.25	3°
B11007	●	45	1.5	30	1.5	60	9.7	15.25	3°
B11008	●	45	1.3	25	1.1	60	9.7	15.25	3°
B11009	●	45	1.6	25	1.3	60	9.7	15.25	3°
B11010	●	45	2	25	1.3	60	9.7	15.25	3°
B11011	●	30	2	15	1.8	60	9.7	15.25	3°
B11012	●	36	2	15	1.6	60	9.7	15.25	3°
B11014	●	45	2.5	25	1.5	60	9.7	15.25	3°
B11016	●	30	1.5	15	1.3	60	9.7	15.25	3°
B11017	●	30	2.5	15	1.8	60	9.7	15.25	3°
B11018	●	36	2.5	15	1.6	60	9.7	15.25	3°
B11019	●	20	2.5	10	2	75	9.7	15.25	3°
B11020	●	45	1.3	25	1.1	52	7.7	15.25	3°
B11021	●	30	3	15	1.8	60	9.7	15.25	3°
B11022	●	45	3	30	1.8	60	9.7	15.25	3°
B11029	●	40	2.5	25	1.5	60	9.7	15.25	3°
B11030	●	20	2	10	1.3	60	9.7	15.25	3°

R: Sağ / Right / Rechts L: Sol/Left/Links

● Stokta / In Stock / Auf Lager ○ Stokta Yok / Non Stock Item / Kein Lagerartikel, Lieferzeit auf Anfrage

Sipariş Örneği/Ordering Example/Bestellbeispiel

1 ad./pcs./stück VST-B11-2032

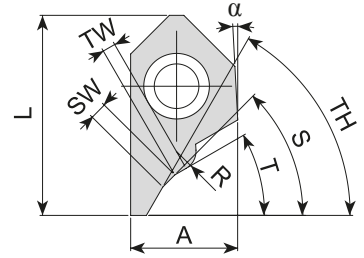
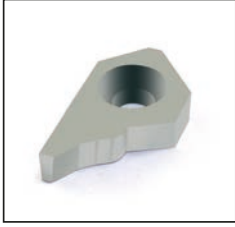

Uç Kodu
Insert Code
Wendeplatten-Bezeichnung

Stok
Stock
Lager

Uç Ölçüleri (mm)
Insert Dimension (mm)
Abmessung (mm)

Uç Kodu Insert Code Wendeplatten-Bezeichnung	Stok Stock Lager	S	SW	T	TW	TH	A	L	α	R
B11013	●	45	1.3	30	1	60	8.15	15.25	3°	1.50

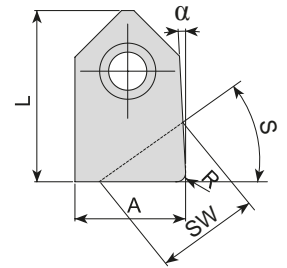

Uç Kodu
Insert Code
Wendeplatten-Bezeichnung

Stok
Stock
Lager

Uç Ölçüleri (mm)
Insert Dimension (mm)
Abmessung (mm)

Uç Kodu Insert Code Wendeplatten-Bezeichnung	Stok Stock Lager	S	SW	A	L	α	R
B11015	●	0°	9.85	9.85	15.25	3°	0.80
B11023	●	0°	7.7	7.7	15.25	3°	0.80
B11024	●	20°	8.2	9.75	15.25	3°	-
B11025	●	25°	10	9.65	15.25	3°	-
B11026	●	30°	9	9.65	15.25	3°	-
B11027	●	35°	10	9.60	15.25	3°	-
B11028	●	45°	8.9	9.55	15.25	3°	-

R: Sağ / Right / Rechts L: Sol/Left/Links

● Stokta / In Stock / Auf Lager ○ Stokta Yok / Non Stock Item / Kein Lagerartikel, Lieferzeit auf Anfrage

Sipariş Örneği/Ordering Example/Bestellbeispiel

1 ad./pcs./stück B11013

WHIRLING

WHIRLING UÇLARI ve TAKIMLARI
WHIRLING INSERTS and TOOLHOLDERS
WENDESCHNEIDPLATTEN UND WERKZEUGHALTER ZUM
GEWINDEWIRBELN



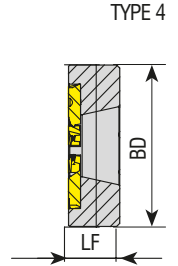
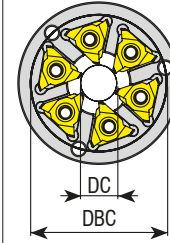
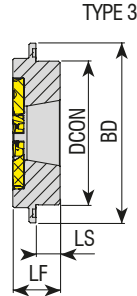
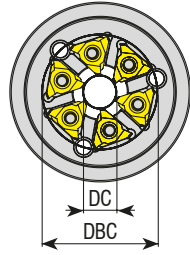
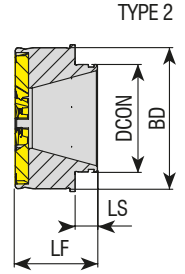
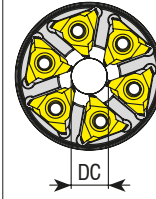
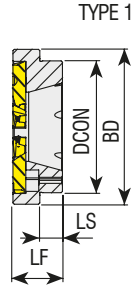
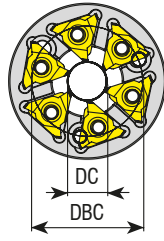

Makine Machine Maschine	Tahrikli Whirling Ünitesi Aggregate Whirling Unit Wirbelspindel	Whirling Ring Kodu Whirling Ring Code Wirbelring	Stok Stock Lager	Takım Ölçüleri (mm) Dimension (mm) Abmessung (mm)								Kesici Uç Insert Wendescheidplatte	Yedek Parçaları / Spare Parts / Ersatzteile	
				ZEPF	DC	DCON	DBC	BD	LS	LF	TYPE		Sıkma Vidası Screw Schraube	Tork Anahtar Torx Key Torx-Schlüssel
STAR	5914 72 00/68172	ATW-301-T09-D1240-Z06	●	6	12	40	33	47	7	15	1			
CITIZEN	BTW1000	ATW-302-T09-D1233-Z06	○	6	12	33	40	47	4	18.5	-			
	GSW101	ATW-303-T09-D0620-Z06	○	6	6	20	26	35	3.2	15	1			
	MWS101/KSW101	ATW-304-T09-D1240-Z06	○	6	12	40	32.5	46	2.5	15.5	1			
	LSW101/BSW215/ LSW215315		○	6	12	40	32.5	46	2.5	15.5	1			
	LSW424		ATW-305-T09-D1245-Z06	○	6	12	45	30	46	9.5	18			
TORNOS	306101/307087	ATW-306-T09-D1240-Z06	●	6	12	40	31	57	3.5	15	-			
	417617	ATW-307-T09-D1250-Z06	○	6	12	50	40	67	3.5	15.4	-			
WTO	TN762004	ATW-308-T09-D1142-Z06	●	6	11	31.97	-	42	6.7	24.7	2			
	TN762006	ATW-309-T09-D2054-Z08	○	8	20	56.5	-	54	1.5	13.8	2			
TSUGAMI	3234 Y342	ATW-310-T09-D1252-Z06	●	6	12	52	42	65	8.7	17	3			
	3268 Y452	ATW-311-T09-D1252-Z06	○	6	12	52	44	52	10	10	3			
	3268 Y271	ATW-312-T09-D1252-Z06	○	6	12	52	38	54	6	19	3			
	3214 Y342	ATW-313-T09-D1650-Z06	○	6	16	50	40	62	8.5	20	3			
	3234 Y342	ATW-314-T09-D2052-Z06	○	6	20	52	42	65	8.7	17	3			
	3281-Y451	ATW-316-T09-D1252-Z06	●	6	12	52	44	52	-	17	4			
HANWHA	MADAULA	ATW-315-T09-D1245-Z06	○	6	12	45	-	56	8.5	15	1			

R: Sağ / Right / Rechts L: Sol/Left/Links

● Stokta / In Stock / Auf Lager ○ Stokta Yok / Non Stock Item / Kein Lagerartikel, Lieferzeit auf Anfrage

Sipariş Örneği/Ordering Example/Bestellbeispiel

1 ad./pcs./stück ATW-301-T09-D1240-Z06

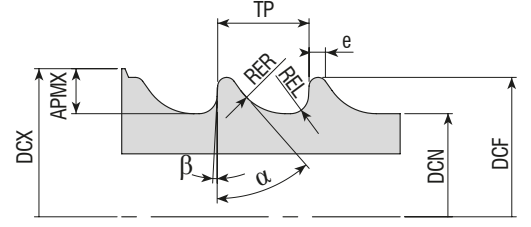
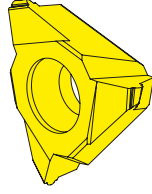

Uç Kodu Insert Code Wendeplatten-Bezeichnung	Kalite Grade Sorte		Standart ISO5835	Uç Ölçüleri (mm) Insert Dimension (mm) Abmessung (mm)									
	VK15U	VK15U01		TP	e	DCF	DCN	RER	REL	α	β	APMX	DCX
T09.HA150.D12	○	○	HA1.5	0.5	0.1	1.35 to 1.5	1.0 to 1.1	0.30	0.1	35°	3°	4	9
T09.HA200.D12	○	○	HA2.0	0.6	0.1	1.85 to 2.0	1.2 to 1.3	0.40	0.1	35°	3°	4	9
T09.HA270.D12	●	●	HA2.7	1	0.1	2.55 to 2.7	1.75 to 1.9	0.60	0.2	35°	3°	4	9.5
T09.HA350.D12	●	●	HA3.5	1.25	0.1	3.35 to 3.5	2.25 to 2.4	0.80	0.2	35°	3°	4	10
T09.HA400.D12	○	○	HA4.0	1.5	0.1	3.85 to 4.0	2.75 to 2.9	0.80	0.2	35°	3°	4	10.5
T09.HA450.D12	●	●	HA4.5	1.75	0.1	4.35 to 4.5	2.85 to 3.0	1.00	0.3	35°	3°	4	11
T09.HA500.D12	○	○	HA5.0	1.75	0.1	4.85 to 5.0	3.35 to 3.5	1.00	0.3	35°	3°	4	11
T09.HB400.D12	○	○	HB4.0	1.75	0.1	3.85 to 4.0	1.75 to 1.9	0.80	0.3	25°	5°	4	9.5
T09.HB650.D12	○	○	HB6.5	2.75	0.2	6.35 to 6.5	2.85 to 3.0	1.20	0.8	25°	5°	4	11

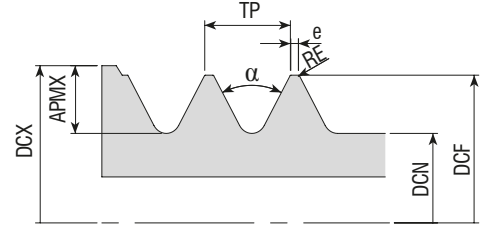
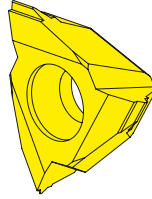
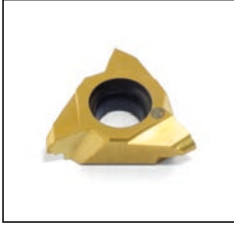

Uç Kodu Insert Code Wendeplatten-Bezeichnung	Kalite Grade Sorte		Standart ISO9268	Uç Ölçüleri (mm) Insert Dimension (mm) Abmessung (mm)							
	VK15U	VK15U01		TP	e	DCF	DCN	α	RE	APMX	DCX
T09.HC290.D12	○	○	HC2.9	1.06	0.1	2.79 to 2.90	2.03 to 2.18	60°	0.01	4	10.5
T09.HC350.D12	○	○	HC3.5	1.27	0.1	3.43 to 3.53	2.51 to 2.64	60°	0.01	4	11
T09.HC390.D12	○	○	HC3.9	1.27	0.1	3.78 to 3.91	2.77 to 2.92	60°	0.01	4	11.5
T09.HC420.D12	○	○	HC4.2	1.27	0.1	4.09 to 4.22	2.95 to 3.25	60°	0.01	4	12

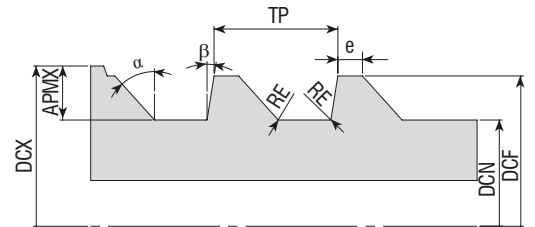
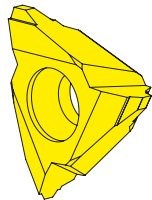
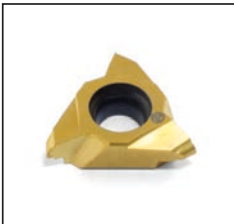

Uç Kodu Insert Code Wendeplatten-Bezeichnung	Kalite Grade Sorte		Standart ISO9268	Uç Ölçüleri (mm) Insert Dimension (mm) Abmessung (mm)								
	VK15U	VK15U01		TP	e	DCF	DCN	RE	α	β	APMX	DCX
T09.HD400.D12	○	○	HD4.0	1.59	0.1	3.97 to 4.03	2.89 to 2.95	0.01	45°	10°	4	11.5
T09.HD450.D12	○	○	HD4.5	2.18	0.1	4.47 to 4.53	2.89 to 2.95	0.01	45°	10°	4	12

R: Sağ / Right / Rechts L: Sol/Left/Links
● Stokta / In Stock / Auf Lager ○ Stokta Yok / Non Stock Item / Kein Lagerartikel, Lieferzeit auf Anfrage

Sipariş Örneği/Ordering Example/Bestellbeispiel
1 ad./pcs./stück T09.HA150.D12

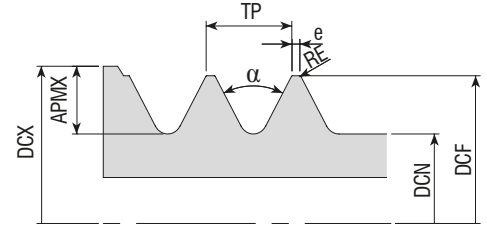
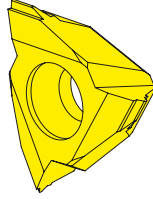
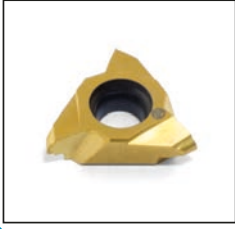

Uç Kodu Insert Code Wendeplatten-Bezeichnung	Kalite Grade Sorte		Standart DIN13	Uç Ölçüleri (mm) Insert Dimension (mm) Abmessung (mm)						
	VK15U	VK15U01		TP	DCF	DCN	a	RE	APMX	DCX
T09.M200.D12			M2	0.4	2	1.509	60	0.048	4	9
T09.M250.D12			M2.5	0.45	2.5	1.928	60	0.055	4	9.5
T09.M300.D12			M3	0.5	3	2.387	60	0.062	4	10
T09.M350.D12			M3.5	0.6	3.5	2.744	60	0.077	4	8.5
T09.M400.D12			M4.0	0.7	4	3.141	60	0.091	4	11
T09.M500.D12			M5.0	0.8	5	4.019	60	0.105	4	11.5
T09.M600.D12			M6.0	1	6	4.773	60	0.134	4	12.5
T09.M700.D12			M7.0	1	7	5.753	60	0.134	4	13.5
T09.M800.D12			M8.0	1.25	8	6.446	60	0.17	4	14

Kesme başlangıç pozisyonu
Cutting Start Position
Startposition Schneidvorgang

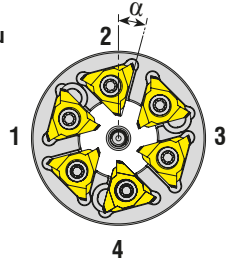

Y Eksen
Y Axis
Y-Achse

İş parçası dönüş yönü
Turning Direction of Workpiece
Drehrichtung Werkstück

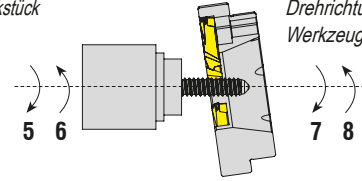

Whirling ünitesi dönüş yönü
Turning Direction of Whirling unit
Drehrichtung Gewindewirbel
Werkzeug

Makine Özellikleri Machine Specifications Angaben zur Maschine		Malzeme Özellikleri Material Specifications Material Besonderheiten	
Makine Üreticisi Machine Manufacturer Maschinenhersteller		Malzeme (DIN, AISI v.b.) Material (DIN, AISI etc.) Material DIN, AISI etc.	
Makine Modeli Machine Model Maschinenbezeichnung		Ham Malzeme Çapı Raw Material Diameter Rohmaterial Durchmesser	
Tahrikli Whirling Ünitesi Üreticisi Live Tool Manufacturer Hersteller angetriebene Werkzeuge		Diş Profili Thread Profile Gewindeprofil	
Tahrikli Whirling Ünitesi Aggregate Whirling Unit Wirbelspindel		Profil Teknik Resmi Profile Technical Drawing Profilzeichnung	
Y - Eksen Y - Axis Y - Achse	Var Exist Ja <input type="checkbox"/>	Yok None Nein <input type="checkbox"/>	Hatve Pitch Steigung
Yüksek Basıncılı Soğutma High Pressure Coolant Hochdruckkühlung	Var Exist Ja <input type="checkbox"/>	Yok None Nein <input type="checkbox"/>	Tek Ağız One Start Eingängig
Kesme Başlangıç Pozisyonu Cutting Start Position Startposition Schneidvorgang	1 <input type="checkbox"/> 2 <input type="checkbox"/> 3 <input type="checkbox"/> 4 <input type="checkbox"/>		İki Ağız Two Starts Zweigängig
Whirling Ünitesi Dönüş Yönü Turning Direction of Whirling Unit Drehrichtung Gewindewirbel-Werkzeug	5 <input type="checkbox"/> 6 <input type="checkbox"/>		Müşteri Adı / Customer Name / Kundennamen:
İş Parçası Dönüş Yönü Turning Direction of Workpiece Drehrichtung Werkstück	7 <input type="checkbox"/> 8 <input type="checkbox"/>		Yetkili / Responsible Person / Ansprechpartner :
α Açısı α Angle α Winkel	Not: Bu açı ürün performansına etki ettiğinden bildirilmesi gerekmektedir. Aksi halinde ring tarafımıza gönderilmelidir. Note: This angle effects the performance of inserts. If doesn't known, tool body should be send to AKKO. Hinweis: Dieser Winkel beeinflusst die Leistung der Wendschneidplatte. Sollte dieser Winkel unbekannt sein, können Sie das Werkzeug zur Fa. AKKO schicken.		
Not / Note / Notizen :			



DIŞ TORNA TAKIMLARI
EXTERNAL TURNING TOOLHOLDERS
DREHEN - AUßENDREHHALTER



P **S** **K** **N** **R**

1 2 3 4 5

1 Sıkma Tipi / Method of Mounting of Insert / Klemmsystem

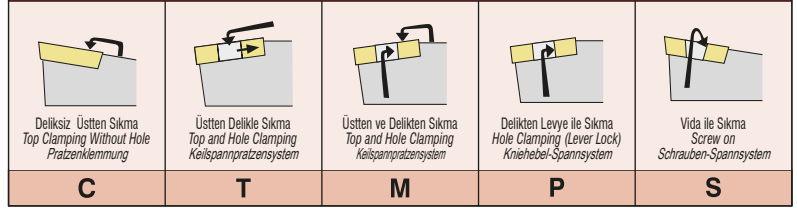

2 Uç Tipi / Type of Insert / Plattenform

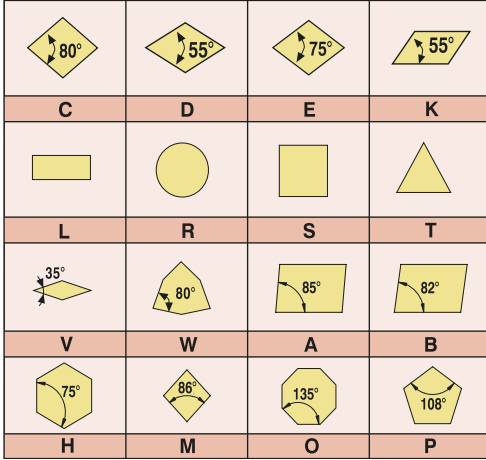

3 Yanaşma Açısı / Tool Holder Shape Bar Geometry / Anstellwinkel

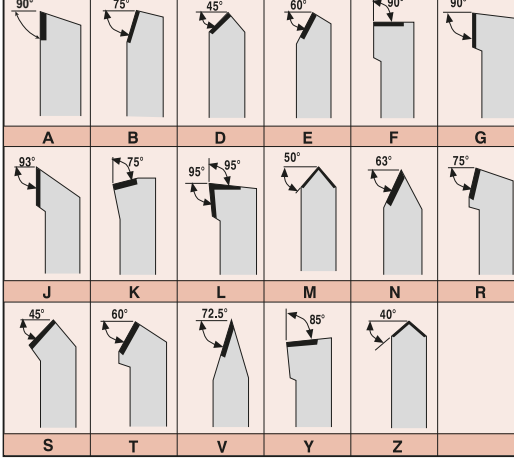

4 Serbest Uç Açısı / Insert Clearance Angle / Freiwinkel / Freiwinkel

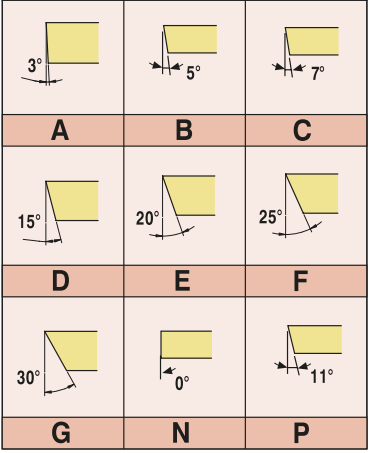

25 **25** - **M** **12** **C**

6 7 8 9 10

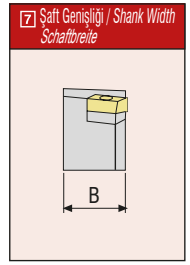
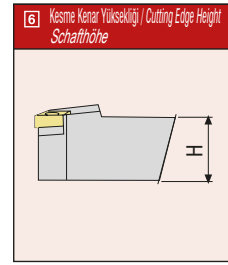
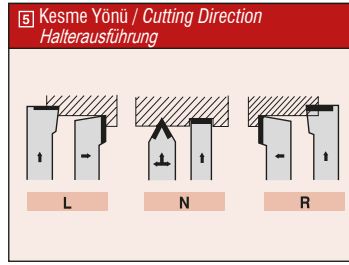

8 Şaft Boyu / Shank Length / Schafflänge

LF

A - 32	H - 100	Q - 180	x-special
B - 40	J - 110	R - 200	
C - 50	K - 125	S - 250	
D - 60	L - 140	T - 300	
E - 70	M - 150	U - 350	
F - 80	N - 160	V - 400	
G - 90	P - 170	W - 450	

(mm)

9 Kesme Kenar Uzunluğu / Cutting Edge Length / Schneidkantenlänge

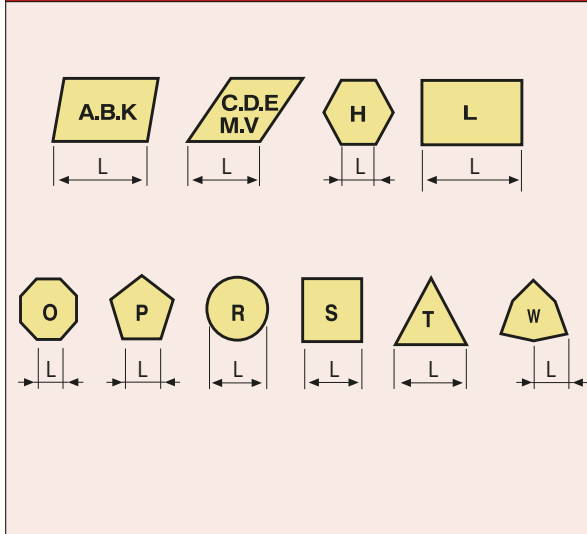

10 Baskı Pabucu
Wedge Clamp
Spannpratze

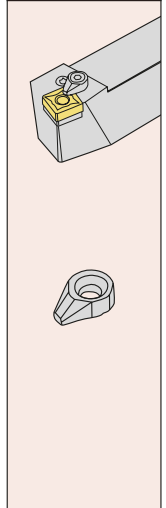



*konusulan
the spoken kalite...
quality...*

T-SİSTEM

T-SİSTEM DIŞ TORNA KATERLERİ
T-SYSTEM EXTERNAL TURNING TOOLHOLDERS
T-SYSTEM AUSSEN - DREHHALTER



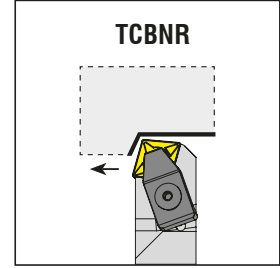
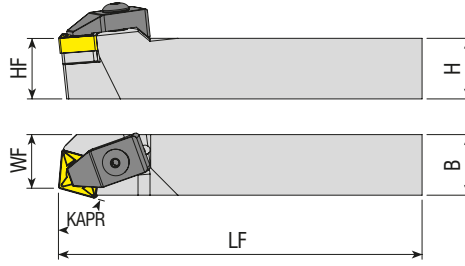

Takım Kodu Ordering Code Bestell-Bezeichnung	Stok Stock Lager		Takım Ölçüleri (mm) Dimension (mm) Abmessung (mm)				Kesici Uç Insert Wendeschneidplatte	Baskı Pabucu Wedge Clamp Spannpratze	Pabuç Vidası Clamp Screw Klemmschraube	Altlık Shim Unterlage	Altlık Vidası Shim Screw Schraube für Unterlage	Sekman Ring Feder	Pul Stamp Ring	Anahtar Allen Key Innensechskantschlüssel
	R	L	HF=H	B	LF	WF								
TCBNR/L 2525 M16	●	●	25	25	150	22						-		
							CNM. 1606..	ATK-04	AKV-19-M7x25	AACN-3-0002	AAV-05-M6x15		ABPL-02	AAL-05-4

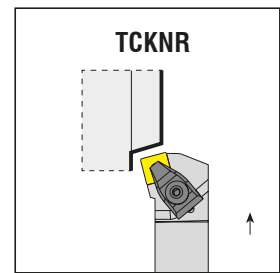
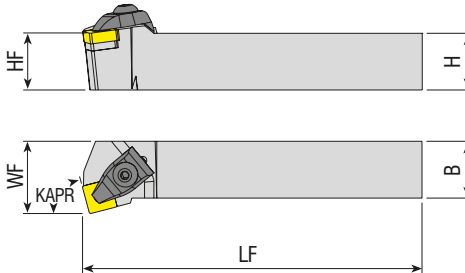

Takım Kodu Ordering Code Bestell-Bezeichnung	Stok Stock Lager		Takım Ölçüleri (mm) Dimension (mm) Abmessung (mm)				Kesici Uç Insert Wendeschneidplatte	Baskı Pabucu Wedge Clamp Spannpratze	Pabuç Vidası Clamp Screw Klemmschraube	Altlık Shim Unterlage	Altlık Vidası Shim Screw Schraube für Unterlage	Sekman Ring Feder	Pul Stamp Ring	Anahtar Allen Key Innensechskantschlüssel
	R	L	HF=H	B	LF	WF								
TCKNR/L 2020 K12	●	●	20	20	125	25								
2525 M12	●	●	25	25	150	32	CNM. 1204..	ATK-02	AKV-30-M6x22	AACN-3-0001	AAV-02-M5x12	AS-01	ABPL-01	AAL-03-3
3232 P12	●	●	32	32	170	40								
2525 M16	●	●	25	25	150	32	CNM. 1606..	ATK-04	AKV-19-M7x25	AACN-3-0002	AAV-05-M6x15	-	ABPL-02	AAL-05-4
3232 P16	●	●	32	32	170	40								

R: Sağ / Right / Rechts L: Sol/Left/Links

● Stokta / In Stock / Auf Lager ○ Stokta Yok / Non Stock Item / Kein Lagerartikel, Lieferzeit auf Anfrage

Sipariş Örneği/Ordering Example/Bestellbeispiel

1 ad./pcs./stück TCBNR 2525 M16

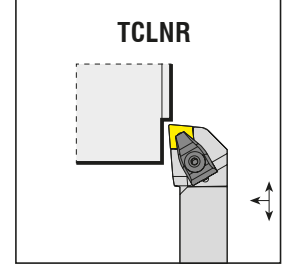
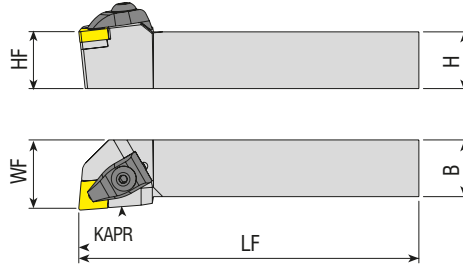

Takım Kodu Ordering Code Bestell-Bezeichnung	Stok Stock Lager		Takım Ölçüleri (mm) Dimension (mm) Abmessung (mm)				Kesici Uç Insert Wendeschneidplatte	Baskı Pabucu Wedge Clamp Spannpratze	Pabuç Vidası Clamp Screw Klemmschraube	Altlık Shim Unterlage	Altlık Vidası Shim Screw Schraube für Unterlage	Sekman Ring Feder	Pul Stamp Ring	Anahtar Allen Key Immerschlüsselschlüssel
	R	L	HF=H	B	LF	WF								
TCLNR/L 2020 K12	●	●	20	20	125	25	CNM. 1204..	ATK-02	AKV-30-M6x22	AACN-3-0001	AAV-02-M5x12	AS-01	ABPL-01	AAL-03-3
2525 M12	●	●	25	25	150	32								
3232 P12	●	●	32	32	170	40								
4040 S12	●	●	40	40	250	50								
5050 S12	●	●	50	50	250	63	CNM. 1606..	ATK-04	AKV-19-M7x25	AACN-3-0002	AAV-05-M6x15	-	ABPL-02	AAL-05-4
2525 M16	●	●	25	25	150	32								
3232 P16	●	●	32	32	170	40								

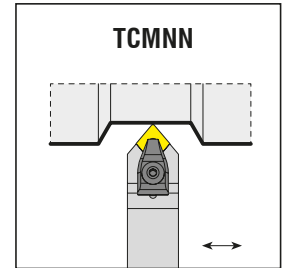
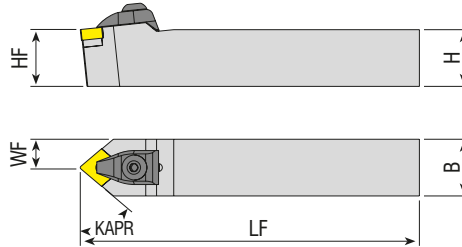

Takım Kodu Ordering Code Bestell-Bezeichnung	Stok Stock Lager		Takım Ölçüleri (mm) Dimension (mm) Abmessung (mm)				Kesici Uç Insert Wendeschneidplatte	Baskı Pabucu Wedge Clamp Spannpratze	Pabuç Vidası Clamp Screw Klemmschraube	Altlık Shim Unterlage	Altlık Vidası Shim Screw Schraube für Unterlage	Sekman Ring Feder	Pul Stamp Ring	Anahtar Allen Key Immerschlüsselschlüssel
	R	L	HF=H	B	LF	WF								
TCMNN 1616 H12	●	○	16	16	100	8	CNM. 1204..	ATK-02	AKV-30-M6x22	AACN-3-0001	AAV-02-M5x12	AS-01	ABPL-01	AAL-03-3
2020 K12	●	○	20	20	125	10								
2525 M12	●	○	25	25	150	12.5								
3232 P12	●	○	32	32	170	16								
2525 M16	●	○	25	25	150	12.5	CNM. 1606..	ATK-04	AKV-19-M7x25	AACN-3-0002	AAV-05-M6x15	-	ABPL-02	AAL-05-4
3232 P16	●	○	32	32	170	16								
4040 S16	○	○	40	40	250	20								

R: Sağ / Right / Rechts L: Sol/Left/Links

● Stokta / In Stock / Auf Lager ○ Stokta Yok / Non Stock Item / Kein Lagerartikel, Lieferzeit auf Anfrage

Sipariş Örneği/Ordering Example/Bestellbeispiel

1 ad./pcs./stück TCLNR 2020 K12

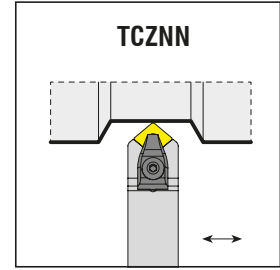
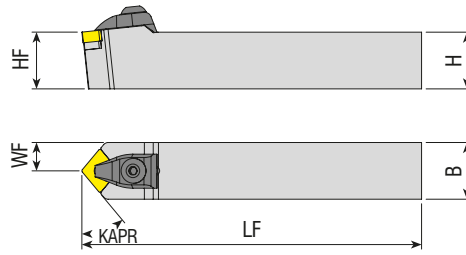
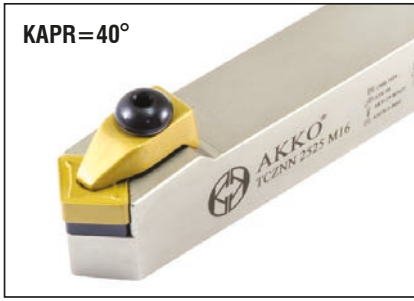

Takım Kodu Ordering Code Bestell-Bezeichnung	Stok Stock Lager		Takım Ölçüleri (mm) Dimension (mm) Abmessung (mm)				Kesici Uç Insert Wendescheidplatte	Baskı Pabucu Wedge Clamp Spannpratze	Pabuç Vidası Clamp Screw Klemmschraube	Altlık Shim Unterlage	Altlık Vidası Shim Screw Schraube für Unterlage	Sekman Ring Feder	Pul Stamp Ring	Anahtar Allen Key Innensechskantschlüssel
	R	L	HF=H	B	LF	WF								
TCZNN 2020 K12	●		20	20	125	10	CNM. 1204..	ATK-02	AKV-30-M6x22	AACN-3-0001	AAV-02-M5x12	AS-01	ABPL-01	AAL-03-3
2525 M12	●		25	25	150	12.5								
3232 P12	●		32	32	170	16								
2525 M16	●		25	25	150	12.5	CNM. 1606..	ATK-04	AKV-19-M7x25	AACN-3-0002	AAV-05-M6x15	-	ABPL-02	AAL-05-4
3232 P16	●		32	32	170	16								

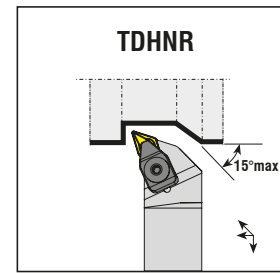
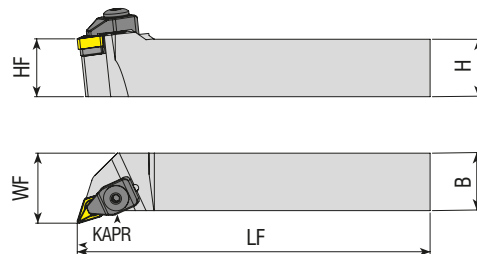

Takım Kodu Ordering Code Bestell-Bezeichnung	Stok Stock Lager		Takım Ölçüleri (mm) Dimension (mm) Abmessung (mm)				Kesici Uç Insert Wendescheidplatte	Baskı Pabucu Wedge Clamp Spannpratze	Pabuç Vidası Clamp Screw Klemmschraube	Altlık Shim Unterlage	Altlık Vidası Shim Screw Schraube für Unterlage	Sekman Ring Feder	Pul Stamp Ring	Anahtar Allen Key Innensechskantschlüssel
	R	L	HF=H	B	LF	WF								
TDHNR/L 2525 M11	○	●	25	25	150	31	DNM. 1104..	ATK-01	AKV-01-M5x22	AADN-2-001	AAV-04-M5x12	-		
2020 K15	●	●	20	20	125	25								
2525 M15	●	●	25	25	150	32	DNM. 1506..	ATK-02	AKV-30-M6x22	AADN-3-0001	AAV-02-M5x12	AS-01	ABPL-01	AAL-03-3
3232 P15	●	●	32	32	170	40								

R: Sağ / Right / Rechts L: Sol/Left/Links
● Stokta / In Stock / Auf Lager ○ Stokta Yok / Non Stock Item / Kein Lagerartikel, Lieferzeit auf Anfrage

Sipariş Örneği/Ordering Example/Bestellbeispiel
1 ad./pcs./stück TCZNN 2020 K12

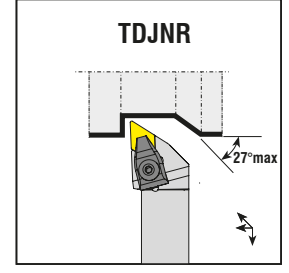
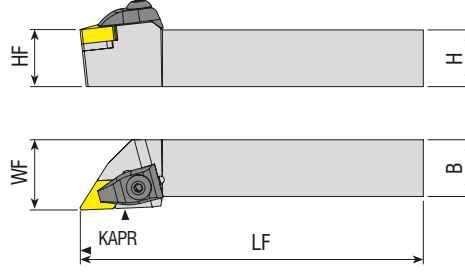

Takım Kodu Ordering Code Bestell-Bezeichnung	Stok Stock Lager		Takım Ölçüleri (mm) Dimension (mm) Abmessung (mm)				Kesici Uç Insert Wendeschneidplatte	Yedek Parçaları / Spare Parts / Ersatzteile						
	R	L	HF=H	B	LF	WF		Baskı Pabucu Wedge Clamp Spannpratze	Pabuç Vidası Clamp Screw Klemmschraube	Altlık Shim Unterlage	Altlık Vidası Shim Screw Schraube für Unterlage	Sekman Ring Feder	Pul Stamp Ring	Anahtar Allen Key Innerschlüssel
TDJNR/L 1616 H11	●	●	16	16	100	20	DNM. 1104..	ATK-01	AKV-01-M5x22	AADN-2-0001	AAV-04-M5x12	-		
2020 K11	●	●	20	20	125	25								
2525 M11	●	●	25	25	150	32								
2020 K15	●	●	20	20	125	25	DNM. 1506..	ATK-02	AKV-30-M6x22	AADN-3-0001	AAV-02-M5x12	AS-01	ABPL-01	AAL-03-3
2525 M15	●	●	25	25	150	32								
3232 P15	●	●	32	32	170	40								
4040 S15	●	●	40	40	250	50								
5050 S15	○	○	50	50	250	63								
2020 K1504	●	●	20	20	125	25	DNM. 1504..	ATK-02	AKV-30-M6x22	AADN-2-0003	AAV-02-M5x12	AS-01		
2525 M1504	●	●	25	25	150	32								
3232 P1504	●	●	32	32	170	40								
4040 S1504	●	●	40	40	250	50								

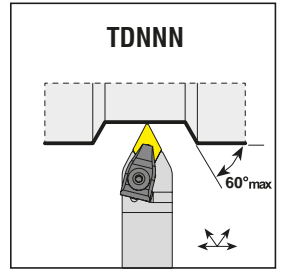
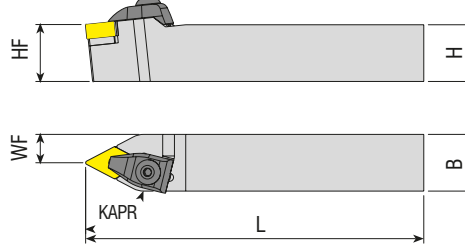

Takım Kodu Ordering Code Bestell-Bezeichnung	Stok Stock Lager		Takım Ölçüleri (mm) Dimension (mm) Abmessung (mm)				Kesici Uç Insert Wendeschneidplatte	Yedek Parçaları / Spare Parts / Ersatzteile						
	R	L	HF=H	B	LF	WF		Baskı Pabucu Wedge Clamp Spannpratze	Pabuç Vidası Clamp Screw Klemmschraube	Altlık Shim Unterlage	Altlık Vidası Shim Screw Schraube für Unterlage	Sekman Ring Feder	Pul Stamp Ring	Anahtar Allen Key Innerschlüssel
TDNNN 1616 H11	●	●	16	16	100	8	DNM. 1104..	ATK-01	AKV-01-M5x22	AADN-2-0001	AAV-04-M5x12	-		
2020 K11	●	●	20	20	125	10								
2525 M11	●	●	25	25	150	12.5								
2020 K15	●	●	20	20	125	10	DNM. 1506..	ATK-02	AKV-30-M6x22	AADN-3-0001	AAV-02-M5x12	AS-01	ABPL-01	AAL-03-3
2525 M15	●	●	25	25	150	12.5								
3232 P15	●	●	32	32	170	16								
4040 S15	○	○	40	40	250	20								
5050 S15	○	○	50	50	250	25								

R: Sağ / Right / Rechts L: Sol/Left/Links

● Stokta / In Stock / Auf Lager ○ Stokta Yok / Non Stock Item / Kein Lagerartikel, Lieferzeit auf Anfrage

Sipariş Örneği/Ordering Example/Bestellbeispiel

1 ad./pcs./stück TDJNR 1616 H11

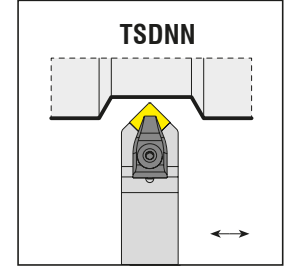
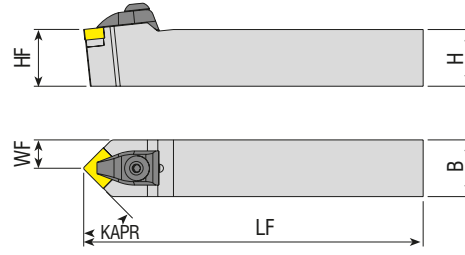

Takım Kodu Ordering Code Bestell-Bezeichnung	Stok Stock Lager	Takım Ölçüleri (mm) Dimension (mm) Abmessung (mm)				Kesici Uç Insert Wendeschneidplatte	Yedek Parçaları / Spare Parts / Ersatzteile						
		HF=H	B	LF	WF		Baskı Pabuçu Wedge Clamp Spannpratze	Pabuç Vidası Clamp Screw Klemmschraube	Altlık Shim Unterlage	Altlık Vidası Shim Screw Schraube für Unterlage	Sekman Ring Feder	Pul Stamp Ring	Anahtar Allen Key Innensechskantschlüssel
TSDNN 1616 H12	●	16	16	100	8	SNM. 1204..	ATK-02	AKV-30-M6x22	AASN-3-0004	AAV-02-M5x12	AS-01	ABPL-01	AAL-03-3
2020 K12	●	20	20	125	10								
2525 M12	●	25	25	150	12.5								
3232 P12	●	32	32	170	16								
2525 M15	○	25	25	150	12.5	SNM. 1506..	ATK-04	AKV-19-M7x25	AASN-3-0023	AAV-05-M6x15	-	ABPL-02	AAL-05-4
3232 P15	●	32	32	170	16								
4040 S15	○	40	40	250	20								

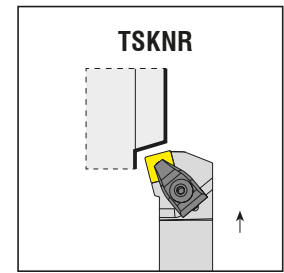
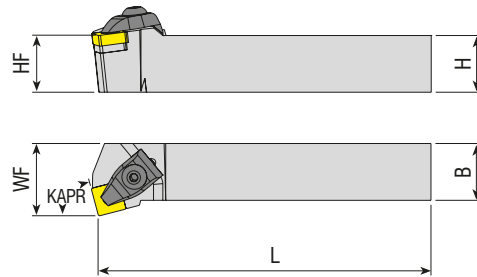

Takım Kodu Ordering Code Bestell-Bezeichnung	Stok Stock Lager		Takım Ölçüleri (mm) Dimension (mm) Abmessung (mm)				Kesici Uç Insert Wendeschneidplatte	Yedek Parçaları / Spare Parts / Ersatzteile						
	R	L	HF=H	B	LF	WF		Baskı Pabuçu Wedge Clamp Spannpratze	Pabuç Vidası Clamp Screw Klemmschraube	Altlık Shim Unterlage	Altlık Vidası Shim Screw Schraube für Unterlage	Sekman Ring Feder	Pul Stamp Ring	Anahtar Allen Key Innensechskantschlüssel
TSKNR/L 2020 K12	●	●	20	20	125	25	SNM. 1204..	ATK-02	AKV-30-M6x22	AASN-3-0004	AAV-02-M5x12	AS-01	ABPL-01	AAL-03-3
2525 M12	●	●	25	25	150	32								
3232 P12	●	●	32	32	170	40								
3232 P15	●	●	32	32	170	40	SNM. 1506..	ATK-04	AKV-19-M7x25	AASN-3-0023	AAV-05-M6x15	-	ABPL-02	AAL-05-4

R: Sağ / Right / Rechts L: Sol/Left/Links

● Stokta / In Stock / Auf Lager ○ Stokta Yok / Non Stock Item / Kein Lagerartikel, Lieferzeit auf Anfrage

Sipariş Örneği/Ordering Example/Bestellbeispiel

1 ad./pcs./stück TSDNN 1616 H12

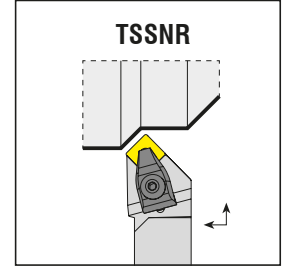
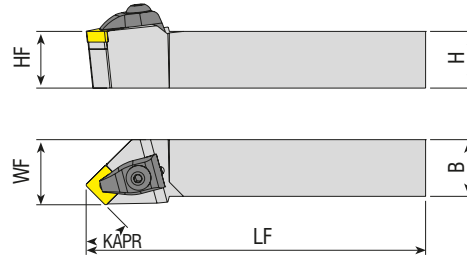

Takım Kodu Ordering Code Bestell-Bezeichnung	Stok Stock Lager		Takım Ölçüleri (mm) Dimension (mm) Abmessung (mm)				Kesici Uç Insert Wendeschneidplatte	Baskı Pabucu Wedge Clamp Spannpratze	Pabuç Vidası Clamp Screw Klemmschraube	Altlık Shim Unterlage	Altlık Vidası Shim Screw Schraube für Unterlage	Sekman Ring Feder	Pul Stamp Ring	Anahtar Allen Key Inmenschenschlüssel							
	R	L	HF=H	B	LF	WF															
TSSNR/L 2020 K12	●	●	20	20	125	25															
2525 M12	●	●	25	25	150	SNM. 1204..									ATK-02	AKV-30-M6x22	AASN-3-0004	AAV-02-M5x12	AS-01	ABPL-01	AAL-03-3
3232 P12	●	●	32	32	170	40															
2525 M15	●	●	25	25	150	32	SNM. 1506..	ATK-04	AKV-19-M7x25	AASN-3-0023	AAV-05-M6x15	-	ABPL-02	AAL-05-4							
3232 P15	●	●	32	32	170	40															

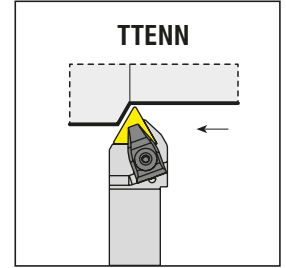
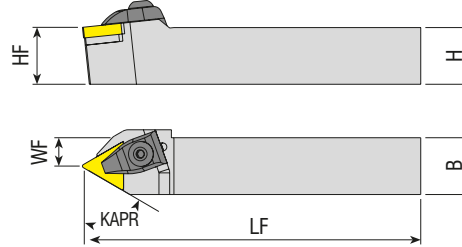

Takım Kodu Ordering Code Bestell-Bezeichnung	Stok Stock Lager		Takım Ölçüleri (mm) Dimension (mm) Abmessung (mm)				Kesici Uç Insert Wendeschneidplatte	Baskı Pabucu Wedge Clamp Spannpratze	Pabuç Vidası Clamp Screw Klemmschraube	Altlık Shim Unterlage	Altlık Vidası Shim Screw Schraube für Unterlage	Sekman Ring Feder	Pul Stamp Ring	Anahtar Allen Key Inmenschenschlüssel								
	R	L	HF=H	B	LF	WF																
TTENN 2020 K16	●	○	20	20	125	10																
2525 M16	●	○	25	25	150	12.5									TNM. 1604..	ATK-01	AKV-01-M5x22	AATN-2-0002	AAV-03-M5x12	-	ABPL-01	AAL-03-3
3232 P16	●	○	32	32	170	16																
2525 M22	●	○	25	25	150	12.5	TNM. 2204..	ATK-02	AKV-30-M6x22	AATN-3-0015	AAV-02-M5x12	AS-01	ABPL-01	AAL-03-3								
3232 P22	●	○	32	32	170	16																
4040 S22	○	○	40	40	250	20																

R: Sağ / Right / Rechts L: Sol/Left/Links
● Stokta / In Stock / Auf Lager ○ Stokta Yok / Non Stock Item / Kein Lagerartikel, Lieferzeit auf Anfrage

Sipariş Örneği/Ordering Example/Bestellbeispiel
1 ad./pcs./stück TSSNR 2020 K12

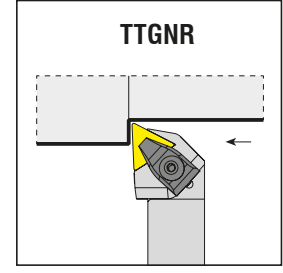
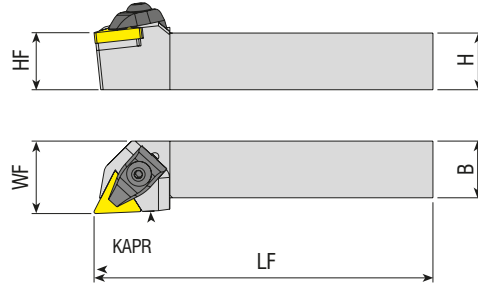

Takım Kodu Ordering Code Bestell-Bezeichnung	Stok Stock Lager		Takım Ölçüleri (mm) Dimension (mm) Abmessung (mm)				Kesici Uç Insert Wendeschneidplatte	Baskı Pabucu Wedge Clamp Spannpratze	Pabuç Vidası Clamp Screw Klemmschraube	Altlık Shim Unterlage	Altlık Vidası Shim Screw Schraube für Unterlage	Sekman Ring Feder	Pul Stamp Ring	Anahtar Allen Key Innerschloßschlüssel
	R	L	HF=H	B	LF	WF								
TTGNR/L 2020 K16	●	●	20	20	125	25	TNM. 1604..	ATK-01	AKV-01-M5x22	AATN-2-0002	AAV-03-M5x12	-	ABPL-01	AAL-03-3
2525 M16	●	●	25	25	150	32								
3232 P16	●	●	32	32	170	40								
2525 M22	●	●	25	25	150	32	TNM. 2204..	ATK-02	AKV-30-M6x22	AATN-3-0015	AAV-02-M5x12	AS-01		
3232 P22	●	●	32	32	170	40								
4040 S22	●	○	40	40	250	50								

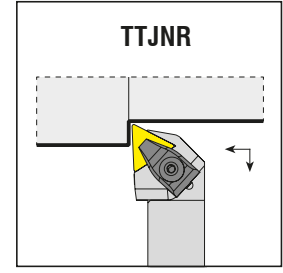
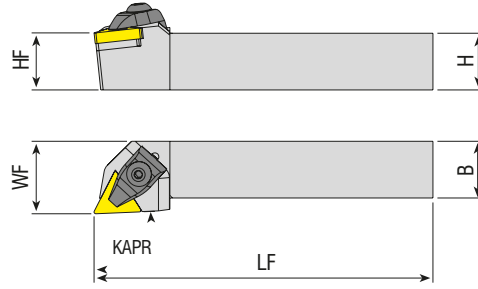
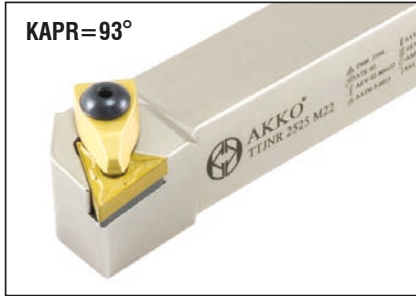

Takım Kodu Ordering Code Bestell-Bezeichnung	Stok Stock Lager		Takım Ölçüleri (mm) Dimension (mm) Abmessung (mm)				Kesici Uç Insert Wendeschneidplatte	Baskı Pabucu Wedge Clamp Spannpratze	Pabuç Vidası Clamp Screw Klemmschraube	Altlık Shim Unterlage	Altlık Vidası Shim Screw Schraube für Unterlage	Sekman Ring Feder	Pul Stamp Ring	Anahtar Allen Key Innerschloßschlüssel
	R	L	HF=H	B	LF	WF								
TTJNR/L 2020 K16	●	●	20	20	125	25	TNM. 1604..	ATK-01	AKV-01-M5x22	AATN-2-0002	AAV-03-M5x12	-	ABPL-01	AAL-03-3
2525 M16	●	●	25	25	150	32								
3232 P16	●	●	32	32	170	40								
2525 M22	●	●	25	25	150	32	TNM. 2204..	ATK-02	AKV-30-M6x22	AATN-3-0015	AAV-02-M5x12	AS-01		
3232 P22	●	●	32	32	170	40								
4040 S22	○	○	40	40	250	50								

R: Sağ / Right / Rechts L: Sol/Left/Links

● Stokta / In Stock / Auf Lager ○ Stokta Yok / Non Stock Item / Kein Lagerartikel, Lieferzeit auf Anfrage

Sipariş Örneği/Ordering Example/Bestellbeispiel

1 ad./pcs./stück TTGNR 2020 K16

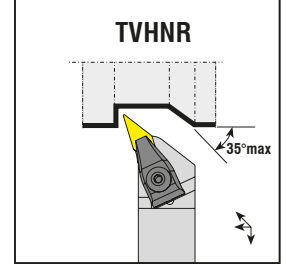
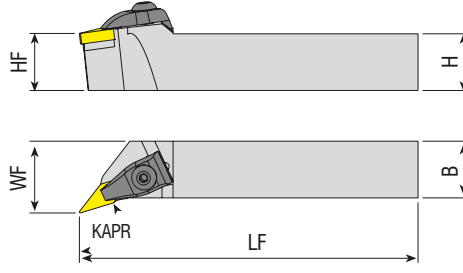

Takım Kodu Ordering Code Bestell-Bezeichnung	Stok Stock Lager		Takım Ölçüleri (mm) Dimension (mm) Abmessung (mm)				Kesici Uç Insert Wendescheidplatte	Baskı Pabucu Wedge Clamp Spannpratze	Pabuç Vidası Clamp Screw Klemmschraube	Altlık Shim Unterlage	Altlık Vidası Shim Screw Schraube für Unterlage	Sekman Ring Feder	Pul Stamp Ring	Anahtar Allen Key Inmenschenschlüssel
	R	L	HF=H	B	LF	WF								
TVHNR/L 2020 K16	●	●	20	20	125	25	VNM. 1604..	ATK-03	AKV-30-M6x22	AAVN-2-0002	AAV-04-M5x12	AS-01	ABPL-01	AAL-03-3
2525 M16	●	●	25	25	150	32								
3232 P16	●	●	32	32	170	40								

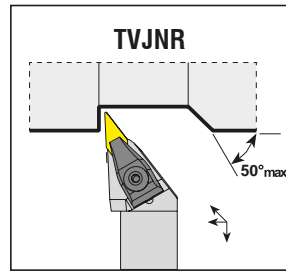
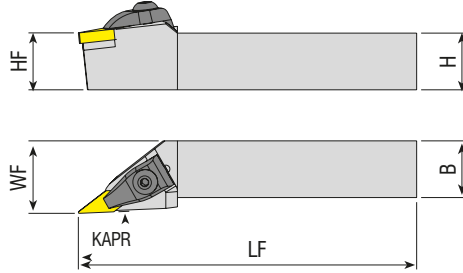

Takım Kodu Ordering Code Bestell-Bezeichnung	Stok Stock Lager		Takım Ölçüleri (mm) Dimension (mm) Abmessung (mm)				Kesici Uç Insert Wendescheidplatte	Baskı Pabucu Wedge Clamp Spannpratze	Pabuç Vidası Clamp Screw Klemmschraube	Altlık Shim Unterlage	Altlık Vidası Shim Screw Schraube für Unterlage	Sekman Ring Feder	Pul Stamp Ring	Anahtar Allen Key Inmenschenschlüssel
	R	L	HF=H	B	LF	WF								
TVJNR/L 2020 K16	●	●	20	20	125	25	VNM. 1604..	ATK-03	AKV-30-M6x22	AAVN-2-0002	AAV-04-M5x12	AS-01	ABPL-01	AAL-03-3
2525 M16	●	●	25	25	150	32								
3232 P16	●	●	32	32	170	40								

R: Sağ / Right / Rechts L: Sol/Left/Links
● Stokta / In Stock / Auf Lager ○ Stokta Yok / Non Stock Item / Kein Lagerartikel, Lieferzeit auf Anfrage

Sipariş Örneği/Ordering Example/Bestellbeispiel
1 ad./pcs./stück TVHNR 2020 K16

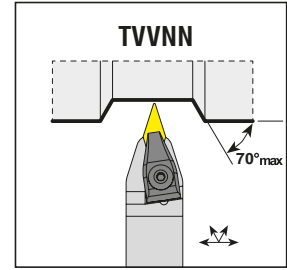
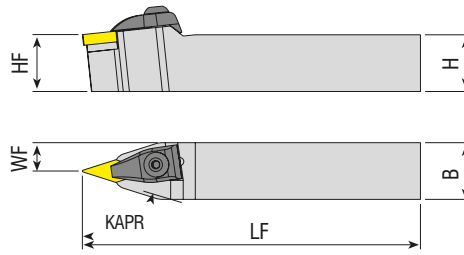

Takım Kodu Ordering Code Bestell-Bezeichnung	Stok Stock Lager		Takım Ölçüleri (mm) Dimension (mm) Abmessung (mm)				Kesici Uç Insert Wendeschneidplatte	Baskı Pabuçu Wedge Clamp Spannpratze	Pabuç Vidası Clamp Screw Klemmschraube	Altlık Shim Unterlage	Altlık Vidası Shim Screw Schraube für Unterlage	Sekman Ring Feder	Pul Stamp Ring	Anahtar Allen Key Inmenschlüsselschlüssel
	R	L	HF=H	B	LF	WF								
TVVNN 2020 K16	●		20	20	125	10	VNM. 1604..	ATK-03	AKV-30-M6x22	AAVN-2-0002	AAV-04-M5x12	AS-01	ABPL-01	AAL-03-3
2525 M16	●		25	25	150	12.5								
3232 P16	●		32	32	170	16								

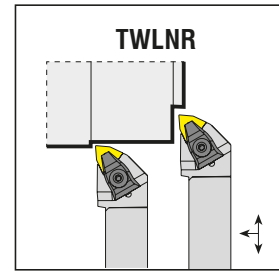
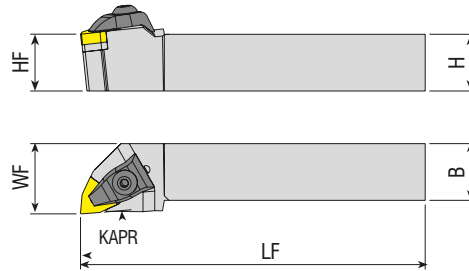

Takım Kodu Ordering Code Bestell-Bezeichnung	Stok Stock Lager		Takım Ölçüleri (mm) Dimension (mm) Abmessung (mm)				Kesici Uç Insert Wendeschneidplatte	Baskı Pabuçu Wedge Clamp Spannpratze	Pabuç Vidası Clamp Screw Klemmschraube	Altlık Shim Unterlage	Altlık Vidası Shim Screw Schraube für Unterlage	Sekman Ring Feder	Pul Stamp Ring	Anahtar Allen Key Inmenschlüsselschlüssel
	R	L	HF=H	B	LF	WF								
TWLNR/L 1616 H06	●	●	16	16	100	20	WNM. 0604..	ATK-01	AKV-01-M5x22	AAWN-SW317	AAV-01-M3x10	-	ABPL-01	AAL-03-3
2020 K06	●	●	20	20	125	25								
2525 M06	●	●	25	25	150	32								
2020 K08	●	●	20	20	125	25	WNM. 0804..	ATK-02	AKV-30-M6x22	AAWN-3-0001	AAV-02-M5x12	AS-01	ABPL-01	AAL-03-3
2525 M08	●	●	25	25	150	32								
3232 P08	●	●	32	32	170	40								
4040 S08	●	●	40	40	250	50								
5050 S08	○	○	50	50	250	63								

R: Sağ / Right / Rechts L: Sol/Left/Links

● Stokta / In Stock / Auf Lager ○ Stokta Yok / Non Stock Item / Kein Lagerartikel, Lieferzeit auf Anfrage

Sipariş Örneği/Ordering Example/Bestellbeispiel

1 ad./pcs./stück TVVNN 2020 K16



*konusulan
the spoken kalite...
quality...*

M-SİSTEM

M-SİSTEM DIŞ TORNA KATERLERİ
M-SYSTEM EXTERNAL TURNING TOOLHOLDERS
M-SYSTEM AUSSEN - DREHHALTER



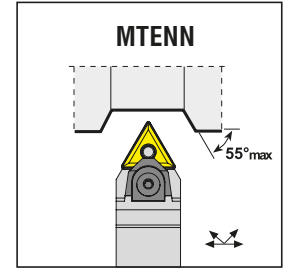
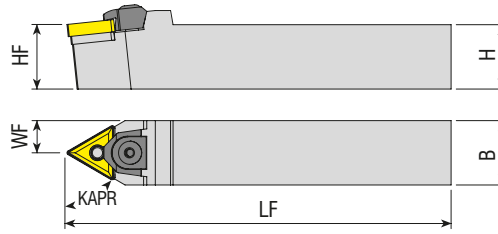

Takım Kodu Ordering Code Bestell-Bezeichnung	Stok Stock Lager		Takım Ölçüleri (mm) Dimension (mm) Abmessung (mm)				Kesici Uç Insert Wendeschneidplatte	Yedek Parçaları / Spare Parts / Ersatzteile						
	R	L	HF=H	B	LF	WF		Baskı Pabucu Wedge Clamp Spannpratze	Pabuç Vidası Clamp Screw Klemmschraube	Ahtık Shim Unterlage	Pim Pin Stift	Sekman Ring Feder	Pul Stamp Ring	Anahtar Allen Key Innensechskantschlüssel
MTENN 2020 K16	●		20	20	125	10	TNM. 1604..	AMK-04	AKV-30-M6x22	AATN-2-0002	APM-01	AS-01	ABPL-01	AAL-03-3
2525 M16	●		25	25	150	12.5								
3232 P16	●		32	32	170	16								
2525 M22	●		25	25	150	12.5	TNM. 2204..		AATN-3-0015	APM-02				
3232 P22	●		32	32	170	16								
4040 S22	●		40	40	250	20								

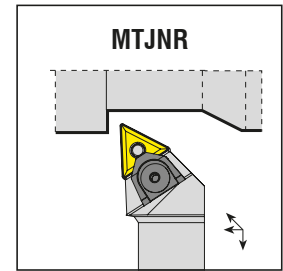
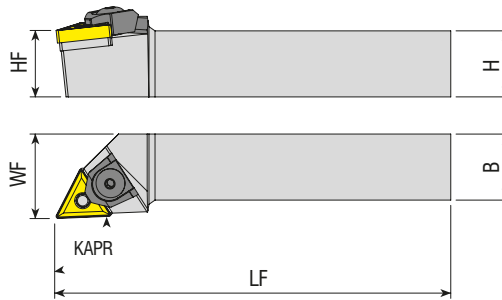
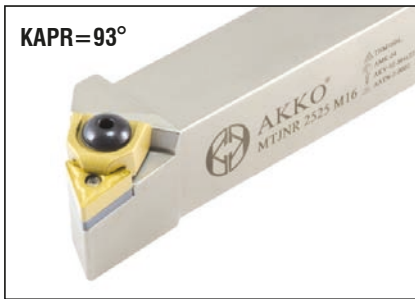

Takım Kodu Ordering Code Bestell-Bezeichnung	Stok Stock Lager		Takım Ölçüleri (mm) Dimension (mm) Abmessung (mm)				Kesici Uç Insert Wendeschneidplatte	Yedek Parçaları / Spare Parts / Ersatzteile						
	R	L	HF=H	B	LF	WF		Baskı Pabucu Wedge Clamp Spannpratze	Pabuç Vidası Clamp Screw Klemmschraube	Ahtık Shim Unterlage	Pim Pin Stift	Sekman Ring Feder	Pul Stamp Ring	Anahtar Allen Key Innensechskantschlüssel
MTJNR/L 2020 K16	●	●	20	20	125	25	TNM. 1604..	AMK-04	AKV-30-M6x22	AATN-2-0002	APM-01	AS-01	ABPL-01	AAL-03-3
2525 M16	●	●	25	25	150	32								
3232 P16	●	●	32	32	170	40								
2525 M22	●	●	25	25	150	32	TNM. 2204..		AATN-3-0015	APM-02				
3232 P22	●	●	32	32	170	40								
4040 S22	●	●	40	40	250	50								

R: Sağ / Right / Rechts L: Sol/Left/Links

● Stokta / In Stock / Auf Lager ○ Stokta Yok / Non Stock Item / Kein Lagerartikel, Lieferzeit auf Anfrage

Sipariş Örneği/Ordering Example/Bestellbeispiel

1 ad./pcs./stück MTENN 2020 K16

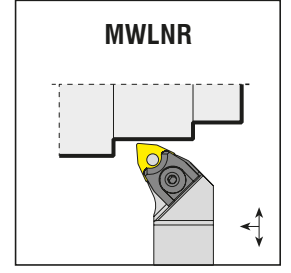
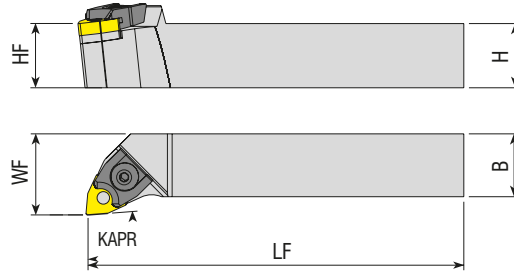

Takım Kodu Ordering Code Bestell-Bezeichnung	Stok Stock Lager		Takım Ölçüleri (mm) Dimension (mm) Abmessung (mm)				Kesici Uç Insert Wendeschneidplatte	Baskı Pabucu Wedge Clamp Spannpratze	Pabuç Vidası Clamp Screw Klemmschraube	Altık Shim Unterlage	Pim Pin Stift	Sekman Ring Feder	Pul Stamp Ring	Anahtar Allen Key Innensechskantschlüssel
	R	L	HF=H	B	LF	WF								
MWLNR/L 1616 H06	●	●	16	16	100	20			AKV-04-M5x17	-	APM-08	-	-	AAL-03-3
2020 K06	●	●	20	20	125	25								
2525 M06	●	●	25	25	150	32								
2020 K08	●	●	20	20	125	25								
2525 M08	●	●	25	25	150	32								
3232 P08	●	●	32	32	170	40	WNM. 0804..	AMK-05	AKV-03-M6x22	AAWN-3-0001	APM-02	AS-01	ABPL-01	

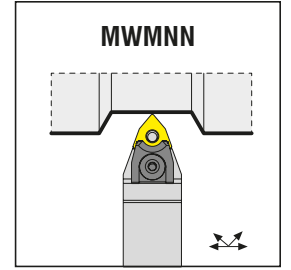
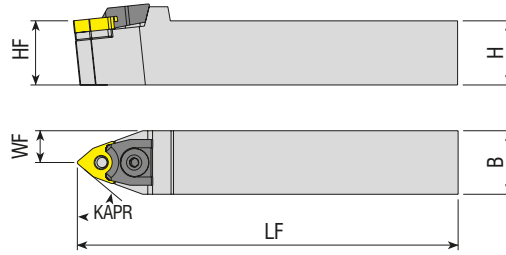

Takım Kodu Ordering Code Bestell-Bezeichnung	Stok Stock Lager		Takım Ölçüleri (mm) Dimension (mm) Abmessung (mm)				Kesici Uç Insert Wendeschneidplatte	Baskı Pabucu Wedge Clamp Spannpratze	Pabuç Vidası Clamp Screw Klemmschraube	Altık Shim Unterlage	Pim Pin Stift	Sekman Ring Feder	Pul Stamp Ring	Anahtar Allen Key Innensechskantschlüssel
	R	L	HF=H	B	LF	WF								
MWMNN 1616 H06	●	●	16	16	100	8			AKV-04-M5x17	-	APM-08	-	-	AAL-03-3
2020 K06	●	●	20	20	125	10								
2525 M06	●	●	25	25	150	12.5								
2020 K08	●	●	20	20	125	10								
2525 M08	●	●	25	25	150	12.5								
3232 P08	●	●	32	32	170	16	WNM. 0804..	AMK-05	AKV-03-M6x22	AAWN-3-0001	APM-02	AS-01	ABPL-01	

R: Sağ / Right / Rechts L: Sol/Left/Links
● Stokta / In Stock / Auf Lager ○ Stokta Yok / Non Stock Item / Kein Lagerartikel, Lieferzeit auf Anfrage

Sipariş Örneği/Ordering Example/Bestellbeispiel
1 ad./pcs./stück MWLNR 1616 H06

P-SİSTEM

P-SİSTEM DIŞ TORNA KATERLERİ
P-SYSTEM EXTERNAL TURNING TOOLHOLDERS
P-SYSTEM AUSSEN - DREHHALTER

konusulan
the spoken kalite...
quality...



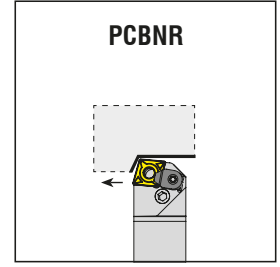
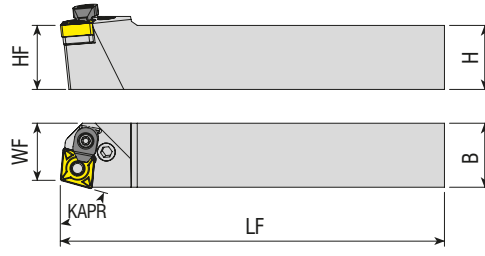

Takım Kodu
Ordering Code
Bestell-Bezeichnung

Takım Kodu Ordering Code Bestell-Bezeichnung	Stok Stock Lager		Takım Ölçüleri (mm) Dimension (mm) Abmessung (mm)				Kesici Uç Insert Wendeschneidplatte	Yedek Parçaları / Spare Parts / Ersatzteile								
	R	L	HF=H	B	LF	WF		Leyve Lever Kniehebel	Leyve Vidası Lever Screw Kniehebelschraube	Altlık Shim Unterlage	Altlık Yay Shim Spring Feder für Unterlage	Baskı Parçası Wedge Clamp Spannpratze	Baskı Vidası Clamp Screw Klemmschraube	Anahtar Allen Key Innerschraubenschlüssel		
PCBNR/L 2020 K12C	●	●	20	20	125	17.5										
2525 M12C	●	●	25	25	150	22.5	CNM. 1204..	APL-02	ALV-03-M8x19	AACN-3-0001	AAY-02	ACK-05	4015-M4x11	AAL-03-3		
3232 P12C	●	●	32	32	170	29.5										
2525 M16C	●	●	25	25	150	22	CNM. 1606..	APL-04	ALV-04-M8x22	AACN-3-0002	AAY-03					
3232 P16C	●	●	32	32	170	27										
3232 P19C	●	●	32	32	170	27	CNM. 1906..	APL-05	ALV-05-M10x27	AACN-3-0003	AAY-04	ACK-09	AAV-05-M6x15	AAL-05-4		
4040 S19C	●	●	40	40	250	37										
4040 S25C	●	●	40	40	250	37	CNM. 2509..	APL-06	ALV-06-M12x36	AACN-3-0008	AAY-05	ACK-04	AKV-16-M6x16	AAL-07-5		
5050 S25C	○	○	50	50	250	47										

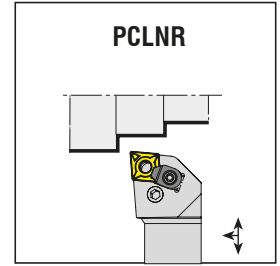
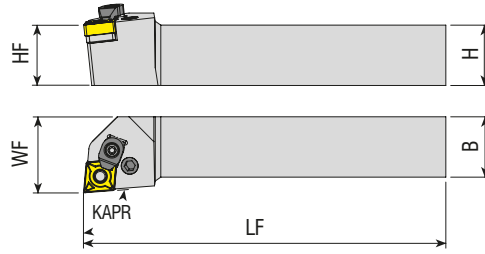
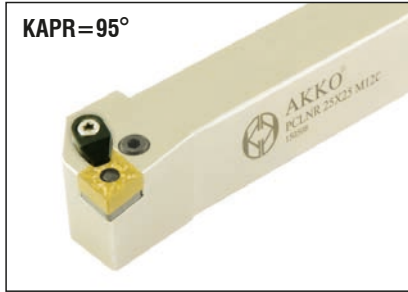

Takım Kodu
Ordering Code
Bestell-Bezeichnung

Takım Kodu Ordering Code Bestell-Bezeichnung	Stok Stock Lager		Takım Ölçüleri (mm) Dimension (mm) Abmessung (mm)				Kesici Uç Insert Wendeschneidplatte	Yedek Parçaları / Spare Parts / Ersatzteile								
	R	L	HF=H	B	LF	WF		Leyve Lever Kniehebel	Leyve Vidası Lever Screw Kniehebelschraube	Altlık Shim Unterlage	Altlık Yay Shim Spring Feder für Unterlage	Baskı Parçası Wedge Clamp Spannpratze	Baskı Vidası Clamp Screw Klemmschraube	Anahtar Allen Key Innerschraubenschlüssel		
PCLNR/L 1616 H09	●	●	16	16	100	20										
2020 K09	●	●	20	20	125	25	CNM. 0903..	APL-01	ALV-02-M6x17	AACN-2-0002	AAY-01	-	-	AAL-02-2.5		
2525 M09	●	●	25	25	150	32										
1616 H12	●	●	16	16	100	20										
2020 K12C	●	●	20	20	125	25	CNM. 1204..	APL-02	ALV-03-M8x19	AACN-3-0001	AAY-02	ACK-05	4015-M4x11	AAL-03-3		
2525 M12C	●	●	25	25	150	32										
3232 P12C	●	●	32	32	170	40										
2525 M16C	●	●	25	25	150	32	CNM. 1606..	APL-04	ALV-04-M8x22	AACN-3-0002	AAY-03					
3232 P16C	●	●	32	32	170	40										
2525 M19C	●	●	25	25	150	32										
3232 P19C	●	●	32	32	170	40	CNM. 1906..	APL-05	ALV-05-M10x27	AACN-3-0003	AAY-04	ACK-09	AAV-05-M6x15	AAL-05-4		
4040 S19C	●	●	40	40	250	50										
4040 S25C	●	●	40	40	250	50	CNM. 2509..	APL-06	ALV-06-M12x36	AACN-3-0008	AAY-05	ACK-04	AKV-16-M6x16	AAL-07-5		
5050 S25C	●	●	50	50	250	60										

R: Sağ / Right / Rechts L: Sol/Left/Links

● Stokta / In Stock / Auf Lager ○ Stokta Yok / Non Stock Item / Kein Lagerartikel, Lieferzeit auf Anfrage

Sipariş Örneği/Ordering Example/Bestellbeispiel

1 ad./pcs./stück PCBNR 2020 K12C

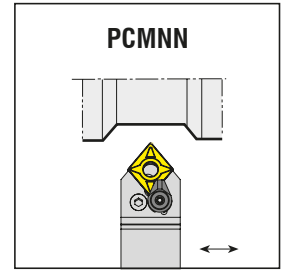
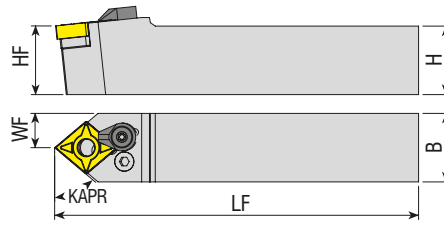

Takım Kodu Ordering Code Bestell-Bezeichnung	Stok Stock Lager		Takım Ölçüleri (mm) Dimension (mm) Abmessung (mm)				Kesici Uç Insert Wendeschneidplatte	Levyeye Lever Kniehebel	Levyeye Vidası Lever Screw Kniehebelschraube	Altılık Shim Unterlage	Altılık Yayısı Shim Spring Feder für Unterlage	Baskı Parçası Wedge Clamp Spannpratze	Baskı Vidası Clamp Screw Klemmschraube	Anahtar Allen Key Innensechskantschlüssel
	R	L	HF=H	B	LF	WF								
PCMNN 2020 K12C	●		20	20	125	10	CNM. 1204..	APL-02	ALV-03-M8x19	AACN-3-0001	AAY-02	ACK-05	4015-M4x11	AAL-03-3
2525 M12C	●		25	25	150	12.5								
3232 P12C	○		32	32	170	16								
2525 M16C	○		25	25	150	12.5	CNM. 1606..	APL-04	ALV-04-M8x22	AACN-3-0002	AAY-03	ACK-09	AAV-05-M6x15	AAL-05-4
3232 P16C	○		32	32	170	16								
3232 P19C	●		32	32	170	16								
4040 S19C	●		40	40	250	20	CNM. 1906..	APL-05	ALV-05-M10x27	AACN-3-0003	AAY-04	ACK-09	AAV-05-M6x15	AAL-05-4
5050 S19C	○		50	50	250	25								
4040 S25C	●		40	40	250	20	CNM. 2509..	APL-06	ALV-06-M12x36	AACN-3-0008	AAY-05	ACK-04	AKV-16-M6x16	AAL-07-5

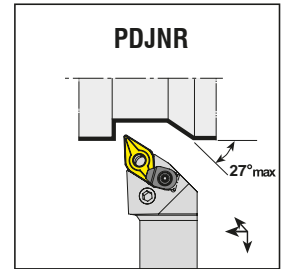
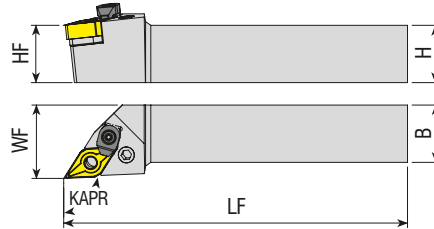

Takım Kodu Ordering Code Bestell-Bezeichnung	Stok Stock Lager		Takım Ölçüleri (mm) Dimension (mm) Abmessung (mm)				Kesici Uç Insert Wendeschneidplatte	Levyeye Lever Kniehebel	Levyeye Vidası Lever Screw Kniehebelschraube	Altılık Shim Unterlage	Altılık Yayısı Shim Spring Feder für Unterlage	Baskı Parçası Wedge Clamp Spannpratze	Baskı Vidası Clamp Screw Klemmschraube	Anahtar Allen Key Innensechskantschlüssel
	R	L	HF=H	B	LF	WF								
PDJNR/L 1616 H11	●	●	16	16	100	20	DNM. 1104..	APL-01	ALV-02-M6x17	AADN-SD317	AAY-01	-	-	AAL-02-2.5
2020 K11	●	●	20	20	125	25								
2525 M11	●	●	25	25	150	32								
2020 K15C	●	●	20	20	125	25	DNM. 1506..	APL-03	ALV-03-M8x19	AADN-3-0001	AAY-02	ACK-05	4015-M4x11	AAL-03-3
2525 M15C	●	●	25	25	150	32								
3232 P15C	●	●	32	32	170	40								
4040 S15C	●	●	40	40	250	50								

R: Sağ / Right / Rechts L: Sol/Left/Links

● Stokta / In Stock / Auf Lager ○ Stokta Yok / Non Stock Item / Kein Lagerartikel, Lieferzeit auf Anfrage

Sipariş Örneği/Ordering Example/Bestellbeispiel

1 ad./pcs./stück PCMNN 2020 K12C

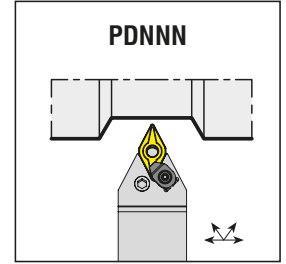
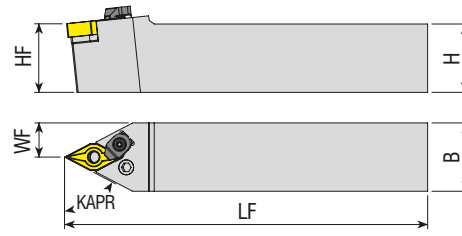

Takım Kodu Ordering Code Bestell-Bezeichnung	Stok Stock Lager		Takım Ölçüleri (mm) Dimension (mm) Abmessung (mm)				Kesici Uç Insert Wendescheidplatte	Yedek Parçaları / Spare Parts / Ersatzteile						
	R	L	HF=H	B	LF	WF		Levye Lever Kniehebel	Levye Vidası Lever Screw Kniehebelschraube	Altılık Shim Unterlage	Altılık Yayı Shim Spring Feder für Unterlage	Baskı Parçası Wedge Clamp Spannpratze	Baskı Vidası Clamp Screw Klemmschraube	Anahtar Allen Key Innerschlüsselschlüssel
PDNNA 1616 H11	●		16	16	100	8								
2020 K11	●		20	20	125	10	DNM. 1104..	APL-01	ALV-02-M6x17	AADN-SD317	AAY-01	-	-	AAL-02-2.5
2525 M11	●		25	25	150	12.5								
2020 K15C	●		20	20	125	10								
2525 M15C	●		25	25	150	12.5	DNM. 1506..	APL-03	ALV-03-M8x19	AADN-3-0001	AAY-02	ACK-05	4015-M4x11	AAL-03-3
3232 P15C	●		32	32	170	16								

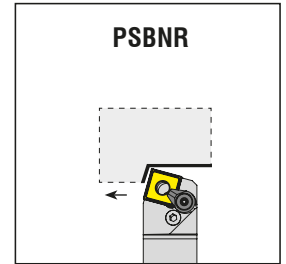
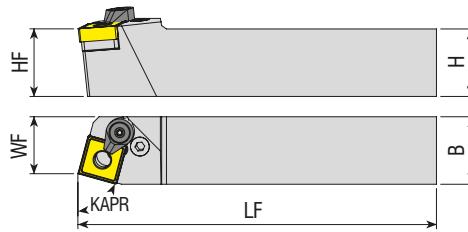

Takım Kodu Ordering Code Bestell-Bezeichnung	Stok Stock Lager		Takım Ölçüleri (mm) Dimension (mm) Abmessung (mm)				Kesici Uç Insert Wendescheidplatte	Yedek Parçaları / Spare Parts / Ersatzteile						
	R	L	HF=H	B	LF	WF		Levye Lever Kniehebel	Levye Vidası Lever Screw Kniehebelschraube	Altılık Shim Unterlage	Altılık Yayı Shim Spring Feder für Unterlage	Baskı Parçası Wedge Clamp Spannpratze	Baskı Vidası Clamp Screw Klemmschraube	Anahtar Allen Key Innerschlüsselschlüssel
PSBNR/L 1616 H09	●	●	16	16	100	13								
2020 K09	○	○	20	20	125	17	SNM. 0903..	APL-01	ALV-02-M6x17	AASN-2-0002	AAY-01	-	-	AAL-02-2.5
2020 K12	●	●	20	20	125	17								
2525 M12C	●	●	25	25	150	22	SNM. 1204..	APL-02	ALV-03-M8x19	AASN-3-0004	AAY-02	ACK-05	4015-M4x11	AAL-03-3
3232 P12C	●	●	32	32	170	27								
2525 M15	●	●	25	25	150	22	SNM. 1506..	APL-04	ALV-04-M8x22	AASN-3-0023	AAY-03	-	-	
3232 P15C	●	●	32	32	170	27								
3232 P19C	●	●	32	32	170	27	SNM. 1906..	APL-05	ALV-05-M10x27	AASN-3-0005	AAY-04	ACK-09	AAV-05-M6x15	AAL-05-4
4040 S19C	●	●	40	40	250	35								
4040 S25C	●	●	40	40	250	35	SNM. 2509..	APL-06	ALV-06-M12x36	AASN-3-0020	AAY-05	ACK-04	AKV-16-M6x16	AAL-07-5
5050 S25C	●	○	50	50	250	43								

R: Sağ / Right / Rechts L: Sol/Left/Links

● Stokta / In Stock / Auf Lager ○ Stokta Yok / Non Stock Item / Kein Lagerartikel, Lieferzeit auf Anfrage

Sipariş Örneği/Ordering Example/Bestellbeispiel

1 ad./pcs./stück PDNNA 1616 H11

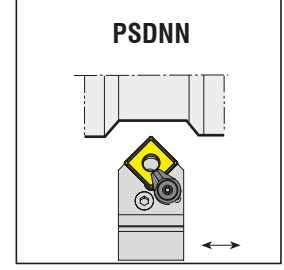
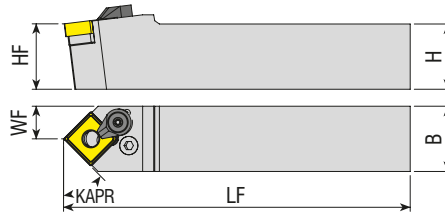

Takım Kodu Ordering Code Bestell-Bezeichnung	Stok Stock Lager		Takım Ölçüleri (mm) Dimension (mm) Abmessung (mm)				Kesici Uç Insert Wendeschneidplatte	Levyeye Lever Kniehebel	Levyeye Vidası Lever Screw Kniehebelschraube	Altılık Shim Unterlage	Altılık Yay Shim Spring Feder für Unterlage	Baskı Parçası Wedge Clamp Spannpratze	Baskı Vidası Clamp Screw Klemmschraube	Anahtar Allen Key Innerschlüssel
	HF=H	B	LF	WF										
PSDNN 1616 H09	●		16	16	100	8						-	-	AAL-02-2.5
2020 K12C	●		20	20	125	10								
2525 M12C	●		25	25	150	12.5	SNM. 1204..							AAL-03-3
3232 P12C	●		32	32	170	16								
2020 K15C	○		20	20	125	10	SNM. 1506..							
2525 M15C	●		25	25	150	12.5								
3232 P19C	●		32	32	170	16								
4040 S19C	○		40	40	250	20	SNM. 1906..							AAL-05-4
5050 S19C	○		50	50	250	25								
4040 S25C	●		40	40	250	20	SNM. 2509..							AAL-07-5
5050 S25C	○		50	50	250	25								

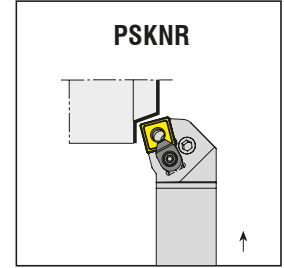
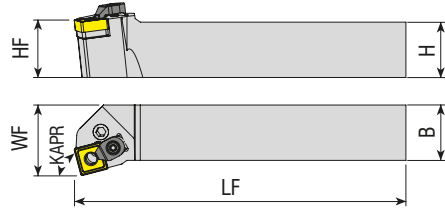

Takım Kodu Ordering Code Bestell-Bezeichnung	Stok Stock Lager		Takım Ölçüleri (mm) Dimension (mm) Abmessung (mm)				Kesici Uç Insert Wendeschneidplatte	Levyeye Lever Kniehebel	Levyeye Vidası Lever Screw Kniehebelschraube	Altılık Shim Unterlage	Altılık Yay Shim Spring Feder für Unterlage	Baskı Parçası Wedge Clamp Spannpratze	Baskı Vidası Clamp Screw Klemmschraube	Anahtar Allen Key Innerschlüssel
	R	L	HF=H	B	LF	WF								
PSKNR/L 2020 K09	●	○	20	20	125	25	SNM. 0903..					-	-	AAL-02-2.5
2020 K12C	●	●	20	20	125	25								
2525 M12C	●	●	25	25	150	32	SNM. 1204..							AAL-03-3
3232 P12C	●	●	32	32	170	40								
2525 M15C	●	●	25	25	150	32	SNM. 1506..							
3232 P15C	●	●	32	32	170	40								
3232 P19C	●	●	32	32	170	40	SNM. 1906..							AAL-05-4
4040 S19C	●	●	40	40	250	50								
4040 S25C	●	●	40	40	250	50	SNM. 2509..							AAL-07-5
5050 S25C	●	○	50	50	250	60								

R: Sağ / Right / Rechts L: Sol/Left/Links

● Stokta / In Stock / Auf Lager ○ Stokta Yok / Non Stock Item / Kein Lagerartikel, Lieferzeit auf Anfrage

Sipariş Örneği/Ordering Example/Bestellbeispiel

1 ad./pcs./stück PSDNN 1616 H09

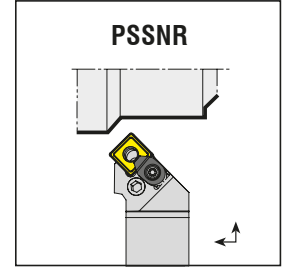
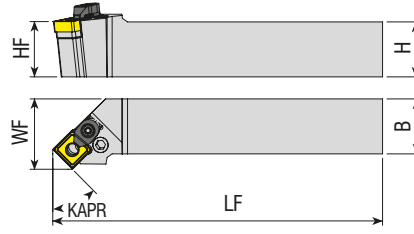

Takım Kodu Ordering Code Bestell-Bezeichnung	Stok Stock Lager		Takım Ölçüleri (mm) Dimension (mm) Abmessung (mm)				Kesici Uç Insert Wendeschneidplatte	Yedek Parçaları / Spare Parts / Ersatzteile						
	R	L	HF=H	B	LF	WF		Levyeye Lever Kniehebel	Levyeye Vidası Lever Screw Kniehebelschraube	Aitlik Shim Unterlage	Aitlik Yayı Shim Spring Feder für Unterlage	Baskı Parçası Wedge Clamp Spannpratze	Baskı Vidası Clamp Screw Klemmschraube	Anahtar Allen Key Innerschlüsselschlüssel
PSSNR/L 1616 H09	●	●	16	16	100	20	SNM. 0903..	APL-01	ALV-02-M6x17	AASN-2-0002	AAV-01	-	-	AAL-02-2.5
2020 K09	●	○	20	20	125	25								
2020 K12C	●	●	20	20	125	25	SNM. 1204..	APL-02	ALV-03-M8x19	AASN-3-0004	AAV-02	ACK-05	4015-M4x11	AAL-03-3
2525 M12C	●	●	25	25	150	32								
3232 P12C	●	●	32	32	170	40	SNM. 1506..	APL-04	ALV-04-M8x22	AASN-3-0023	AAV-03	ACK-09	AAV-05-M6x15	AAL-05-4
3232 P15C	●	○	32	32	170	40								
3232 P19C	●	●	32	32	170	40	SNM. 1906..	APL-05	ALV-05-M10x27	AASN-3-0005	AAV-04	ACK-09	AAV-05-M6x15	AAL-05-4
4040 S19C	●	●	40	40	250	50								
4040 S25C	●	●	40	40	250	50	SNM. 2509..	APL-06	ALV-06-M12x36	AASN-3-0020	AAV-05	ACK-04	AKV-16-M6x16	AAL-07-5

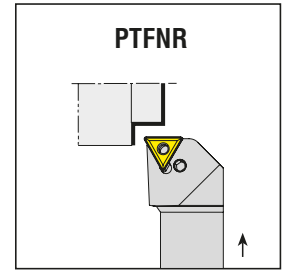
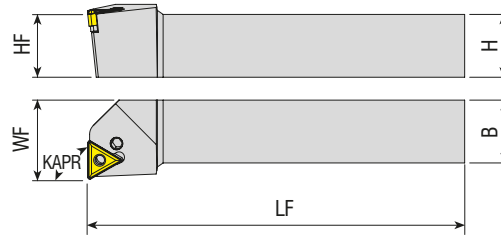

Takım Kodu Ordering Code Bestell-Bezeichnung	Stok Stock Lager		Takım Ölçüleri (mm) Dimension (mm) Abmessung (mm)				Kesici Uç Insert Wendeschneidplatte	Yedek Parçaları / Spare Parts / Ersatzteile						
	R	L	HF=H	B	LF	WF		Levyeye Lever Kniehebel	Levyeye Vidası Lever Screw Kniehebelschraube	Aitlik Shim Unterlage	Aitlik Yayı Shim Spring Feder für Unterlage	Baskı Parçası Wedge Clamp Spannpratze	Baskı Vidası Clamp Screw Klemmschraube	Anahtar Allen Key Innerschlüsselschlüssel
PTFNR/L 1616 H16	●	●	16	16	100	20	TNM. 1604..	APL-01	ALV-02-M6x17	AATN-3-0025	AAV-01	-	-	AAL-02-2.5
2020 K16	●	●	20	20	125	25								
2525 M16	●	●	25	25	150	32								
3232 P16	●	●	32	32	170	40	TNM. 2204..	APL-02	ALV-03-M8x19	AATN-3-0015	AAV-02	ACK-05	4015-M4x11	AAL-03-3
2525 M22C	●	●	25	25	150	32								
3232 P22C	●	●	32	32	170	40	TNM. 2706.	07042709	07042710	07042701	07042711	-	-	AAL-05-4
4040 S27	○	○	40	40	250	50								

R: Sağ / Right / Rechts L: Sol/Left/Links

● Stokta / In Stock / Auf Lager ○ Stokta Yok / Non Stock Item / Kein Lagerartikel, Lieferzeit auf Anfrage

Sipariş Örneği/Ordering Example/Bestellbeispiel

1 ad./pcs./stück PSSNR 1616 H09

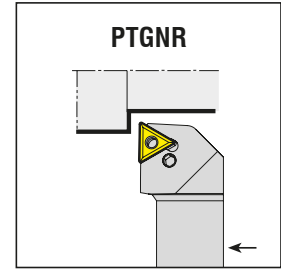
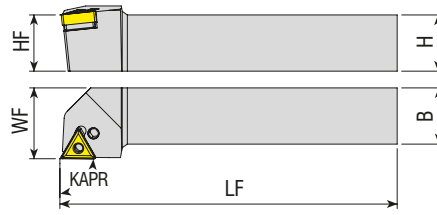

Takım Kodu Ordering Code Bestell-Bezeichnung	Stok Stock Lager		Takım Ölçüleri (mm) Dimension (mm) Abmessung (mm)				Kesici Uç Insert Wendeschneidplatte	Yedek Parçaları / Spare Parts / Ersatzteile								
	R	L	HF=H	B	LF	WF		Levye Lever Kniehebel	Levye Vidası Lever Screw Kniehebelschraube	Altılık Shim Unterlage	Altılık Yay Shim Spring Feder für Unterlage	Baskı Parçası Wedge Clamp Spannpratze	Baskı Vidası Clamp Screw Klemmschraube	Anahtar Allen Key Innerschraubschlüssel		
	○	○														
PTGNR/L 1010 E11	○	○	10	10	70	12	TNM. 1103..		07041109	07041110	-	-	-	-	-	-
1212 F11	○	○	12	12	80	16										
1616 H11	○	○	16	16	100	20										
1616 H16	●	●	16	16	100	20	TNM. 1604..	APL-01	ALV-02-M6x17	AATN-3-0025	AAY-01	-	-	-	-	AAL-02-2.5
2020 K16	●	●	20	20	125	25										
2525 M16	●	●	25	25	150	32										
3232 P16	○	○	32	32	170	40	TNM. 2204..	APL-02	ALV-03-M8x19	AATN-3-0015	AAY-02	ACK-05	4015-M4x11	-	-	AAL-03-3
2525 M22C	●	●	25	25	150	32										
3232 P22C	●	●	32	32	170	40										
4040 S27	○	○	40	40	250	50	TNM. 2706..	07042709	07042710	07042701	07042711	-	-	-	-	AAL-05-4

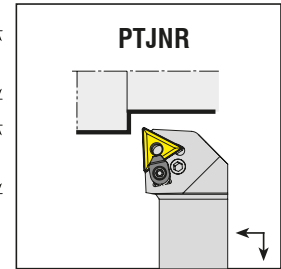
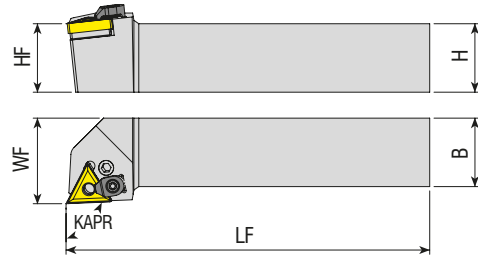

Takım Kodu Ordering Code Bestell-Bezeichnung	Stok Stock Lager		Takım Ölçüleri (mm) Dimension (mm) Abmessung (mm)				Kesici Uç Insert Wendeschneidplatte	Yedek Parçaları / Spare Parts / Ersatzteile									
	R	L	HF=H	B	LF	WF		Levye Lever Kniehebel	Levye Vidası Lever Screw Kniehebelschraube	Altılık Shim Unterlage	Altılık Yay Shim Spring Feder für Unterlage	Baskı Parçası Wedge Clamp Spannpratze	Baskı Vidası Clamp Screw Klemmschraube	Anahtar Allen Key Innerschraubschlüssel			
	○	○															
PTJNR/L 1010 E11	○	○	10	10	70	12	TNM. 1103..		07041109	07041110	-	-	-	-	-	-	-
1212 F11	○	○	12	12	80	16											
1616 H11	○	○	16	16	100	20											
1616 H16	●	●	16	16	100	20	TNM. 1604..	APL-01	ALV-02-M6x17	AATN-3-0025	AAY-01	-	-	-	-	AAL-02-2.5	
2020 K16	●	●	20	20	125	25											
2525 M16	●	●	25	25	150	32											
3232 P16	●	●	32	32	170	40	TNM. 2204..	APL-02	ALV-03-M8x19	AATN-3-0015	AAY-02	ACK-05	4015-M4x11	-	-	AAL-03-3	
2525 M22C	●	●	25	25	150	32											
3232 P22C	●	●	32	32	170	40											
4040 S27	●	○	40	40	250	50	TNM. 2706..	APL-05	ALV-05-M10x27	07042701	AAY-04	ACK-09	AAV-05-M6x15	-	-	AAL-05-4	

R: Sağ / Right / Rechts L: Sol/Left/Links

● Stokta / In Stock / Auf Lager ○ Stokta Yok / Non Stock Item / Kein Lagerartikel, Lieferzeit auf Anfrage

Sipariş Örneği/Ordering Example/Bestellbeispiel

1 ad./pcs./stück PTGNR 1010 E11

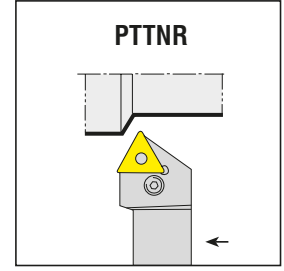
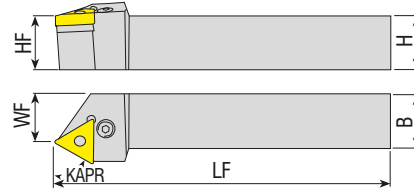

Takım Kodu Ordering Code Bestell-Bezeichnung	Stok Stock Lager		Takım Ölçüleri (mm) Dimension (mm) Abmessung (mm)				Kesici Uç Insert Wendeschneidplatte	Yedek Parçaları / Spare Parts / Ersatzteile								
	R	L	HF=H	B	LF	WF		Levye Lever Kniehebel	Levye Vidası Lever Screw Kniehebelschraube	Altılık Shim Unterlage	Altılık Yay Shim Spring Feder für Unterlage	Baskı Parçası Wedge Clamp Spannpratze	Baskı Vidası Clamp Screw Klemmschraube	Anahtar Allen Key Innerschraubschlüssel		
PTTNR/L 1616 H16	●	●	16	16	100	13	TNM. 1604..	APL-01	ALV-02-M6x17	AATN-3-0025	AAY-01	-	-	AAL-02-2.5		
2020 K16	●	●	20	20	125	17										
2525 M16	●	●	25	25	150	21.5										
3232 P16	●	●	32	32	170	31										
2525 M22C	●	●	25	25	150	20.5	TNM. 2204..	APL-02	ALV-03-M8x19	AATN-3-0015	AAY-02	ACK-05	4015-M4x11	AAL-03-3		
3232 P22C	●	●	32	32	170	29										

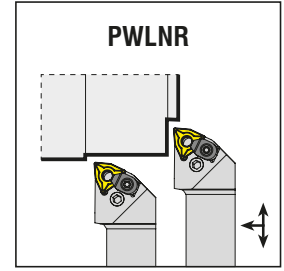
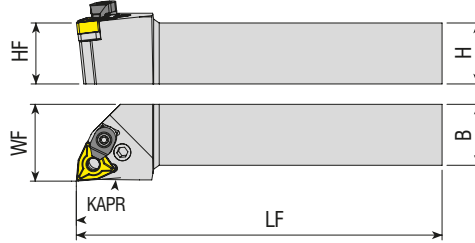

Takım Kodu Ordering Code Bestell-Bezeichnung	Stok Stock Lager		Takım Ölçüleri (mm) Dimension (mm) Abmessung (mm)				Kesici Uç Insert Wendeschneidplatte	Yedek Parçaları / Spare Parts / Ersatzteile								
	R	L	HF=H	B	LF	WF		Levye Lever Kniehebel	Levye Vidası Lever Screw Kniehebelschraube	Altılık Shim Unterlage	Altılık Yay Shim Spring Feder für Unterlage	Baskı Parçası Wedge Clamp Spannpratze	Baskı Vidası Clamp Screw Klemmschraube	Anahtar Allen Key Innerschraubschlüssel		
PWLNR/L 1616 H06	●	●	16	16	100	20	WNM. 0604..	APL-01	ALV-02-M6x17	AAWN-SW317	AAY-01	-	-	AAL-02-2.5		
2020 K06	●	●	20	20	125	25										
2525 M06	●	●	25	25	150	32										
3232 P06	○	○	32	32	170	40										
1616 H08	●	●	16	16	100	20	WNM. 0804..	APL-02	ALV-03-M8x19	AAWN-3-0001	AAY-02	ACK-05	4015-M4x11	AAL-03-3		
2020 K08C	●	●	20	20	125	25										
2525 M08C	●	●	25	25	150	32										
3232 P08C	●	●	32	32	170	40										

R: Sağ / Right / Rechts L: Sol/Left/Links

● Stokta / In Stock / Auf Lager ○ Stokta Yok / Non Stock Item / Kein Lagerartikel, Lieferzeit auf Anfrage

Sipariş Örneği/Ordering Example/Bestellbeispiel

1 ad./pcs./stück PTTNR 1616 H16



C-SİSTEM

C-SİSTEM DIŞ TORNA KATERLERİ
C-SYSTEM EXTERNAL TURNING TOOLHOLDERS
C-SYSTEM AUSSEN - DREHHALTER

konusulan
the spoken kalite...
quality...



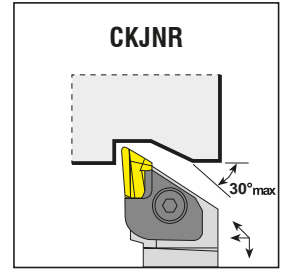
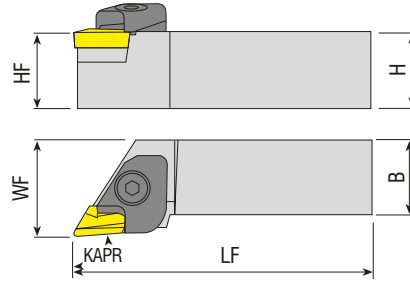

Takım Kodu
Ordering Code
Bestell-Bezeichnung

Stok Stock Lager		Takım Ölçüleri (mm) Dimension (mm) Abmessung (mm)				Kesici Uç Insert Wendeschneidplatte	Baskı Pabucu Wedge Clamp Spannpratze	Pabuç Vidası Clamp Screw Klemmschraube	Altlık Shim Unterlage	Altlık Vidası Shim Screw Schraube für Unterlage	Yay Spring Feder	Pul Stamp Ring	Anahtar Allen Key Innerschloßschlüssel
R	L	HF=H	B	LF	WF								
●	●	20	20	125	27.5	KNUX 1604..	ACK-01-R ACK-02-L	AKV-06-M6x20	AKS-16-R AKS-16-L	AAV-01-M3x10	AKY-02	ABPL-01	AAL-05-4
●	●	25	25	150	31.5								
●	●	32	32	170	40								
●	●	40	40	250	50								

Yedek Parçaları / Spare Parts / Ersatzteile

R: Sağ / Right / Rechts L: Sol/Left/Links

● Stokta / In Stock / Auf Lager ○ Stokta Yok / Non Stock Item / Kein Lagerartikel, Lieferzeit auf Anfrage

Sipariş Örneği/Ordering Example/Bestellbeispiel

1 ad./pcs./stück CKJNR 2020 K16



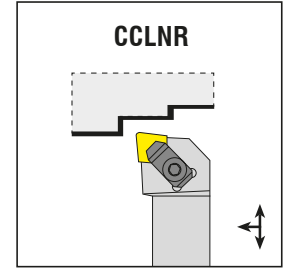
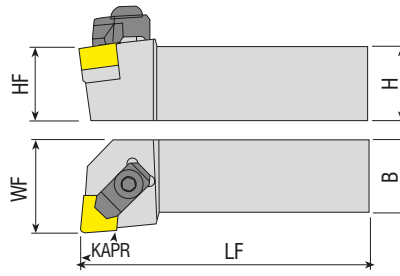

Takım Kodu Ordering Code Bestell-Bezeichnung	Stok Stock Lager		Takım Ölçüleri (mm) Dimension (mm) Abmessung (mm)				Kesici Uç Insert Wendeschneidplatte	Yedek Parçaları / Spare Parts / Ersatzteile					
	R	L	HF=H	B	LF	WF		Baskı Pabucu Wedge Clamp Spannpratze	Pabuç Vidası Clamp Screw Klemmschraube	Aitlik Shim Unterlage	Aitlik Vidası Shim Screw Schraube für Unterlage	Sekman Ring Feder	Anahtar Allen Key Inmenschenschlüssel
CCLNR/L 2525 M1207C	●	●	25	25	150	32	CN.N 1207..						
3232 P1207C	●	●	32	32	170	40							
2525 M1607C	●	●	25	25	150	32							

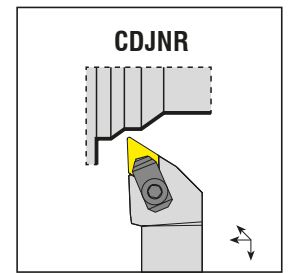
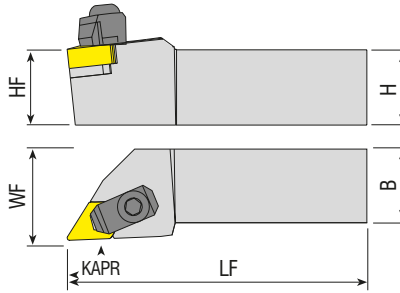

Takım Kodu Ordering Code Bestell-Bezeichnung	Stok Stock Lager		Takım Ölçüleri (mm) Dimension (mm) Abmessung (mm)				Kesici Uç Insert Wendeschneidplatte	Yedek Parçaları / Spare Parts / Ersatzteile					
	R	L	HF=H	B	LF	WF		Baskı Pabucu Wedge Clamp Spannpratze	Pabuç Vidası Clamp Screw Klemmschraube	Aitlik Shim Unterlage	Aitlik Vidası Shim Screw Schraube für Unterlage	Sekman Ring Feder	Anahtar Allen Key Inmenschenschlüssel
CDJNR/L 2525 M1107C	●	●	25	25	150	32	DN.N 1107..						
2525 M1507C	●	●	25	25	150	32							
3232 P1507C	●	●	32	32	170	40							

R: Sağ / Right / Rechts L: Sol/Left/Links

● Stokta / In Stock / Auf Lager ○ Stokta Yok / Non Stock Item / Kein Lagerartikel, Lieferzeit auf Anfrage

Sipariş Örneği/Ordering Example/Bestellbeispiel

1 ad./pcs./stück CCLNR 2525 M1207C

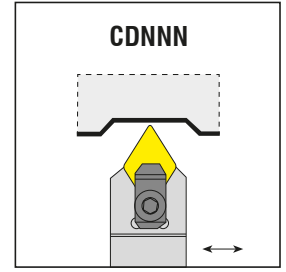
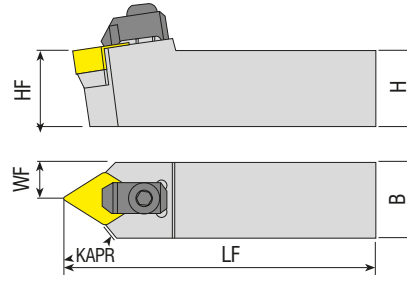

Takım Kodu
Ordering Code
Bestell-Bezeichnung

Stok Stock Lager	Takım Ölçüleri (mm) Dimension (mm) Abmessung (mm)					Kesici Uç Insert Wendeschneidplatte	Yedek Parçaları / Spare Parts / Ersatzteile					
	HF=H	B	LF	WF	Baskı Pabucu Wedge Clamp Spannpratze		Pabuç Vidası Clamp Screw Klemmschraube	Altlık Shim Unterlage	Altlık Vidası Shim Screw Schraube für Unterlage	Sekman Ring Feder	Anahtar Allen Key Innensechskantschlüssel	
CDNNN 2525 M1107C	●	25	25	150	12.5	DN.N 1107..	ACK-22	AKV-11-M8x29	AADN-2-0001	AAV-04-M5x12	ACS-01	AAL-05-4

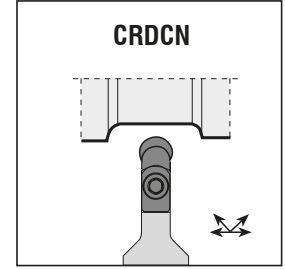
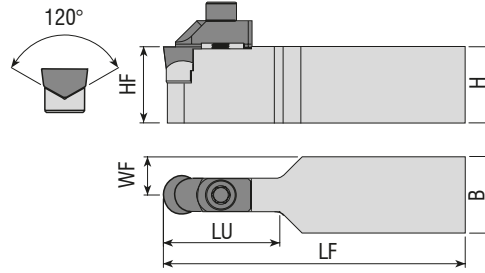

Takım Kodu
Ordering Code
Bestell-Bezeichnung

Stok Stock Lager	Takım Ölçüleri (mm) Dimension (mm) Abmessung (mm)						Kesici Uç Insert Wendeschneidplatte	Yedek Parçaları / Spare Parts / Ersatzteile				
	HF=H	B	LF	LU	WF	Baskı Pabucu Wedge Clamp Spannpratze		Pabuç Vidası Clamp Screw Klemmschraube	Altlık Shim Unterlage	Altlık Vidası Shim Screw Schraube für Unterlage	Anahtar Allen Key Innensechskantschlüssel	
CRDCN 2525 M06CV	●	25	25	150	19	12.5		ACK-27	2525-M3X14	AARC-3-0001	3007-M2.2X5	AAL-02-2.5
3225 P06CV	●	32	25	170	19	12.5	RCGX 060600					
4040 S06CV	●	40	40	250	19	20						
2525 M09CV	●	25	25	150	29	12.5						
3225 P09CV	●	32	25	170	29	12.5	RCGX 090700	ACK-28	2504-M5X16	AARC-3-0002	3008-M2.5x6	AAL-05-4
4040 S09CV	●	40	40	250	29	20						
2525 M12CV	●	25	25	150	38	12.5						
3225 P12CV	●	32	25	170	38	12.5	RCGX 120700	ACK-29	2505-M6X20	AARC-3-0003	3008-M2.5x6	AAL-07-5
4040 S12CV	●	40	40	250	38	20						

R: Sağ / Right / Rechts L: Sol/Left/Links

● Stokta / In Stock / Auf Lager ○ Stokta Yok / Non Stock Item / Kein Lagerartikel, Lieferzeit auf Anfrage

Sipariş Örneği/Ordering Example/Bestellbeispiel
1 ad./pcs./stück CDNNN 2525 M1107C

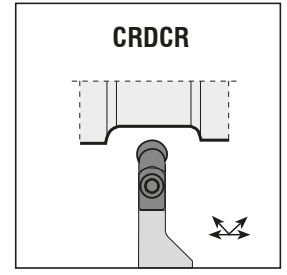
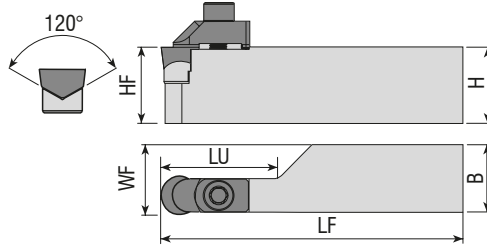

Takım Kodu Ordering Code Bestell-Bezeichnung	Stok Stock Lager		Takım Ölçüleri (mm) Dimension (mm) Abmessung (mm)				Kesici Uç Insert Wendeschneidplatte	Yedek Parçaları / Spare Parts / Ersatzteile					
	R	L	HF=H	B	LF	LU		WF	Baskı Pabucu Wedge Clamp Spannpratze	Pabuç Vidası Clamp Screw Klemmschraube	Altlık Shim Unterlage	Altlık Vidası Shim Screw Schraube für Unterlage	Anahtar Allen Key Innerschloßschlüssel
CRDCR/L 3225 P06CV	●	●	32	25	170	19.4	25.6	RCGX 060600	ACK-27	2525-M3X14	AARC-3-0001	3007-M2.2X5	AAL-02-2.5
3225 P09CV	●	●	32	25	170	29	25.8	RCGX 090700	ACK-28	2504-M5X16	AARC-3-0002	3008-M2.5x6	AAL-05-4
3225 P12CV	●	●	32	25	170	38.5	25.9	RCGX 120700	ACK-29	2505-M6X20	AARC-3-0003	3008-M2.5x6	AAL-07-5

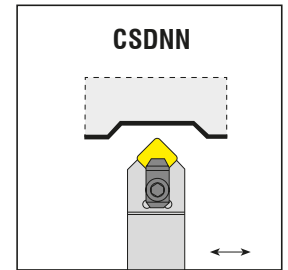
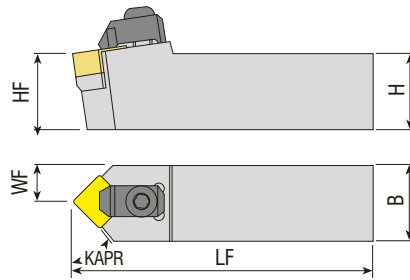

Takım Kodu Ordering Code Bestell-Bezeichnung	Stok Stock Lager		Takım Ölçüleri (mm) Dimension (mm) Abmessung (mm)				Kesici Uç Insert Wendeschneidplatte	Yedek Parçaları / Spare Parts / Ersatzteile					
			HF=H	B	LF	WF		Baskı Pabucu Wedge Clamp Spannpratze	Pabuç Vidası Clamp Screw Klemmschraube	Altlık Shim Unterlage	Altlık Vidası Shim Screw Schraube für Unterlage	Sekman Ring Feder	Anahtar Allen Key Innerschloßschlüssel
CSDNN 2525 M1207C	●		25	25	150	12.5	SN.N 1207..	ACK-13	AKV-11-M8x29	AASN-3-0004	AAV-02-M5x12	ACS-01	AAL-05-4
3232 P1207C	●		32	32	170	16							

R: Sağ / Right / Rechts L: Sol/Left/Links

● Stokta / In Stock / Auf Lager ○ Stokta Yok / Non Stock Item / Kein Lagerartikel, Lieferzeit auf Anfrage

Sipariş Örneği/Ordering Example/Bestellbeispiel
1 ad./pcs./stück CRDCR 3225 P06CV

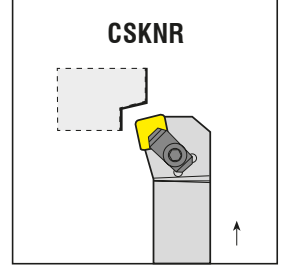
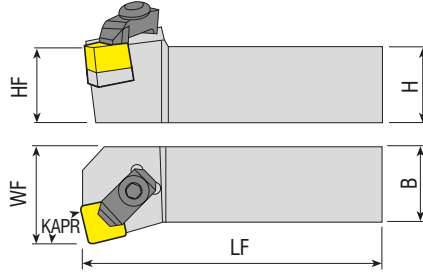

Takım Kodu Ordering Code Bestell-Bezeichnung	Stok Stock Lager		Takım Ölçüleri (mm) Dimension (mm) Abmessung (mm)				Kesici Uç Insert Wendeschneidplatte	Yedek Parçaları / Spare Parts / Ersatzteile					
	R	L	HF=H	B	LF	WF		Baskı Pabucu Wedge Clamp Spannpratze	Pabuç Vidası Clamp Screw Klemmschraube	Altlık Shim Unterlage	Altlık Vidası Shim Screw Schraube für Unterlage	Sekman Ring Feder	Anahtar Allen Key Inmenschenschlüssel
CSKNR/L 2525 M1207C	●	●	25	25	150	32	SN.N 1207..	ACK-13	AKV-11-M8x29	AASN-3-0004	AAV-02-M5x12	ACS-01	AAL-05-4
3232 P1207C	●	●	32	32	170	40							

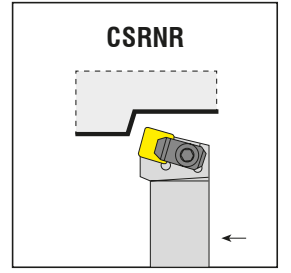
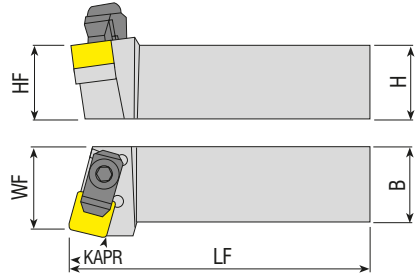

Takım Kodu Ordering Code Bestell-Bezeichnung	Stok Stock Lager		Takım Ölçüleri (mm) Dimension (mm) Abmessung (mm)				Kesici Uç Insert Wendeschneidplatte	Yedek Parçaları / Spare Parts / Ersatzteile					
	R	L	HF=H	B	LF	WF		Baskı Pabucu Wedge Clamp Spannpratze	Pabuç Vidası Clamp Screw Klemmschraube	Altlık Shim Unterlage	Altlık Vidası Shim Screw Schraube für Unterlage	Sekman Ring Feder	Anahtar Allen Key Inmenschenschlüssel
CSRNR/L 2525 M1207C	●	●	25	25	150	32	SN.N 1207..	ACK-13	AKV-11-M8x29	AASN-3-0004	AAV-02-M5x12	ACS-01	AAL-05-4
3232 P1207C	●	●	32	32	170	40							

R: Sağ / Right / Rechts L: Sol/Left/Links

● Stokta / In Stock / Auf Lager ○ Stokta Yok / Non Stock Item / Kein Lagerartikel, Lieferzeit auf Anfrage

Sipariş Örneği/Ordering Example/Bestellbeispiel

1 ad./pcs./stück CSKNR 2525 M1207C

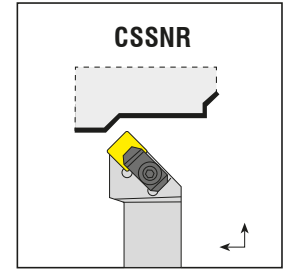
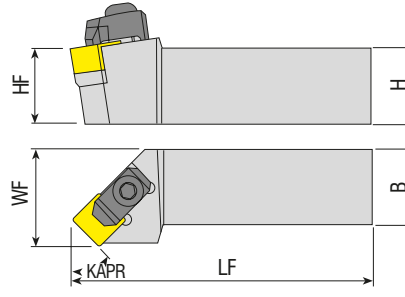

Takım Kodu Ordering Code Bestell-Bezeichnung	Stok Stock Lager		Takım Ölçüleri (mm) Dimension (mm) Abmessung (mm)				Kesici Uç Insert Wendeschnidplatte	Yedek Parçaları / Spare Parts / Ersatzteile					
	R	L	HF=H	B	LF	WF	Baskı Pabucu Wedge Clamp Spannpratze	Pabuç Vidası Clamp Screw Klemmschraube	Altlık Shim Unterlage	Altlık Vidası Shim Screw Schraube für Unterlage	Sekman Ring Feder	Anahtar Allen Key Innensechskantschlüssel	
CSSNR/L 2525 M1207C	●	●	25	25	150	32	SN.N 1207..	ACK-13	AKV-11-M8x29	AASN-3-0004	AAV-02-M5x12	ACS-01	AAL-05-4
3232 P1207C	●	●	32	32	170	40							

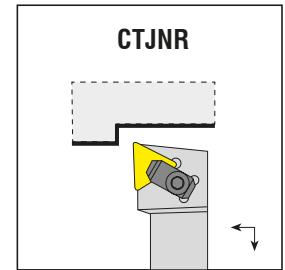
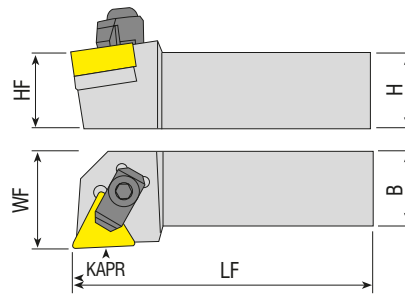

Takım Kodu Ordering Code Bestell-Bezeichnung	Stok Stock Lager		Takım Ölçüleri (mm) Dimension (mm) Abmessung (mm)				Kesici Uç Insert Wendeschnidplatte	Yedek Parçaları / Spare Parts / Ersatzteile					
	R	L	HF=H	B	LF	WF	Baskı Pabucu Wedge Clamp Spannpratze	Pabuç Vidası Clamp Screw Klemmschraube	Altlık Shim Unterlage	Altlık Vidası Shim Screw Schraube für Unterlage	Sekman Ring Feder	Anahtar Allen Key Innensechskantschlüssel	
CTJNR/L 2525 M1607C	●	●	25	25	150	32	TN.N 1607..	ACK-14	AKV-11-M8x29	AATN-2-0002	AAV-03-M5x12	ACS-01	AAL-05-4
3232 P1607C	○	○	32	32	170	40							

R: Sağ / Right / Rechts L: Sol/Left/Links

● Stokta / In Stock / Auf Lager ○ Stokta Yok / Non Stock Item / Kein Lagerartikel, Lieferzeit auf Anfrage

Sipariş Örneği/Ordering Example/Bestellbeispiel
1 ad./pcs./stück CSSNR 2525 M1207C



*konusulan
the spoken kalite...
quality...*

S-SİSTEM

S-SİSTEM DIŞ TORNA KATERLERİ
S-SYSTEM EXTERNAL TURNING TOOLHOLDERS
S-SYSTEM AUSSEN - DREHHALTER



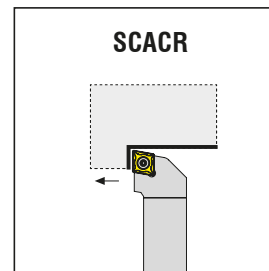
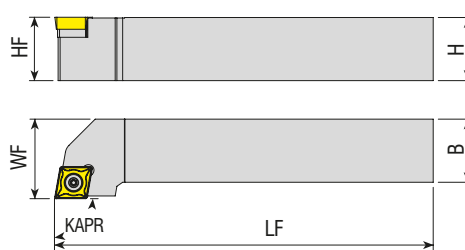

Takım Kodu Ordering Code Bestell-Bezeichnung	Stok Stock Lager		Takım Ölçüleri (mm) Dimension (mm) Abmessung (mm)				Kesici Uç Insert Wendeschneidplatte	Yedek Parçaları / Spare Parts / Ersatzteile				
	R	L	HF=H	B	LF	WF		Sıkma Vidası Screw Schraube	Altlık Shim Unterlage	Altlık Vidası Shim Screw Schraube für Unterlage	Tork Anahtar Torx Key Torx-Schlüssel	
SCACR/L 0808 E06	●	●	08	08	70	10	CCM. 0602..	4008-M2.5x6	-	-	80-T08	
1010 E06	●	●	10	10	70	12						
1212 F09	●	●	12	12	80	16						
1616 H09	●	●	16	16	100	20	CCM. 09T3..	4015-M3.5x11	AACN-2-0001	AAV-06-M3.5x11	80-T15	
2020 K09	●	●	20	20	125	25						
2020 K12	●	●	20	20	125	25	CCM. 1204..	1020-M4.5x16	AACN-2-0003	AAV-07-M4.5x13	80-T20	
2525 M12	●	●	25	25	150	32						

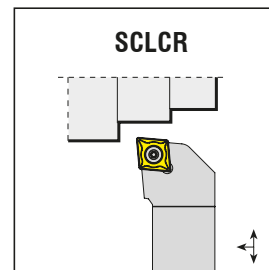
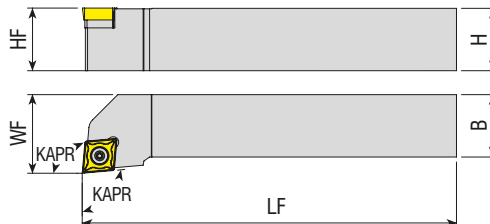
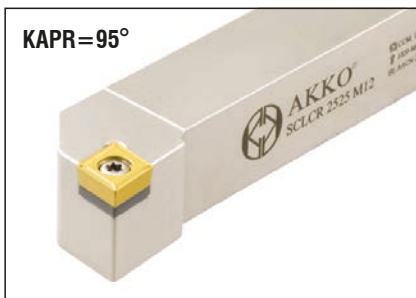

Takım Kodu Ordering Code Bestell-Bezeichnung	Stok Stock Lager		Takım Ölçüleri (mm) Dimension (mm) Abmessung (mm)				Kesici Uç Insert Wendeschneidplatte	Yedek Parçaları / Spare Parts / Ersatzteile				
	R	L	HF=H	B	LF	WF		Sıkma Vidası Screw Schraube	Altlık Shim Unterlage	Altlık Vidası Shim Screw Schraube für Unterlage	Tork Anahtar Torx Key Torx-Schlüssel	
SCLCR/L 0808 E06	●	●	08	08	70	10	CCM. 0602..	4008-M2.5x6	-	-	80-T08	
1010 E06	●	○	10	10	70	12						
1010 E09	●	●	10	10	70	12						
1212 F09	●	●	12	12	80	16	CCM. 09T3..	4015-M3.5x11	-	-	80-T15	
1616 H09	●	●	16	16	100	20						
2020 K09	●	●	20	20	125	25	CCM. 1204..	4015-M3.5x14	AACN-2-0001	AAV-06-M3.5x11	80-T20	
2525 M09	●	●	25	25	150	32						
1616 H12	●	○	16	16	100	20	CCM. 1204..	1020-M5x11	-	-	80-T20	
2020 K12	●	●	20	20	125	25						
2525 M12	●	●	25	25	150	32						

R: Sağ / Right / Rechts L: Sol/Left/Links

● Stokta / In Stock / Auf Lager ○ Stokta Yok / Non Stock Item / Kein Lagerartikel, Lieferzeit auf Anfrage

Sipariş Örneği/Ordering Example/Bestellbeispiel

1 ad./pcs./stück SCACR 0808 E06

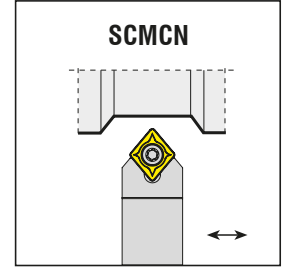
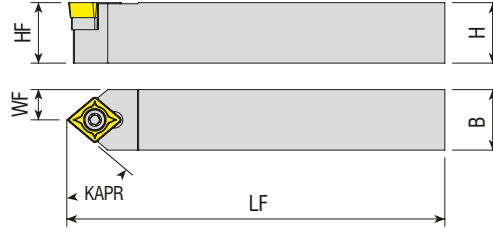
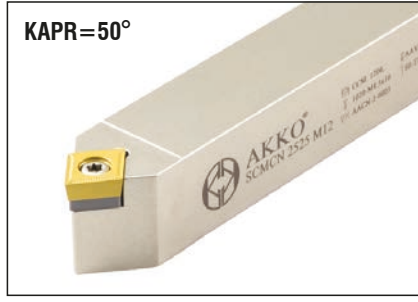

Takım Kodu Ordering Code Bestell-Bezeichnung	Stok Stock Lager		Takım Ölçüleri (mm) Dimension (mm) Abmessung (mm)				Kesici Uç Insert Wendeschneidplatte	Yedek Parçaları / Spare Parts / Ersatzteile			
	R	L	HF=H	B	LF	WF		Sıkma Vidası Screw Schraube	Altlık Shim Unterlage	Altlık Vidası Shim Screw Schraube für Unterlage	Tork Anahtar Torx Key Torx-Schlüssel
SCMCN 0808 E06	●		08	08	70	04	CCM. 0602..	4008-M2.5x6	-	-	80-T08
1010 E06	●		10	10	70	05					
1212 F06	●		12	12	80	06					
1212 F09	●		12	12	80	06	CCM. 09T3..	4015-M3.5x11	-	-	80-T15
1616 H09	●		16	16	100	08					
2020 K12	●		20	20	125	10	CCM. 1204..	1020-M4.5x16	AACN-2-0003	AAV-07-M4.5x13	80-T20
2525 M12	●		25	25	150	12.5					

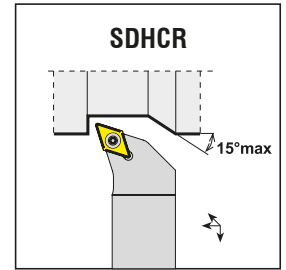
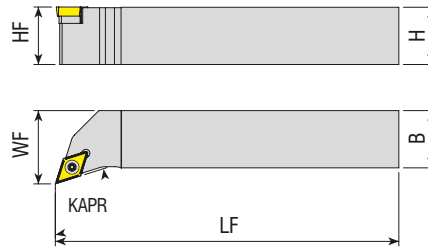
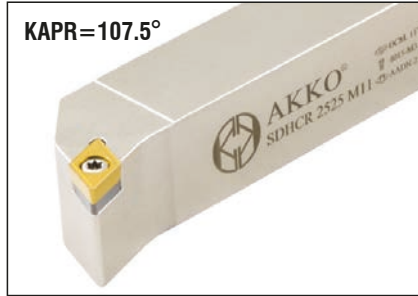

Takım Kodu Ordering Code Bestell-Bezeichnung	Stok Stock Lager		Takım Ölçüleri (mm) Dimension (mm) Abmessung (mm)				Kesici Uç Insert Wendeschneidplatte	Yedek Parçaları / Spare Parts / Ersatzteile			
	R	L	HF=H	B	LF	WF		Sıkma Vidası Screw Schraube	Altlık Shim Unterlage	Altlık Vidası Shim Screw Schraube für Unterlage	Tork Anahtar Torx Key Torx-Schlüssel
SDHCR/L 0808 E07	●	●	08	08	70	11	DCM. 0702..	4008-M2.5x6	-	-	80-T08
1010 E07	●	●	10	10	70	12					
1212 F07	●	●	12	12	80	16					
1616 H07	●	●	16	16	100	20					
1616 H11	●	●	16	16	100	20	DCM. 11T3..	4015-M3.5x14	AADN-2-0001	AAV-06-M3.5x11	80-T15
2020 K11	●	●	20	20	125	25					
2525 M11	●	●	25	25	150	32					
3232 P11	●	●	32	32	170	40					

R: Sağ / Right / Rechts L: Sol/Left/Links

● Stokta / In Stock / Auf Lager ○ Stokta Yok / Non Stock Item / Kein Lagerartikel, Lieferzeit auf Anfrage

Sipariş Örneği/Ordering Example/Bestellbeispiel

1 ad./pcs./stück SCMCN 0808 E06

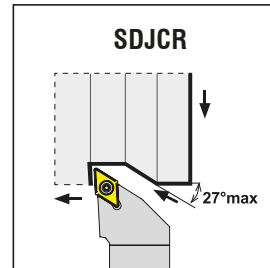
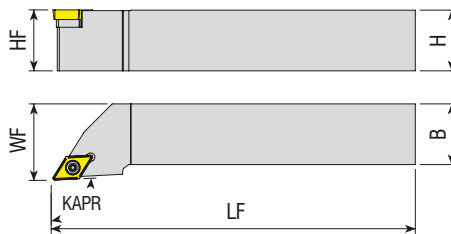
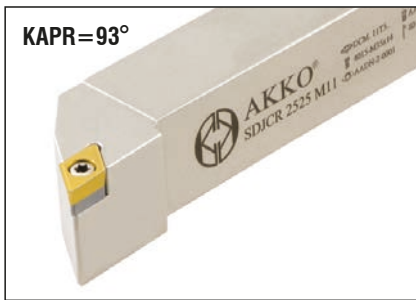

Takım Kodu Ordering Code Bestell-Bezeichnung	Stok Stock Lager		Takım Ölçüleri (mm) Dimension (mm) Abmessung (mm)				Kesici Uç Insert Wendeschneidplatte	Sıkma Vidası Screw Schraube	Altlık Shim Unterlage	Altlık Vidası Shim Screw Schraube für Unterlage	Tork Anahtar Torx Key Torx-Schlüssel
	R	L	HF=H	B	LF	WF					
SDJCR/L 0808 E07	●	●	08	08	70	10	DCM. 0702..	4008-M2.5x6	-	-	80-T08
1010 E07	●	●	10	10	70	12					
1212 F07	●	●	12	12	80	16					
1616 H07	●	●	16	16	100	20					
1616 H11	●	●	16	16	100	20	DCM. 11T3..	4015-M3.5x14	AADN-2-0001	AAV-06-M3.5x11	80-T15
2020 K11	●	●	20	20	125	25					
2525 M11	●	●	25	25	150	32					
3232 P11	●	●	32	32	170	40					

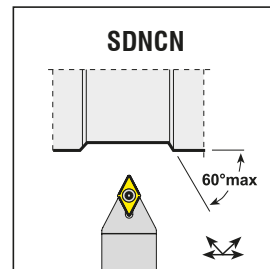
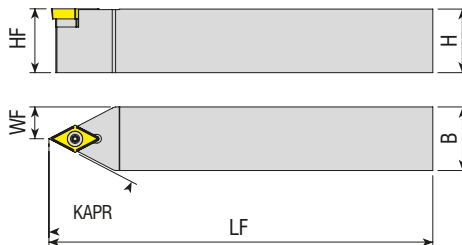

Takım Kodu Ordering Code Bestell-Bezeichnung	Stok Stock Lager		Takım Ölçüleri (mm) Dimension (mm) Abmessung (mm)				Kesici Uç Insert Wendeschneidplatte	Sıkma Vidası Screw Schraube	Altlık Shim Unterlage	Altlık Vidası Shim Screw Schraube für Unterlage	Tork Anahtar Torx Key Torx-Schlüssel
	R	L	HF=H	B	LF	WF					
SDNCR 0808 E07	●		08	08	70	4	DCM. 0702..	4008-M2.5x6	-	-	80-T08
1010 E07	●		10	10	70	5					
1212 F07	●		12	12	80	6					
1616 H07	●		16	16	100	8					
1616 H11	●		16	16	100	8	DCM. 11T3..	4015-M3.5x14	AADN-2-0001	AAV-06-M3.5x11	80-T15
2020 K11	●		20	20	125	10					
2525 M11	●		25	25	150	12.5					
3232 P11	●		32	32	170	16					

R: Sağ / Right / Rechts L: Sol/Left/Links

● Stokta / In Stock / Auf Lager ○ Stokta Yok / Non Stock Item / Kein Lagerartikel, Lieferzeit auf Anfrage

Sipariş Örneği/Ordering Example/Bestellbeispiel

1 ad./pcs./stück SDJCR 0808 E07

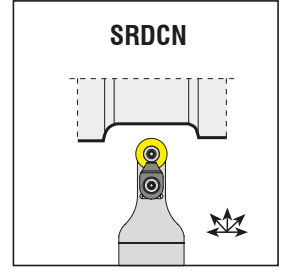
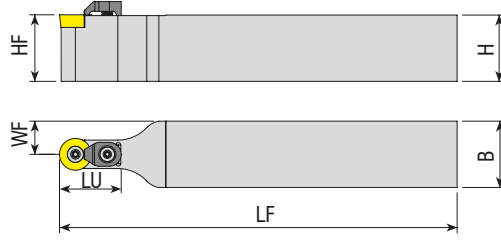

Takım Kodu
Ordering Code
Bestell-Bezeichnung

Stok
Stock
Lager

Takım Ölçüleri (mm)
Dimension (mm)
Abmessung (mm)

Kesici Uç
Insert
Wendeschneidplatte

Sıkma Vidası
Screw
Schraube

Yedek Parçaları / Spare Parts / Ersatzteile

Altlık
Shim
Unterlage

Altlık Vidası
Shim Screw
Schraube für Unterlage

Baskı Parçası
Wedge Clamp
Spannpratze

Baskı Vidası
Clamp Screw
Klemmschraube

Tork Anahtar
Torx Key
Torx-Schlüssel

Takım Kodu Ordering Code Bestell-Bezeichnung	Stok Stock Lager	Takım Ölçüleri (mm) Dimension (mm) Abmessung (mm)					Kesici Uç Insert Wendeschneidplatte	Sıkma Vidası Screw Schraube	Altlık Shim Unterlage	Altlık Vidası Shim Screw Schraube für Unterlage	Baskı Parçası Wedge Clamp Spannpratze	Baskı Vidası Clamp Screw Klemmschraube	Tork Anahtar Torx Key Torx-Schlüssel
		HF=H	B	LF	LU	WF							
SRDCN 1616 H06	●	16	16	100	15	8			-	-	-	-	80-T08
2020 K06	●	20	20	125	17	10							
2525 M06	●	25	25	150	17	12.5							
1616 H08C	●	16	16	100	15	8	RC.T 0803..	3008-M3x8	-	-	-	-	80-T08
2020 K08C	●	20	20	125	20	10							
2525 M08C	●	25	25	150	20	12.5							
1616 H10C	●	16	16	100	20	8	RC.T 10T3..	4015-M3.5x11	-	-	ACK-15	4015-M3.5x11	80-T15
2020 K10C	●	20	20	125	20	10							
2525 M10C	●	25	25	150	20	12.5							
3232 P10C	●	32	32	170	20	16	RC.T 1204..	4015-M3.5x11	-	-	-	-	80-T15
2020 K12C	●	20	20	125	22	10							
2525 M12C	●	25	25	150	22	12.5							
3232 P12C	●	32	32	170	22	16	RC.T 1605..	1020-M5x11	-	-	ACK-05	4015-M4x11	80-T20
2525 M16C	●	25	25	150	32	12.5							
3232 P16C	●	32	32	170	35	16							
2525 M20C	●	25	25	150	32	12.5	RC.T 2006..	1420-M6x16	-	-	ACK-09	AAV-05-M6x15	80-T20
3232 P20C	●	32	32	170	40	16							
3232 P25C	●	32	32	170	40	16							
3232 P32C	●	32	32	170	45	16	RC.T 2507..	1520-M6x16	-	-	ACK-09	AAV-05-M6x15	80-T20
							RC.T 3209..	1904-M8x1x20					AAL-05-4

R: Sağ / Right / Rechts L: Sol/Left/Links

● Stokta / In Stock / Auf Lager ○ Stokta Yok / Non Stock Item / Kein Lagerartikel, Lieferzeit auf Anfrage

Sipariş Örneği/Ordering Example/Bestellbeispiel

1 ad./pcs./stück SRDCN 1616 H06



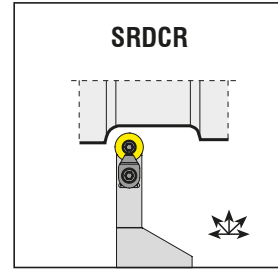
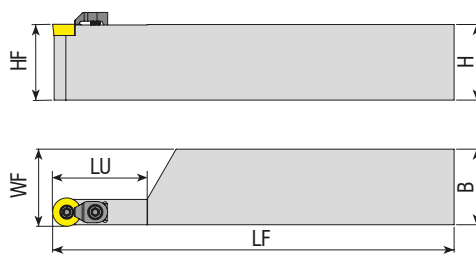

Takım Kodu
Ordering Code
Bestell-Bezeichnung

Stok Stock Lager	Takım Ölçüleri (mm) Dimension (mm) Abmessung (mm)						Kesici Uç Insert Wendeschneidplatte	Yedek Parçaları / Spare Parts / Ersatzteile						
	R	L	HF=H	B	LF	LU		WF	Sıkma Vidası Screw Schraube	Altlık Shim Unterlage	Altlık Vidası Shim Screw Schraube für Unterlage	Baskı Parçası Wedge Clamp Spannpratze	Baskı Vidası Clamp Screw Klemmschraube	Tork Anahtar Torx Key Torx-Schlüssel
SRDCR/L 3232 T06	●	●	32	32	300	20	32.35	RC.T 0602..	3008-M2.5x6	-	-	-	-	80-T08
3232 P12C	●	●	32	32	170	40	32.65	RC.T 1204..	4015-M3.5x11			ACK-05	4015-M4x11	80-T15

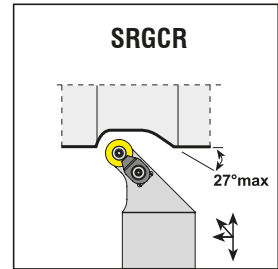
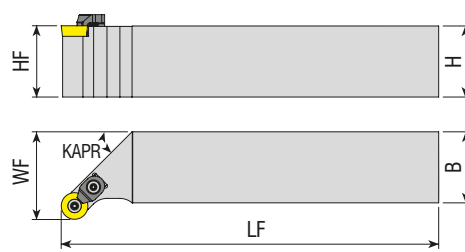

Takım Kodu
Ordering Code
Bestell-Bezeichnung

Stok Stock Lager	Takım Ölçüleri (mm) Dimension (mm) Abmessung (mm)						Kesici Uç Insert Wendeschneidplatte	Yedek Parçaları / Spare Parts / Ersatzteile						
	R	L	HF=H	B	LF	WF		Sıkma Vidası Screw Schraube	Altlık Shim Unterlage	Altlık Vidası Shim Screw Schraube für Unterlage	Baskı Parçası Wedge Clamp Spannpratze	Baskı Vidası Clamp Screw Klemmschraube	Tork Anahtar Torx Key Torx-Schlüssel	
SRGCR/L 1616 H06	●	●	16	16	100	20	RC.T 0602..	3008-M2.5x6	-	-	-	-	80-T08	
2020 K06	●	●	20	20	125	25								
1616 H08C	●	●	16	16	100	20	RC.T 0803..	3008-M3x8	-	-	ACK-15	4015-M3.5x11	80-T15	
2020 K08C	●	●	20	20	125	25								
2525 M08C	●	●	25	25	150	32								
1616 H10C	●	●	16	16	100	20	RC.T 10T3..	4015-M3.5x11	-	-	ACK-05	4015-M4x11	80-T15	
2020 K10C	●	●	20	20	125	25								
2525 M10C	●	●	25	25	150	32								
3232 P10C	●	●	32	32	170	40								
2020 K12C	●	●	20	20	125	25	RC.T 1204..	4015-M3.5x11	-	-	ACK-05	4015-M4x11	80-T15	
2525 M12C	●	●	25	25	150	32								
3232 P12C	●	●	32	32	170	40								

R: Sağ / Right / Rechts L: Sol/Left/Links

● Stokta / In Stock / Auf Lager ○ Stokta Yok / Non Stock Item / Kein Lagerartikel, Lieferzeit auf Anfrage

Sipariş Örneği/Ordering Example/Bestellbeispiel

1 ad./pcs./stück SRDCR 3232 T06

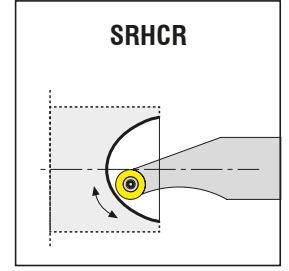
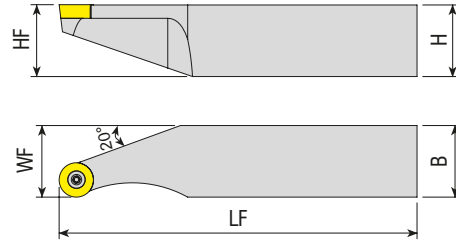

Takım Kodu Ordering Code Bestell-Bezeichnung	Stok Stock Lager		Takım Ölçüleri (mm) Dimension (mm) Abmessung (mm)					Kesici Uç Insert Wendeschneidplatte	Yedek Parçaları / Spare Parts / Ersatzteile			
	R	L	HF=H	B	LF	WF	MIN R		Sıkma Vidası Screw Schraube	Altlık Shim Unterlage	Altlık Vidası Shim Screw Schraube für Unterlage	Tork Anahtar Torx Key Torx-Schlüssel
SRHCR/L 2525 K06	●	○	25	25	125	25	32.5					
2525 K08	●	●	25	25	125	25	32.5	RCM. 0602..	3008-M2.5x6	-	-	80-T08
2525 K10	●	●	25	25	125	25	36	RCM. 0803..	3008-M3x8	-	-	80-T15
2525 K12	●	●	25	25	125	25	40	RCM. 10T3..	4015-M3.5x11	-	-	80-T15
2525 K16	●	●	25	25	125	25	47.5	RCM. 1204..	1020-M5x11	-	-	80-T20
								RCM. 1606..	1020-M5x11	-	-	80-T20

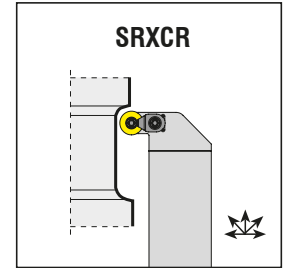
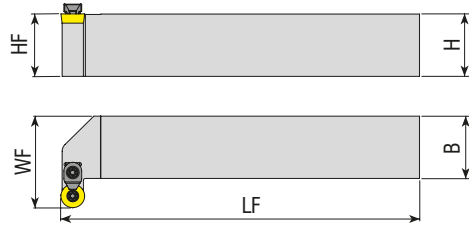

Takım Kodu Ordering Code Bestell-Bezeichnung	Stok Stock Lager		Takım Ölçüleri (mm) Dimension (mm) Abmessung (mm)				Kesici Uç Insert Wendeschneidplatte	Sıkma Vidası Screw Schraube	Altlık Shim Unterlage	Altlık Vidası Shim Screw Schraube für Unterlage	Baskı Parçası Wedge Clamp Spannpratze	Baskı Vidası Clamp Screw Klemmschraube	Tork Anahtar Torx Key Torx-Schlüssel
	R	L	HF=H	B	LF	WF							
SRXCR/L 3232 X08C	●	●	32	32	220	47							
3232 X10C	●	●	32	32	220	47	RC.T 0803..	3008-M3x8	-	-	ACK-15	4015-M3.5x11	80-T08
3232 X12C	●	●	32	32	220	47	RC.T 10T3..	4015-M3.5x11	-	-	ACK-05	4015-M4x11	80-T15
							RC.T 1204..						

R: Sağ / Right / Rechts L: Sol/Left/Links
● Stokta / In Stock / Auf Lager ○ Stokta Yok / Non Stock Item / Kein Lagerartikel, Lieferzeit auf Anfrage

Sipariş Örneği/Ordering Example/Bestellbeispiel
1 ad./pcs./stück SRHCR 2525 K16

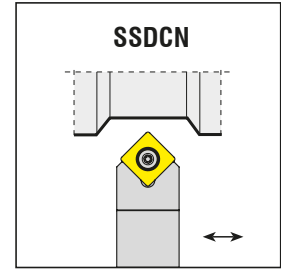
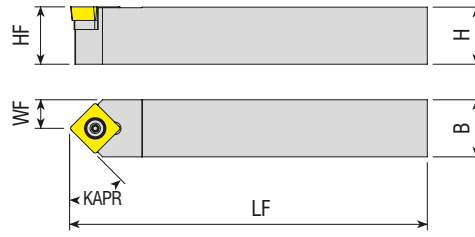

Takım Kodu Ordering Code Bestell-Bezeichnung	Stok Stock Lager	Takım Ölçüleri (mm) Dimension (mm) Abmessung (mm)				Kesici Uç Insert Wendeschneidplatte	Yedek Parçaları / Spare Parts / Ersatzteile			
		HF=H	B	LF	WF		Sıkma Vidası Screw Schraube	Altlık Shim Unterlage	Altlık Vidası Shim Screw Schraube für Unterlage	Tork Anahtar Torx Key Torx-Schlüssel
SSDCN 1212 F09	●	12	12	80	6	SC.T 09T3..	4015-M3.5x11	-	-	80-T15
1616 H09	●	16	16	100	8		4015-M3.5x14	AASN-2-0001	AAV-06-M3.5x11	
2020 K09	●	20	20	125	10		4020-M4.5x12	-	AAV-10-M4.5x8	
1616 H12	●	16	16	100	8	SC.T 1204..	1020-M4.5x16	AASN-2-0004	AAV-07-M4.5x13	80-T20
2020 K12	●	20	20	125	10		-	-	-	
2525 M12	●	25	25	150	12.5		-	-	-	

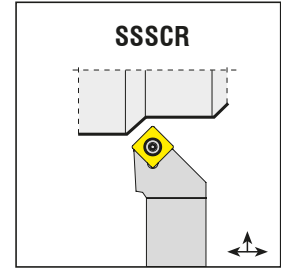
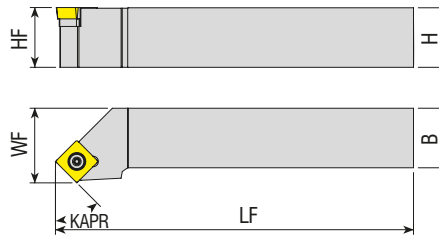

Takım Kodu Ordering Code Bestell-Bezeichnung	Stok Stock Lager		Takım Ölçüleri (mm) Dimension (mm) Abmessung (mm)				Kesici Uç Insert Wendeschneidplatte	Yedek Parçaları / Spare Parts / Ersatzteile			
	R	L	HF=H	B	LF	WF		Sıkma Vidası Screw Schraube	Altlık Shim Unterlage	Altlık Vidası Shim Screw Schraube für Unterlage	Tork Anahtar Torx Key Torx-Schlüssel
SSSCR/L 1212 F09	●	●	12	12	80	16	SC.T 09T3..	4015-M3.5x11	-	-	80-T15
1616 H09	●	●	16	16	100	20		4015-M3.5x14	AASN-2-0001	AAV-06-M3.5x11	
2020 K09	●	●	20	20	125	25		4020-M4.5x12	-	AAV-10-M4.5x8	
1616 H12	●	●	16	16	100	20	SC.T 1204..	1020-M4.5x16	AASN-2-0004	AAV-07-M4.5x13	80-T20
2020 K12	●	●	20	20	125	25		-	-	-	
2525 M12	●	●	25	25	150	32		-	-	-	

R: Sağ / Right / Rechts L: Sol/Left/Links

● Stokta / In Stock / Auf Lager ○ Stokta Yok / Non Stock Item / Kein Lagerartikel, Lieferzeit auf Anfrage

Sipariş Örneği/Ordering Example/Bestellbeispiel

1 ad./pcs./stück SSDCN 1212 F09

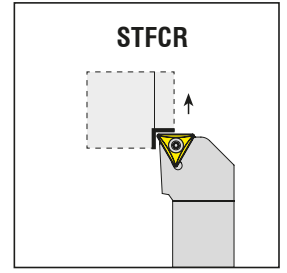
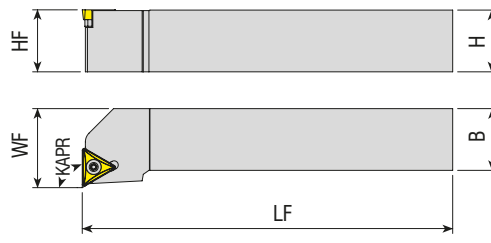

Takım Kodu Ordering Code Bestell-Bezeichnung	Stok Stock Lager		Takım Ölçüleri (mm) Dimension (mm) Abmessung (mm)				Kesici Uç Insert Wendeschneidplatte	Yedek Parçaları / Spare Parts / Ersatzteile			
	R	L	HF=H	B	LF	WF		Sıkma Vidası Screw Schraube	Altlık Shim Unterlage	Altlık Vidası Shim Screw Schraube für Unterlage	Tork Anahtar Torx Key Torx-Schlüssel
STFGR/L 0808 E09	○	○	08	08	70	10	TC.T 0902..	3007-M2.2x5	-	-	80-T07
1010 E09	●	●	10	10	70	12					
1212 F11	●	●	12	12	80	16					
1616 H11	●	●	16	16	100	20	TC.T 1102..	4008-M2.5x6	-	-	80-T08
1616 H16	●	●	16	16	100	20					
2020 K16	●	●	20	20	125	25					
2525 M16	●	●	25	25	150	32	TC.T 16T3..	4015-M3.5x14	AATN-2-0001	AAV-06-M3.5x11	80-T15
3232 P16	●	●	32	32	170	40					

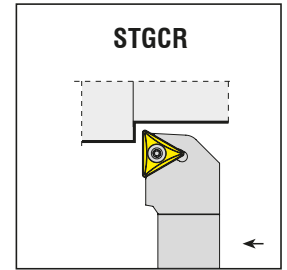
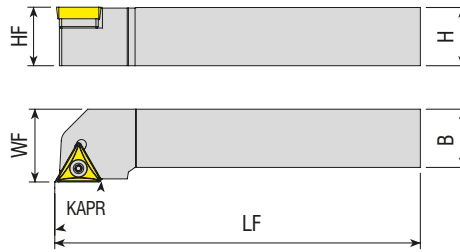

Takım Kodu Ordering Code Bestell-Bezeichnung	Stok Stock Lager		Takım Ölçüleri (mm) Dimension (mm) Abmessung (mm)				Kesici Uç Insert Wendeschneidplatte	Yedek Parçaları / Spare Parts / Ersatzteile			
	R	L	HF=H	B	LF	WF		Sıkma Vidası Screw Schraube	Altlık Shim Unterlage	Altlık Vidası Shim Screw Schraube für Unterlage	Tork Anahtar Torx Key Torx-Schlüssel
STGCR/L 0808 E09	●	●	08	08	70	10	TC.T 0902..	3007-M2.2x5	-	-	80-T07
1010 E09	●	●	10	10	70	12					
1212 F11	●	●	12	12	80	16					
1616 H11	●	●	16	16	100	20	TC.T 1102..	4008-M2.5x6	-	-	80-T08
1616 H16	●	●	16	16	100	20					
2020 K16	●	●	20	20	125	25					
2525 M16	●	●	25	25	150	32	TC.T 16T3..	4015-M3.5x14	AATN-2-0001	AAV-06-M3.5x11	80-T15
3232 P16	●	●	32	32	170	40					

R: Sağ / Right / Rechts L: Sol/Left/Links

● Stokta / In Stock / Auf Lager ○ Stokta Yok / Non Stock Item / Kein Lagerartikel, Lieferzeit auf Anfrage

Sipariş Örneği/Ordering Example/Bestellbeispiel

1 ad./pcs./stück STFGR 0808 E09

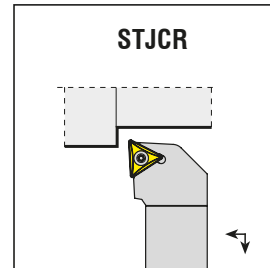
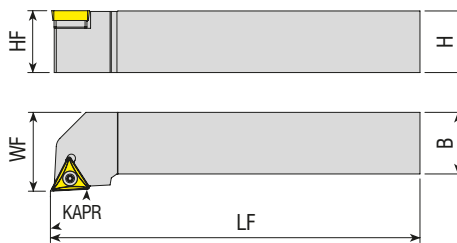

Takım Kodu Ordering Code Bestell-Bezeichnung	Stok Stock Lager		Takım Ölçüleri (mm) Dimension (mm) Abmessung (mm)				Kesici Uç Insert Wendeschneidplatte	Yedek Parçaları / Spare Parts / Ersatzteile			
	R	L	HF=H	B	LF	WF		Sıkma Vidası Screw Schraube	Altlık Shim Unterlage	Altlık Vidası Shim Screw Schraube für Unterlage	Tork Anahtar Torx Key Torx-Schlüssel
STJCR/L 0808 E09	●	●	08	08	70	10	TC.T 0902..	3007-M2.2x5			80-T07
1010 E09	●	●	10	10	70	12					
1212 F11	●	●	12	12	80	16					
1616 H11	●	●	16	16	100	20	TC.T 1102..	4008-M2.5x6			80-T08
1616 H16	●	●	16	16	100	20					
2020 K16	●	●	20	20	125	25	TC.T 16T3..	4015-M3.5x14	AATN-2-0001	AAV-06-M3.5x11	80-T15
2525 M16	●	●	25	25	150	32					
3232 P16	●	●	32	32	170	40					

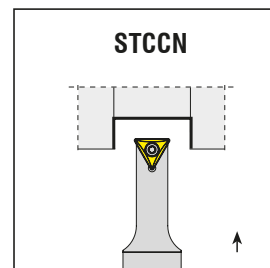
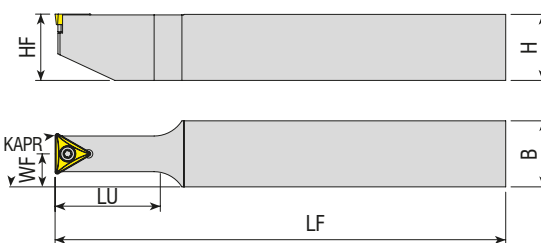

Takım Kodu Ordering Code Bestell-Bezeichnung	Stok Stock Lager		Takım Ölçüleri (mm) Dimension (mm) Abmessung (mm)					Kesici Uç Insert Wendeschneidplatte	Yedek Parçaları / Spare Parts / Ersatzteile			
	R	L	HF=H	B	LF	WF	LU		Sıkma Vidası Screw Schraube	Altlık Shim Unterlage	Altlık Vidası Shim Screw Schraube für Unterlage	Tork Anahtar Torx Key Torx-Schlüssel
STCCN 2020 L11	●		20	20	140	10	50	TC.T 1102..	4008-M2.5x6			80-T08
1616 K16	●		16	16	125	8	24					
2020 M16	●		20	20	150	10	30	TC.T 16T3..	4015-M3.5x14	AATN-2-0001	AAV-06-M3.5x11	80-T15
2525 P16	●		25	25	170	12.5	37.5					
3232 R16	●		32	32	200	16	48					
2525 P22	●		25	25	170	12.5	80	TC.T 2204..	4020-M4.5x12			80-T20

R: Sağ / Right / Rechts L: Sol/Left/Links

● Stokta / In Stock / Auf Lager ○ Stokta Yok / Non Stock Item / Kein Lagerartikel, Lieferzeit auf Anfrage

Sipariş Örneği/Ordering Example/Bestellbeispiel

1 ad./pcs./stück STJCR 0808 E09

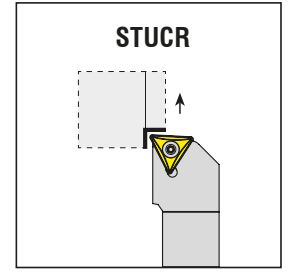
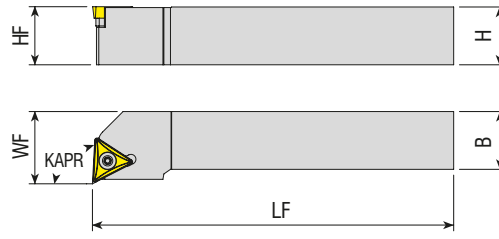

Takım Kodu Ordering Code Bestell-Bezeichnung	Stok Stock Lager		Takım Ölçüleri (mm) Dimension (mm) Abmessung (mm)				Kesici Uç Insert Wendeschneidplatte	Sıkma Vidası Screw Schraube	Altlık Shim Unterlage	Altlık Vidası Shim Screw Schraube für Unterlage	Tork Anahtar Torx Key Torx-Schlüssel
	R	L	HF=H	B	LF	WF					
STUCR/L 0808 E09	●	●	08	08	70	10	TC.T 0902..	3007-M2.2x5			80-T07
1010 E09	●	●	10	10	70	12					
1212 F11	●	●	12	12	80	16					
1616 H11	●	●	16	16	100	20	TC.T 1102..	4008-M2.5x6			80-T08
1616 H16	○	○	16	16	100	20					
2020 K16	●	●	20	20	125	25	TC.T 16T3..	4015-M3.5x14	AATN-2-0001	AAV-06-M3.5x11	80-T15
2525 M16	●	●	25	25	150	32					
3232 P16	●	●	32	32	170	40					

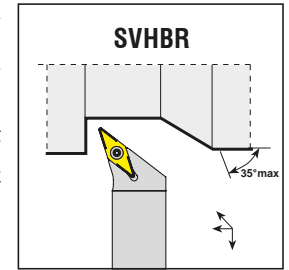
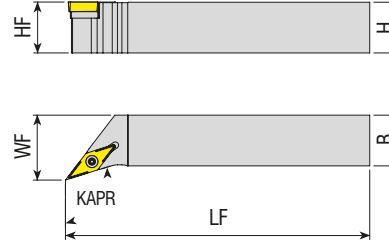
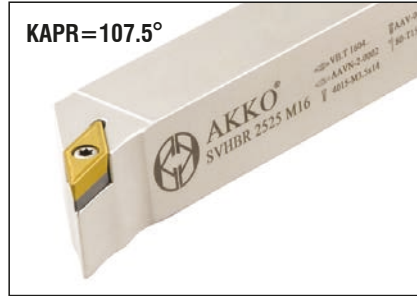

Takım Kodu Ordering Code Bestell-Bezeichnung	Stok Stock Lager		Takım Ölçüleri (mm) Dimension (mm) Abmessung (mm)				Kesici Uç Insert Wendeschneidplatte	Sıkma Vidası Screw Schraube	Altlık Shim Unterlage	Altlık Vidası Shim Screw Schraube für Unterlage	Tork Anahtar Torx Key Torx-Schlüssel
	R	L	HF=H	B	LF	WF					
SVHBR/L 1212 F11	●	●	12	12	80	16	VBM. 1103..	4008-M2.5x6			80-T08
1616 H11	●	●	16	16	100	20					
2020 K11	●	●	20	20	125	25					
2020 K16	●	●	20	20	125	25	VBM. 1604..	4015-M3.5x14	AAVN-2-0002	AAV-06-M3.5x11	80-T15
2525 M16	●	●	25	25	150	32					
3232 P16	●	●	32	32	170	40					

R: Sağ / Right / Rechts L: Sol/Left/Links
● Stokta / In Stock / Auf Lager ○ Stokta Yok / Non Stock Item / Kein Lagerartikel, Lieferzeit auf Anfrage

Sipariş Örneği/Ordering Example/Bestellbeispiel
1 ad./pcs./stück STUCR 0808 E09

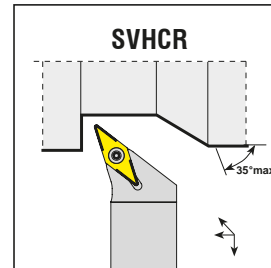
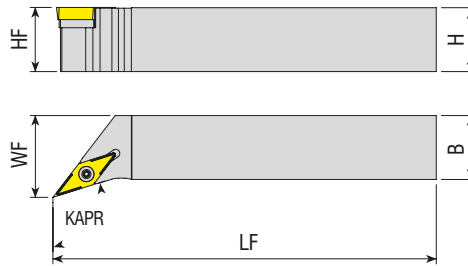

Takım Kodu
Ordering Code
Bestell-Bezeichnung

Stok
Stock
Lager

Takım Ölçüleri (mm)
Dimension (mm)
Abmessung (mm)

Kesici Uç
Insert
Wendeschneidplatte

Sıkma Vidası
Screw
Schraube

Altlık
Shim
Unterlage

Altlık Vidası
Shim Screw
Schraube für Unterlage

Tork Anahtar
Torx Key
Torx-Schlüssel

Yedek Parçaları / Spare Parts / Ersatzteile

R	L	HF=H	B	LF	WF
---	---	------	---	----	----

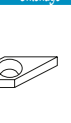
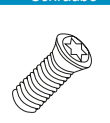

SVHCR/L 1212 F11	●	●	12	12	80	16	VC.T 1103..	4008-M2.5x6	-	-	80-T08
1616 H11	●	●	16	16	100	20					
2020 K11	●	●	20	20	125	25					
2020 K16	●	●	20	20	125	25	VC.T 1604..	4015-M3.5x14	AAVN-2-0002	AAV-06-M3.5x11	80-T15
2525 M16	●	●	25	25	150	32					
3232 P16	●	●	32	32	170	40					

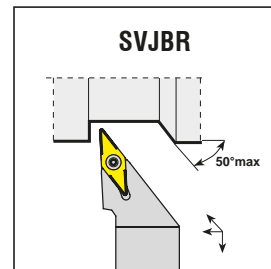
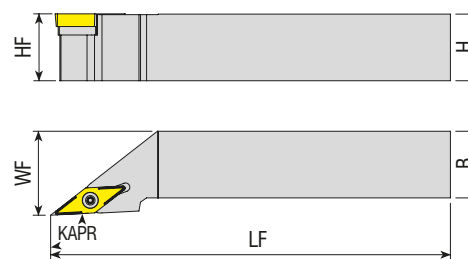

Takım Kodu
Ordering Code
Bestell-Bezeichnung

Stok
Stock
Lager

Takım Ölçüleri (mm)
Dimension (mm)
Abmessung (mm)

Kesici Uç
Insert
Wendeschneidplatte

Sıkma Vidası
Screw
Schraube

Altlık
Shim
Unterlage

Altlık Vidası
Shim Screw
Schraube für Unterlage

Tork Anahtar
Torx Key
Torx-Schlüssel

Yedek Parçaları / Spare Parts / Ersatzteile

R	L	HF=H	B	LF	WF
---	---	------	---	----	----

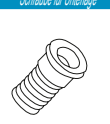
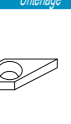

SVJBR/L 1212 F11	●	●	12	12	80	16	VBM. 1103..	4008-M2.5x6	-	-	80-T08
1616 H11	●	●	16	16	100	20					
2020 K11	●	●	20	20	125	25					
1616 H16	●	●	16	16	100	20	VBM. 1604..	4015-M3.5x14	AAVN-2-0002	AAV-06-M3.5x11	80-T15
2020 K16	●	●	20	20	125	25					
2525 M16	●	●	25	25	150	32					
3232 P16	●	●	32	32	170	40					

R: Sağ / Right / Rechts L: Sol/Left/Links

● Stokta / In Stock / Auf Lager ○ Stokta Yok / Non Stock Item / Kein Lagerartikel, Lieferzeit auf Anfrage

Sipariş Örneği/Ordering Example/Bestellbeispiel

1 ad./pcs./stück SVHCR 1212 F11

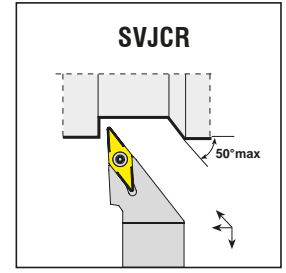
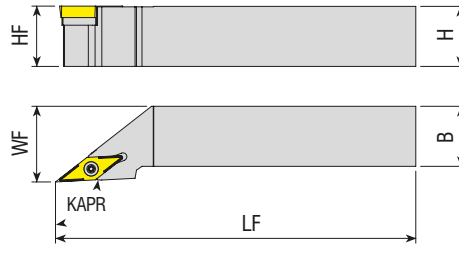

Takım Kodu Ordering Code Bestell-Bezeichnung	Stok Stock Lager		Takım Ölçüleri (mm) Dimension (mm) Abmessung (mm)				Kesici Uç Insert Wendeschneidplatte	Sıkma Vidası Screw Schraube	Altlık Shim Unterlage	Altlık Vidası Shim Screw Schraube für Unterlage	Tork Anahtar Torx Key Torx-Schlüssel
	R	L	HF=H	B	LF	WF					
SVJCR/L 1212 F11	●	●	12	12	80	16	VC.T 1103..	4008-M2.5x6			80-T08
1616 H11	●	●	16	16	100	20					
2020 K11	●	●	20	20	125	25					
2525 M11	●	●	25	25	150	32	VC.T 1604..	4015-M3.5x11	AAVN-2-0002	AAV-06-M3.5x11	80-T15
1212 F16	●	●	12	12	80	16					
2020 K16	●	●	20	20	125	25					
2525 M16	●	●	25	25	150	32					
3232 P16	●	●	32	32	170	40					

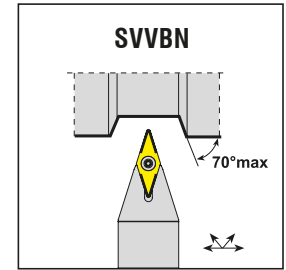
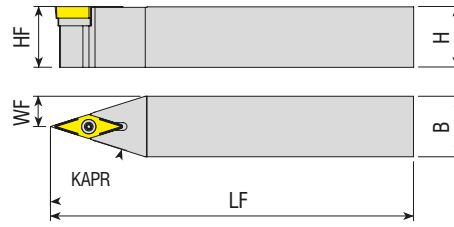

Takım Kodu Ordering Code Bestell-Bezeichnung	Stok Stock Lager		Takım Ölçüleri (mm) Dimension (mm) Abmessung (mm)				Kesici Uç Insert Wendeschneidplatte	Sıkma Vidası Screw Schraube	Altlık Shim Unterlage	Altlık Vidası Shim Screw Schraube für Unterlage	Tork Anahtar Torx Key Torx-Schlüssel
	R	L	HF=H	B	LF	WF					
SVVBN 1212 F11	●		12	12	80	06	VBM. 1103..	4008-M2.5x6			80-T08
1616 H11	●		16	16	100	08					
2020 K11	●		20	20	125	10					
2020 K16	●		20	20	125	10	VBM. 1604..	4015-M3.5x14	AAVN-2-0002	AAV-06-M3.5x11	80-T15
2525 M16	●		25	25	150	12.5					
3232 P16	●		32	32	170	16					

R: Sağ / Right / Rechts L: Sol/Left/Links

● Stokta / In Stock / Auf Lager ○ Stokta Yok / Non Stock Item / Kein Lagerartikel, Lieferzeit auf Anfrage

Sipariş Örneği/Ordering Example/Bestellbeispiel

1 ad./pcs./stück SVJCR 1212 F11

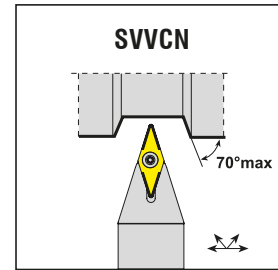
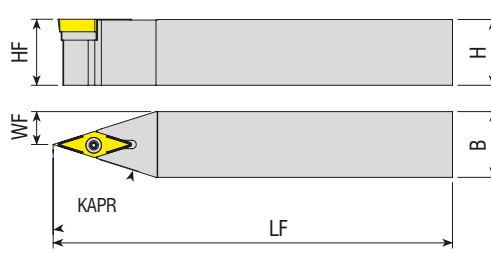

Takım Kodu
Ordering Code
Bestell-Bezeichnung

Stok
Stock
Lager

Takım Ölçüleri (mm)
Dimension (mm)
Abmessung (mm)

Kesici Uç
Insert
Wendeschneidplatte

Sıkma Vidası
Screw
Schraube

Altık
Shim
Unterlage

Altık Vidası
Shim Screw
Schraube für Unterlage

Tork Anahtar
Torx Key
Torx-Schlüssel

Yedek Parçaları / Spare Parts / Ersatzteile

Takım Kodu Ordering Code Bestell-Bezeichnung	Stok Stock Lager		Takım Ölçüleri (mm) Dimension (mm) Abmessung (mm)				Kesici Uç Insert Wendeschneidplatte	Sıkma Vidası Screw Schraube	Altık Shim Unterlage	Altık Vidası Shim Screw Schraube für Unterlage	Tork Anahtar Torx Key Torx-Schlüssel
	HF=H	B	LF	WF							
SVVCN 1212 F11	●		12	12	80	06	VC.T 1103..	4008-M2.5x6	-	-	80-T08
1616 H11	●		16	16	100	08					
2020 K11	●		20	20	125	10					
2020 K16	●		20	20	125	10	VC.T 1604..	4015-M3.5x14	AAVN-2-0002	AAV-06-M3.5x11	80-T15
2525 M16	●		25	25	150	12.5					
3232 P16	●		32	32	170	16					

S-SİSTEM İSVİÇRE TİPİ KAYAR OTOMAT MAKİNA TAKIMLARI
S-SYSTEM TOOLS FOR SWISS TYPE SLIDING AUTOMATIC LATHES
S-SYSTEM FÜR LANGDREHAUTOMATEN

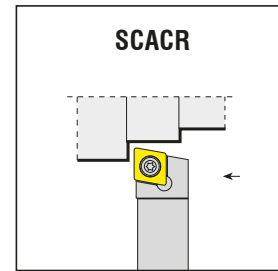
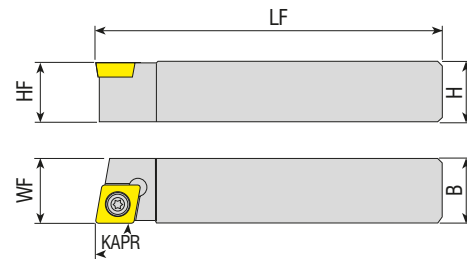
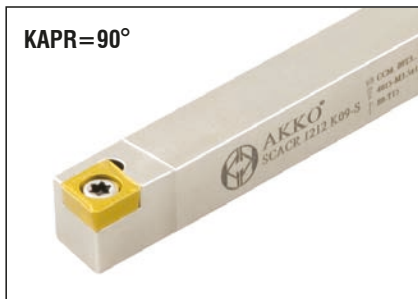

Takım Kodu
Ordering Code
Bestell-Bezeichnung

Stok
Stock
Lager

Takım Ölçüleri (mm)
Dimension (mm)
Abmessung (mm)

Kesici Uç
Insert
Wendeschneidplatte

Sıkma Vidası
Screw
Schraube

Altık
Shim
Unterlage

Altık Vidası
Shim Screw
Schraube für Unterlage

Tork Anahtar
Torx Key
Torx-Schlüssel

Yedek Parçaları / Spare Parts / Ersatzteile

Takım Kodu Ordering Code Bestell-Bezeichnung	Stok Stock Lager		Takım Ölçüleri (mm) Dimension (mm) Abmessung (mm)				Kesici Uç Insert Wendeschneidplatte	Sıkma Vidası Screw Schraube	Altık Shim Unterlage	Altık Vidası Shim Screw Schraube für Unterlage	Tork Anahtar Torx Key Torx-Schlüssel
	R	L	HF=H	B	LF	WF					
SCACR/L 0808 X06-S	●	●	08	08	115	08	CCM. 0602..	4008-M2.5x6	-	-	80-T08
1010 K06-S	●	○	10	10	125	10					
1212 G06-S	●	○	12	12	90	12					
1212 K06-S	●	○	12	12	125	12					
1616 F06-S	○	○	16	16	75	16					
1616 K06-S	○	○	16	16	125	16					
1212 G09-S	○	○	12	12	90	12	CCM. 09T3..	4015-M3.5x11	-	-	80-T15
1212 K09-S	●	●	12	12	125	12					
1616 F09-S	○	○	16	16	75	16					
1616 K09-S	●	●	16	16	125	16					
2020 K09-S	●	●	20	20	125	20					









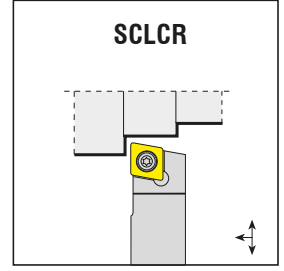
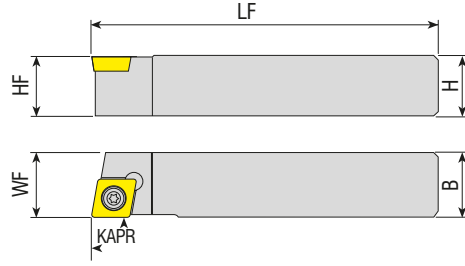
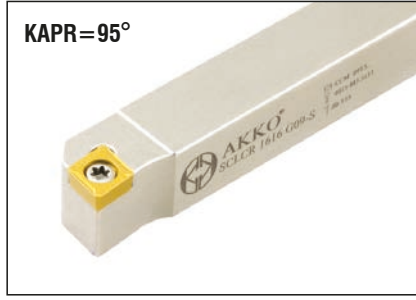

R: Sağ / Right / Rechts L: Sol/Left/Links

● Stokta / In Stock / Auf Lager ○ Stokta Yok / Non Stock Item / Kein Lagerartikel, Lieferzeit auf Anfrage

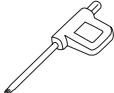





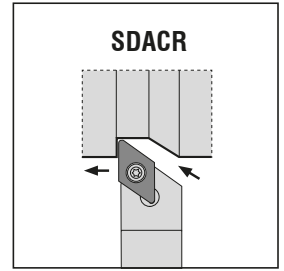
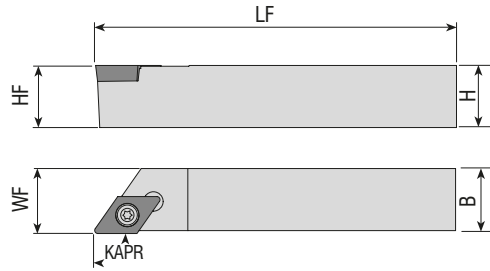

Sipariş Örneği/Ordering Example/Bestellbeispiel

1 ad./pcs./stück SVVCN 1212 F11



Takım Kodu Ordering Code Bestell-Bezeichnung	Stok Stock Lager						Kesici Uç Insert Wendeschneidplatte	Yedek Parçaları / Spare Parts / Ersatzteile				
	Takım Ölçüleri (mm) Dimension (mm) Abmessung (mm)							Sıkma Vidası Screw Schraube	Altlık Shim Unterlage	Altlık Vidası Shim Screw Schraube für Unterlage	Tork Anahtar Torx Key Torx-Schlüssel	
	R	L	HF=H	B	LF	WF						
SCLCR/L 0808 X06-S	●	●	08	08	115	08						
1010 X06-S	●	○	10	10	115	10						
1212 G06-S	○	○	12	12	90	12						
1212 X06-S	●	○	12	12	130	12						
1212 K06-S	○	●	12	12	125	12						
1616 F06-S	●	○	16	16	75	16						
1616 X06-S	●	○	16	16	130	16						
1212 G09-S	●	●	12	12	90	12						
1212 X09-S	●	○	12	12	130	12						
1616 F09-S	●	○	16	16	75	16						
1616 G09-S	●	○	16	16	90	16						
1616 X09-S	●	○	16	16	115	16						
2020 X09-S	●	○	20	20	120	20						
SCLCR/L 0808 X09-S	●	○	08	08	115	08						
1010 X09-S	●	○	10	10	115	10						
1212 G09-S	○	○	12	12	90	12						
1212 X09-S	●	○	12	12	130	12						
1616 F09-S	●	○	16	16	75	16						
1616 X09-S	●	○	16	16	130	16						
1212 G11-S	○	○	12	12	90	12						
1212 K11-S	●	●	12	12	125	12						
1616 F11-S	●	○	16	16	75	16						
1616 K11-S	●	●	16	16	125	16						
2020 K11-S	●	●	20	20	125	20						

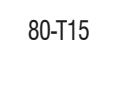

Takım Kodu Ordering Code Bestell-Bezeichnung	Stok Stock Lager						Kesici Uç Insert Wendeschneidplatte	Yedek Parçaları / Spare Parts / Ersatzteile				
	Takım Ölçüleri (mm) Dimension (mm) Abmessung (mm)							Sıkma Vidası Screw Schraube	Altlık Shim Unterlage	Altlık Vidası Shim Screw Schraube für Unterlage	Tork Anahtar Torx Key Torx-Schlüssel	
	R	L	HF=H	B	LF	WF						
SDACR/L 0808 X07-S	●	●	08	08	115	08						
1010 K07-S	●	●	10	10	125	10						
1212 G07-S	○	○	12	12	90	12						
1212 K07-S	●	●	12	12	125	12						
1616 F07-S	●	○	16	16	75	16						
1616 K07-S	●	●	16	16	125	16						
1212 G11-S	○	○	12	12	90	12						
1212 K11-S	●	●	12	12	125	12						
1616 F11-S	●	○	16	16	75	16						
1616 K11-S	●	●	16	16	125	16						
2020 K11-S	●	●	20	20	125	20						
SDACR/L 0808 X11-S	●	○	08	08	115	08						
1010 K11-S	●	○	10	10	115	10						
1212 G11-S	○	○	12	12	90	12						
1212 K11-S	●	○	12	12	125	12						
1616 F11-S	●	○	16	16	75	16						
1616 K11-S	●	○	16	16	125	16						
1212 G13-S	○	○	12	12	90	12						
1212 K13-S	●	○	12	12	125	12						
1616 F13-S	●	○	16	16	75	16						
1616 K13-S	●	○	16	16	125	16						
2020 K13-S	●	○	20	20	125	20						

R: Sağ / Right / Rechts L: Sol/Left/Links
● Stokta / In Stock / Auf Lager ○ Stokta Yok / Non Stock Item / Kein Lagerartikel, Lieferzeit auf Anfrage

Sipariş Örneği/Ordering Example/Bestellbeispiel
1 ad./pcs./stück SCLCR 0808 X06-S

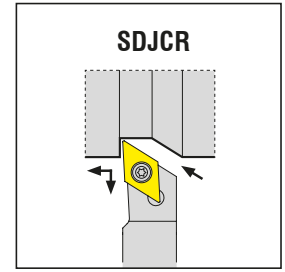
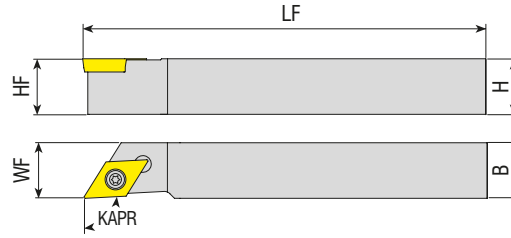
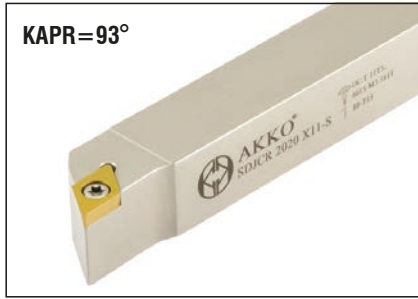

Yedek Parçaları / Spare Parts / Ersatzteile

Takım Kodu Ordering Code Bestell-Bezeichnung	Stok Stock Lager		Takım Ölçüleri (mm) Dimension (mm) Abmessung (mm)				Kesici Uç Insert Wendeschneidplatte	Sıkma Vidası Screw Schraube	Altlık Shim Unterlage	Altlık Vidası Shim Screw Schraube für Unterlage	Tork Anahtar Torx Key Torx-Schlüssel
	R	L	HF=H	B	LF	WF					
SDJCR/L 0808 X07-S	●	○	08	08	115	08	DC.T 0702..	4008-M2.5x6	-	-	80-T08
1010 X07-S	●	●	10	10	115	10					
1212 G07-S	●	○	12	12	90	12					
1212 X07-S	●	●	12	12	130	12					
1616 F07-S	●	○	16	16	75	16					
1616 X07-S	●	○	16	16	130	16					
2020 X07-S	●	○	20	20	120	20	DC.T 11T3..	4015-M3.5x11	-	-	80-T15
1212 G11-S	●	○	12	12	90	12					
1212 X11-S	●	●	12	12	130	12					
1212 K11-S	●	●	12	12	125	12					
1616 F11-S	●	○	16	16	75	16					
1616 X11-S	●	●	16	16	130	16					
1616 K11-S	●	●	16	16	125	16					
2020 X11-S	●	○	20	20	120	20					

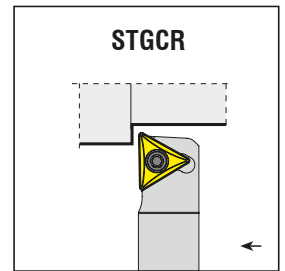
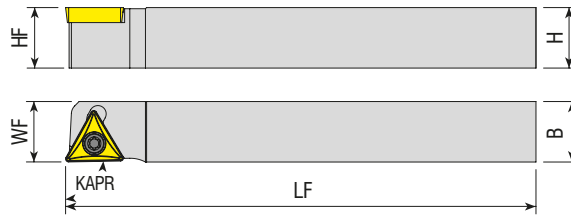

Yedek Parçaları / Spare Parts / Ersatzteile

Takım Kodu Ordering Code Bestell-Bezeichnung	Stok Stock Lager		Takım Ölçüleri (mm) Dimension (mm) Abmessung (mm)				Kesici Uç Insert Wendeschneidplatte	Sıkma Vidası Screw Schraube	Altlık Shim Unterlage	Altlık Vidası Shim Screw Schraube für Unterlage	Tork Anahtar Torx Key Torx-Schlüssel
	R	L	HF=H	B	LF	WF					
STGCR/L 1216 K11-S	●	○	12	16	125	16	TC.T 1102..	4008-M2.5x6	-	-	80-T08
1616 K11-S	●	○	16	16	125	16					
1216 K16-S	●	○	12	16	125	16	TC.T 16T3..	4015-M3.5x11	-	-	80-T15
1616 K16-S	●	○	16	16	125	16					

R: Sağ / Right / Rechts L: Sol/Left/Links
● Stokta / In Stock / Auf Lager ○ Stokta Yok / Non Stock Item / Kein Lagerartikel, Lieferzeit auf Anfrage

Sipariş Örneği/Ordering Example/Bestellbeispiel
1 ad./pcs./stück SDJCR 0808 X07-S



KAPR=93°

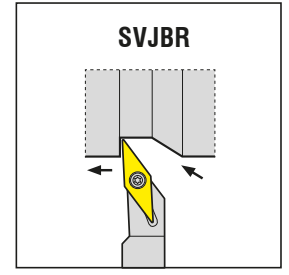
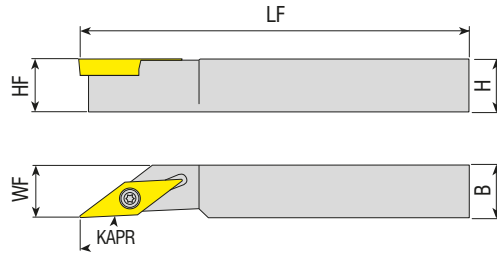

SVJBR

Takım Kodu Ordering Code Bestell-Bezeichnung	Stok Stock Lager		Takım Ölçüleri (mm) Dimension (mm) Abmessung (mm)				Kesici Uç Insert Wendeschneidplatte	Sıkma Vidası Screw Schraube	Altlık Shim Unterlage	Altlık Vidası Shim Screw Schraube für Unterlage	Tork Anahtar Torx Key Torx-Schlüssel
	R	L	HF=H	B	LF	WF					
SVJBR/L 1616 K11-S	●	●	16	16	125	16	VBM. 1103..	4008-M2.5x6	-	-	80-T08



KAPR=90°

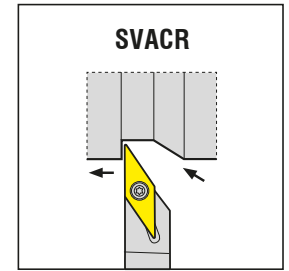
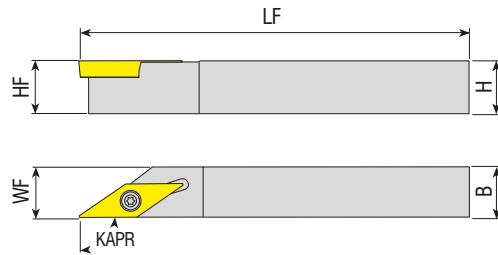

SVACR

Takım Kodu Ordering Code Bestell-Bezeichnung	Stok Stock Lager		Takım Ölçüleri (mm) Dimension (mm) Abmessung (mm)				Kesici Uç Insert Wendeschneidplatte	Sıkma Vidası Screw Schraube	Altlık Shim Unterlage	Altlık Vidası Shim Screw Schraube für Unterlage	Tork Anahtar Torx Key Torx-Schlüssel
	R	L	HF=H	B	LF	WF					
SVACR/L 0808 X11-S	○	○	08	08	115	08	VC.T 1103..	4008-M2.5x6	-	-	80-T08
1010 K11-S	●	○	10	10	125	10					
1212 G11-S	○	○	12	12	90	12					
1212 K11-S	●	●	12	12	125	12					
1616 F11-S	○	○	16	16	75	16					
1616 K11-S	●	●	16	16	125	16					
2020 K11-S	●	●	20	20	125	20					
1212 K16-S	●	●	12	12	125	12	VC.T 1604..	4015-M3.5x11			80-T15
1616 K16-S	●	●	16	16	125	16					

R: Sağ / Right / Rechts L: Sol/Left/Links

● Stokta / In Stock / Auf Lager ○ Stokta Yok / Non Stock Item / Kein Lagerartikel, Lieferzeit auf Anfrage

Sipariş Örneği/Ordering Example/Bestellbeispiel

1 ad./pcs./stück SVJBR 1616 K11-S

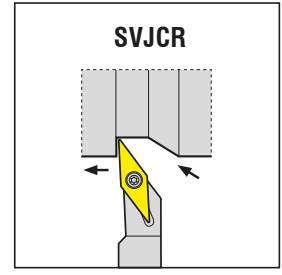
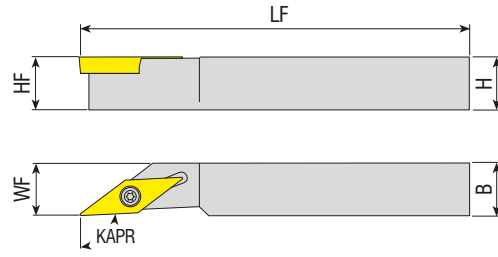

Takım Kodu Ordering Code Bestell-Bezeichnung	Stok Stock Lager		Takım Ölçüleri (mm) Dimension (mm) Abmessung (mm)				Kesici Uç Insert Wendeschneidplatte	Sıkma Vidası Screw Schraube	Altık Shim Unterlage	Altık Vidası Shim Screw Schraube für Unterlage	Tork Anahtar Torx Key Torx-Schlüssel
	R	L	HF=H	B	LF	WF					
SVJCR/L 0808 X11-S	●	○	08	08	115	08	VC.T 1103..	4008-M2.5x6	-	-	80-T08
1010 K11-S	●	○	10	10	125	10					
1212 G11-S	○	○	12	12	90	12					
1212 K11-S	●	●	12	12	125	12					
1616 F11-S	○	○	16	16	75	16					
1616 K11-S	●	○	16	16	125	16					
2020 K11-S	○	○	20	20	125	20					

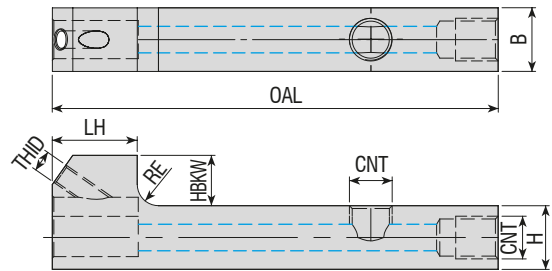

Takım Kodu Ordering Code Bestell-Bezeichnung	Stok Stock Lager	Takım Ölçüleri (mm) Dimension (mm) Abmessung (mm)								Yedek Parçaları / Spare Parts / Ersatzteile	
		H	B	RE	HBKW	LH	OAL	CNT	THID	Montaj Vidası Mounting Screw Befestigungsschraube	Anahtar Allen Key Innensechskantschlüssel
ASTB-1212-L84-H	●	12	12	4	9.5	16	84	M8x1	M4x0.7	2503-M4x12	AAL-03-3
ASTB-1616-L90-H	●	16	16	1	5.5	16	90	M8x1	M4x0.7		

R: Sağ / Right / Rechts L: Sol/Left/Links

● Stokta / In Stock / Auf Lager ○ Stokta Yok / Non Stock Item / Kein Lagerartikel, Lieferzeit auf Anfrage

Sipariş Örneği/Ordering Example/Bestellbeispiel

1 ad./pcs./stück SVJCR 0808 X11-S



KAPR=93°

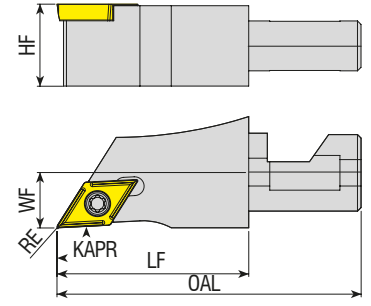

Takım Kodu Ordering Code Bestell-Bezeichnung	Stok Stock Lager		Takım Ölçüleri (mm) Dimension (mm) Abmessung (mm)					Kesici Uç Insert Wendeschneidplatte	Yedek Parçaları / Spare Parts / Ersatzteile	
	R	L	HF	WF	RE	LF	OAL	Sıkma Vidası Screw Schraube	Tork Anahtar Torx Key Torx-Schlüssel	
SDJCR/L-12X43.3-07	●	●	11.8	8	0.2	27.3	43.3	DC.T 070202	4008-M2.5x6	80-T08
SDJCR/L-16X43.3-07	●	○	15.8	8	0.2	27.3	43.3			
SDJCR/L-12X43.3-11	●	●	11.8	8	0.2	27.3	43.3	DC.T 11T302	4015-M3.5x11	80-T15
SDJCR/L-16X43.3-11	●	○	15.8	8	0.2	27.3	43.3			



KAPR=93°

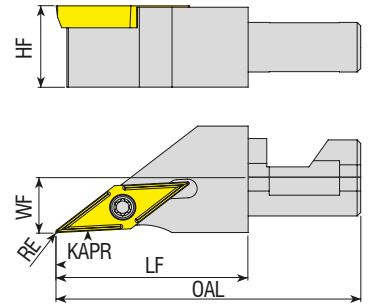

Takım Kodu Ordering Code Bestell-Bezeichnung	Stok Stock Lager		Takım Ölçüleri (mm) Dimension (mm) Abmessung (mm)					Kesici Uç Insert Wendeschneidplatte	Yedek Parçaları / Spare Parts / Ersatzteile	
	R	L	HF	WF	RE	LF	OAL	Sıkma Vidası Screw Schraube	Tork Anahtar Torx Key Torx-Schlüssel	
SVJCR/L-12-43.3-11	●	●	11.8	8	0.2	27.3	43.3	VC.T 110202	4008-M2.5x6	80-T08
SVJCR/L-16-43.3-11	●	●	15.8	8	0.2	27.3	43.3			

R: Sağ / Right / Rechts L: Sol/Left/Links

● Stokta / In Stock / Auf Lager ○ Stokta Yok / Non Stock Item / Kein Lagerartikel, Lieferzeit auf Anfrage

Sipariş Örneği/Ordering Example/Bestellbeispiel

1 ad./pcs./stück SDJCR-12X43.3 07

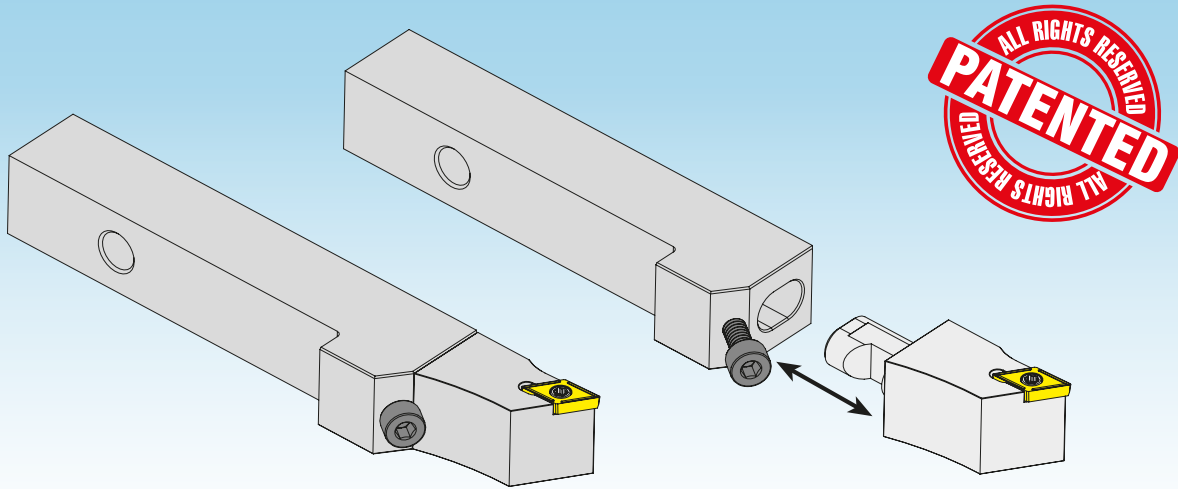

Takım tutucuyu, bağlama ünitesinden sökme zorunluğuna kalmadan hızlıca değiştirin!

Quick change, without having to remove the tool-holder from the gang !

Es ist nicht nötig, den Grundhalter vom Werkzeugträger zu entfernen schnelle wechsel möglich!

Makina dışında ön ayar yapmak mümkün.

Presetting is possible outside of the machine.

Voreinstellung ausserhalb der Maschine ist möglich.

Çok hassas montaj.

Ultra precise fitting.

Ultra-präziser Montage.

Rijit sabitleme.

Rigid fixation.

Starre Befestigung.

Takım tutucu bölümü: 12x12 ve 16x16 mm.

Tool-holder section : 12x12 and 16x16 mm.

Grundhalter: 12x12 und 16x16mm.

Sağ ve sol uçlar kullanılır.

Left and right inserts available.

Links und Rechts WSP verwendbar.

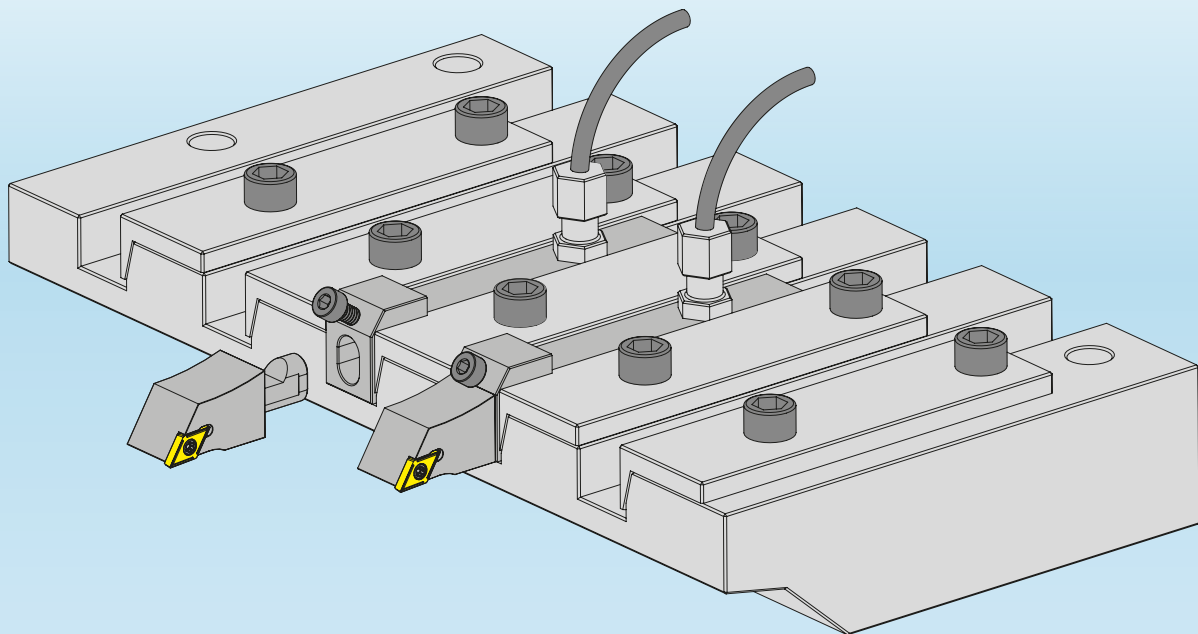
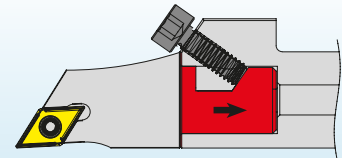



DELİK TORNA TAKIMLARI
INTERNAL TURNING TOOLHOLDERS
DREHWERKZEUGE FÜR DIE INNENBEARBEITUNG





1 Takım Malzemesi / Type of Boring Bar / Art der Bohrstange

A Yekpare çelik gövde soğutma suyu kanallı / "A" Solid steel with coolant hole
 **A* Vollstahlausführung mit innere Kühlmittelzufuhr
 E Çelik başlıkla sert metal gövde ve soğutma suyu kanallı / "E" Carbide bar with fixed steel head and coolant hole
 E Hartmetallschaft mit Kopf aus Stahl und innere Kühlmittelzufuhr
 C Karbür Şaft / "C" Carbide shank / *C* Hartmetallschaft mit Kopf aus Stahl ohne innere Kühlmittelzufuhr
 S Çelik Şaft / "S" Steel shank / *S* Vollstahlausführung ohne innere Kühlmittelzufuhr

2 Şaft Çapı / Shank Diameter / Schaft Durchmesser

3 Şaft Boyu / Shank Length / Schaft Länge

4 Sıkma Tipi / Method of Mounting of Insert / Art der Schneideplattenbefestigung

C	T	M	P	S

A-32	H-100	Q-180	x-special
B-40	J-110	R-200	
C-50	K-125	S-250	
D-60	L-140	T-300	
E-70	M-150	U-350	
F-80	N-160	V-400	
G-90	P-170	W-450	

(mm)

5 Uç Tipi / Type of Insert / Plattenform

C	D	E
V	R	S
W	K	T

6 Yanaşma Açısı / Tool Holder Shape Bar Geometry / Anstellwinkel

7 Serbest Uç Açısı / Insert Clearance Angle / Freiwinkel

8 Kesme Yönü / Cutting Direction / Halterausführung

9 Kesme Kenar Uzunluğu / Cutting Edge Length / Schneidkantenlänge

10 Baskı Pabucu / Wedge Clamp / Spannpratze



T&C-SİSTEM

T&C SİSTEM DELİK TORNA KATERLERİ
T&C SYSTEM BORING BARS
T&C SYSTEM BOHRSTANGE

*konusulan
the spoken kalite...
quality...*



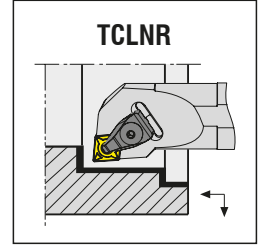
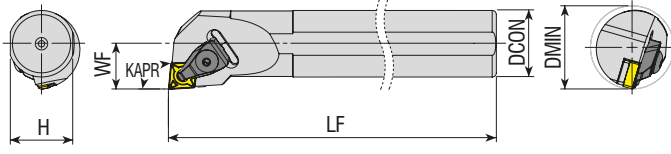

Takım Kodu Ordering Code Bestell-Bezeichnung	Stok Stock Lager		Takım Ölçüleri (mm) Dimension (mm) Abmessung (mm)				Kesici Uç Insert Wendeschneidplatte	Baskı Pabucu Wedge Clamp Spannpratze	Pabuç Vidası Clamp Screw Klemmschraube	Yedek Parçaları / Spare Parts / Ersatzteile					
	R	L	DCON	H	LF	WF				DMIN	Altlık Shim Unterlage	Altlık Vidası Shim Screw Schraube für Unterlage	Sekman Ring Feder	Pul Stamp Ring	Anahtar Allen Key Innerschlüsselschlüssel
S25S TCLNR/L 09	●	●	25	23	250	17	≥32	CNM. 0903..	ATK-01	AKV-01-M5x22	AACN-2-0001	AAV-09-M5x9	-		
S25S TCLNR/L 12	●	●	25	23	250	17	≥32					AAV-13-M5x8			
S32T TCLNR/L 12	●	●	32	30	300	22	≥40	CNM. 1204..	ATK-02	AKV-30-M6x22	AACN-3-0001	AAV-02-M5x12	AS-01	ABPL-01	AAL-03-3
S40U TCLNR/L 12	●	●	40	37.5	350	27	≥50								
S50V TCLNR/L 12	●	●	50	47	400	35	≥63								
S32T TCLNR/L 16	●	●	32	30	300	22	≥40								
S40U TCLNR/L 16	●	●	40	37.5	350	27	≥50	CNM. 1606..	ATK-04	AKV-19-M7x25	AACN-3-0002	AAV-05-M6x15	-	ABPL-02	AAL-05-4
S50V TCLNR/L 16	●	●	50	47	400	35	≥63								

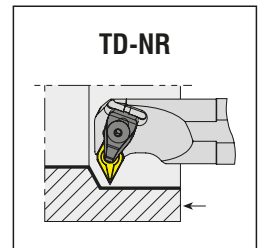
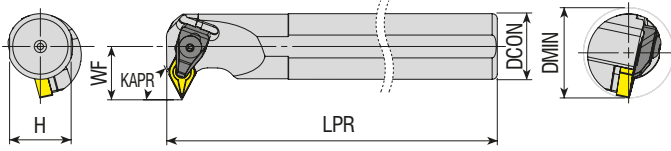

Takım Kodu Ordering Code Bestell-Bezeichnung	Stok Stock Lager		Takım Ölçüleri (mm) Dimension (mm) Abmessung (mm)				Kesici Uç Insert Wendeschneidplatte	Baskı Pabucu Wedge Clamp Spannpratze	Pabuç Vidası Clamp Screw Klemmschraube	Yedek Parçaları / Spare Parts / Ersatzteile					
	R	L	DCON	H	LPR	WF				DMIN	Altlık Shim Unterlage	Altlık Vidası Shim Screw Schraube für Unterlage	Sekman Ring Feder	Pul Stamp Ring	Anahtar Allen Key Innerschlüsselschlüssel
S32T TD-NR/L 15	●	●	32	30	300	26	≥44								
S40U TD-NR/L 15	●	●	40	37.5	350	29	≥52	DNM. 1506..	ATK-02	AKV-30-M6x22	AADN-3-0001	AAV-02-M5x12	AS-01	ABPL-01	AAL-03-3
S50V TD-NR/L 15	●	●	50	47	400	35	≥63								

R: Sağ / Right / Rechts L: Sol/Left/Links

● Stokta / In Stock / Auf Lager ○ Stokta Yok / Non Stock Item / Kein Lagerartikel, Lieferzeit auf Anfrage

Sipariş Örneği/Ordering Example/Bestellbeispiel

1 ad./pcs./stück S25S TCLNR 09

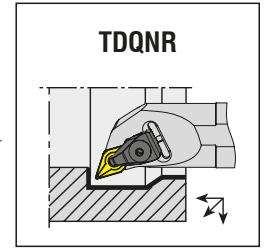
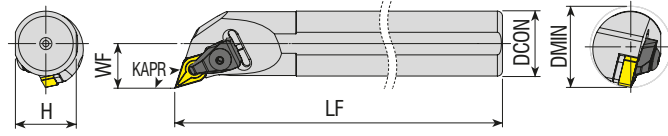

Takım Kodu Ordering Code Bestell-Bezeichnung	Stok Stock Lager		Takım Ölçüleri (mm) Dimension (mm) Abmessung (mm)					Kesici Uç Insert Wendeschneidplatte	Yedek Parçaları / Spare Parts / Ersatzteile						
	R	L	DCON	H	LF	WF	DMIN		Baskı Pabucu Wedge Clamp Spannpratze	Pabuç Vidası Clamp Screw Klemmschraube	Altlık Shim Unterlage	Altlık Vidası Shim Screw Schraube für Unterlage	Sekman Ring Feder	Pul Stamp Ring	Anahtar Allen Key Innensechskantschlüssel
S25S TDQNR/L 11	●	●	25	23	250	17	≥32	DNM. 1104..	ATK-01	AKV-01-M5x22	AADN-2-0001	AAV-09-M5x9	-	ABPL-01	AAL-03-3
S32T TDQNR/L 11	●	●	32	30	300	22	≥40					AAV-04-M5x12			
S25S TDQNR/L 15	●	●	25	23	250	17	≥32	DNM. 1506..	ATK-02	AKV-30-M6x22	AADN-3-0001	AAV-13-M5x8	AS-01	ABPL-01	AAL-03-3
S32T TDQNR/L 15	●	●	32	30	300	22	≥40					AAV-02-M5x12			
S40U TDQNR/L 15	●	●	40	37.5	350	27	≥50								
S50V TDQNR/L 15	●	●	50	47	400	35	≥63								

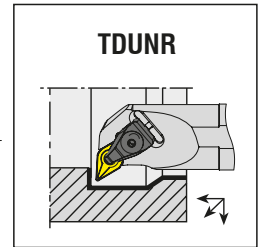
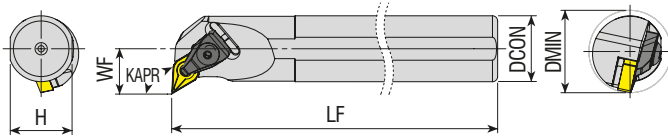

Takım Kodu Ordering Code Bestell-Bezeichnung	Stok Stock Lager		Takım Ölçüleri (mm) Dimension (mm) Abmessung (mm)					Kesici Uç Insert Wendeschneidplatte	Yedek Parçaları / Spare Parts / Ersatzteile						
	R	L	DCON	H	LF	WF	DMIN		Baskı Pabucu Wedge Clamp Spannpratze	Pabuç Vidası Clamp Screw Klemmschraube	Altlık Shim Unterlage	Altlık Vidası Shim Screw Schraube für Unterlage	Sekman Ring Feder	Pul Stamp Ring	Anahtar Allen Key Innensechskantschlüssel
S25S TDUNR/L 11	●	●	25	23	250	17	≥32	DNM. 1104..	ATK-01	AKV-01-M5x22	AADN-2-0001	AAV-09-M5x9	-	ABPL-01	AAL-03-3
S32T TDUNR/L 11	●	●	32	30	300	22	≥40					AAV-04-M5x12			
S25S TDUNR/L 15	●	●	25	23	250	17	≥34	DNM. 1506..	ATK-02	AKV-30-M6x22	AADN-3-0001	AAV-13-M5x8	AS-01	ABPL-01	AAL-03-3
S32T TDUNR/L 15	●	●	32	30	300	22	≥40					AAV-02-M5x12			
S40U TDUNR/L 15	●	●	40	37.5	350	27	≥50								
S50V TDUNR/L 15	●	●	50	47	400	35	≥63								

R: Sağ / Right / Rechts L: Sol/Left/Links

● Stokta / In Stock / Auf Lager ○ Stokta Yok / Non Stock Item / Kein Lagerartikel, Lieferzeit auf Anfrage

Sipariş Örneği/Ordering Example/Bestellbeispiel

1 ad./pcs./stück S25S TDQNR 11

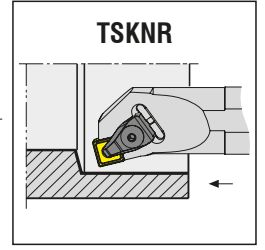
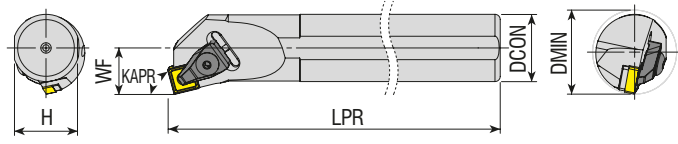

Takım Kodu Ordering Code Bestell-Bezeichnung	Stok Stock Lager		Takım Ölçüleri (mm) Dimension (mm) Abmessung (mm)					Kesici Uç Insert Wendeschneidplatte	Baskı Pabuçu Wedge Clamp Spannpratze	Pabuç Vidası Clamp Screw Klemmschraube	Yedek Parçaları / Spare Parts / Ersatzteile						
	R	L	DCON	H	LPR	WF	DMIN				Altık Shim Unterlage	Altık Vidası Shim Screw Schraube für Unterlage	Sekman Ring Feder	Pul Stamp Ring	Anahtar Allen Key Innerschraubenschlüssel		
S25S TSKNR/L 12	●	●	25	23	250	17	≥32	SNM. 1204..	ATK-02	AKV-30-M6x22	AASN-3-0004	AAV-13-M5x8	AS-01	ABPL-01	AAL-03-3		
S32T TSKNR/L 12	●	●	32	30	300	22	≥40										
S40U TSKNR/L 12	●	●	40	37.5	350	27	≥50										

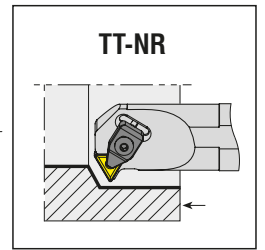
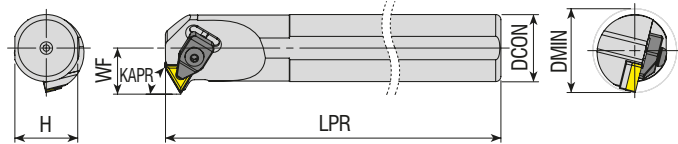

Takım Kodu Ordering Code Bestell-Bezeichnung	Stok Stock Lager		Takım Ölçüleri (mm) Dimension (mm) Abmessung (mm)					Kesici Uç Insert Wendeschneidplatte	Baskı Pabuçu Wedge Clamp Spannpratze	Pabuç Vidası Clamp Screw Klemmschraube	Yedek Parçaları / Spare Parts / Ersatzteile						
	R	L	DCON	H	LPR	WF	DMIN				Altık Shim Unterlage	Altık Vidası Shim Screw Schraube für Unterlage	Yay Spring Feder	Pul Stamp Ring	Anahtar Allen Key Innerschraubenschlüssel		
S25S TT-NR/L 16	●	●	25	23	250	17	≥32	TNM. 1604..	ATK-01	AKV-01-M5x22	AATN-2-0002	AAV-03-M5x12	-	ABPL-01	AAL-03-3		
S32T TT-NR/L 16	●	●	32	30	300	22	≥40										

R: Sağ / Right / Rechts L: Sol/Left/Links

● Stokta / In Stock / Auf Lager ○ Stokta Yok / Non Stock Item / Kein Lagerartikel, Lieferzeit auf Anfrage

Sipariş Örneği/Ordering Example/Bestellbeispiel

1 ad./pcs./stück S25S TSKNR 12

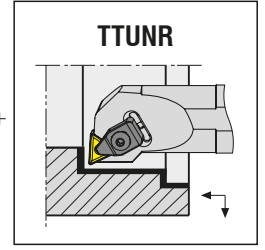
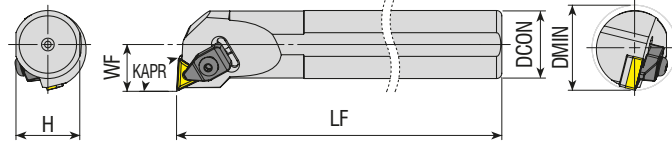
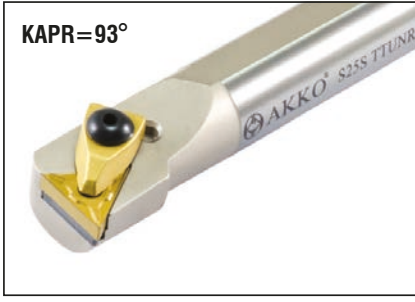

Takım Kodu Ordering Code Bestell-Bezeichnung	Stok Stock Lager		Takım Ölçüleri (mm) Dimension (mm) Abmessung (mm)					Kesici Uç Insert Wendeschneidplatte	Baskı Pabucu Wedge Clamp Spannpratze	Pabuç Vidası Clamp Screw Klemmschraube	Altlık Shim Unterlage	Altlık Vidası Shim Screw Schraube für Unterlage	Sekman Ring Feder	Pul Stamp Ring	Anahtar Allen Key Inmenschenschlüssel
	R	L	DCON	H	LF	WF	DMIN								
S25S TTUNR/L 16	●	●	25	23	250	17	≥32	TNM. 1604..	ATK-01	AKV-01-M5x22	AATN -2-0002	AAV-03-M5x12	-	ABPL-01	AAL-03-3
S32T TTUNR/L 16	●	●	32	30	300	22	≥40								
S25S TTUNR/L 22	●	●	25	23	250	17	≥32	TNM. 2204..	ATK-02	AKV-30-M6x22	AATN -3-0015	AAV-02-M5x12	AS-01	ABPL-01	AAL-03-3
S32T TTUNR/L 22	●	●	32	30	300	22	≥40								
S40U TTUNR/L 22	●	●	40	37.5	350	27	≥50								
S50V TTUNR/L 22	●	●	50	47	400	35	≥63								

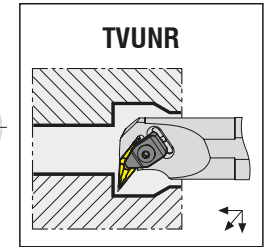
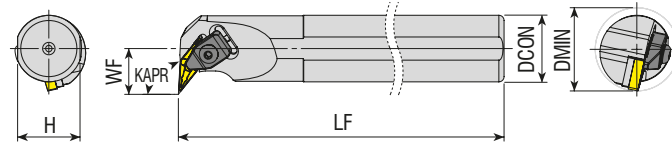
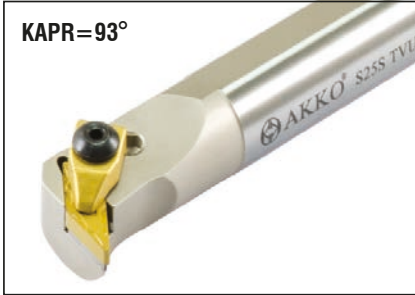

Takım Kodu Ordering Code Bestell-Bezeichnung	Stok Stock Lager		Takım Ölçüleri (mm) Dimension (mm) Abmessung (mm)					Kesici Uç Insert Wendeschneidplatte	Baskı Pabucu Wedge Clamp Spannpratze	Pabuç Vidası Clamp Screw Klemmschraube	Altlık Shim Unterlage	Altlık Vidası Shim Screw Schraube für Unterlage	Yay Spring Feder	Pul Stamp Ring	Anahtar Allen Key Inmenschenschlüssel
	R	L	DCON	H	LF	WF	DMIN								
S25S TVUNR/L 16	●	●	25	23	250	20	≥36	VNM. 1604..	ATK-01	AKV-01-M5x22	AAVN -2-0002	AAV-04-M5x12	-	ABPL-01	AAL-03-3
S32T TVUNR/L 16	●	●	32	30	300	22	≥40								
S40U TVUNR/L 16	●	●	40	37.5	350	27	≥50								

R: Sağ / Right / Rechts L: Sol/Left/Links

● Stokta / In Stock / Auf Lager ○ Stokta Yok / Non Stock Item / Kein Lagerartikel, Lieferzeit auf Anfrage

Sipariş Örneği/Ordering Example/Bestellbeispiel

1 ad./pcs./stück S25S TTUNR 16

➤ **T-SİSTEM DELİK TORNA KATERLERİ**
T-SYSTEM BORING BARS
T-SYSTEM BOHRSTANGE

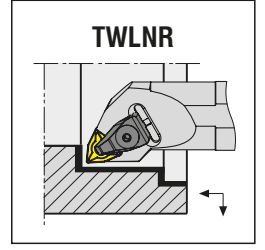
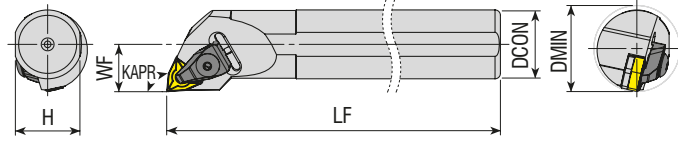

Takım Kodu Ordering Code Bestell-Bezeichnung	Stok Stock Lager		Takım Ölçüleri (mm) Dimension (mm) Abmessung (mm)					Kesici Uç Insert Wendeschneidplatte	Baskı Pabucu Wedge Clamp Spannpratze	Pabuç Vidası Clamp Screw Klemmschraube	Yedek Parçaları / Spare Parts / Ersatzteile		Sekman Ring Feder	Pul Stamp Ring	Anahtar Allen Key Innerschloßschlüssel
	R	L	DCON	H	LF	WF	DMIN				Altık Shim Unterlage	Altık Vidası Shim Screw Schraube für Unterlage			
S25S TWLNR/L 06	●	●	25	23	250	17	≥32	WNM. 0604..	ATK-01	AKV-01-M5x22	AAWN-SW317	AAV-01-M3x10	-		
S32T TWLNR/L 06	●	●	32	30	300	22	≥40				AAV-13-M5x8				
S25S TWLNR/L 08	●	●	25	23	250	17	≥32	WNM. 0804..	ATK-02	AKV-30-M6x22	AAWN-3-0001	AAV-02-M5x12	AS-01	ABPL-01	AAL-03-3
S32T TWLNR/L 08	●	●	32	30	300	22	≥40								
S40U TWLNR/L 08	●	●	40	37.5	350	27	≥50								
S50V TWLNR/L 08	●	●	50	47	400	35	≥63								
A40T TWLNR/L 08	●	○	40	37.5	300	27	≥50								
A50U TWLNR/L 08	●	○	50	47	350	35	≥63								

➤ **C-SİSTEM DELİK TORNA KATERLERİ**
C-SYSTEM BORING BARS
C-SYSTEM BOHRSTANGE

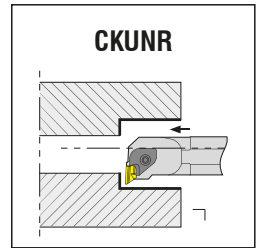
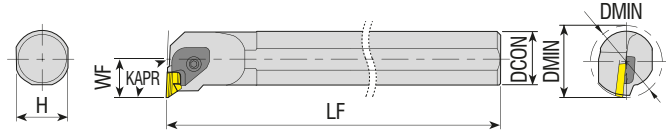

Takım Kodu Ordering Code Bestell-Bezeichnung	Stok Stock Lager		Takım Ölçüleri (mm) Dimension (mm) Abmessung (mm)					Kesici Uç Insert Wendeschneidplatte	Baskı Pabucu Wedge Clamp Spannpratze	Pabuç Vidası Clamp Screw Klemmschraube	Yedek Parçaları / Spare Parts / Ersatzteile		Yay Spring Feder	Pul Stamp Ring	Anahtar Allen Key Innerschloßschlüssel
	R	L	DCON	H	LF	WF	DMIN				Altık Shim Unterlage	Altık Vidası Shim Screw Schraube für Unterlage			
S25S CKUNR/L 16	●	●	25	23	250	19	≥38	KNUX 1604..	ACK-01-R ACK-02-L	AKV-06-M6x20	AKS-16-R	AAV-01-M3x10	AKY-02	ABPL-01	AAL-05-4
S32T CKUNR/L 16	●	●	32	30	300	22	≥40				AKS-16-L				
S40U CKUNR/L 16	●	●	40	37.5	350	27	≥50								
S50V CKUNR/L 16	●	●	50	47	400	35	≥63								

R: Sağ / Right / Rechts L: Sol/Left/Links

● Stokta / In Stock / Auf Lager ○ Stokta Yok / Non Stock Item / Kein Lagerartikel, Lieferzeit auf Anfrage

Sipariş Örneği/Ordering Example/Bestellbeispiel

1 ad./pcs./stück S25S TWLNR 06



www.akko.com.tr



M-SİSTEM

M-SİSTEM DELİK TORNA KATERLERİ
M-SYSTEM BORING BARS
M-SYSTEM BOHRSTANGE

*konusulan
the spoken kalite...
quality...*



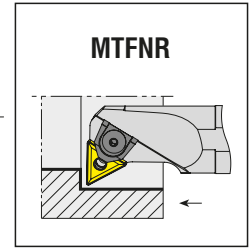
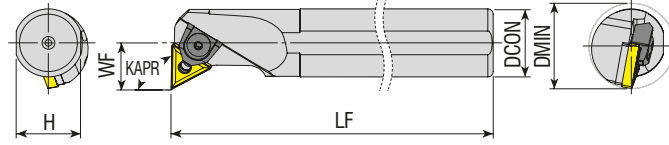
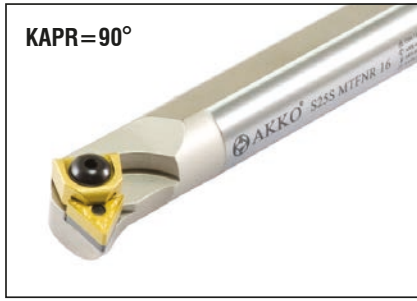

Takım Kodu Ordering Code Bestell-Bezeichnung	Stok Stock Lager		Takım Ölçüleri (mm) Dimension (mm) Abmessung (mm)				Kesici Uç Insert Wendeschneidplatte	Baskı Pabucu Wedge Clamp Spannpratze	Pabuç Vidası Clamp Screw Klemmschraube	Yedek Parçaları / Spare Parts / Ersatzteile					
	R	L	DCON	H	LF	WF				DMIN	Aitlik Shim Unterlage	Pim Pin Passstift	Sekman Ring Feder	Pul Stamp Ring	Anahtar Allen Key Innerschlüssel
S20R MTFNR/L 16	●	●	20	18.3	200	14	≥25	TNM. 1604..	AMK-02	AKV-17-M5x15	-	APM-03	-	-	AAL-03-3
S25S MTFNR/L 16	●	●	25	23	250	17	≥32				AATN-2-0002	APM-14			
S32T MTFNR/L 16	●	●	32	30	300	22	≥40					APM-01	AS-01	ABPL-01	
S40U MTFNR/L 16	●	●	40	37.5	350	27	≥50	TNM. 2204..	AMK-04	AKV-30-M6x22					
S32T MTFNR/L 22	●	●	32	30	300	22	≥40				AATN-3-0015	APM-02			
S40U MTFNR/L 22	●	●	40	37.5	350	27	≥50								
S50V MTFNR/L 22	●	○	50	47	400	35	≥63								

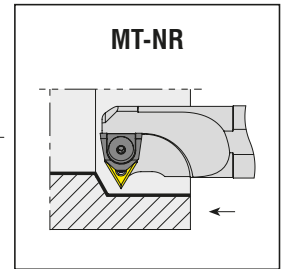
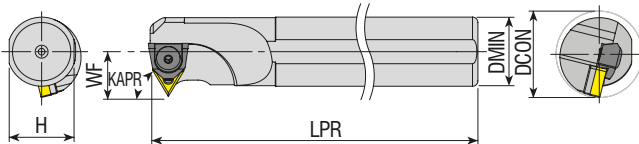

Takım Kodu Ordering Code Bestell-Bezeichnung	Stok Stock Lager		Takım Ölçüleri (mm) Dimension (mm) Abmessung (mm)				Kesici Uç Insert Wendeschneidplatte	Baskı Pabucu Wedge Clamp Spannpratze	Pabuç Vidası Clamp Screw Klemmschraube	Yedek Parçaları / Spare Parts / Ersatzteile					
	R	L	DCON	H	LPR	WF				DMIN	Aitlik Shim Unterlage	Pim Pin Passstift	Sekman Ring Feder	Pul Stamp Ring	Anahtar Allen Key Innerschlüssel
S20R MT-NR/L 16	●	●	20	18.3	200	16	≥26	TNM. 1604..	AMK-02	AKV-04-M5x17	-	APM-03	-	-	AAL-03-3
S25S MT-NR/L 16	●	●	25	23	250	17	≥32				AATN-2-0002	APM-14			
S32T MT-NR/L 16	●	●	32	30	300	22	≥40					APM-01	AS-01	ABPL-01	
S40U MT-NR/L 16	●	●	40	37.5	350	27	≥50	TNM. 2204..	AMK-04	AKV-30-M6x22	AATN-3-0015	APM-02			
S32T MT-NR/L 22	●	●	32	30	300	24	≥40								
S40U MT-NR/L 22	●	●	40	37.5	350	27	≥50								
S50U MT-NR/L 22	●	●	50	47	350	35	≥63								

R: Sağ / Right / Rechts L: Sol/Left/Links
● Stokta / In Stock / Auf Lager ○ Stokta Yok / Non Stock Item / Kein Lagerartikel, Lieferzeit auf Anfrage

Sipariş Örneği/Ordering Example/Bestellbeispiel
1 ad./pcs./stück S20R MTFNR 16

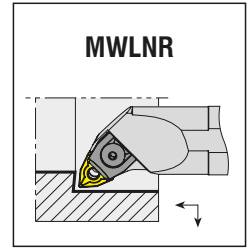
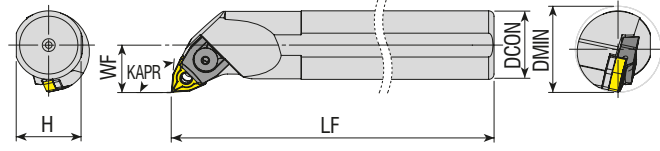

Takım Kodu Ordering Code Bestell-Bezeichnung	Stok Stock Lager		Takım Ölçüleri (mm) Dimension (mm) Abmessung (mm)				Kesici Uç Insert Wendeschneidplatte	Baskı Pabucu Wedge Clamp Spannpratze	Pabuç Vidası Clamp Screw Klemmschraube	Yedek Parçaları / Spare Parts / Ersatzteile					
	R	L	DCON	H	LF	WF				DMIN	Aitlik Shim Unterlage	Pim Pin Passstift	Sekman Ring Feder	Pul Stamp Ring	Anahtar Allen Key Innenschlüssel
S16P MWLNR/L 06	●	●	16	14.8	170	11	≥20	WWM. 0604..	AMK-01	AKV-17-M5x15	-	APM-09	-	-	AAL-03-3
S20R MWLNR/L 06	●	●	20	18.3	200	13	≥25			AKV-04-M5x17		APM-10			
S25S MWLNR/L 06	●	●	25	23	250	17	≥32			AKV-27-M6x20		APM-08			
S25S MWLNR/L 08	●	●	25	23	250	17	≥32	WWM. 0804..	AMK-05	AKV-03-M6x22	AAWN-3-0001	APM-04	AS-01	ABPL-01	
S32T MWLNR/L 08	●	●	32	30	300	22	≥40				APM-02				
S40U MWLNR/L 08	●	●	40	37.5	350	27	≥50								

R: Sağ / Right / Rechts L: Sol/Left/Links
● Stokta / In Stock / Auf Lager ○ Stokta Yok / Non Stock Item / Kein Lagerartikel, Lieferzeit auf Anfrage

Sipariş Örneği/Ordering Example/Bestellbeispiel
1 ad./pcs./stück S16P MWLNR 06





*konusulan
the spoken kalite...
quality...*

P-SİSTEM

P-SİSTEM DELİK TORNA KATERLERİ
P-SYSTEM BORING BARS
P-SYSTEM BOHRSTANGE



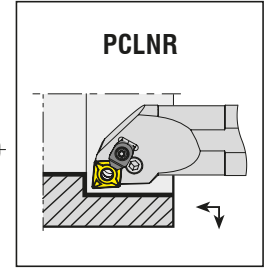
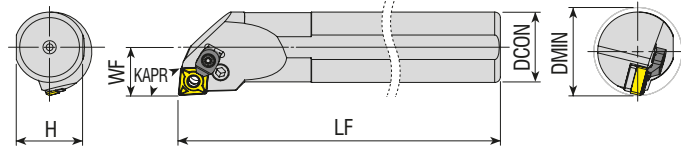

Takım Kodu Ordering Code Bestell-Bezeichnung	Stok Stock Lager		Takım Ölçüleri (mm) Dimension (mm) Abmessung (mm)				Kesici Uç Insert Wendeschneidplatte	Yedek Parçaları / Spare Parts / Ersatzteile							
	R	L	DCON	H	LF	WF		DMIN	Levyeye Lever Kniehebel	Levyeye Vidası Lever Screw Kniehebelschraube	Altık Shim Unterlage	Altık Yay Shim Spring Feder für Unterlage	Baskı Pabucu Wedge Clamp Spannpratze	Pabuç Vidası Clamp Screw Klemmschraube	Anahtar Allen Key Inmenschenschlüssel
S16P PCLNR/L 09	●	●	16	14.8	170	11	≥20	CNM. 0903..	APL-07	ALV-07-M6x13	-	AAY-07	-	-	AAL-02-2.5
S20R PCLNR/L 09	●	●	20	18.3	200	13	≥25		APL-01	ALV-02-M6x17	AACN-2-0002	AAY-01	-	-	AAL-02-2.5
S25S PCLNR/L 09	●	○	25	23	250	17	≥32			ALV-08-M8x16					
S25S PCLNR/L 12C	●	●	25	23	250	17	≥32	CNM. 1204..	APL-02	ALV-03-M8x19	AACN-3-0001	AAY-02	ACK-05	4015-M4x11	AAL-03-3
S32T PCLNR/L 12C	●	●	32	30	300	22	≥40								
S40U PCLNR/L 12C	●	●	40	37.5	350	27	≥50								
S50V PCLNR/L 12C	●	●	50	47	400	35	≥63								
S32T PCLNR/L 16C	●	●	32	30	300	22	≥40	CNM. 1606..	APL-04	ALV-04-M8x22	AACN-3-0002	AAY-03	ACK-09	AAV-05-M6x15	AAL-03-3
S40U PCLNR/L 16C	●	●	40	37.5	350	27	≥50								
S50V PCLNR/L 16C	●	●	50	47	400	35	≥63								
S40U PCLNR/L 19C	●	●	40	37.5	350	27	≥50	CNM. 1906..	APL-05	ALV-05-M10x27	AACN-3-0003	AAY-04	ACK-09	AAV-05-M6x15	AAL-05-4
S50V PCLNR/L 19C	●	●	50	47	400	35	≥63								
A25R PCLNR/L 12C	●	●	25	23	200	17	≥32			ALV-08-M8x16					
A32S PCLNR/L 12C	●	●	32	30	250	22	≥40	CNM. 1204..	APL-02	ALV-03-M8x19	AACN-3-0001	AAY-02	ACK-05	4015-M4x11	AAL-03-3
A40T PCLNR/L 12C	●	●	40	37.5	300	27	≥50								
A50U PCLNR/L 12C	●	●	50	47	350	35	≥63								
A32S PCLNR/L 16C	●	●	32	30	250	22	≥40	CNM. 1606..	APL-04	ALV-04-M8x22	AACN-3-0002	AAY-03	ACK-09	AAV-05-M6x15	AAL-03-3
A40T PCLNR/L 16C	●	●	40	37.5	300	27	≥50								
A50U PCLNR/L 16C	●	●	50	47	350	35	≥63								
A40T PCLNR/L 19C	●	●	40	37.5	300	27	≥50	CNM. 1906..	APL-05	ALV-05-M10x27	AACN-3-0003	AAY-04	ACK-09	AAV-05-M6x15	AAL-05-4
A50U PCLNR/L 19C	●	●	50	47	350	35	≥63								

R: Sağ / Right / Rechts L: Sol/Left/Links

● Stokta / In Stock / Auf Lager ○ Stokta Yok / Non Stock Item / Kein Lagerartikel, Lieferzeit auf Anfrage

Sipariş Örneği/Ordering Example/Bestellbeispiel

1 ad./pcs./stück S16P PCLNR 09

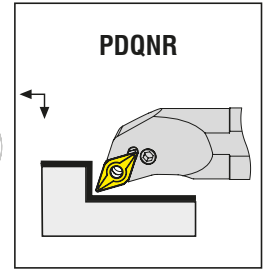
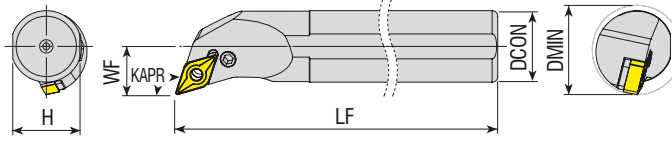

Takım Kodu Ordering Code Bestell-Bezeichnung	Stok Stock Lager		Takım Ölçüleri (mm) Dimension (mm) Abmessung (mm)					Kesici Uç Insert Wendeschneidplatte	Yedek Parçaları / Spare Parts / Ersatzteile						
	R	L	DCON	H	LF	WF	DMIN		Levye Lever Kniehebel	Levye Vidası Lever Screw Kniehebelschraube	Altlık Shim Unterlage	Altlık Yayısı Shim Spring Feder für Unterlage	Baskı Pabuçu Wedge Clamp Spannpratze	Pabuç Vidası Clamp Screw Klemmschraube	Anahtar Allen Key Immerstschlüssel
S20R PDQNR/L 11	●	○	20	18.3	200	13	≥25	DNM. 1104..	APL-01	ALV-01-M6x14 ALV-02-M6x17	AADN-SD317	AAY-01			AAL-02-2.5
S25S PDQNR/L 11	●	●	25	23	250	17	≥32								
S32T PDQNR/L 15	●	●	32	30	300	22	≥40	DNM. 1506..	APL-03	ALV-03-M8x19	AADN-3-0001	AAY-02	-	-	AAL-03-3
S40U PDQNR/L 15	●	●	40	37.5	350	27	≥50								
S50V PDQNR/L 15	●	●	50	47	400	35	≥63	DNM. 1504..	APL-03	ALV-03-M8x19	AADN-2-0003	AAY-02	-	-	AAL-03-3
S32T PDQNR/L 1504	●	●	32	30	300	22	≥40								
S40U PDQNR/L 1504	●	●	40	37.5	350	27	≥50	DNM. 1504..	APL-03	ALV-03-M8x19	AADN-2-0003	AAY-02	-	-	AAL-03-3
S50V PDQNR/L 1504	●	●	50	47	400	35	≥63								
A20P PDQNR/L 11	●	●	20	18.3	170	13	≥25	DNM. 1104..	APL-01	ALV-01-M6x14 ALV-02-M6x17	AADN-SD317	AAY-01	-	-	AAL-02-2.5
A25R PDQNR/L 11	●	●	25	23	200	17	≥32								
A32S PDQNR/L 15	●	●	32	30	250	22	≥40	DNM. 1506..	APL-03	ALV-03-M8x19	AADN-3-0001	AAY-02	-	-	AAL-03-3
A40T PDQNR/L 15	●	●	40	37.5	300	27	≥50								
A50U PDQNR/L 15	●	●	50	47	350	35	≥63	DNM. 1504..	APL-03	ALV-03-M8x19	AADN-2-0003	AAY-02	-	-	AAL-03-3
A32S PDQNR/L 1504	●	●	32	30	250	22	≥40								
A40T PDQNR/L 1504	●	●	40	37.5	300	27	≥50								

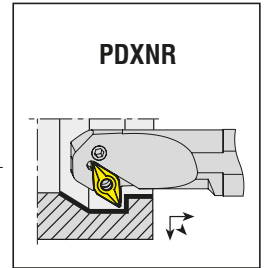
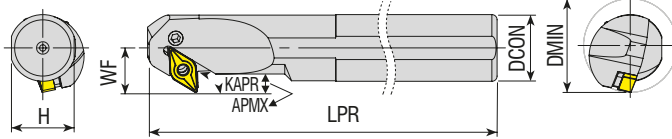

Takım Kodu Ordering Code Bestell-Bezeichnung	Stok Stock Lager		Takım Ölçüleri (mm) Dimension (mm) Abmessung (mm)						Kesici Uç Insert Wendeschneidplatte	Yedek Parçaları / Spare Parts / Ersatzteile						
	R	L	DCON	H	LPR	WF	APMX	DMIN		Levye Lever Kniehebel	Levye Vidası Lever Screw Kniehebelschraube	Altlık Shim Unterlage	Altlık Yayısı Shim Spring Feder für Unterlage	Baskı Pabuçu Wedge Clamp Spannpratze	Pabuç Vidası Clamp Screw Klemmschraube	Anahtar Allen Key Immerstschlüssel
S32T PDXNR/L 15	●	●	32	30	300	22	12	≥45	DNM. 1506..	APL-03	ALV-08-M8x16 ALV-03-M8x19	AADN-3-0001	AAY-02	-	-	AAL-03-3
S40U PDXNR/L 15	●	●	40	37.5	350	27	14	≥50								
S50V PDXNR/L 15	●	●	50	47	400	35	19	≥63								

R: Sağ / Right / Rechts L: Sol/Left/Links
● Stokta / In Stock / Auf Lager ○ Stokta Yok / Non Stock Item / Kein Lagerartikel, Lieferzeit auf Anfrage

Sipariş Örneği/Ordering Example/Bestellbeispiel
1 ad./pcs./stück S20R PDQNR 11

Not: "APMX" ölçüleri R0.8'e göre verilmiştir.
Note: Dimensions of "AMPX" are given according to R.08.
Hinweis: Maß "APMX" gilt für Eckenradius 0,4 mm

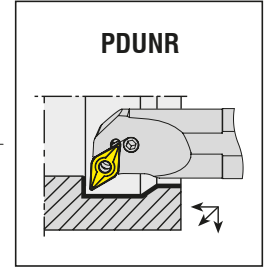
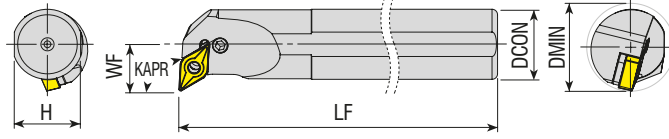

Takım Kodu Ordering Code Bestell-Bezeichnung	Stok Stock Lager		Takım Ölçüleri (mm) Dimension (mm) Abmessung (mm)					Kesici Uç Insert Wendeschneidplatte	Yedek Parçaları / Spare Parts / Ersatzteile						
	R	L	DCON	H	LF	WF	DMIN		Levyé Lever Kniehebel	Levyé Vidası Lever Screw Kniehebelschraube	Altılık Shim Unterlage	Altılık Yayı Shim Spring Feder für Unterlage	Baskı Pabucu Wedge Clamp Spannpratze	Pabuç Vidası Clamp Screw Klemmschraube	Anahtar Allen Key Innensechskantschlüssel
S20R PDUNR/L 11	●	●	20	18.3	200	13	≥25	DNM. 1104..	APL-01	ALV-01-M6x14 ALV-02-M6x17	AADN-SD317	AAY-01	-	-	AAL-02-2.5
S25S PDUNR/L 11	●	●	25	23	250	17	≥32								
S25S PDUNR/L 15	●	●	25	23	250	19	≥32								
S32T PDUNR/L 15	●	●	32	30	300	22	≥40	DNM. 1506..	APL-03	ALV-03-M8x19	AADN-3-0001	AAY-02	-	-	AAL-03-3
S40U PDUNR/L 15	●	●	40	37.5	350	27	≥50								
S50V PDUNR/L 15	●	●	50	47	400	35	≥63								
A20P PDUNR/L 11	●	●	20	18.3	170	13	≥25	DNM. 1104..	APL-01	ALV-01-M6x14 ALV-02-M6x17	AADN-SD317	AAY-01	-	-	AAL-02-2.5
A25R PDUNR/L 11	●	●	25	23	200	17	≥32								
A32S PDUNR/L 11	●	●	32	30	250	22	≥40								
A32S PDUNR/L 15	●	●	32	30	250	22	≥40	DNM. 1506..	APL-03	ALV-03-M8x19	AADN-3-0001	AAY-02	-	-	AAL-03-3
A40T PDUNR/L 15	●	●	40	37.5	300	27	≥50								
A50U PDUNR/L 15	●	●	50	47	350	35	≥63								

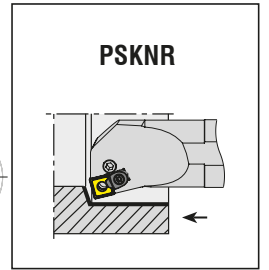
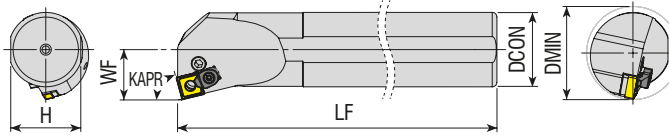

Takım Kodu Ordering Code Bestell-Bezeichnung	Stok Stock Lager		Takım Ölçüleri (mm) Dimension (mm) Abmessung (mm)					Kesici Uç Insert Wendeschneidplatte	Yedek Parçaları / Spare Parts / Ersatzteile						
	R	L	DCON	H	LF	WF	DMIN		Levyé Lever Kniehebel	Levyé Vidası Lever Screw Kniehebelschraube	Altılık Shim Unterlage	Altılık Yayı Shim Spring Feder für Unterlage	Baskı Pabucu Wedge Clamp Spannpratze	Pabuç Vidası Clamp Screw Klemmschraube	Anahtar Allen Key Innensechskantschlüssel
S25S PSKNR/L 12C	●	●	25	23	250	17	≥32	SNM. 1204..	APL-02	ALV-08-M8x16 ALV-03-M8x19	AASN-3-0004	AAY-02	ACK-05	4015-M4x11	AAL-03-3
S32T PSKNR/L 12C	●	●	32	30	300	22	≥40								
S40U PSKNR/L 12C	●	●	40	37.5	350	27	≥50								
S50V PSKNR/L 12C	●	●	50	47	400	35	≥63	SNM. 1506..	APL-04	ALV-04-M8x22	AASN-3-0023	AAY-03	-	-	
S32T PSKNR/L 15	○	○	32	30	300	22	≥40								
S40U PSKNR/L 15	○	○	40	37.5	350	27	≥50								
S50V PSKNR/L 15	○	○	50	47	400	35	≥63								

R: Sağ / Right / Rechts L: Sol/Left/Links
● Stokta / In Stock / Auf Lager ○ Stokta Yok / Non Stock Item / Kein Lagerartikel, Lieferzeit auf Anfrage

Sipariş Örneği/Ordering Example/Bestellbeispiel
1 ad./pcs./stück S20R PDUNR 11

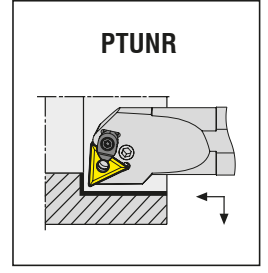
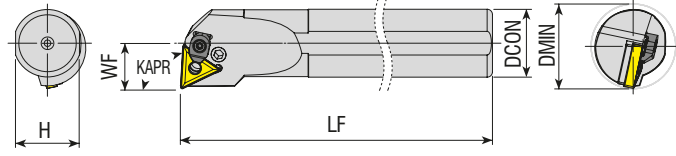

Takım Kodu Ordering Code Bestell-Bezeichnung	Stok Stock Lager		Takım Ölçüleri (mm) Dimension (mm) Abmessung (mm)				Kesici Uç Insert Wendeschneidplatte	Yedek Parçaları / Spare Parts / Ersatzteile							
	R	L	DCON	H	LF	WF		DMIN	Levyeye Lever Kniehebel	Levyeye Vidası Lever Screw Kniehebelschraube	Altılık Shim Unterlage	Altılık Yayını Shim Spring Feder für Unterlage	Baskı Pabuçunu Wedge Clamp Spannpratze	Pabuç Vidası Clamp Screw Klemmschraube	Anahtar Allen Key Inmenschlüssel
S16P PTUNR/L 16	●	●	16	14.8	170	11	≥20	TNM. 1604..	APL-08	ALV-07-M6x13	-	AAY-07	-	-	AAL-02-2.5
S20R PTUNR/L 16	●	●	20	18.3	200	13	≥25		APL-01	ALV-01-M6x14	AATN-3-0025	AAY-01			
S25S PTUNR/L 16C	●	●	25	23	250	17	≥32			ALV-02-M6x17					
S32T PTUNR/L 16C	●	●	32	30	300	22	≥40		APL-02		ALV-03-M8x19	AATN-3-0015	AAY-02	ACK-05	
S40U PTUNR/L 16C	●	●	40	37.5	350	27	≥50			TNM. 2204..					
S32T PTUNR/L 22C	●	●	32	30	300	22	≥40	APL-02	ALV-03-M8x19		AATN-3-0015	AAY-02	ACK-05	4015-M4x11	
S40U PTUNR/L 22C	●	●	40	37.5	350	27	≥50			TNM. 2204..					ALV-03-M8x19
S50V PTUNR/L 22C	●	●	50	47	400	35	≥63								

R: Sağ / Right / Rechts L: Sol/Left/Links

● Stokta / In Stock / Auf Lager ○ Stokta Yok / Non Stock Item / Kein Lagerartikel, Lieferzeit auf Anfrage

Sipariş Örneği/Ordering Example/Bestellbeispiel

1 ad./pcs./stück S16P PTUNR 16



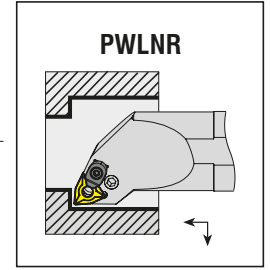
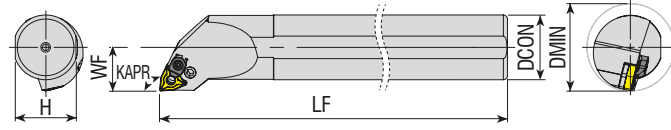

Takım Kodu Ordering Code Bestell-Bezeichnung	Stok Stock Lager		Takım Ölçüleri (mm) Dimension (mm) Abmessung (mm)					Kesici Uç Insert Wendeschneidplatte	Yedek Parçaları / Spare Parts / Ersatzteile						
	R	L	DCON	H	LF	WF	DMIN		Levyé Lever Kniehebel	Levyé Vidası Lever Screw Kniehebelschraube	Altık Shim Unterlage	Altık Yay Shim Spring Feder für Unterlage	Baskı Pabucu Wedge Clamp Spannpratze	Pabuç Vidası Clamp Screw Klemmschraube	Anahtar Allen Key Innensechskantschlüssel
S20R PWLNR/L 06	●	●	20	18.3	200	13	≥25	WNM. 0604..	APL-01	ALV-01-M6x14 ALV-02-M6x17	AAWN-SW317	AAY-01	-	-	AAL-02-2.5
S25S PWLNR/L 06	●	●	25	23	250	17	≥32								
S32T PWLNR/L 06	●	●	32	30	300	22	≥40								
S25S PWLNR/L 08C	●	●	25	23	250	17	≥32	WNM. 0804..	APL-02	ALV-03-M8x19	AAWN-3-0001	AAY-02	ACK-05	4015-M4x11	AAL-03-3
S32T PWLNR/L 08C	●	●	32	30	300	22	≥40								
S40U PWLNR/L 08C	●	●	40	37.5	350	27	≥50								
S50V PWLNR/L 08C	●	●	50	47	400	35	≥63	WNM. 0604..	APL-01	ALV-01-M6x14 ALV-02-M6x17	AAWN-SW317	AAY-01	-	-	AAL-02-2.5
A20P PWLNR/L 06	●	●	20	18.3	170	13	≥25								
A25R PWLNR/L 06	●	●	25	23	200	17	≥32								
A32S PWLNR/L 06	●	●	32	30	250	22	≥40	WNM. 0804..	APL-02	ALV-03-M8x19	AAWN-3-0001	AAY-02	ACK-05	4015-M4x11	AAL-03-3
A25R PWLNR/L 08C	●	●	25	23	200	17	≥32								
A32S PWLNR/L 08C	●	●	32	30	250	22	≥40								
A40T PWLNR/L 08C	●	●	40	37.5	300	27	≥50	WNM. 0804..	APL-02	ALV-03-M8x19	AAWN-3-0001	AAY-02	ACK-05	4015-M4x11	AAL-03-3
A50U PWLNR/L 08C	●	●	50	47	350	35	≥63								

R: Sağ / Right / Rechts L: Sol/Left/Links

● Stokta / In Stock / Auf Lager ○ Stokta Yok / Non Stock Item / Kein Lagerartikel, Lieferzeit auf Anfrage

Sipariş Örneği/Ordering Example/Bestellbeispiel

1 ad./pcs./stück S20R PWLNR 06





*konusulan
the spoken kalite...
quality...*

S-SİSTEM

S-SİSTEM DELİK TORNA KATERLERİ
S-SYSTEM BORING BARS
S-SYSTEM BOHRSTANGE



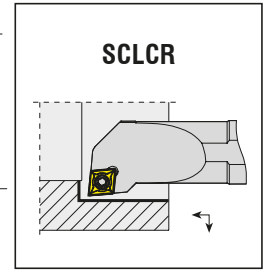
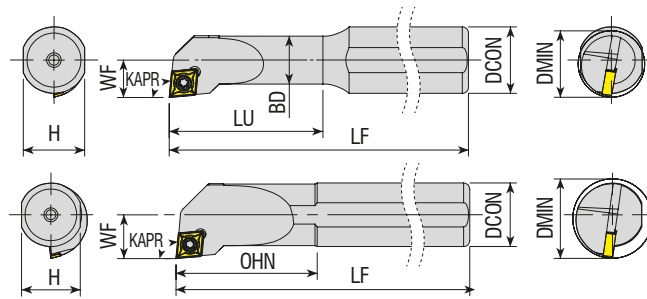

Takım Kodu
Ordering Code
Bestell-Bezeichnung

Stok Stock Lager	Takım Ölçüleri (mm) Dimension (mm) Abmessung (mm)								Kesici Uç Insert Wendeschneidplatte	Yedek Parçaları / Spare Parts / Ersatzteile					
	R	L	DCON	BD	H	LU=OHN	LF	WF		DMIN	Sıkma Vidası Screw Schraube	Altlık Shim Unterlage	Altlık Vidası Shim Screw Schraube für Unterlage	Tork Anahtar Torx Key Torx-Schlüssel	
	●	○	08	5	7.3	18	100	3	≥6	CC.T 030102	4006-M1.6x3.2			80-T06	
S0608H SCLCR/L 06	●	●	08	6	7.3	25	100	4.5	≥8		4008-M2.5x4.5				
S08H SCLCR/L 06	●	●	08	8	7.3	20	100	06	≥11						
S10K SCLCR/L 06	●	●	10	10	09	25	125	07	≥13		CC.T 0602..	4008-M2.5x6	-	-	80-T08
S12K SCLCR/L 06	●	●	12	12	11	25	125	09	≥16						
S1216P SCLCR/L 06	●	●	16	11.5	14.8	37	170	09	≥16						
S16P SCLCR/L 06	●	●	16	16	14.8	35	170	11	≥20						
S12K SCLCR/L 09	●	●	12	12	11	30	125	09	≥16	CC.T 09T3..	4015-M3.5x8				
S1416P SCLCR/L 09	●	●	16	14	14.8	45	170	9.5	≥17						
S16P SCLCR/L 09	●	●	16	16	14.8	35	170	11	≥20						
S1620R SCLCR/L 09	●	●	20	16	18.3	50	200	11	≥20	CC.T 09T3..	4015-M3.5x9	-	-	80-T15	
S20R SCLCR/L 09	●	●	20	20	18.3	40	200	13	≥25						
S25S SCLCR/L 09	●	●	25	25	23	50	250	17	≥32						
S32T SCLCR/L 09	●	●	32	32	30	60	300	22	≥40		4015-M3.5x12	AACN-2-0001	AAV-08-M3.5x8		
S25S SCLCR/L 12	●	●	25	25	23	50	250	17	≥32	CC.T 1204..	4020-M4.5x12	AACN-2-0003	AAV-10-M4.5x8	80-T20	
S32T SCLCR/L 12	●	●	32	32	30	60	300	22	≥40		1020-M4.5x16		AAV-07-M4.5x13		
S40U SCLCR/L 12	●	●	40	40	37.5	70	350	27	≥50						
A08H SCLCR/L 06	●	●	08	8	7.3	20	100	06	≥11	CC.T 0602..	4008-M2.5x6	-	-	80-T08	
A10H SCLCR/L 06	●	●	10	10	09	25	100	07	≥13						
A12H SCLCR/L 06	●	●	12	12	11	25	100	09	≥16						
A16M SCLCR/L 09	●	●	16	16	14.8	35	150	11	≥20	CC.T 09T3..	4015-M3.5x9	-	-	80-T15	
A20P SCLCR/L 09	●	●	20	20	18.3	40	170	13	≥25						
A25R SCLCR/L 09	●	●	25	25	23	50	200	17	≥32						
A32S SCLCR/L 09	●	●	32	32	30	60	250	22	≥40		4015-M3.5x12	AACN-2-0001	AAV-08-M3.5x8		
A25R SCLCR/L 12	●	●	25	25	23	50	200	17	≥32	CC.T 1204..	4020-M4.5x12	AACN-2-0003	AAV-10-M4.5x8	80-T20	

R: Sağ / Right / Rechts L: Sol/Left/Links

● Stokta / In Stock / Auf Lager ○ Stokta Yok / Non Stock Item / Kein Lagerartikel, Lieferzeit auf Anfrage

Sipariş Örneği/Ordering Example/Bestellbeispiel
1 ad./pcs./stück S0608H SCLCR 03

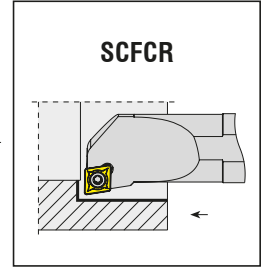
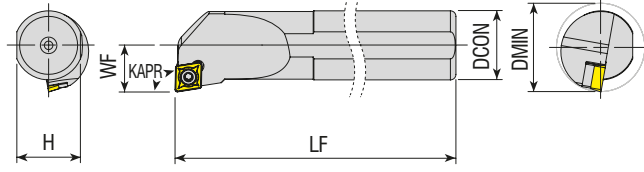
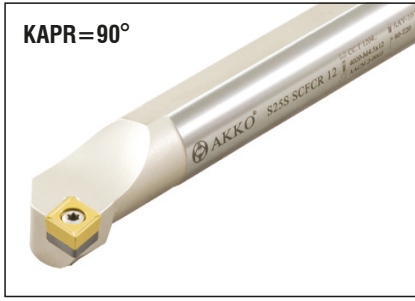

Takım Kodu
Ordering Code
Bestell-Bezeichnung

Stok Stock Lager	Takım Ölçüleri (mm) Dimension (mm) Abmessung (mm)						Kesici Uç Insert Wendeschneidplatte	Yedek Parçaları / Spare Parts / Ersatzteile					
	R	L	DCON	H	LF	WF		DMIN	Sıkma Vidası Screw Schraube	Altlık Shim Unterlage	Altlık Vidası Shim Screw Schraube für Unterlage	Tork Anahtar Torx Key Torx-Schlüssel	
	●	●											
S08H SCFCR/L 06	●	●	08	7.3	100	06	≥11	CC.T 0602..	4008-M2.5x6	-	-	80-T08	
S10K SCFCR/L 06	●	●	10	09	125	07	≥13						
S12K SCFCR/L 06	●	●	12	11	125	09	≥16	CC.T 09T3..	4015-M3.5x8	-	-	80-T15	
S12K SCFCR/L 09	●	●	12	11	125	09	≥16						
S16P SCFCR/L 09	●	●	16	14.8	170	11	≥20						
S20R SCFCR/L 09	●	●	20	18.3	200	13	≥25	4015-M3.5x12	AACN-2-0001	AAV-08-M3.5x8	80-T20		
S25S SCFCR/L 09	●	●	25	23	250	17	≥32						
S25S SCFCR/L 12	●	○	25	23	250	17	≥32	4020-M4.5x12	AACN-2-0003	AAV-10-M4.5x8	80-T20		
S32T SCFCR/L 12	○	○	32	30	300	22	≥40						
S40U SCFCR/L 12	○	○	40	37.5	350	27	≥50		1020-M4.5x16			AAV-07-M4.5x13	

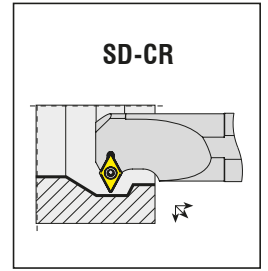
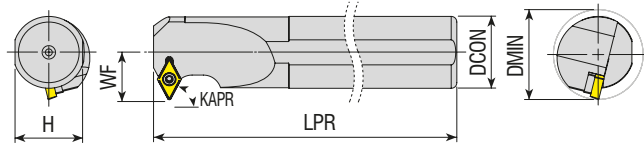

Takım Kodu
Ordering Code
Bestell-Bezeichnung

Stok Stock Lager	Takım Ölçüleri (mm) Dimension (mm) Abmessung (mm)						Kesici Uç Insert Wendeschneidplatte	Yedek Parçaları / Spare Parts / Ersatzteile				
	R	L	DCON	H	LPR	WF		DMIN	Sıkma Vidası Screw Schraube	Altlık Shim Unterlage	Altlık Vidası Shim Screw Schraube für Unterlage	Tork Anahtar Torx Key Torx-Schlüssel
	●	●										
S10K SD-CR/L 07	●	●	10	9	125	07	≥14	DC.T 0702..	4008-M2.5x6	-	-	80-T08
S12K SD-CR/L 07	●	●	12	11	125	09	≥16					
S16P SD-CR/L 07	●	●	16	14.8	170	11	≥20	DC.T 11T3..	4015-M3.5x11	-	-	80-T15
S20R SD-CR/L 07	●	○	20	18.3	200	13	≥25					
S16P SD-CR/L 11	●	●	16	14.8	170	14	≥22					
S20R SD-CR/L 11	●	●	20	18.3	200	15	≥25	4015-M3.5x14	AADN-2-0001	AAV-06-M3.5x11	80-T15	
S25S SD-CR/L 11	●	●	25	23	250	18	≥32					
S32T SD-CR/L 11	●	●	32	30	300	22	≥40					
S40U SD-CR/L 11	●	●	40	37.5	350	27	≥50					

R: Sağ / Right / Rechts L: Sol/Left/Links
● Stokta / In Stock / Auf Lager ○ Stokta Yok / Non Stock Item / Kein Lagerartikel, Lieferzeit auf Anfrage

Sipariş Örneği/Ordering Example/Bestellbeispiel
1 ad./pcs./stück S08H SCFCR 06

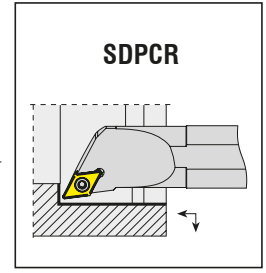
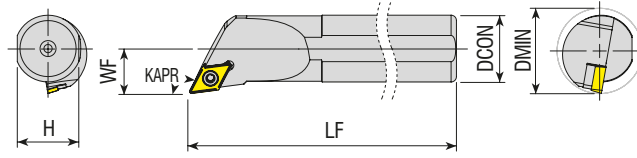

Takım Kodu
Ordering Code
Bestell-Bezeichnung

Stok Stock Lager	Takım Ölçüleri (mm) Dimension (mm) Abmessung (mm)						Kesici Uç Insert Wendeschneidplatte	Yedek Parçaları / Spare Parts / Ersatzteile				
	R	L	DCON	H	LF	WF		DMIN	Sıkma Vidası Screw Schraube	Altık Shim Unterlage	Altık Vidası Shim Screw Schraube für Unterlage	Tork Anahtar Torx Key Torx-Schlüssel
S10K SDPCR/L 07	●	●	10	09	125	07	≥13	DC.T 0702..	4008-M2.5x6	-	-	80-T08
S12K SDPCR/L 07	●	●	12	11	125	09	≥16					
S16P SDPCR/L 11	●	●	16	14.8	170	11	≥20	DC.T 11T3..	4015-M3.5x9	-	-	80-T15
S20R SDPCR/L 11	●	●	20	18.3	200	13	≥25		4015-M3.5x11			
S25S SDPCR/L 11	●	●	25	23	250	17	≥32		4015-M3.5x12			

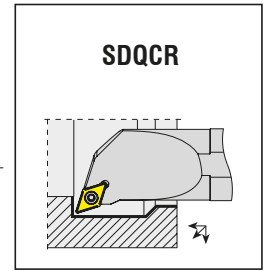
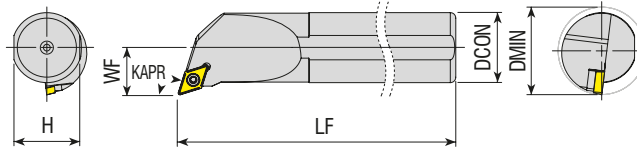

Takım Kodu
Ordering Code
Bestell-Bezeichnung

Stok Stock Lager	Takım Ölçüleri (mm) Dimension (mm) Abmessung (mm)						Kesici Uç Insert Wendeschneidplatte	Yedek Parçaları / Spare Parts / Ersatzteile					
	R	L	DCON	H	LF	WF		DMIN	Sıkma Vidası Screw Schraube	Altık Shim Unterlage	Altık Vidası Shim Screw Schraube für Unterlage	Tork Anahtar Torx Key Torx-Schlüssel	
S10K SDQCR/L 07	●	●	10	09	125	07	≥13	DC.T 0702..	4008-M2.5x6	-	-	80-T08	
S12K SDQCR/L 07	●	●	12	11	125	09	≥16						
S16P SDQCR/L 07	●	●	16	14.8	170	11	≥20	DC.T 11T3..	4015-M3.5x9	-	-	80-T15	
S20R SDQCR/L 07	●	●	20	18.3	200	13	≥25		4015-M3.5x11				
S16P SDQCR/L 11	●	●	16	14.8	170	11	≥20		4015-M3.5x12				AADN-2-0001
S20R SDQCR/L 11	●	●	20	18.3	200	13	≥25	4015-M3.5x14	AADN-2-0001	AAV-06-M3.5x11			
S25S SDQCR/L 11	●	●	25	23	250	17	≥32	DC.T 11T3..	4015-M3.5x9	-	-	80-T15	
S32T SDQCR/L 11	●	●	32	30	300	22	≥40						4015-M3.5x11
S40U SDQCR/L 11	●	●	40	37.5	350	27	≥50	4015-M3.5x12	AADN-2-0001	AAV-08-M3.5x8			
A10H SDQCR/L 07	●	●	10	09	100	07	≥13	DC.T 0702..	4008-M2.5x6	-	-	80-T08	
A12H SDQCR/L 07	●	●	12	11	100	09	≥16						
A16M SDQCR/L 07	●	●	16	14.8	150	11	≥20	DC.T 11T3..	4015-M3.5x9	-	-	80-T15	
A20P SDQCR/L 07	●	●	20	18.3	170	13	≥25						4015-M3.5x11
A16M SDQCR/L 11	●	●	16	14.8	150	11	≥20						4015-M3.5x12
A20P SDQCR/L 11	●	●	20	18.3	170	13	≥25	4015-M3.5x14	AADN-2-0001	AAV-06-M3.5x11			
A25R SDQCR/L 11	●	●	25	23	200	17	≥32	DC.T 11T3..	4015-M3.5x9	-	-	80-T15	
A32S SDQCR/L 11	●	●	32	30	250	22	≥40						4015-M3.5x11
								4015-M3.5x12	AADN-2-0001	AAV-08-M3.5x8			
								4015-M3.5x14	AADN-2-0001	AAV-06-M3.5x11			

R: Sağ / Right / Rechts L: Sol/Left/Links

● Stokta / In Stock / Auf Lager ○ Stokta Yok / Non Stock Item / Kein Lagerartikel, Lieferzeit auf Anfrage

Sipariş Örneği/Ordering Example/Bestellbeispiel

1 ad./pcs./stück S10K SDPCR 07

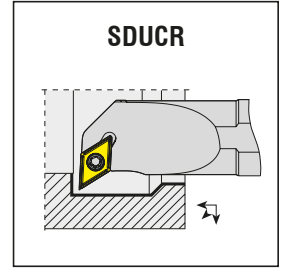
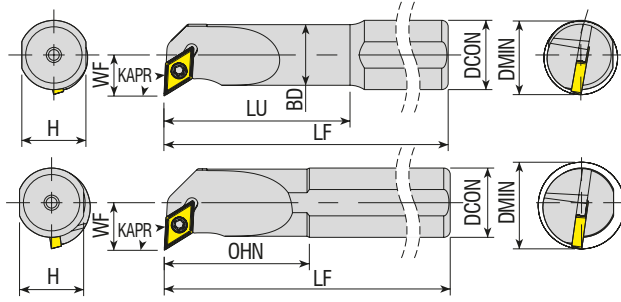

Takım Kodu Ordering Code Bestell-Bezeichnung	Stok Stock Lager		Takım Ölçüleri (mm) Dimension (mm) Abmessung (mm)							Kesici Uç Insert Wendeschneidplatte	Yedek Parçaları / Spare Parts / Ersatzteile			
	R	L	DCON	BD	H	LU=OHN	LF	WF	DMIN		Sıkma Vidası Screw Schraube	Altlık Shim Unterlage	Altlık Vidası Shim Screw Schraube für Unterlage	Tork Anahtar Torx Key Torx-Schlüssel
S0810K SDUCR/L 07	●	●	10	8	09	30	125	08	≥13	DC.T 0702..	4008-M2.5x6	-	-	80-T08
S10K SDUCR/L 07	●	●	10	10	09	25	125	08	≥13					
S12K SDUCR/L 07	●	●	12	12	11	25	125	09	≥16					
S1216P SDUCR/L 07	●	●	16	11.5	14.8	37	170	09	≥16					
S1416P SDUCR/L 07	●	●	16	14	14.8	45	170	9.5	≥17					
S16P SDUCR/L 07	●	●	16	16	14.8	35	170	11	≥20					
S20R SDUCR/L 07	●	●	20	20	18.3	40	200	13	≥25					
S1416P SDUCR/L 11	●	●	16	14	14.8	45	170	11	≥18	DC.T 11T3..	4015-M3.5x9	-	-	80-T15
S16P SDUCR/L 11	●	●	16	16	14.8	35	170	11	≥20					
S1620R SDUCR/L 11	●	●	20	16	18.3	50	200	11	≥20					
S20R SDUCR/L 11	●	●	20	20	18.3	40	200	13	≥25					
S25S SDUCR/L 11	●	●	25	25	23	50	250	17	≥32					
S32T SDUCR/L 11	●	●	32	32	30	60	300	22	≥40					
S40U SDUCR/L 11	●	●	40	40	37.5	70	350	27	≥50					
S50V SDUCR/L 11	●	●	50	50	47	80	400	35	≥63					
A0810H SDUCR/L 07	●	●	10	8	09	30	100	08	≥13	DC.T 0702..	4008-M2.5x6	-	-	80-T08
A10H SDUCR/L 07	●	●	10	10	09	25	100	08	≥13					
A12H SDUCR/L 07	●	●	12	12	11	25	100	09	≥16					
A16M SDUCR/L 07	●	●	16	16	14.8	35	150	11	≥20					
A20P SDUCR/L 07	●	●	20	20	18.3	40	170	13	≥25					
A16M SDUCR/L 11	●	●	16	16	14.8	35	150	11	≥20	DC.T 11T3..	4015-M3.5x9	-	-	80-T15
A20P SDUCR/L 11	●	●	20	20	18.3	40	170	13	≥25					
A25R SDUCR/L 11	●	●	25	25	23	50	200	17	≥32					
A32S SDUCR/L 11	●	●	32	32	30	60	250	22	≥40					

R: Sağ / Right / Rechts L: Sol/Left/Links

● Stokta / In Stock / Auf Lager ○ Stokta Yok / Non Stock Item / Kein Lagerartikel, Lieferzeit auf Anfrage

Sipariş Örneği/Ordering Example/Bestellbeispiel
1 ad./pcs./stück S0810K SDUCR 07



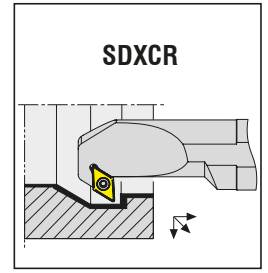
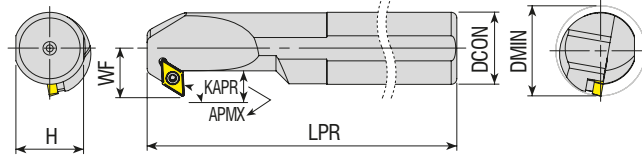

Takım Kodu Ordering Code Bestell-Bezeichnung	Stok Stock Lager		Takım Ölçüleri (mm) Dimension (mm) Abmessung (mm)					Kesici Uç Insert Wendeschneidplatte	Yedek Parçaları / Spare Parts / Ersatzteile				
	R	L	DCON	H	LPR	WF	APMX		DMIN	Sıkma Vidası Screw Schraube	Altık Shim Unterlage	Altık Vidası Shim Screw Schraube für Unterlage	Tork Anahtar Torx Key Torx-Schlüssel
S12K SDXCR/L 07	●	●	12	11	125	09	4.5	≥16	DC.T 0702..	4008-M2.5x6	-	-	80-T08
S16P SDXCR/L 07	●	●	16	14.8	170	11	6.5	≥20					
S20R SDXCR/L 07	●	●	20	18.3	200	13	6.5	≥25					
S16P SDXCR/L 11	●	●	16	14.8	170	11	7.5	≥20	DC.T 11T3..	4015-M3.5x11	-	-	80-T15
S20R SDXCR/L 11	●	●	20	18.3	200	14	7.5	≥25					
S25S SDXCR/L 11	●	●	25	23	250	17	9	≥32					
S32T SDXCR/L 11	●	●	32	30	300	22	12.5	≥40					
S40U SDXCR/L 11	●	●	40	37.5	350	27	14.5	≥50	4015-M3.5x14	AADN-2-0001	AAV-08-M3.5x8 AAV-06-M3.5x11		

Not: "APMX" ölçüleri R0.4'e göre verilmiştir.
Note: Dimensions of "APMX" are given according to R.04.
Hinweis: Das Maß "APMX" bezieht sich auf R 0,4

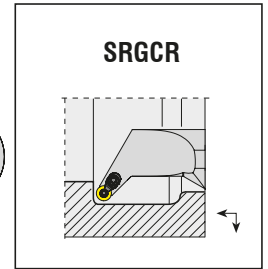
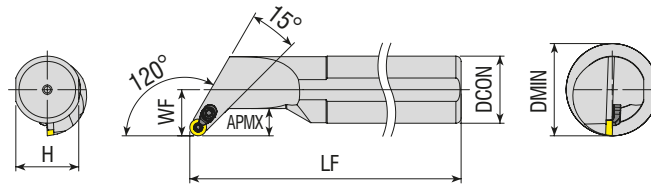

Takım Kodu Ordering Code Bestell-Bezeichnung	Stok Stock Lager		Takım Ölçüleri (mm) Dimension (mm) Abmessung (mm)					Kesici Uç Insert Wendeschneidplatte	Yedek Parçaları / Spare Parts / Ersatzteile					
	R	L	DCON	H	LF	WF	APMX		DMIN	Sıkma Vidası Screw Schraube	Altık Shim Unterlage	Altık Vidası Shim Screw Schraube für Unterlage	Baskı Pabucu Shim Screw Spann Pratze	Pabuç Vidası Shim Screw Klemmschraube
S16P SRGCR/L 08	●	○	16	14.8	170	11	7	≥22	RCM. 0803..	3008-M3x8	-	-	-	-
S20R SRGCR/L 08	●	●	20	18.3	200	13	7	≥26						
S25S SRGCR/L 08C	●	●	25	23	250	17	9.5	≥34						
S32T SRGCR/L 08C	●	○	32	30	300	22	13	≥44						
S40U SRGCR/L 08C	●	○	40	37.5	350	27	15	≥54						
											ACK-15	4015-M3.5x11	80-T08	

R: Sağ / Right / Rechts L: Sol/Left/Links

● Stokta / In Stock / Auf Lager ○ Stokta Yok / Non Stock Item / Kein Lagerartikel, Lieferzeit auf Anfrage

Sipariş Örneği/Ordering Example/Bestellbeispiel

1 ad./pcs./stück S12K SDXCR 07

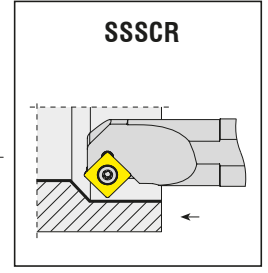
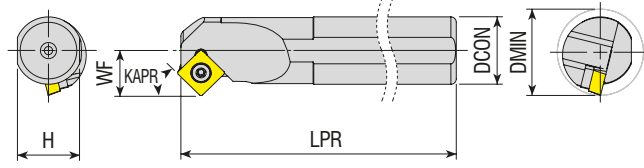

Takım Kodu Ordering Code Bestell-Bezeichnung	Stok Stock Lager		Takım Ölçüleri (mm) Dimension (mm) Abmessung (mm)					Kesici Uç Insert Wendeschneidplatte	Yedek Parçaları / Spare Parts / Ersatzteile			
	R	L	DCON	H	LPR	WF	DMIN		Sıkma Vidası Screw Schraube	Altlık Shim Unterlage	Altlık Vidası Shim Screw Schraube für Unterlage	Tork Anahtar Torx Key Torx-Schlüssel
S16P SSSCR/L 09	●	●	16	14.8	170	11	≥20	SC.T 09T3..	4015-M3.5x9	-	-	80-T15
S20R SSSCR/L 09	●	●	20	18.3	200	13	≥25		4015-M3.5x11	-	-	
S25S SSSCR/L 09	●	●	25	23	250	17	≥32		4015-M3.5x12	AASN-2-0001	AAV-08-M3.5x8	
S25S SSSCR/L 12	●	●	25	23	250	17	≥32	SC.T 1204..	4020-M4.5x12	AASN-2-0004	AAV-10-M4.5x8	80-T20
S32T SSSCR/L 12	●	○	32	30	300	22	≥40		1020-M4.5x16		AAV-07-M4.5x13	
S40U SSSCR/L 12	●	○	40	37.5	350	27	≥50					

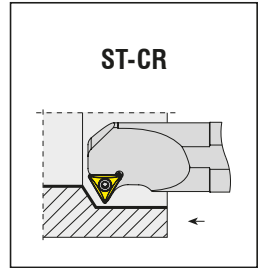
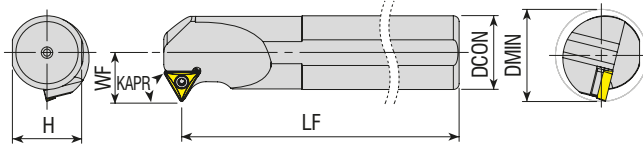

Takım Kodu Ordering Code Bestell-Bezeichnung	Stok Stock Lager		Takım Ölçüleri (mm) Dimension (mm) Abmessung (mm)					Kesici Uç Insert Wendeschneidplatte	Yedek Parçaları / Spare Parts / Ersatzteile			
	R	L	DCON	H	LF	WF	DMIN		Sıkma Vidası Screw Schraube	Altlık Shim Unterlage	Altlık Vidası Shim Screw Schraube für Unterlage	Tork Anahtar Torx Key Torx-Schlüssel
S16P SSSCR/L 09	●	●	16	14.8	170	11	≥20	TC.T 1102..	4008-M2.5x6	-	-	80-T08
S20R SSSCR/L 09	●	●	20	18.3	200	13	≥25					
S25S SSSCR/L 09	●	●	25	23	250	17	≥32					
S25S SSSCR/L 12	●	●	25	23	250	17	≥32	TC.T 16T3..	4015-M3.5x9	AATN-2-0001	-	80-T15
S32T SSSCR/L 12	●	○	32	30	300	22	≥40		4015-M3.5x11			
S40U SSSCR/L 12	●	○	40	37.5	350	27	≥50		4015-M3.5x14		AAV-08-M3.5x8 AAV-06-M3.5x11	

R: Sağ / Right / Rechts L: Sol/Left/Links

● Stokta / In Stock / Auf Lager ○ Stokta Yok / Non Stock Item / Kein Lagerartikel, Lieferzeit auf Anfrage

Sipariş Örneği/Ordering Example/Bestellbeispiel

1 ad./pcs./stück S16P SSSCR 09

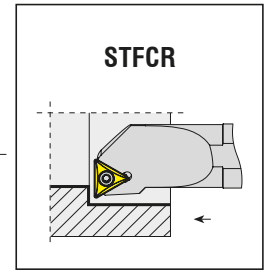
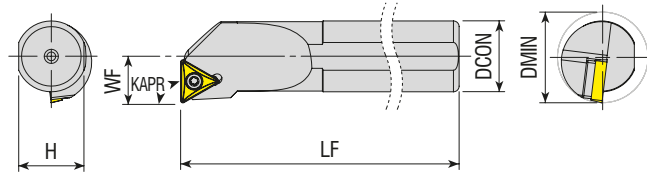

Takım Kodu Ordering Code Bestell-Bezeichnung	Stok Stock Lager		Takım Ölçüleri (mm) Dimension (mm) Abmessung (mm)					Kesici Uç Insert Wendeschneidplatte	Yedek Parçaları / Spare Parts / Ersatzteile			
	R	L	DCON	H	LF	WF	DMIN		Sıkma Vidası Screw Schraube	Altlık Shim Unterlage	Altlık Vidası Shim Screw Schraube für Unterlage	Tork Anahtar Torx Key Torx-Schlüssel
S0610F STFCR/L 06	●	●	10	09	80	4.5	≥08	TC.T 06T1..	3006-M2x4			80-T06
S08H STFCR/L 06	●	●	08	7.3	100	06	≥11					
S10K STFCR/L 09	●	●	10	09	125	07	≥13	TC.T 0902..	3007-M2.2x5	-	-	80-T07
S12K STFCR/L 09	●	●	12	11	125	09	≥17					
S12K STFCR/L 11	●	●	12	11	125	09	≥17	TC.T 1102..	4008-M2.5x6			80-T08
S16P STFCR/L 11	●	●	16	14.8	170	11	≥20					
S20R STFCR/L 11	●	●	20	18.3	200	13	≥25	TC.T 16T3..	4015-M3.5x9 4015-M3.5x11	-	-	80-T15
S16P STFCR/L 16	●	●	16	14.8	170	11	≥20					
S20R STFCR/L 16	●	●	20	18.3	200	13	≥25					
S25S STFCR/L 16	●	●	25	23	250	17	≥32					
S32T STFCR/L 16	●	●	32	30	300	22	≥40	4015-M3.5x14	AATN-2-0001	AAV-08-M3.5x8 AAV-06-M3.5x11		
S40U STFCR/L 16	●	○	40	37.5	350	27	≥50					

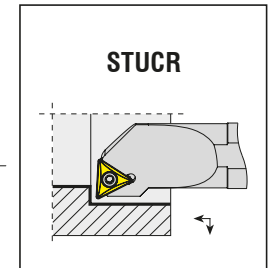
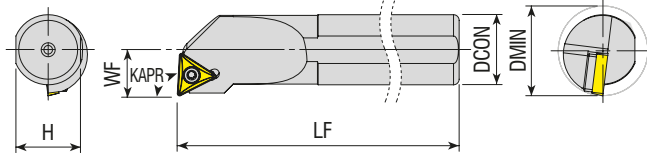

Takım Kodu Ordering Code Bestell-Bezeichnung	Stok Stock Lager		Takım Ölçüleri (mm) Dimension (mm) Abmessung (mm)					Kesici Uç Insert Wendeschneidplatte	Yedek Parçaları / Spare Parts / Ersatzteile			
	R	L	DCON	H	LF	WF	DMIN		Sıkma Vidası Screw Schraube	Altlık Shim Unterlage	Altlık Vidası Shim Screw Schraube für Unterlage	Tork Anahtar Torx Key Torx-Schlüssel
S10K STUCR/L 09	●	●	10	09	125	07	≥13	TC.T 0902..	3007-M2.2x5			80-T07
S12K STUCR/L 09	●	●	12	11	125	09	≥16					
S12K STUCR/L 11	●	●	12	11	125	09	≥17	TC.T 1102..	4008-M2.5x6			80-T08
S16P STUCR/L 11	●	●	16	14.8	170	11	≥20					
S20R STUCR/L 11	●	●	20	18.3	200	13	≥25	TC.T 16T3..	4015-M3.5x9 4015-M3.5x11	-	-	80-T15
S16P STUCR/L 16	●	●	16	14.8	170	11	≥20					
S20R STUCR/L 16	●	●	20	18.3	200	13	≥25					
S25S STUCR/L 16	●	●	25	23	250	17	≥32					
S32T STUCR/L 16	●	●	32	30	300	22	≥40	4015-M3.5x14	AATN-2-0001	AAV-08-M3.5x8 AAV-06-M3.5x11		
S40U STUCR/L 16	●	●	40	37.5	350	27	≥50					

R: Sağ / Right / Rechts L: Sol/Left/Links

● Stokta / In Stock / Auf Lager ○ Stokta Yok / Non Stock Item / Kein Lagerartikel, Lieferzeit auf Anfrage

Sipariş Örneği/Ordering Example/Bestellbeispiel

1 ad./pcs./stück S0610F STFCR 06

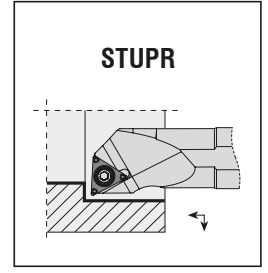
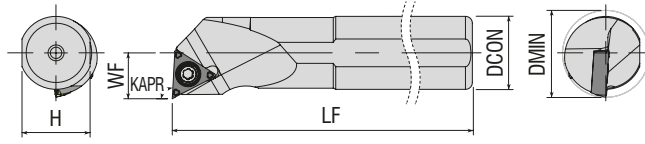

STUPR

Takım Kodu Ordering Code Bestell-Bezeichnung	Stok Stock Lager		Takım Ölçüleri (mm) Dimension (mm) Abmessung (mm)				Kesici Uç Insert Wendeschneidplatte	Yedek Parçaları / Spare Parts / Ersatzteile				
	R	L	DCON	H	LF	WF		DMIN	Sıkma Vidası Screw Schraube	Altlık Shim Unterlage	Altlık Vidası Shim Screw Schraube für Unterlage	Tork Anahtar Torx Key Torx-Schlüssel
S08H STUPR/L 0802	●	○	08	7.3	100	05	≥10	TP. 0802..	3006-M2x4			80-T06
S10K STUPR/L 1103	●	○	10	09	125	06	≥12	TP. 1103..	4010-M3x6	-	-	80-T10
S12K STUPR/L 1103	●	●	12	11	125	09	≥16					
S12M STUPR/L 1103	●	●	12	11	150	08	≥16					
S16P STUPR/L 1103	●	●	16	14.8	170	10	≥20					
S16R STUPR/L 1103	●	●	16	14.8	200	10	≥20		4010-M3x8			

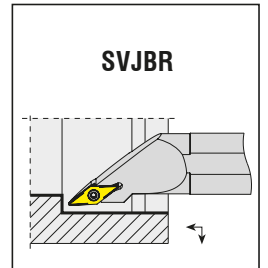
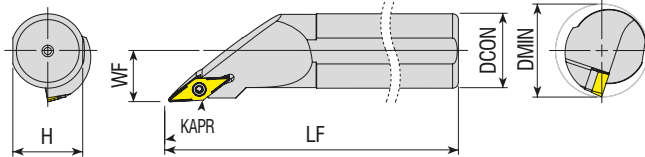

SVJBR

Takım Kodu Ordering Code Bestell-Bezeichnung	Stok Stock Lager		Takım Ölçüleri (mm) Dimension (mm) Abmessung (mm)				Kesici Uç Insert Wendeschneidplatte	Yedek Parçaları / Spare Parts / Ersatzteile				
	R	L	DCON	H	LF	WF		DMIN	Sıkma Vidası Screw Schraube	Altlık Shim Unterlage	Altlık Vidası Shim Screw Schraube für Unterlage	Tork Anahtar Torx Key Torx-Schlüssel
S25S SVJBR/L 16	●	●	25	23	250	17	≥32	VBM. 1604..	4015-M3.5x12	AAVN-2-0002	AAV-08-M3.5x8	80-T15
S32T SVJBR/L 16	●	●	32	30	300	22	≥40					
S40U SVJBR/L 16	●	●	40	37.5	350	27	≥50					

R: Sağ / Right / Rechts L: Sol/Left/Links
● Stokta / In Stock / Auf Lager ○ Stokta Yok / Non Stock Item / Kein Lagerartikel, Lieferzeit auf Anfrage

Sipariş Örneği/Ordering Example/Bestellbeispiel
1 ad./pcs./stück S08H STUPR 0802

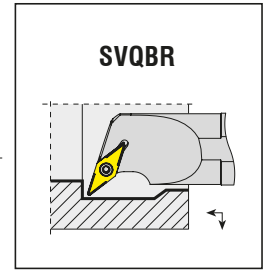
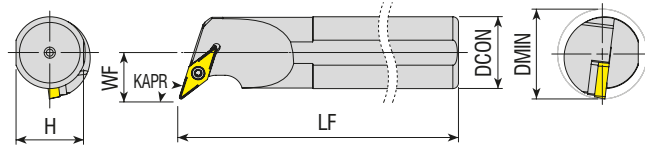

Takım Kodu Ordering Code Bestell-Bezeichnung	Stok Stock Lager		Takım Ölçüleri (mm) Dimension (mm) Abmessung (mm)				Kesici Uç Insert Wendeschneidplatte	Yedek Parçaları / Spare Parts / Ersatzteile				
	R	L	DCON	H	LF	WF		DMIN	Sıkma Vidası Screw Schraube	Altlık Shim Unterlage	Altlık Vidası Shim Screw Schraube für Unterlage	Tork Anahtar Torx Key Torx-Schlüssel
S16P SVQBR/L 11	●	●	16	14.8	170	11	≥20	VBM. 1103..	4008-M2.5x6	-	-	80-T08
S20R SVQBR/L 11	●	●	20	18.3	200	13	≥25	VBM. 1103..	4008-M2.5x6	-	-	80-T08
S25S SVQBR/L 16	●	●	25	23	250	17	≥32	VBM. 1604..	4015-M3.5x14	AAVN-2-0002	AAV-08-M3.5x8	80-T15
S32T SVQBR/L 16	●	●	32	30	300	22	≥40	VBM. 1604..	4015-M3.5x14	AAVN-2-0002	AAV-06-M3.5x11	80-T15
S40U SVQBR/L 16	●	●	40	37.5	350	27	≥50	VBM. 1604..	4015-M3.5x14	AAVN-2-0002	AAV-06-M3.5x11	80-T15
A20Q SVQBR/L 11	●	●	20	18.5	180	13	≥25	VBM. 1103..	4008-M2.5x6	-	-	80-T08
A20Q SVQBR/L 16	●	●	20	18.5	180	20	≥30	VBM. 1103..	4015-M3.5x11	-	-	80-T08
A25S SVQBR/L 16	●	●	25	23	250	17	≥32	VBM. 1604..	4015-M3.5x14	AAVN-2-0002	AAV-06-M3.5x11	80-T15
A32S SVQBR/L 16	●	●	32	30	250	22	≥40	VBM. 1604..	4015-M3.5x14	AAVN-2-0002	AAV-06-M3.5x11	80-T15

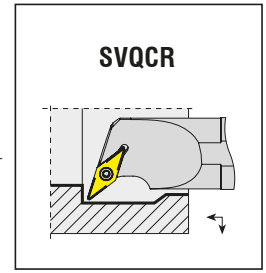
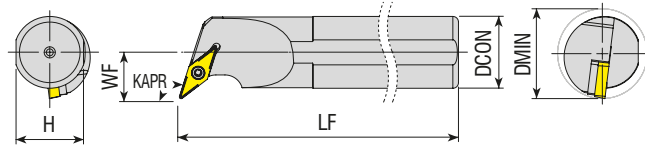

Takım Kodu Ordering Code Bestell-Bezeichnung	Stok Stock Lager		Takım Ölçüleri (mm) Dimension (mm) Abmessung (mm)				Kesici Uç Insert Wendeschneidplatte	Yedek Parçaları / Spare Parts / Ersatzteile				
	R	L	DCON	H	LF	WF		DMIN	Sıkma Vidası Screw Schraube	Altlık Shim Unterlage	Altlık Vidası Shim Screw Schraube für Unterlage	Tork Anahtar Torx Key Torx-Schlüssel
S16P SVQCR/L 11	●	●	16	14.8	170	11	≥20	VC.T 1103..	4008-M2.5x6	-	-	80-T08
S20R SVQCR/L 11	●	●	20	18.3	200	13	≥25	VC.T 1103..	4008-M2.5x6	-	-	80-T08
S25S SVQCR/L 16	●	●	25	23	250	17	≥32	VC.T 1604..	4015-M3.5x14	AAVN-2-0002	AAV-08-M3.5x8	80-T15
S32T SVQCR/L 16	●	●	32	30	300	22	≥40	VC.T 1604..	4015-M3.5x14	AAVN-2-0002	AAV-06-M3.5x11	80-T15
S40U SVQCR/L 16	●	●	40	37.5	350	27	≥50	VC.T 1604..	4015-M3.5x14	AAVN-2-0002	AAV-06-M3.5x11	80-T15

R: Sağ / Right / Rechts L: Sol/Left/Links

● Stokta / In Stock / Auf Lager ○ Stokta Yok / Non Stock Item / Kein Lagerartikel, Lieferzeit auf Anfrage

Sipariş Örneği/Ordering Example/Bestellbeispiel

1 ad./pcs./stück S16P SVQBR 11

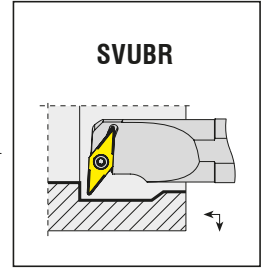
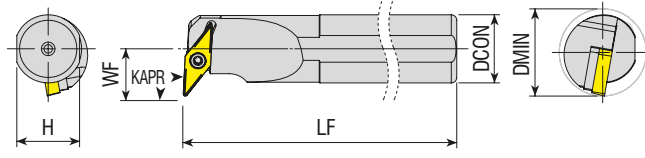

Takım Kodu Ordering Code Bestell-Bezeichnung	Stok Stock Lager		Takım Ölçüleri (mm) Dimension (mm) Abmessung (mm)					Kesici Uç Insert Wendeschneidplatte	Yedek Parçaları / Spare Parts / Ersatzteile			
	R	L	DCON	H	LF	WF	DMIN		Sıkma Vidası Screw Schraube	Altlık Shim Unterlage	Altlık Vidası Shim Screw Schraube für Unterlage	Tork Anahtar Torx Key Torx-Schlüssel
S16P SVUBR/L 11	●	●	16	14.8	170	12.5	≥20	VBM. 1103..	4008-M2.5x6	-	-	80-T08
S20R SVUBR/L 11	●	●	20	18.3	200	13	≥25					
S25S SVUBR/L 16	●	●	25	23	250	19	≥32	VBM. 1604..	4015-M3.5x14	AAVN-2-0002	AAV-06-M3.5x11	80-T15
S32T SVUBR/L 16	●	●	32	30	300	22	≥40					
S40U SVUBR/L 16	●	●	40	37.5	350	27	≥50					
A20Q SVUBR/L 16	●	○	20	18.3	180	20	≥30					
A32S SVUBR/L 16	●	●	32	30	250	22	≥40	4015-M3.5x14	AAVN-2-0002	AAV-06-M3.5x11		

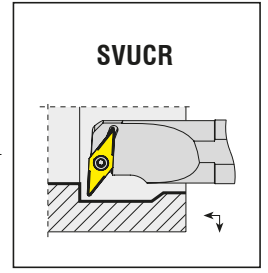
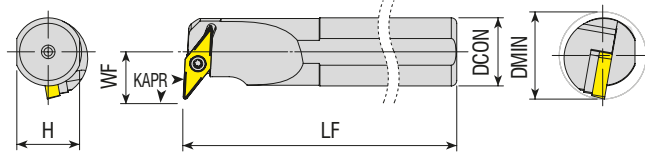

Takım Kodu Ordering Code Bestell-Bezeichnung	Stok Stock Lager		Takım Ölçüleri (mm) Dimension (mm) Abmessung (mm)					Kesici Uç Insert Wendeschneidplatte	Yedek Parçaları / Spare Parts / Ersatzteile			
	R	L	DCON	H	LF	WF	DMIN		Sıkma Vidası Screw Schraube	Altlık Shim Unterlage	Altlık Vidası Shim Screw Schraube für Unterlage	Tork Anahtar Torx Key Torx-Schlüssel
S16P SVUCR/L 11	●	●	16	14.8	170	12.5	≥20	VC.T 1103..	4008-M2.5x6	-	-	80-T08
S20R SVUCR/L 11	●	●	20	18.3	200	13	≥25					
S25S SVUCR/L 16	●	●	25	23	250	19	≥32	VC.T 1604..	4015-M3.5x14	AAVN-2-0002	AAV-06-M3.5x11	80-T15
S32T SVUCR/L 16	●	●	32	30	300	22	≥40					
S40U SVUCR/L 16	●	●	40	37.5	350	27	≥50					
A12K SVUCR/L 07	●	●	12	11	125	9	≥16					
A20Q SVUCR/L 11	●	○	20	18.3	180	13	≥25	VC.T 1103..	4008-M2.5x6	-	-	80-T08
A25R SVUCR/L 16	●	●	25	23	200	19	≥32	VC.T 1604..	4015-M3.5x14	AAVN-2-0002	AAV-06-M3.5x11	80-T15

R: Sağ / Right / Rechts L: Sol/Left/Links

● Stokta / In Stock / Auf Lager ○ Stokta Yok / Non Stock Item / Kein Lagerartikel, Lieferzeit auf Anfrage

Sipariş Örneği/Ordering Example/Bestellbeispiel

1 ad./pcs./stück S16P SVUBR 11

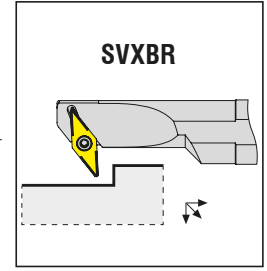
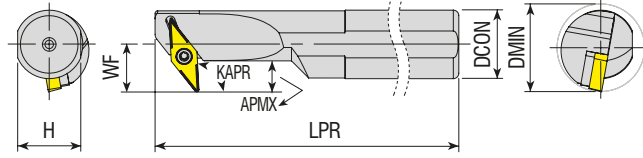

Takım Kodu Ordering Code Bestell-Bezeichnung	Stok Stock Lager		Takım Ölçüleri (mm) Dimension (mm) Abmessung (mm)					Kesici Uç Insert Wendeschneidplatte	Yedek Parçaları / Spare Parts / Ersatzteile				
	R	L	DCON	H	LPR	WF	APMX		DMIN	Sıkma Vidası Screw Schraube	Altık Shim Unterlage	Altık Vidası Shim Screw Schraube für Unterlage	Tork Anahtar Torx Key Torx-Schlüssel
S16P SVXBR/L 1102	●	○	16	14.8	170	12.5	7.2	≥20	VBM. 1102..	4008-M2.5x6	-	-	80-T08
S20R SVXBR/L 1102	●	●	20	18.3	200	13	5.7	≥25					
S16P SVXBR/L 11	●	●	16	14.8	170	12.5	7.2	≥20	VBM. 1103..	-	-	80-T08	
S20R SVXBR/L 11	●	●	20	18.3	200	13	5.7	≥25					
S25S SVXBR/L 16	●	●	25	23	250	19	10.2	≥32	VBM. 1604..	4015-M3.5x14	AAVN-2-0002	AAV-06-M3.5x11	80-T15
S32T SVXBR/L 16	●	●	32	30	300	22	11.7	≥40					
S40U SVXBR/L 16	●	●	40	37.5	350	27	14.3	≥50					

Not: "APMX" ölçüleri R0.4'e göre verilmiştir.
Note: Dimensions of "APMX" are given according to R.04.
Hinweis: Das Maß "APMX" bezieht sich auf R 0,4

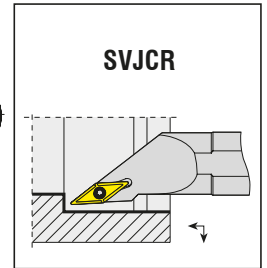
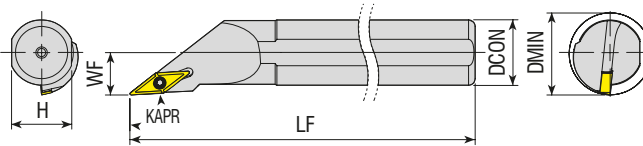

Takım Kodu Ordering Code Bestell-Bezeichnung	Stok Stock Lager		Takım Ölçüleri (mm) Dimension (mm) Abmessung (mm)					Kesici Uç Insert Wendeschneidplatte	Yedek Parçaları / Spare Parts / Ersatzteile			
	R	L	DCON	H	LF	WF	DMIN		Sıkma Vidası Screw Schraube	Altık Shim Unterlage	Altık Vidası Shim Screw Schraube für Unterlage	Tork Anahtar Torx Key Torx-Schlüssel
S12K SVJCR/L 11	●	●	12	11	125	7	13	VC.T 1103..	4008-M2.5x6	-	-	80-T08
S16P SVJCR/L 11	●	●	16	14.8	170	11	20					
S20R SVJCR/L 11	●	●	20	18.3	200	13	25					

R: Sağ / Right / Rechts L: Sol/Left/Links
● Stokta / In Stock / Auf Lager ○ Stokta Yok / Non Stock Item / Kein Lagerartikel, Lieferzeit auf Anfrage

Sipariş Örneği/Ordering Example/Bestellbeispiel
1 ad./pcs./stück S16P SVXBR 1102

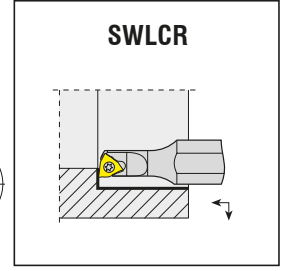
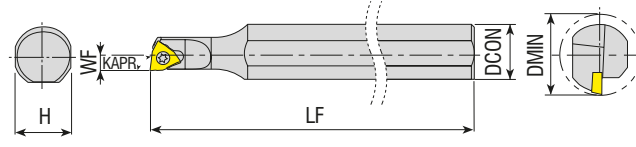

Takım Kodu Ordering Code Bestell-Bezeichnung	Stok Stock Lager	Takım Ölçüleri (mm) Dimension (mm) Abmessung (mm)					Kesici Uç Insert Wendeschneidplatte	Yedek Parçaları / Spare Parts / Ersatzteile			
		DCON	H	LF	WF	DMIN		Sıkma Vidası Screw Schraube	Altlık Shim Unterlage	Altlık Vidası Shim Screw Schraube für Unterlage	Tork Anahtar Torx Key Torx-Schlüssel
S0608H SWLCR 03	●	08	7.3	100	04	≥08	WC.. 0302..	4008-M2.5x4	-	-	80-T08
S0810K SWLCR 03	●	10	09	125	06	≥10		4008-M2.5x4.5	-	-	

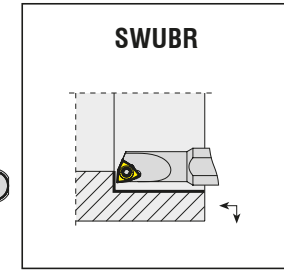
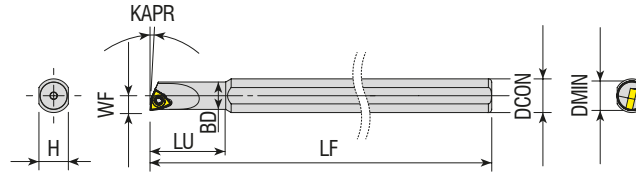

Takım Kodu Ordering Code Bestell-Bezeichnung	Stok Stock Lager	Takım Ölçüleri (mm) Dimension (mm) Abmessung (mm)							Kesici Uç Insert Wendeschneidplatte	Yedek Parçaları / Spare Parts / Ersatzteile			
		DCON	BD	H	LU	LF	DMIN	WF		Sıkma Vidası Screw Schraube	Altlık Shim Unterlage	Altlık Vidası Shim Screw Schraube für Unterlage	Tork Anahtar Torx Key Torx-Schlüssel
S0610H SWUBR 06	●	10	5	7.3	18	100	≥6	3	WBGT 060102-L	3006-M2x3.3	-	-	80-T06
S08H SWUBR 06-5.5	●	08	5	7.3	18	100	≥5.7	2.75		3006-M2x4	-	-	
S08H SWUBR 06-7	●	08	6.5	7.3	18	100	≥7	3.5		-	-	-	

R: Sağ / Right / Rechts L: Sol/Left/Links

● Stokta / In Stock / Auf Lager ○ Stokta Yok / Non Stock Item / Kein Lagerartikel, Lieferzeit auf Anfrage

KYCR-ISCR Ucuna Uygundur. / Compatiple with KYCR-ISCR Insert. / Kompatibel mit KYCR-ISCR Wendeplatten.

Sipariş Örneği/Ordering Example/Bestellbeispiel

1 ad./pcs./stück S0608H SWLCR 03

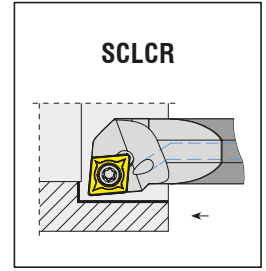
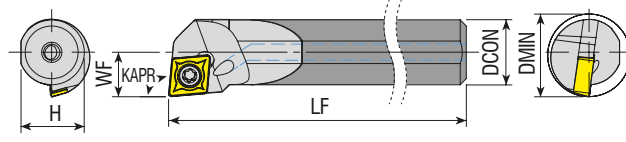

Takım Kodu Ordering Code Bestell-Bezeichnung	Stok Stock Lager		Takım Ölçüleri (mm) Dimension (mm) Abmessung (mm)				Kesici Uç Insert Wendeschneidplatte	Yedek Parçaları / Spare Parts / Ersatzteile				
	R	L	DCON	H	LF	WF		DMIN	Sıkma Vidası Screw Schraube	Altlık Shim Unterlage	Altlık Vidası Shim Screw Schraube für Unterlage	Tork Anahtar Torx Key Torx-Schlüssel
E08K SCLCR/L 06	●	●	8	7.5	125	6	≥11	CC.T 0602..	4008-M2.5x6	-	-	80-T08
E10M SCLCR/L 06	●	●	10	9.5	150	7	≥13					
E12Q SCLCR/L 06	●	●	12	11	180	9	≥16					
E16R SCLCR/L 09	●	●	16	15	200	11	≥20	CC.T 09T3..	4015-M3.5x9	-	-	80-T15
E20S SCLCR/L 09	●	●	20	19	250	13	≥24					

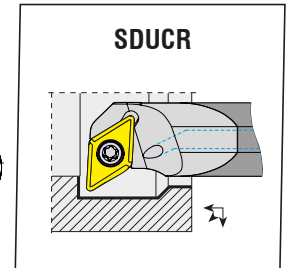
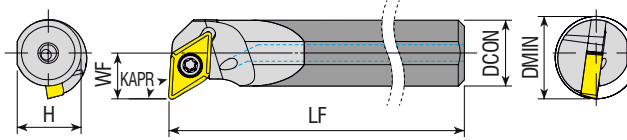

Takım Kodu Ordering Code Bestell-Bezeichnung	Stok Stock Lager		Takım Ölçüleri (mm) Dimension (mm) Abmessung (mm)				Kesici Uç Insert Wendeschneidplatte	Yedek Parçaları / Spare Parts / Ersatzteile				
	R	L	DCON	H	LF	WF		DMIN	Sıkma Vidası Screw Schraube	Altlık Shim Unterlage	Altlık Vidası Shim Screw Schraube für Unterlage	Tork Anahtar Torx Key Torx-Schlüssel
E10M SDUCR/L 07	●	●	10	9.5	150	8	≥13	DC.T 0702..	4008-M2.5x6	-	-	80-T08
E12Q SDUCR/L 07	●	●	12	11	180	9	≥16					
E16R SDUCR/L 11	●	●	16	15	200	11	≥20					
E20S SDUCR/L 11	●	●	20	18.3	250	12	≥23	DC.T 11T3..	4015-M3.5x9	-	-	80-T15

R: Sağ / Right / Rechts L: Sol/Left/Links

● Stokta / In Stock / Auf Lager ○ Stokta Yok / Non Stock Item / Kein Lagerartikel, Lieferzeit auf Anfrage

Sipariş Örneği/Ordering Example/Bestellbeispiel

1 ad./pcs./stück E08K SCLCR 06

SET-A/SCLCR/L

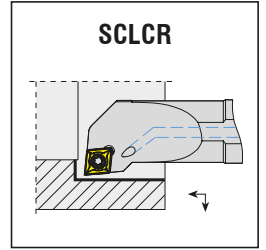
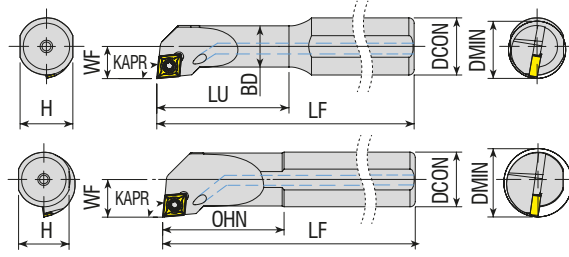

Takım Kodu
Ordering Code
Bestell-Bezeichnung

Stok
Stock
Lager

Takım Ölçüleri (mm)
Dimension (mm)
Abmessung (mm)

Kesici Uç
Insert
Wendeschneidplatte

Yedek Parçaları / Spare Parts / Ersatzteile

Sıkma Vidası
Screw
Schraube

Altlık
Shim
Unterlage

Altlık Vidası
Shim Screw
Schraube für Unterlage

Tork Anahtar
Torx Key
Torx-Schlüssel

R	L	DCON	BD	H	LU=OHN	LF	WF	DMIN
---	---	------	----	---	--------	----	----	------



A08H SCLCR/L 06

●●	●●	8	8	7.3	20	100	6	≥11
----	----	---	---	-----	----	-----	---	-----

CC.T 0602..

4008-M2.5x6

-

-

80-T08

A10H SCLCR/L 06

●●	●●	10	10	9	25	100	7	≥13
----	----	----	----	---	----	-----	---	-----

CC.T 0602..

4008-M2.5x6

-

-

80-T08

A12H SCLCR/L 06

●●	●●	12	12	11	25	100	9	≥16
----	----	----	----	----	----	-----	---	-----

CC.T 09T3..

4015-M3.5x9

-

-

80-T15

A16M SCLCR/L 09

●●	●●	16	16	14.8	35	150	11	≥20
----	----	----	----	------	----	-----	----	-----

CC.T 09T3..

4015-M3.5x9

-

-

80-T15

SET-E/SCLCR/L

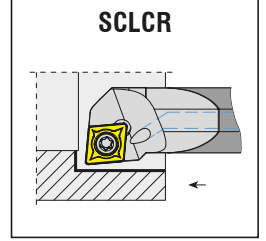
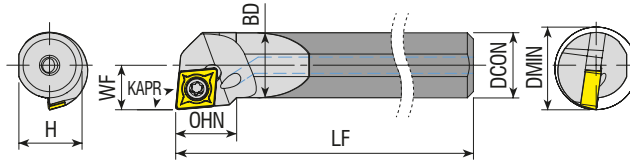

Takım Kodu
Ordering Code
Bestell-Bezeichnung

Stok
Stock
Lager

Takım Ölçüleri (mm)
Dimension (mm)
Abmessung (mm)

Kesici Uç
Insert
Wendeschneidplatte

Yedek Parçaları / Spare Parts / Ersatzteile

Sıkma Vidası
Screw
Schraube

Altlık
Shim
Unterlage

Altlık Vidası
Shim Screw
Schraube für Unterlage

Tork Anahtar
Torx Key
Torx-Schlüssel

R	L	DCON	BD	H	OHN	LF	WF	DMIN
---	---	------	----	---	-----	----	----	------

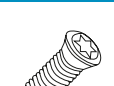

E08K SCLCR/L 06

●○	○	8	8	7.5	10	125	6	≥11
----	---	---	---	-----	----	-----	---	-----

CC.T 0602..

4008-M2.5x6

-

-

80-T08

E10M SCLCR/L 06

●○	○	10	10	9.5	10	150	7	≥13
----	---	----	----	-----	----	-----	---	-----

CC.T 0602..

4008-M2.5x6

-

-

80-T08

E12Q SCLCR/L 06

●○	○	12	12	11	12	180	9	≥16
----	---	----	----	----	----	-----	---	-----

CC.T 09T3..

4015-M3.5x9

-

-

80-T15

E16R SCLCR/L 09

●○	○	16	16	15	15	200	11	≥20
----	---	----	----	----	----	-----	----	-----

CC.T 09T3..

4015-M3.5x9

-

-

80-T15

SET-S/SCLCR/L

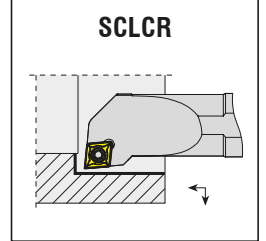
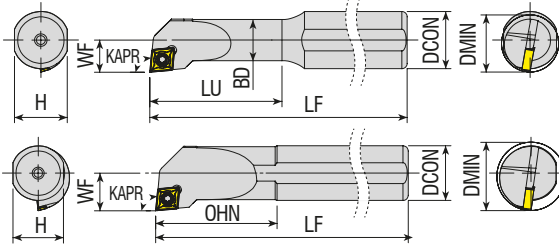

Takım Kodu
Ordering Code
Bestell-Bezeichnung

Stok
Stock
Lager

Takım Ölçüleri (mm)
Dimension (mm)
Abmessung (mm)

Kesici Uç
Insert
Wendeschneidplatte

Yedek Parçaları / Spare Parts / Ersatzteile

Sıkma Vidası
Screw
Schraube

Altlık
Shim
Unterlage

Altlık Vidası
Shim Screw
Schraube für Unterlage

Tork Anahtar
Torx Key
Torx-Schlüssel

R	L	DCON	BD	H	LU=OHN	LF	WF	DMIN
---	---	------	----	---	--------	----	----	------



S08H SCLCR/L 06

●●	●●	8	8	7.3	20	100	6	≥11
----	----	---	---	-----	----	-----	---	-----

CC.T 0602..

4008-M2.5x6

-

-

80-T08

S10K SCLCR/L 06

●●	●●	10	10	9	25	125	7	≥13
----	----	----	----	---	----	-----	---	-----

CC.T 0602..

4008-M2.5x6

-

-

80-T08

S12K SCLCR/L 06

●●	●●	12	12	11	25	125	9	≥16
----	----	----	----	----	----	-----	---	-----

CC.T 09T3..

4015-M3.5x9

-

-

80-T15

S16P SCLCR/L 09

●●	●●	16	16	14.8	35	170	11	≥20
----	----	----	----	------	----	-----	----	-----

CC.T 09T3..

4015-M3.5x9

-

-

80-T15

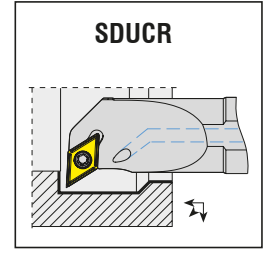
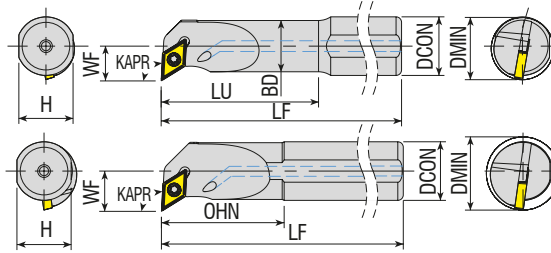

Takım Kodu
Ordering Code
Bestell-Bezeichnung

Stok Stock Lager	Takım Ölçüleri (mm) Dimension (mm) Abmessung (mm)								Kesici Uç Insert Wendeschneidplatte	Yedek Parçaları / Spare Parts / Ersatzteile				
	R	L	DCON	BD	H	LU=OHN	LF	WF		DMIN	Sıkma Vidası Screw Schraube	Altlık Shim Unterlage	Altlık Vidası Shim Screw Schraube für Unterlage	Tork Anahtar Torx Key Torx-Schlüssel
	●	●	10	10	09	25	100	08	≥13	DC.T 0702..	4008-M2.5x6	-	-	80-T08
A10H SDUCR/L 07	●	●	12	12	11	25	100	09	≥16					
A12H SDUCR/L 07	●	●	16	16	14.8	35	150	11	≥20					

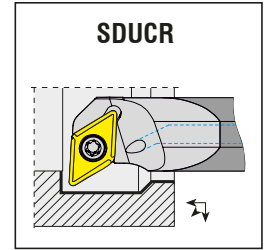
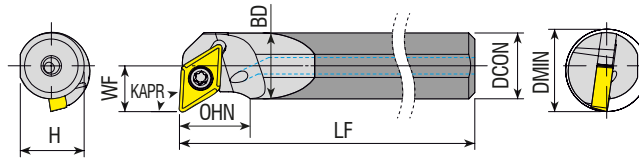

Takım Kodu
Ordering Code
Bestell-Bezeichnung

Stok Stock Lager	Takım Ölçüleri (mm) Dimension (mm) Abmessung (mm)								Kesici Uç Insert Wendeschneidplatte	Yedek Parçaları / Spare Parts / Ersatzteile				
	R	L	DCON	BD	H	OHN	LF	WF		DMIN	Sıkma Vidası Screw Schraube	Altlık Shim Unterlage	Altlık Vidası Shim Screw Schraube für Unterlage	Tork Anahtar Torx Key Torx-Schlüssel
	●	○	10	10	9.5	09	150	8	≥13	DC.T 0702..	4008-M2.5x6	-	-	80-T08
E10M SDUCR/L 07	●	○	12	12	11	10	180	9	≥16					
E12Q SDUCR/L 07	●	○	16	16	15	12	200	11	≥20					

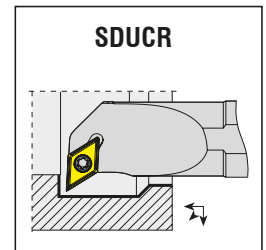
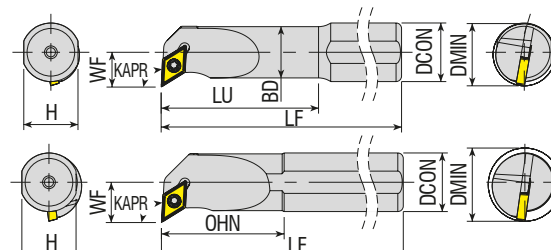

Takım Kodu
Ordering Code
Bestell-Bezeichnung

Stok Stock Lager	Takım Ölçüleri (mm) Dimension (mm) Abmessung (mm)								Kesici Uç Insert Wendeschneidplatte	Yedek Parçaları / Spare Parts / Ersatzteile				
	R	L	DCON	BD	H	LU=OHN	LF	WF		DMIN	Sıkma Vidası Screw Schraube	Altlık Shim Unterlage	Altlık Vidası Shim Screw Schraube für Unterlage	Tork Anahtar Torx Key Torx-Schlüssel
	●	●	10	10	9	25	125	8	≥13	DC.T 0702..	4008-M2.5x6	-	-	80-T08
S10K SDUCR/L 07	●	●	12	12	11	25	125	9	≥16					
S12K SDUCR/L 07	●	●	16	16	14.8	35	170	11	≥20					



*konusulan
the spoken kalite...
quality...*

KARTUŞLAR

KARTUŞLAR
CARTRIDGE
KURZDREHHALTER



S

1

T

2

F

3

C

4

R

5

12

6

C

7



A

8

16

9

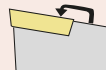

1 Sıkma Tipi / Method of Mounting of Insert / Klemmsystem

		
Deliksiz Üstten Sıkma Top Clamping Without Hole Pratzenklemmung	Delikten Levye ile Sıkma Hole Clamping (Lever Lock) Kniehebel-Spannsystem	Vida ile Sıkma Screw on Schrauben-Spannsystem
C	P	S

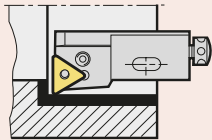
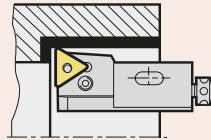
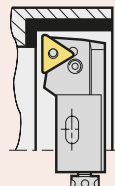
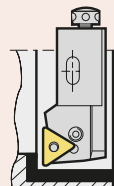
5 Kesme Yönü / Cutting Direction / Halterausführung

	
	
R	L

2 Uç Tipi / Type of Insert / Plattenform

		
C	S	T

3 Yanaşma Açısı / Tool Holder Shape Bar Geometry / Anstellwinkel

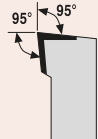
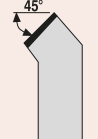
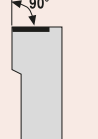
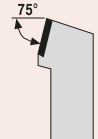
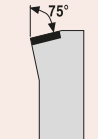
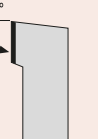
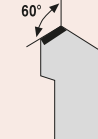
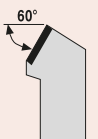
		
L	S	F
		
R	K	G
		
W	T	

6 Kesme Kenar Yüksekliği / Cutting Edge Height / Drehhalterhöhe

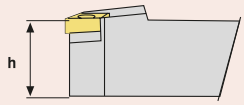



7 Kartuş Kodu / Cartridge Code / Kurzdrehhalter Bezeichnung

C (Kartuş / Cartridge Code / Kurzdrehhalter Bezeichnung)
--



8 Kartuş Tipi / Cartridge Type / Art der Kurzdrehhalter

A (ISO 5611)

4 Serbest Uç Açısı / Insert Clearance Angle / Freiwinkel

		
C	P	N

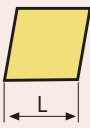
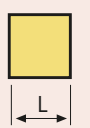
9 Kesme Kenar Uzunluğu / Cutting Edge Length / Halterausführung

		
--	---	---

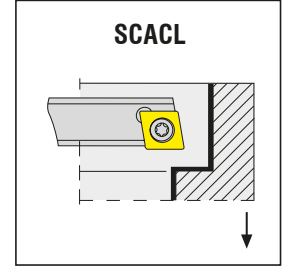
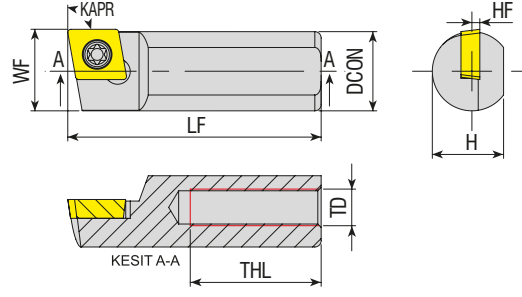

Takım Kodu Ordering Code Bestell-Bezeichnung	Stok Stock Lager		Takım Ölçüleri (mm) Dimension (mm) Abmessung (mm)							Kesici Uç Insert Wendeschneidplatte	Yedek Parçaları / Spare Parts / Ersatzteile	
	R	L	DCON	H	LF	THL	HF	WF	TD		Sıkma Vidası Screw Schraube	Tork Anahtar Torx Key Torx-Schlüssel
S10X SCACR/L 06	●	●	10	9	25	10	1	10.3	M5x0.8	CC.. 0602..	4008-M2.5x6	80-T08
S10A SCACR/L 06	●	●	10	9	32	15	1	10.3	M5x0.8			
S1018 SCACR/L 06	○	●	10	9	18	8	1	9.8	M5x0.8			
S1065 SCACR/L 06	○	●	10	9	65	5	1	10.3	M5x0.8			
S10C SCACR/L 06	●	●	10	9	50	25	1	10.3	M5x0.8			
S12B SCACR/L 06	●	●	12	11	40	25	1	12.3	M5x0.8			
S12D SCACR/L 06	●	●	12	11	60	25	1	12.3	M5x0.8			
S12D SCACR/L 09	●	●	12	11	60	25	2	12.2	M5x0.8			
S1265 SCACR/L 09	○	●	12	11	65	25	2	12.3	M5x0.8			
S12H SCACR/L 09	●	●	12	11	100	25	2	12.2	M5x0.8			
S15C SCACR/L 09	●	●	15	14	50	25	2	15.3	M8x1.25	CC.. 09T3..	4015-M3.5x8	80-T15
S1554 SCACR/L 09	○	●	15	14	54	25	2	15.3	M8x1.25			
S15E SCACR/L 09	○	●	15	14	70	45	2	15.3	M8x1.25			
S15D SCACR/L 09	○	●	15	14	60	30	2	15.3	M8x1.25			
S16A SCACR/L 09	●	●	16	15	32	15	2	16.5	M6x1			
S16B SCACR/L 09	●	●	16	15	40	20	2	16.5	M6x1			
S16C SCACR/L 09	○	●	16	15	50	25	2	16.5	M6x1			
S16D SCACR/L 09	●	●	16	15	60	30	2	16.5	M6x1			
S16E SCACR/L 09	○	●	16	15	70	30	2	16.5	M6x1			
S16G SCACR/L 09	●	●	16	15	90	30	2	16.5	M6x1			
S16H SCACR/L 09	○	●	16	15	100	35	4	16.5	M6x1			
S1868 SCACR/L 09	○	●	18	17	68	30	2	18.5	M8x1.25	CC.. 1204..	1020-M5x11	80-T20
S18E SCACR/L 09	●	●	18	17	70	30	2	18.5	M8x1.25			
S1888 SCACR/L 09	○	●	18	17	88	30	2	18.5	M8x1.25			
S18105 SCACR/L 09	○	●	18	17	105	30	2	18.5	M8x1.25			
S18175 SCACR/L 09	○	●	18	17	175	30	2	18.5	M8x1.25			
S20E SCACR/L 09	●	●	20	18.3	70	30	2	20.5	M6x1			
S20E SCACR/L 12	●	●	20	18.3	70	30	2	20.5	M6x1			
S20H SCACR/L 12	●	●	20	18.3	100	30	2	20.5	M6x1			

R: Sağ / Right / Rechts L: Sol/Left/Links

● Stokta / In Stock / Auf Lager ○ Stokta Yok / Non Stock Item / Kein Lagerartikel, Lieferzeit auf Anfrage

Sipariş Örneği/Ordering Example/Bestellbeispiel

1 ad./pcs./stück S10X SCACR 06

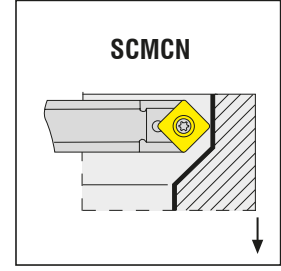
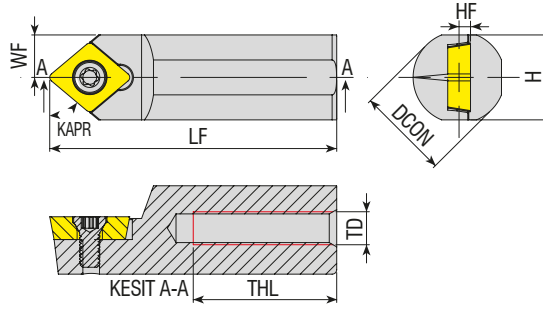

Takım Kodu Ordering Code Bestell-Bezeichnung	Stok Stock Lager	Takım Ölçüleri (mm) Dimension (mm) Abmessung (mm)						Kesici Uç Insert Wendeschneidplatte	Yedek Parçaları / Spare Parts / Ersatzteile		
		DCON	H	LF	THL	HF	WF		TD	Sıkma Vidası Screw Schraube	Tork Anahtar Torx Key Torx-Schlüssel
S10X SCMCN 06	●	10	9	25	10	1	5	M5x0.8	CC.. 0602..	4008-M2.5x6	80-T08
S12D SCMCN 06	●	12	11	60	25	1	6	M5x0.8			
S16C SCMCN 09	●	16	15	50	25	2	8	M6x1	CC.. 09T3..	4015-M3.5x11	80-T15
S16D SCMCN 09	●	16	15	60	25	4	8	M6x1			

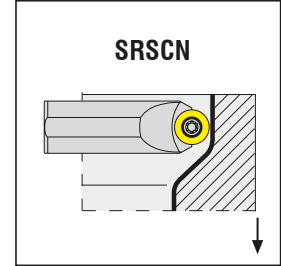
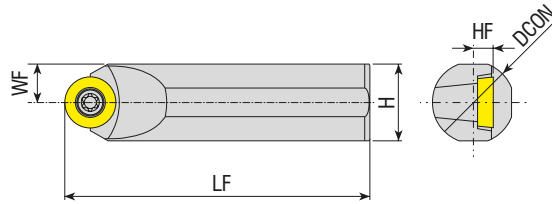

Takım Kodu Ordering Code Bestell-Bezeichnung	Stok Stock Lager	Takım Ölçüleri (mm) Dimension (mm) Abmessung (mm)					Kesici Uç Insert Wendeschneidplatte	Yedek Parçaları / Spare Parts / Ersatzteile	
		DCON	H	WF	HF	LF		Sıkma Vidası Screw Schraube	Tork Anahtar Torx Key Torx-Schlüssel
S12D SRSCN 10	●	12	11	6	3.9	60	RC. 10T3	4015-M3.5x9	80-T15
S14D SRSCN 10	●	14	13	7	3.9	60		4015-M3.5x11	
S16D SRSCN 10	●	16	15	8	3.9	60			

R: Sağ / Right / Rechts L: Sol/Left/Links
● Stokta / In Stock / Auf Lager ○ Stokta Yok / Non Stock Item / Kein Lagerartikel, Lieferzeit auf Anfrage

Sipariş Örneği/Ordering Example/Bestellbeispiel
1 ad./pcs./stück S10X SCMCN 06

➤ **S-TİP REKTEFİYE KARTUŞLARI**
S-TYPE ENGINE OVERHAUL CARTRIDGE
S-SYSTEM KURZDREHHALTER FÜR DIE MOTORINSTANDHALTUNG

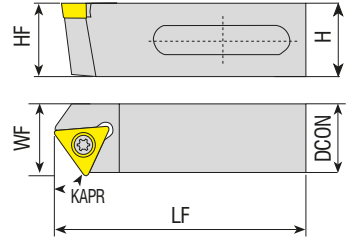

Takım Kodu Ordering Code Bestell-Bezeichnung	Stok Stock Lager		Takım Ölçüleri (mm) Dimension (mm) Abmessung (mm)				Kesici Uç Insert Wendeschneidplatte	Yedek Parçaları / Spare Parts / Ersatzteile		
	R	L	DCON	H	HF	LF		WF	Sıkma Vidası Screw Schraube	Tork Anahtar Torx Key Torx-Schlüssel
STXCR/L 2020 B16	○	●	20	20	20	45	20	TC.. 16T3..	4015-M3.5x11	80-T15
STXCR/L 2020 E16	○	●	20	20	20	70	20			
STXCR/L 2020 B16-SA	○	●	20	10	20	45	20			
STXCR/L 2020 E16-SA	○	●	20	10	20	70	20			
STXCR/L 2020 B16-PL	○	●	20	10	20	45	20			
STXCR/L 2020 E16-PL	○	●	20	10	20	70	20			
STXCR/L 2020 H16-PL	○	●	20	10	20	100	20			

➤ **S-SİSTEM KARTUŞLAR**
S-SYSTEM CARTRIDGE
S-SYSTEM KURZDREHHALTER

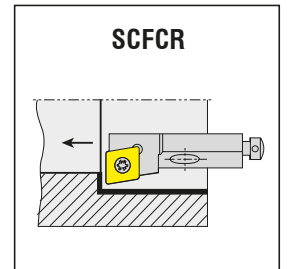
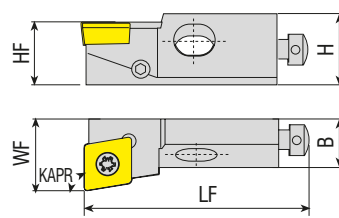
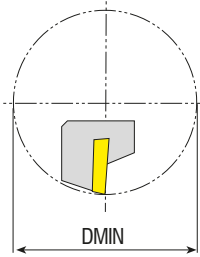

Takım Kodu Ordering Code Bestell-Bezeichnung	Stok Stock Lager		Takım Ölçüleri (mm) Dimension (mm) Abmessung (mm)					Kesici Uç Insert Wendeschneidplatte	Yedek Parçaları / Spare Parts / Ersatzteile				
	R	L	HF	H	B	LF	WF		DMIN	Altlık Shim Unterlage	Altlık Vidası Shim Screw Schraube für Unterlage	Sıkma Vidası Screw Schraube	Tork Anahtar Torx Key Torx-Schlüssel
SCFCR/L 06CA 06	●	●	6	8.5	6	25	8	≥20	CC.T 060204	-	-	4008-M2.5x6	80-T08
SCFCR/L 08CA 06	●	●	8	11	8	32	10	≥25					
SCFCR/L 10CA 09	●	●	10	15	11	50	14	≥40					
SCFCR/L 12CA 12	●	○	12	20	15	55	20	≥50					
SCFCR/L 16CA 12	●	●	16	21	20	63	25	≥60					
									AACN-2-0003	AAV-10-M4.5x8	4020-M4.5x12	80-T20	

R: Sağ / Right / Rechts L: Sol/Left/Links

● Stokta / In Stock / Auf Lager ○ Stokta Yok / Non Stock Item / Kein Lagerartikel, Lieferzeit auf Anfrage

Sipariş Örneği/Ordering Example/Bestellbeispiel
1 ad./pcs./stück STXCR 2020 B16



www.akko.com.tr

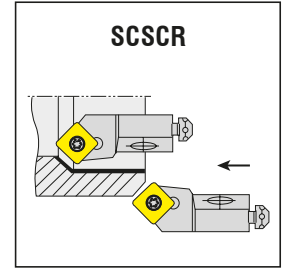
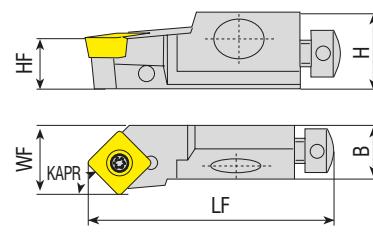
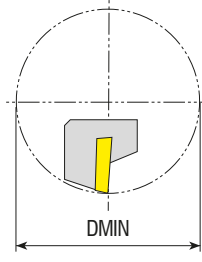

Takım Kodu Ordering Code Bestell-Bezeichnung	Stok Stock Lager		Takım Ölçüleri (mm) Dimension (mm) Abmessung (mm)					Kesici Uç Insert Wendeschneidplatte	Yedek Parçaları / Spare Parts / Ersatzteile				
	R	L	HF	H	B	LF	WF		DMIN	Altlık Shim Unterlage	Altlık Vidası Shim Screw Schraube für Unterlage	Sıkma Vidası Screw Schraube	Tork Anahtar Torx Key Torx-Schlüssel
SCSCR/L 06CA 06	●	○	6	8	6	30	8	≥20	CC.T 060204	-	-	4008-M2.5x6	80-T08
SCSCR/L 10CA 09	●	○	10	15	11	50	14	≥40	CC.T 09T308	-	-	4015-M3.5x14	80-T15
SCSCR/L 12CA 12	○	○	12	20	15	55	20	≥50	CC.T 120408	-	-	1020-M5x11	80-T20

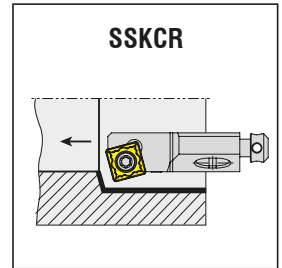
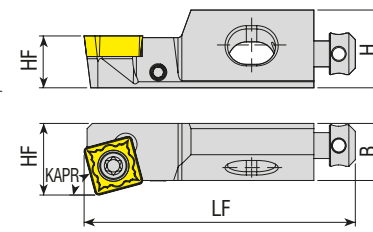
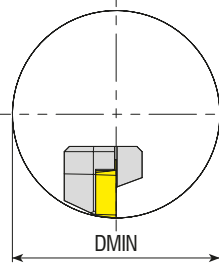

Takım Kodu Ordering Code Bestell-Bezeichnung	Stok Stock Lager		Takım Ölçüleri (mm) Dimension (mm) Abmessung (mm)					Kesici Uç Insert Wendeschneidplatte	Yedek Parçaları / Spare Parts / Ersatzteile				
	R	L	HF	H	B	LF	WF		DMIN	Altlık Shim Unterlage	Altlık Vidası Shim Screw Schraube für Unterlage	Sıkma Vidası Screw Schraube	Tork Anahtar Torx Key Torx-Schlüssel
SSKCR/L 10CA 09	●	○	10	15	11	50	14	≥40	SC.T 09T308	-	-	4015-M3.5x11	80-T15
SSKCR/L 12CA 12	●	○	12	20	15	55	20	≥50	SC.T 120408	-	-	1020-M5x11	80-T20

R: Sağ / Right / Rechts L: Sol/Left/Links

● Stokta / In Stock / Auf Lager ○ Stokta Yok / Non Stock Item / Kein Lagerartikel, Lieferzeit auf Anfrage

Sipariş Örneği/Ordering Example/Bestellbeispiel

1 ad./pcs./stück SCSCR 06CA 06

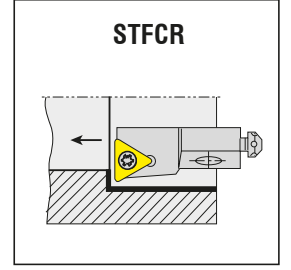
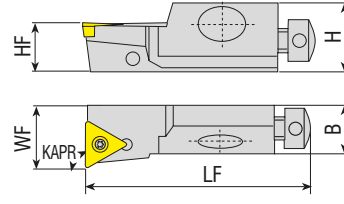
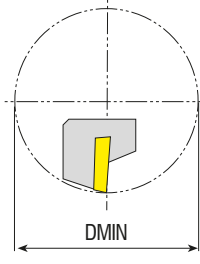

Takım Kodu Ordering Code Bestell-Bezeichnung	Stok Stock Lager		Takım Ölçüleri (mm) Dimension (mm) Abmessung (mm)					Kesici Uç Insert Wendeschneidplatte	Yedek Parçaları / Spare Parts / Ersatzteile				
	R	L	HF	H	B	LF	WF		DMIN	Altlık Shim Unterlage	Altlık Vidası Shim Screw Schraube für Unterlage	Sıkma Vidası Screw Schraube	Tork Anahtar Torx Key Torx-Schlüssel
STFCR/L 08CA 09	●	●	8	11	8	32	10	≥25	TC.T 090204	-	-	3007-M2.2x5	80-T07
STFCR/L 10CA 11	●	●	10	15	11	50	14	≥40	TC.T 110204	-	-	4008-M2.5x6	80-T08
STFCR/L 12CA 16	●	○	12	20	15	55	20	≥50	TC.T 16T308	-	-	4015-M3.5x11	80-T15
STFCR/L 16CA 16	●	●	16	21	20	63	25	≥60		AATN-2-0001	AAV-06-M3.5x11	4015-M3.5x14	

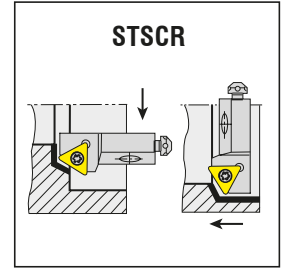
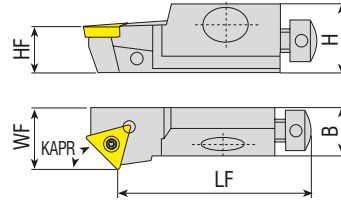
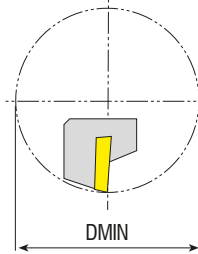

Takım Kodu Ordering Code Bestell-Bezeichnung	Stok Stock Lager		Takım Ölçüleri (mm) Dimension (mm) Abmessung (mm)					Kesici Uç Insert Wendeschneidplatte	Yedek Parçaları / Spare Parts / Ersatzteile				
	R	L	HF	H	B	LF	WF		DMIN	Altlık Shim Unterlage	Altlık Vidası Shim Screw Schraube für Unterlage	Sıkma Vidası Screw Schraube	Tork Anahtar Torx Key Torx-Schlüssel
STSCR/L 08CA 09	●	○	8	11	8	28	10	≥25	TC.T 090204	-	-	3007-M2.2x5	80-T07
STSCR/L 10CA 11	●	●	10	15	11	44	14	≥40	TC.T 110204	-	-	4008-M2.5x6	80-T08
STSCR/L 12CA 16	●	○	12	20	15	47	20	≥50	TC.T 16T308	-	-	4015-M3.5x11	80-T15

R: Sağ / Right / Rechts L: Sol/Left/Links
● Stokta / In Stock / Auf Lager ○ Stokta Yok / Non Stock Item / Kein Lagerartikel, Lieferzeit auf Anfrage

Sipariş Örneği/Ordering Example/Bestellbeispiel
1 ad./pcs./stück STFCR 08CA 09

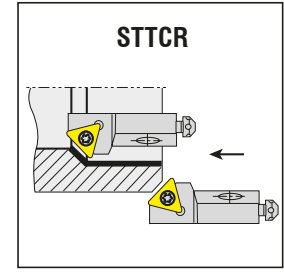
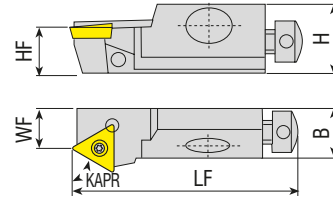
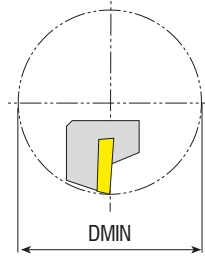

Takım Kodu Ordering Code Bestell-Bezeichnung	Stok Stock Lager		Takım Ölçüleri (mm) Dimension (mm) Abmessung (mm)					Kesici Uç Insert Wendeschneidplatte	Yedek Parçaları / Spare Parts / Ersatzteile				
	R	L	HF	H	B	LF	WF		DMIN	Altlık Shim Unterlage	Altlık Vidası Shim Screw Schraube für Unterlage	Sıkma Vidası Screw Schraube	Tork Anahtar Torx Key Torx-Schlüssel
STTCR/L 08CA 09	●	●	8	11	8	32	6	≥25	TC.T 090204	-	-	3007-M2.2x5	80-T07
STTCR/L 10CA 11	●	●	10	15	11	50	9	≥40	TC.T 110204	-	-	4008-M2.5x6	80-T08

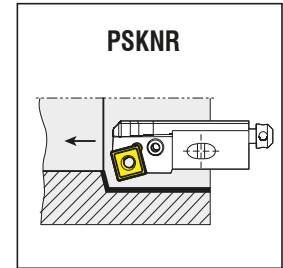
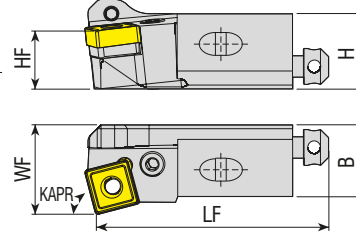
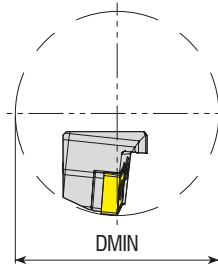

Takım Kodu Ordering Code Bestell-Bezeichnung	Stok Stock Lager		Takım Ölçüleri (mm) Dimension (mm) Abmessung (mm)					Kesici Uç Insert Wendeschneidplatte	Yedek Parçaları / Spare Parts / Ersatzteile					
	R	L	HF	H	B	LF	WF		DMIN	Levy Lever Kniehebel	Levy Vidası Lever Screw Kniehebelschraube	Altlık Shim Unterlage	Altlık Yay Shim Spring Feder für Unterlage	Anahtar Allen Key Innensechskantschlüssel
PSKNR/L 16CA 12	●	●	16	21	20	63	25	≥60	SNM.120408	APL-02	ALV-08-M8x16	AASN-3-0004	AAV-02	AAL-02-2.5

R: Sağ / Right / Rechts L: Sol/Left/Links

● Stokta / In Stock / Auf Lager ○ Stokta Yok / Non Stock Item / Kein Lagerartikel, Lieferzeit auf Anfrage

Sipariş Örneği/Ordering Example/Bestellbeispiel
1 ad./pcs./stück STTCR 08CA 09

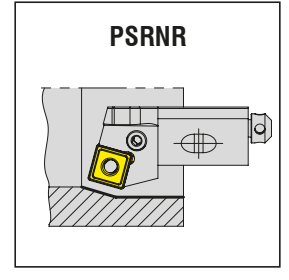
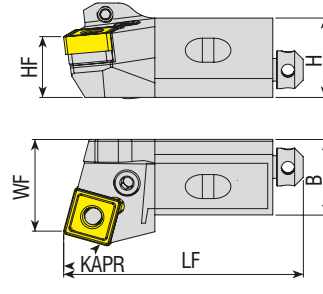
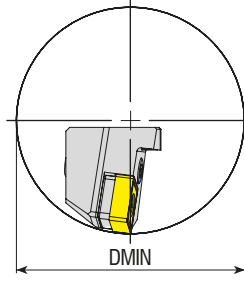

Takım Kodu Ordering Code Bestell-Bezeichnung	Stok Stock Lager		Takım Ölçüleri (mm) Dimension (mm) Abmessung (mm)					Kesici Uç Insert Wendeschneidplatte	Yedek Parçaları / Spare Parts / Ersatzteile					
	R	L	HF	H	B	LF	WF		DMIN	Levyeye Lever Kniehebel	Levyeye Vidası Lever Screw Kniehebelschraube	Altılık Shim Unterlage	Altılık Yayı Shim Spring Feder für Unterlage	Anahtar Allen Key Innerschlüsselschlüssel
PSRNR/L 16CA 12	○	●	16	21	20	55	25	≥60						
									SNM.120408	APL-02	ALV-03-M8x19	AASN-3-0004	AAY-02	AAL-03-3

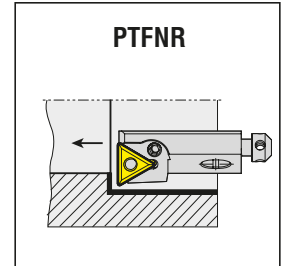
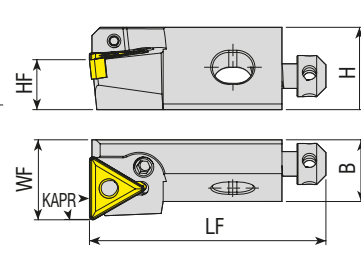
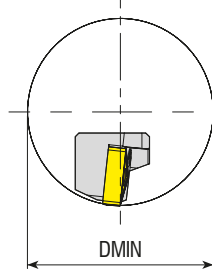

Takım Kodu Ordering Code Bestell-Bezeichnung	Stok Stock Lager		Takım Ölçüleri (mm) Dimension (mm) Abmessung (mm)					Kesici Uç Insert Wendeschneidplatte	Yedek Parçaları / Spare Parts / Ersatzteile					
	R	L	HF	H	B	LF	WF		DMIN	Levyeye Lever Kniehebel	Levyeye Vidası Lever Screw Kniehebelschraube	Altılık Shim Unterlage	Altılık Yayı Shim Spring Feder für Unterlage	Anahtar Allen Key Innerschlüsselschlüssel
PTFNR/L 12CA 16	●	●	12	20	15	47	20	≥50						
PTFNR/L 16CA 16	●	○	16	21	20	55	25	≥60	TNM.160408	APL-08	ALV-07-M6x13	-	AAY-07	AAL-02-2.5
										APL-01	ALV-01-M6x14	AATN-3-0025	AAY-01	

R: Sağ / Right / Rechts L: Sol/Left/Links
● Stokta / In Stock / Auf Lager ○ Stokta Yok / Non Stock Item / Kein Lagerartikel, Lieferzeit auf Anfrage

Sipariş Örneği/Ordering Example/Bestellbeispiel
1 ad./pcs./stück PSRNR 16CA 12

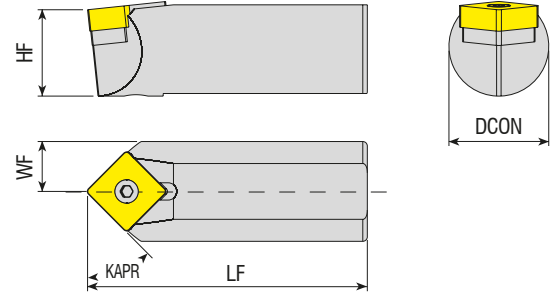

Takım Kodu
Ordering Code
Bestell-Bezeichnung

Stok Stock Lager	Takım Ölçüleri (mm) Dimension (mm) Abmessung (mm)				Kesici Uç Insert Wendeschneidplatte	Yedek Parçaları / Spare Parts / Ersatzteile					
	DCON	HF	LF	WF		Altık Shim Unterlage	Sıkma Vidası Screw Schraube	Baskı Parçası Wedge Clamp Spannpratze	Baskı Vidası Clamp Screw Klemmschraube	Tork Anahtar Torx Key Torx-Schlüssel	
S22D PSDNN 12C	●	22	19.5	65	11						
						SNM. 1204..	AASN-20020	AEV-01-M6x16	ACK-05	4015-M4x11	AAL-02-2.5

R: Sağ / Right / Rechts L: Sol/Left/Links

● Stokta / In Stock / Auf Lager ○ Stokta Yok / Non Stock Item / Kein Lagerartikel, Lieferzeit auf Anfrage

Sipariş Örneği/Ordering Example/Bestellbeispiel
1 ad./pcs./stück S22D PSDNN 12C

KARTUŞLARIN YEDEK PARÇALARI
SPARE PARTS OF CARTRIDGE
ERSATZTEILE FÜR KURZDREHHALTER

Takım Kodu
Ordering Code
Bestell-Bezeichnung

Takım Kodu Ordering Code Bestell-Bezeichnung	Eksenel Ayar Vida Axial Adj. Screw Axial-Einstellschraube	Radyal Ayar Vida Radial Adj. Screw Radial-Einstellschraube	Radyal Ayar Vida Anahtar Radial Adj. Screw Allen Key Innensechskantschlüssel für Radial-Einstellschraube	Yedek Parçaları / Spare Parts / Ersatzteile		
				Montaj Vida Mounting Screw Befestigungsschraube	Montaj Vida Anahtar Mounting Screw Allen Key Innensechskantschlüssel für Befestigungsschraube	
SCFCR/L	06CA 06	2600-M4x9.5	2715-M3x5	AAL-09-1.5	AKV-23-M4x10	AAL-03-3
SCSCR/L	08CA 06	2600-M4x9.5	2715-M3x5	AAL-09-1.5	AKV-23-M4x10	AAL-03-3
SSKCR/L	10CA 09	2600-M5x13	2702-M4x10	AAL-01-2	2505-M6x16	AAL-03-3
	12CA 12	2600-M5x13	2702-M4x10	AAL-01-2	2505-M6x16	AAL-03-3
	16CA 12	2600-M6x18	2725-M5x12	AAL-02-2.5	2005-M8x25	AAL-07-5
STSCR/L	08CA 09	2600-M4x9.5	2715-M3x5	AAL-09-1.5	AKV-23-M4x10	AAL-03-3
STTCR/L	10CA 11	2600-M5x13	2702-M4x10	AAL-01-2	2505-M6x16	AAL-03-3
STFCR/L	12CA 16	2600-M5x13	2702-M4x10	AAL-01-2	2505-M6x16	AAL-03-3
	16CA 16	2600-M6x18	2725-M5x12	AAL-02-2.5	2005-M8x25	AAL-07-5
PTFNR/L	12CA 16	2600-M5x13	2702-M4x4	AAL-01-2	2505-M6x16	AAL-03-3
PSKNR/L	16CA 16	2600-M6x18	2725-M5x6	AAL-02-2.5	2005-M8x25	AAL-07-5
PSRNR/L	16CA 12	2600-M6x18	2725-M5x6	AAL-02-2.5	2005-M8x25	AAL-07-5



Takım Kodu Ordering Code Bestell-Bezeichnung	Stok Stock Lager	Ölçü Aralığı (mm) Boring Range (mm) Bohrbereich (mm)					Kartuşlar Cartridge Kurzdrehhalter	Gövde Takım Kodu Body Tool Code Grundkörper-Bezeichnung	Teknik Çizim Technical Draw Technische Zeichnung
		D max		D min		Max (D dış-D iç) (D out-D in)			
		D iç D in	D dış D out	D iç D in	D dış D out				
ACPBT-1	●	27-52	52	18-36	36	27	ÖTG-K-120-20		
ACPBT-2	●	27-49	52	25-36	36	27			
ACPBT-3	●	48-75	75	41	42	27			
ACPBT-4	●	51-75	75	51	52	27			
ACPBT-5	●	22-35	35	22	23	27			
ACPBT-6	●	15-35	35	15	16	27			
ACPBT-7	●	49-53	75	32-36	36	27			
ACPBT-8	●	49	75	33-37	37	27			

Takım Kodu Ordering Code Bestell-Bezeichnung	Stok Stock Lager	Ölçü Aralığı (mm) Boring Range (mm) Bohrbereich (mm)					Kartuşlar Cartridge Kurzdrehhalter	Gövde Takım Kodu Body Tool Code Grundkörper-Bezeichnung	Teknik Çizim Technical Draw Technische Zeichnung
		D1		D2		Max (D dış-D iç) (D out-D in)			
		D max	D min	D max	D min				
ACPBT-9	●	38	24	15	1	-	ÖTG-K-120-20		
ACPBT-10	●	78	64	43	29	-			

R: Sağ / Right / Rechts L: Sol/Left/Links

● Stokta / In Stock / Auf Lager ○ Stokta Yok / Non Stock Item / Kein Lagerartikel, Lieferzeit auf Anfrage



www.akko.com.tr

Sipariş Örneği/Ordering Example/Bestellbeispiel

1 ad./pcs./stück ACPBT-1

konusulan
the spoken *kalite...*
quality...





*konusulan
the spoken kalite...
quality...*

DİŞ AÇMA

DİŞ AÇMA TAKIMLARI
THREADING TOOLHOLDERS
GEWINDE DREHHALTER





S **E** **R** **25 25** **M** **16** **C**

1 Sıkma Tipi / Method of Mounting of Insert
 Klemmsystem

S: Vida Sıkmalı
 S: Screw Clamping / S Schrauben-Spannsystem
 T: Vida Sıkmalı Helis Açılı
 T: Screw Clamping with Helix Angle
 T: Schraubenklemmung für unterschiedliche Einstellwinkel

2 İşlem Tipi / Application
 Anwendung

E: Dış / External
 Außen
 I: İç/Internal / Internal
 Innen

3 Kesme Yönü
 Cutting Direction
 Halterausführung

R: Sağ Yan
 Right-Hand
 R: Rechts

L: Sol Yan
 Left-Hand
 L: Links

4 Takım Malzemesi / Type of Boring / Art der Bohrmaschine

"A" Yekpare çelik gövde soğutma suyu kanallı / "A" Solid steel with coolant hole
 "A" Stahlschaft mit Kühlbohrung SEITE 123
 "E" Çelik başlıkla sert metal gövde ve soğutma suyu kanallı / "E" Carbide bar with fixed steel head and coolant hole
 "E" Hartmetallschäfte mit festem Stahlkopf und Kühlmittelbohrung
 "C" Karbür Şaft / "C" Carbide shank / "C" Hartmetallschaft
 "S" Çelik Şaft / "S" Steel shank / "S" Stahlschaft

4-5 Dış Çap Şaft Ölçüleri
 External Shank Size
 Äußere Schaftgröße

Şaft / Shank / Schaftausführung: hxb
 2525 - 25 x 25 mm

5 Şaft Çapı / Shank Diameter
 Schaft-Durchmesser

6 Şaft Boyu / Shank Length / Schaftlänge

A - 32	H - 100	Q - 180	x-special
B - 40	J - 110	R - 200	
C - 50	K - 125	S - 250	
D - 60	L - 140	T - 300	
E - 70	M - 150	U - 350	
F - 80	N - 160	V - 400	
G - 90	P - 170	W - 450	

7 Elmas Ölçüsü / Insert Size
 Wendeplattengröße

l (mm)	d
06	5/32"
08	3/16"
11	1/4"
16	3/8"
22	1/2"
27	5/8"

8 Baskı Pabucu
 Wedge Clamp
 Spannpratze

S **I** **R** **S** **25** **R** **16** **C**

DIŞ ÇAP DIŞ AÇMA KATERLERİ
EXTERNAL THREADING TOOLHOLDERS
AUSSEN-GEWINDEDREHHALTER

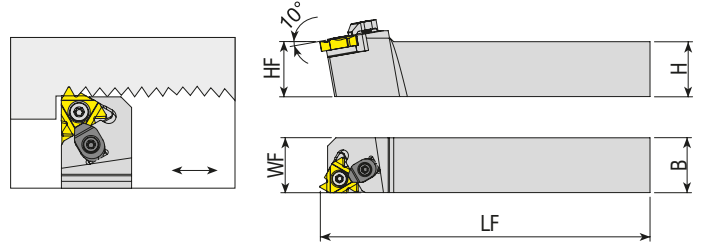

Takım Kodu Ordering Code Bestell-Bezeichnung	Stok Stock Lager		Takım Ölçüleri (mm) Dimension (mm) Abmessung (mm)				Kesici Uç Insert Wendeschneidplatte	Yedek Parçaları / Spare Parts / Ersatzteile					
	R	L	HF=H	B	LF	WF		Sıkma Vidası Screw Schraube	Altlık Shim Unterlage	Altlık Vidası Shim Screw Schraube für Unterlage	Baskı Parçası Wedge Clamp Spannpratze	Baskı Vidası Clamp Screw Klemmschraube	Tork Anahtar Torx Key
SER/L 0808 E11	●	●	08	08	70	11	11 ER/EL	4008-M2.5x6	-	-	-	-	80-T08
SER/L 1010 E11	●	●	10	10	70	11							
SER/L 1212 F11	●	●	12	12	80	12							
SER/L 1616 H11	●	●	16	16	100	16	16 ER/EL (0.35 - 3) ISO METRIC	4015-M3.5x14	AATN-2-0020	AAV-06-M3.5x11	-	-	80-T15
SER/L 1616 H16C	●	●	16	16	100	16							
SER/L 2020 K16C	●	●	20	20	125	20							
SER/L 2525 M16C	●	●	25	25	150	25	22 ER/EL (3.5 - 4.5) ISO METRIC	1020-M4.5x16	AATN-2-0004	AAV-07-M4.5x13	ACK-05	4015 M4x11	80-T20
SER/L 3232 P16C	●	●	32	32	170	32							
SER/L 2525 M22C	●	●	25	25	150	25							
SER/L 3232 P22C	●	●	32	32	170	32	16 ER/L (1.5-3 TR)	4015-M3.5x14	-	-	-	-	80-T15
SER/L 4040 S22C	●	●	40	40	250	40							
SER/L 2525 M16C-T	●	●	25	25	150	25							
SER/L 2525 M22C-T	●	●	25	25	150	25	22 ER/L (4-6 TR)	1020-M4.5x16	-	-	-	-	80-T20
SER/L 2020 K16C-S	●	●	20	20	125	25	SNDVK 166 ER/L16	4015-M3.5x14	AATN-2-0020	AAV-06-M3.5x11	-	-	80-T15
SER/L 2525 M16C-S	●	●	25	25	150	31							
SER/L 3232 P16C-S	●	●	32	32	170	38.5							

DIŞ ÇAP DIŞ AÇMA İSVİÇRE TİPİ KAYAR OTOMAT MAKİNA KATERLERİ
EXTERNAL THREADING TOOLHOLDERS FOR SWISS TYPE SLIDING AUTOMATIC LATHES
AUSSEN-GEWINDEDREHHALTER FÜR LANGDREHAUTOMATEN

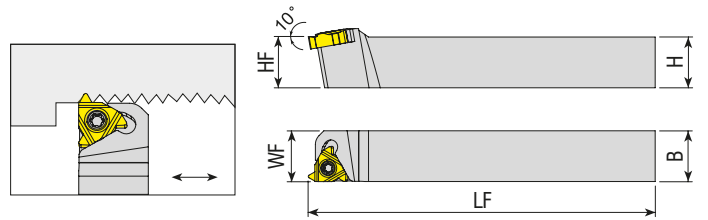

Takım Kodu Ordering Code Bestell-Bezeichnung	Stok Stock Lager		Takım Ölçüleri (mm) Dimension (mm) Abmessung (mm)				Kesici Uç Insert Wendeschneidplatte	Yedek Parçaları / Spare Parts / Ersatzteile					
	R	L	HF=H	B	LF	WF		Sıkma Vidası Screw Schraube	Altlık Shim Unterlage	Altlık Vidası Shim Screw Schraube für Unterlage	Baskı Parçası Wedge Clamp Spannpratze	Baskı Vidası Clamp Screw Klemmschraube	Tork Anahtar Torx Key
SER/L 1010 K11-S	●	●	10	10	125	10	11 ER/EL	4008-M2.5x6	-	-	-	-	80-T08
SER/L 1212 K11-S	●	●	12	12	125	12							

R: Sağ / Right / Rechts L: Sol/Left/Links ● Stokta / In Stock / Auf Lager ○ Stokta Yok / Non Stock Item / Kein Lagerartikel, Lieferzeit auf Anfrage
Takımlar standart 1.5° helis açılı olarak üretilir. / The tools have a built in 1.5° helix angle. / GEWINDE-DREHHALTER werden mit Einstellwinkel 1.5° hergestellt
UYARI / WARNING / ACHTUNG: Sayfa 130'deki B ve D figürleri uygulanamaz. / The operation for B and D on page 130 can not be applied. / S. 130: für Abbildung B und D: nicht verwenden

Sipariş Örneği/Ordering Example/Bestellbeispiel
1 ad./pcs./stück SER 0808 E11



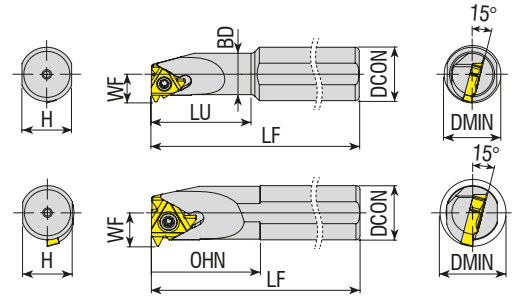
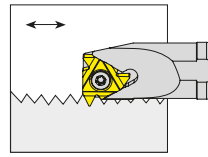

Takım Kodu
Ordering Code
Bestell-Bezeichnung

Stok Stock Lager	Takım Ölçüleri (mm) Dimension (mm) Abmessung (mm)							Kesici Uç Insert Wendeschneidplatte	Yedek Parçaları / Spare Parts / Ersatzteile						
	R	L	DCON	BD	LF	LU=OHN	WF		DMIN	Sıkma Vidası Screw Schraube	Aıtlık Shim Unterlage	Aıtlık Vidası Shim Screw Schraube für Unterlage	Baskı Parçası Wedge Clamp Spannpratze	Baskı Vidası Clamp Screw Klemmschraube	Tork Anahtar Torx Key Torx-Schlüssel
● ○			12	05	100	15	4.3	6.4			-	-	-	-	80-T06
● ●			16	07	150	18	5.3	7.8			-	-	-	-	80-T07
● ●			10	10	100	-	7.4	12			-	-	-	-	80-T08
● ●			12	12	125	-	8.4	16							
● ●			16	10	150	25	7.4	12							
● ●			16	13	150	32	8.9	15							
● ●			16	16	150	-	11.7	19							
● ●			16	13	150	32	10.2	16							
● ●			16	16	150	-	11.7	19							
● ●			20	16	170	40	11.7	19							
● ●			20	20	170	-	13.7	24							
● ●			25	25	200	-	16.2	29							
● ●			32	32	250	-	19.7	36		-	-	-	-	80-T15	
● ●			40	40	300	-	23.7	44							
● ●			50	50	350	-	28.7	54							
● ●			20	20	170	-	15.7	24							
● ●			25	25	200	-	18.1	29			-	-	-	-	80-T20
● ●			32	32	250	-	21.6	38							
● ●			40	40	300	-	25.6	46			-	-	-	-	80-T15
● ●			50	50	350	-	30.6	58							
● ●			25	25	200	-	16.2	29			-	-	-	-	80-T15
● ●			32	32	250	-	19.7	36							
● ●			25	25	200	-	18.1	29			-	-	-	-	80-T20
● ●			32	32	250	-	21.6	38							

R: Sağ / Right / Rechts L: Sol/Left/Links ● Stokta / In Stock / Auf Lager ○ Stokta Yok / Non Stock Item / Kein Lagerartikel, Lieferzeit auf Anfrage
Takımlar standart 1.5° helis açılı olarak üretilir. / The tools have a built in 1.5° helix angle. / GEWINDE-DREHHALTER werden mit Einstellwinkel 1.5° hergestellt
UYARI / WARNING / ACHTUNG: Sayfa 131'deki B ve D figürleri uygulanamaz. / The operation for B and D on page 131 can not be applied. / S.131: für Abbildung B und D: nicht verwenden

Sipariş Örneği/Ordering Example/Bestellbeispiel
1 ad./pcs./stück SIR S12X05H 06

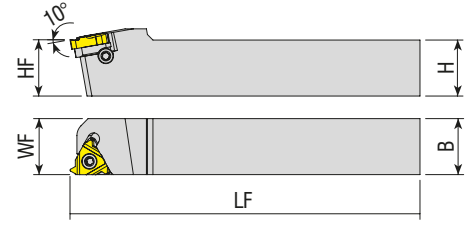
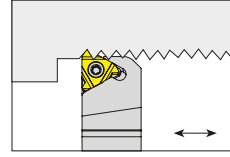
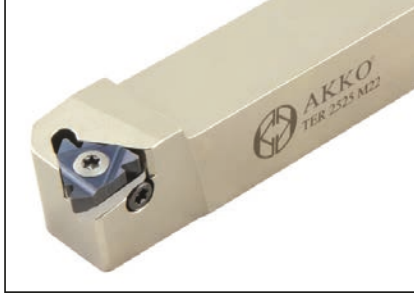

Takım Kodu Ordering Code Bestell-Bezeichnung	Stok Stock Lager		Takım Ölçüleri (mm) Dimension (mm) Abmessung (mm)				Kesici Uç Insert Wendeschneidplatte	Yedek Parçaları / Spare Parts / Ersatzteile					
	R	L	HF=H	B	LF	WF		Sıkma Vidası Screw Schraube	Sağ Altlık Right Shim U-Platte für WSP rechts	Sol Altlık Left Shim U-Platte für WSP links	Altık Vidası Shim Screw Schraube für Unterlage	Altık Vidası Pulu Shim Screw Ring Schraube für Unterlagerung	Tork Anahtar Torx Key Torx-Schlüssel
TER/L 1616 H16	●	●	16	16	100	16	16 ER/EL						
TER/L 2020 K16	●	●	20	20	125	20							
TER/L 2525 M16	●	●	25	25	150	25							
TER/L 3232 P16	●	●	32	32	170	32	22 ER/EL						
TER/L 2525 M22	●	●	25	25	150	25							
TER/L 3232 P22	●	●	32	32	170	32							
TER/L 4040 S22	●	●	40	40	250	40	27 ER/EL						
TER/L 2525 M27	●	●	25	25	150	25							
TER/L 3232 P27	●	●	32	32	170	32							
TER/L 4040 S27	●	●	40	40	250	40							

R: Sağ / Right / Rechts L: Sol/Left/Links ● Stokta / In Stock / Auf Lager ○ Stokta Yok / Non Stock Item / Kein Lagerartikel, Lieferzeit auf Anfrage
Takımlar standart 1.5° helis açılı olarak üretilir. / The tools have a built in 1.5° helix angle. / GEWINDE-DREHHALTER werden mit Einstellwinkel 1.5° hergestellt

Sipariş Örneği/Ordering Example/Bestellbeispiel
1 ad./pcs./stück TER 1616 H16

DIŞ ÇAP SAĞ YÖNDE VİDA AÇMA
EXTERNAL RIGHT HAND THREADING OPERATION
HERSTELLUNG VON AUBEN-RECHTSGEWİNDE

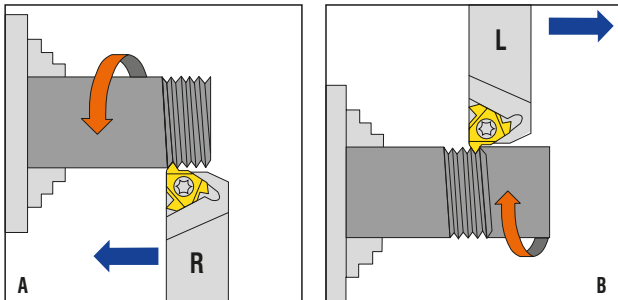

DIŞ ÇAP SOL YÖNDE VİDA AÇMA
EXTERNAL LEFT HAND THREADING OPERATION
HERSTELLUNG VON AUBEN-LINKSGEWİNDE

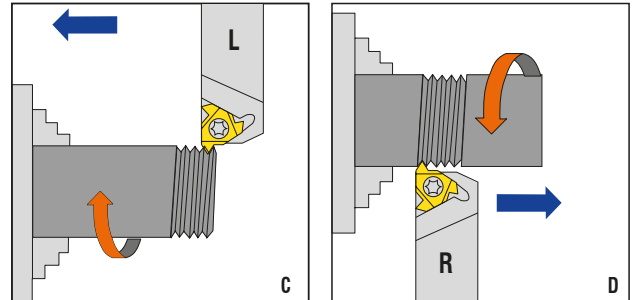

UYARI / WARNING / ACHTUNG

Figür B ve D için; negatif açılı altlık kullanılmalıdır. / For figure B and D; negative shim must be used. / Für Abbildung B und D; negative Unterlage verwenden.

Altiksız katerlerde B ve D figürü uygulanamaz. / B and D figures can not be applied on tools without shim. / Für Abbildung B und D; kann nicht mit Werkzeugen ohne Unterlegplatte erfolgen.

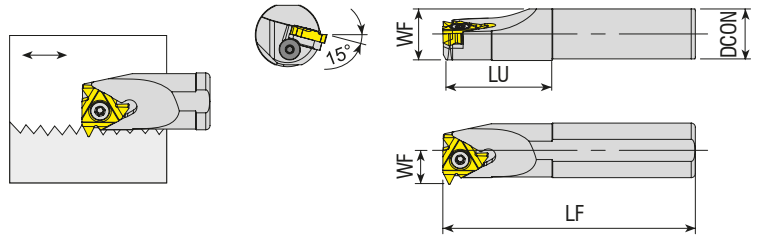

Takım Kodu Ordering Code Bestell-Bezeichnung	Stok Stock Lager		Takım Ölçüleri (mm) Dimension (mm) Abmessung (mm)					Kesici Uç Insert Wendeschneidplatte	Yedek Parçaları / Spare Parts / Ersatzteile						
	R	L	DCON	WF	LF	LU	WF		DMIN	Sıkma Vidası Screw Schraube	Sol Altılık Left Shim U-Platte für WSP links	Sağ Altılık Right Shim U-Platte für WSP rechts	Altılık Vidası Shim Screw Schraube für Unterlage	Altılık Vidası Pulu Shim Screw Ring Schraube für Unterlagering	Tork Anahtar Torx Key Torx-Schlüssel
TIR/L S25R 16	●	●	25	25	200	-	16.2	29	16 IR/L	1710-U5-40x12.2	ATS-16E	ATS-16I	AAV-11-U5-40x4.5	ABPL-03	80-T10
TIR/L S32S 16	●	●	32	32	250	-	19.7	36							
TIR/L S40T 16	●	●	40	40	300	-	23.7	44							
TIR/L S50U 16	●	●	50	50	350	-	28.7	54							
TIR/L S25R 22	●	●	25	25	200	-	18.1	29	22 IR/L	1720-U8-32x15	ATS-22E	ATS-22I	AAV-12-U8-32x5.5	ABPL-04	80-T20
TIR/L S32S 22	●	●	32	32	250	-	21.6	38							
TIR/L S40T 22	●	●	40	40	300	-	25.6	46							
TIR/L S50U 22	●	●	50	50	350	-	30.6	58							
TIR/L S32S 27	●	●	32	32	250	-	22.6	40	27 IR/L	1620-M5x18	ATS-27E	ATS-27I	AAV-15-M5x5.7	ABPL-05	80-T20
TIR/L S40T 27	●	●	40	40	300	-	26.6	48		1620-M5x22					
TIR/L S50U 27	●	●	50	50	350	-	31.6	58							

R: Sağ / Right / Rechts L: Sol/Left/Links ● Stokta / In Stock / Auf Lager ○ Stokta Yok / Non Stock Item / Kein Lagerartikel, Lieferzeit auf Anfrage
Takımlar standart 1.5° helis açılı olarak üretilir. / The tools have a built in 1.5° helix angle. / GEWINDE-DREHHALTER werden mit Einstellwinkel 1.5° hergestellt

Sipariş Örneği/Ordering Example/Bestellbeispiel
1 ad./pcs./stück TIR S25R 16

DELİK İÇİ SAĞ YÖNDE VIDA AÇMA
INTERNAL RIGHT HAND THREADING OPERATION
HERSTELLUNG VON INNEN-RECHTSGEWINDE

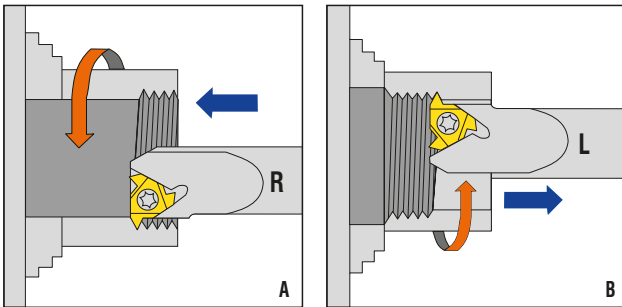

DELİK İÇİ SOL YÖNDE VIDA AÇMA
INTERNAL LEFT HAND THREADING OPERATION
HERSTELLUNG VON INNEN-LINKSGEWINDE

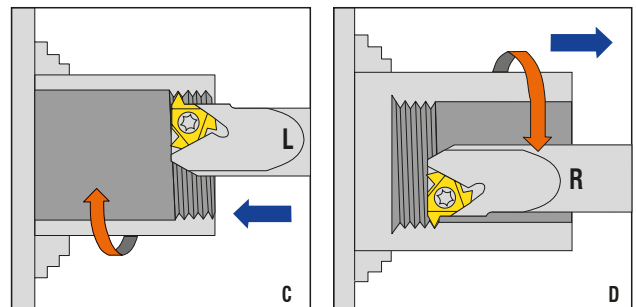

UYARI / WARNING / ACHTUNG

Figür B ve D için; negatif açılı altlık kullanılmalıdır. / For figure B and D; negative shim must be used. / Für Abbildung B und D; negative Unterlage verwenden.
Altıksız katerlerde B ve D figürü uygulanamaz. / B and D figures can not be applied on tools without shim. / Für Abbildung B und D; kann nicht mit Werkzeugen ohne Unterlegplatte erfolgen.

Diş Helis Açısı Thread Helix Angle Steigungswinkel

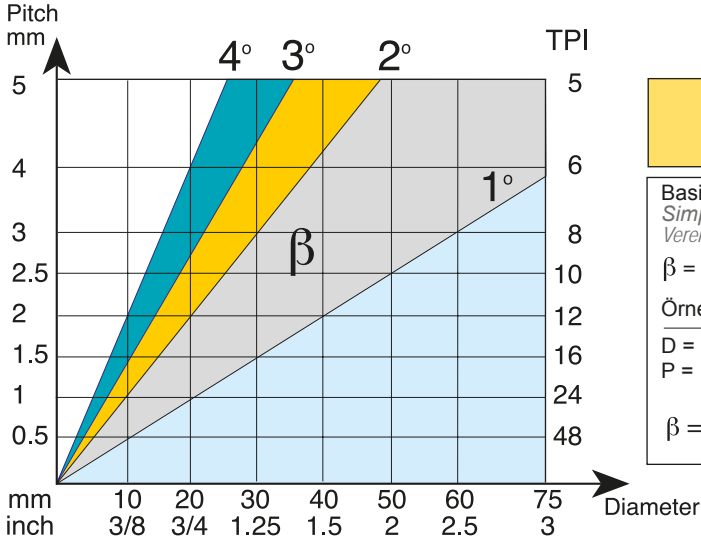

$$\tan \beta = \frac{P}{\pi \times D}$$

Basitleştirilmiş formül
 Simplified formula
 Vereinfachte Formel

$$\beta = 20 P/D$$

Örnek / Example / Beispiel :

$$D = 25 \text{ mm (0.98")}$$

$$P = 1.5 \text{ mm (16 TPI)}$$

$$\beta = \frac{25 \times 1.5}{40} = 1.25^\circ$$

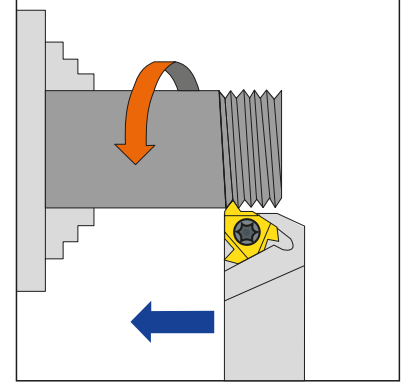

Standart ve Eğik Altlıklar Standard and Slanted Shim Standard und Schräge Unterlegplatte

Akko diş açma takımlarının, uç yuvaları 1.5° helis açılı olarak üretilir. Farklı helis açılı diş açmak isteyenler altlığı değiştirerek istedikleri dereceyi elde edebilirler. Negatif helis genellikle sol katerde sağ diş çekmek için kullanılır ya da sağ katerde sol diş çekmek için kullanılır.

Akko Toolholders Pockets have a built in 1.5° helix angle. This angle may be adjusted to better match the thread helix angle by simply changing the shim. Negative helix is usually used when threading RH thread with LH Holder or LH thread with RH Holder.

Die Akko-Gewindedrehhalter werden mit 1,5°-Steigungswinkel produziert. Durch Wechseln der Unterlage kann dieser Winkel dem optimalen Steigungswinkel angepasst werden. Die Unterlagen mit negativem Winkel werden eingesetzt, wenn ein Rechtsgewinde mit einem linken Halter oder ein Linksgewinde mit einem rechten Halter gefertigt werden soll.

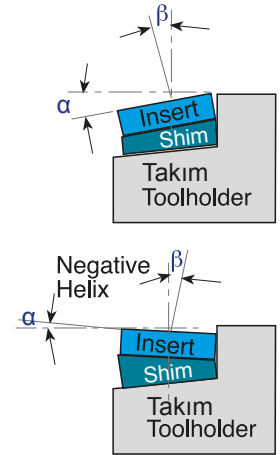

L	IC	Takım Tipi Tool Type Werkzeugtyp	Uç Yuvasının Açısı (α) / Pocket's Angle (α) / Winkel Wendeplattensitz (α)						
			4.5°	3.5°	2.5°	1.5°	0.5°	-0.5°	-1.5°
16	3/8	EX-RH or IN-LH	ATS-16E+4.5	ATS-16E+3.5	ATS-16E+2.5	ATS-16E	ATS-16E+0.5	ATS-16E-0.5	ATS-16E-1.5
16	3/8	EX-LH or IN-RH	ATS-16I+4.5	ATS-16I+3.5	ATS-16I+2.5	ATS-16I	ATS-16I+0.5	ATS-16I-0.5	ATS-16I-1.5
22	1/2	EX-RH or IN-LH	ATS-22E+4.5	ATS-22E+3.5	ATS-22E+2.5	ATS-22E	ATS-22E+0.5	ATS-22E-0.5	ATS-22E-1.5
22	1/2	EX-LH or IN-RH	ATS-22I+4.5	ATS-22I+3.5	ATS-22I+2.5	ATS-22I	ATS-22I+0.5	ATS-22I-0.5	ATS-22I-1.5
27	5/8	EX-RH or IN-LH	ATS-27E+4.5	ATS-27E+3.5	ATS-27E+2.5	ATS-27E	ATS-27E+0.5	ATS-27E-0.5	ATS-27E-1.5
27	5/8	EX-LH or IN-RH	ATS-27I+4.5	ATS-27I+3.5	ATS-27I+2.5	ATS-27I	ATS-27I+0.5	ATS-27I-0.5	ATS-27I-1.5

Altlık Değişirme Öneri Tablosu / Shim Change Recommendation Empfehlungen zum Wechseln der Unterlage

Tabloda da görüldüğü gibi bazı diş hatvelerinin çaplara göre kombinasyonları altlık değişimini gerektirir. Eğer değişim gerekli ise EX-RH ve IN-LH katerleri için ATS-E altlıklarını, IN-RH ve EX-LH katerleri için ATS-I altlıklarını kullanın.

As can be seen from the chart, some Pitch to Diameter combinations require a shim change. If change is required, use ATS-E shim for EX-RH and IN-LH toolholders and ATS-I shims for IN-RH and EX-LH toolholders.

Wie aus der Tabelle ersichtlich, erfordern einige Steigung-Durchmesser-Kombinationen einen Wechsel der Unterlage. In diesem Fall wird eine ATS-E-Unterlage auf einem rechten Außenhalter bzw. einem linken Innenhalter eingesetzt. Die ATS-I-Unterlage kommt bei einem rechten Innenhalter bzw. einem linken Außenhalter zum Einsatz.

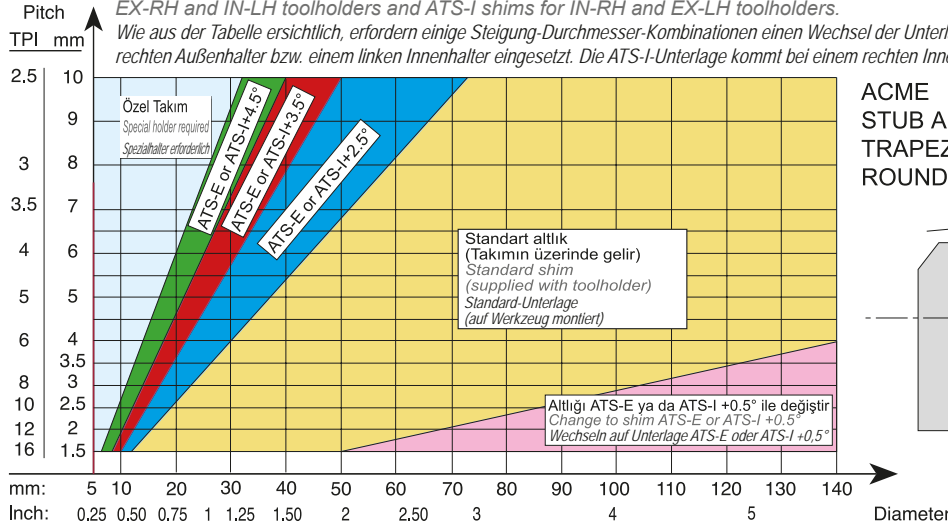

ACME
 STUB ACME
 TRAPEZ (DIN 103)
 ROUND (DIN 405)

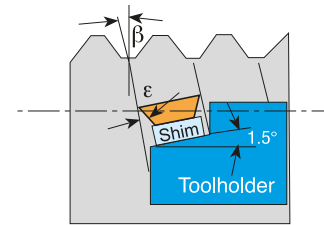

Tabloda da görüldüğü gibi çoğu uygulamalar altlık değişimine ihtiyaç duymaz. Eğer değişime ihtiyaç duyulursa EX-RH ve IN-LH katerleri için ATS-E altlıklarını, IN-RH ve EX-RH katerleri için ATS-I altlıklarını kullanın.

As can be seen from the chart, most applications do not require a shim change. If change is required, use ATS-E shims for EX-RH and IN-LH toolholders and ATS-I shims for IN-RH and EX-LH toolholders.

Wie aus der Tabelle ersichtlich, erfordern einige Steigung-Durchmesser-Kombinationen einen Wechsel der Unterlage. In diesem Fall wird eine ATS-E-Unterlage auf einem rechten Außenhalter bzw. einem linken Innenhalter eingesetzt. Die ATS-I-Unterlage kommt bei einem rechten Innenhalter bzw. einem linken Außenhalter zum Einsatz.

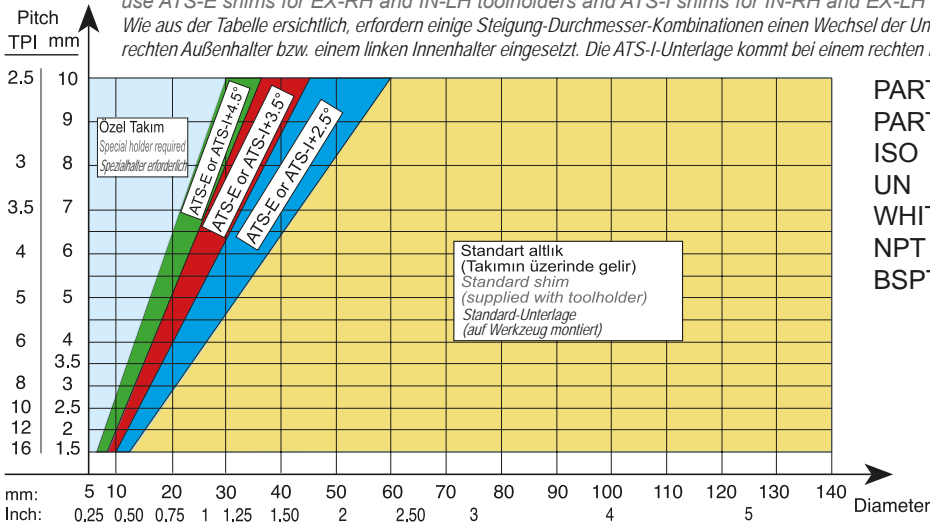

PARTIAL PROFILES 60°
 PARTIAL PROFILES 55°
 ISO
 UN
 WHIT.
 NPT
 BSPT

Tabloda da görüldüğü gibi çoğu uygulamalar altlık değişimine ihtiyaç duyar. Çoğu durumda negatif bir altlığı ihtiyaç duyulur. EX-RH ve IN-LH takımlar için ATS-E altlıklarını kullanın. IN-RH ve EX-LH takımlar için ATS-I altlıklarını kullanın.

As can be seen from the chart, most applications require a shim change. In most cases a negative shim is required, use ATS-E shims for EX-RH and IN-LH toolholders. ATS-I shims for IN-RH and EX-LH toolholders.

Wie aus der Tabelle ersichtlich, erfordern einige Steigung-Durchmesser-Kombinationen einen Wechsel der Unterlage. In diesem Fall wird eine ATS-E-Unterlage auf einem rechten Außenhalter bzw. einem linken Innenhalter eingesetzt. Die ATS-I-Unterlage kommt bei einem rechten Innenhalter bzw. einem linken Außenhalter zum Einsatz.

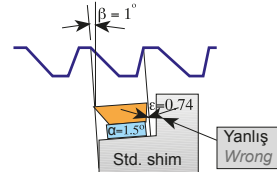
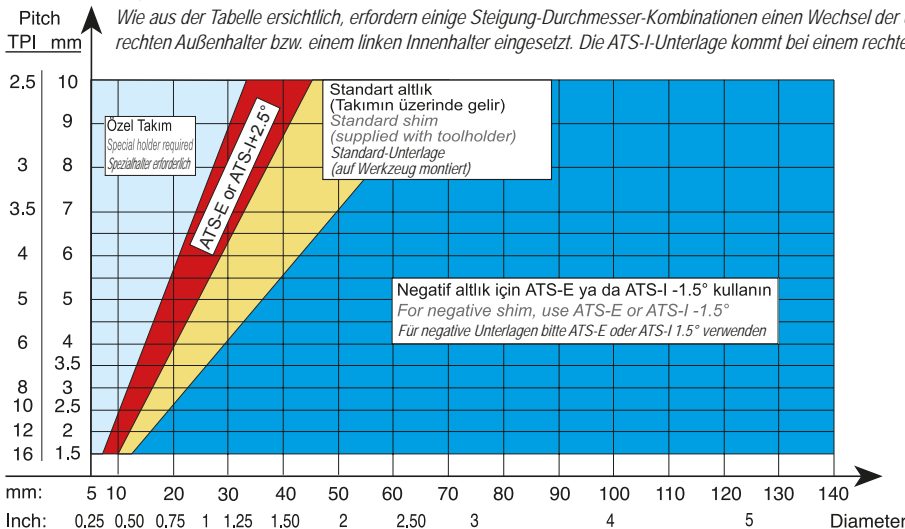

Before Shim Change
 Altlığı Değiştirmeden Önce
 vor dem Wechseln der Unterlegplatte

AMERICAN
 BUTTRESS
 SAGENGEWINDE
 (DIN 513)

Standart altlığın negatif bir altlıkla değiştirilmesi, kenar sürtmesini engelleyecektir.

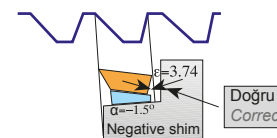

After Shim Change
 Altlığı Değiştirdikten Sonra
 Nach dem Wechseln der Unterlegplatte

Replacing the standard shim with a shim has negative angle, will eliminate side rubbing

Das Ersetzen der Standard-Unterlegplatte durch eine Unterlegplatte mit negativem Winkel verhindert seitliche Reibung.



konusulan
the spoken kalite...
quality...

KANAL AÇMA

KANAL AÇMA TAKIMLARI
GROOVING TOOLHOLDERS
STECHHALTER



AKKO **A** **AKT** - **K** - **R** - **2525**

100 - 150 - **4** - **T22**

2 Kesici Stili / Cutter Style / Cutter-Stil

DKT: Dış Çap Kanal Açma Takımı / External Grooving Toolholders
Außen-Stechhalter
IKT: Delik İçi Kanal Açma Takımı / Internal Grooving Toolholders
Innen-Stechhalter
AKT: Dış Çap Alın Kanal Takımları / Face Grooving Toolholders
Axial-Stechhalter
LKT: L Tip Alın Kanal Açma Takımı / L Type Face Grooving Toolholders
Axial-Stechhalter L-Type

3 Uç Tipi / Insert Type / Plattenform

KRLY / MGM.
HRN / S312, S229, S224, S223
ISCR / DGN, GI, GTN
SNDVK / 123, 151, 154.91
ZCC
KM / A4.
ARN / LOMR.

TGTC / TD.

4 Kesme Yönü / Cutting Direction
Halteausführung

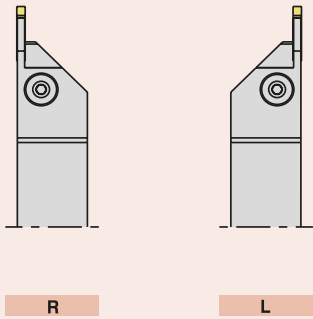

5 Kesme Kenar Yüksekliği ve Şaft Genişliği
Cutting Edge Height and Shank Width
Schafthöhe und Schafbreite

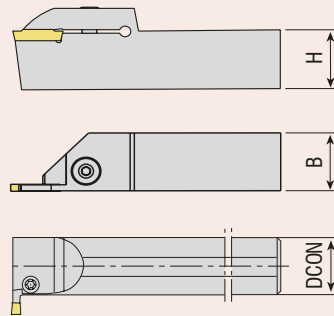

6 Kesme Aralığı
Cutting Diameter
Durchmesser für Axialeinstechen

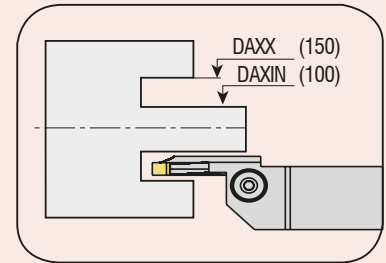

7 Kesme Kenar Genişliği / Cutting Width Edge
Plattenbreite

ÖR/E.G. :
2 = 2.0 mm
3 = 3.0 mm
4 = 4.0 mm
5 = 5.0 mm
6 = 6.0 mm
8 = 8.0 mm

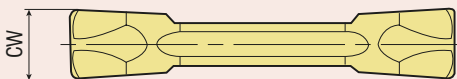

8 Kesme Derinliği / Cutting Depth / Maximale Schnitttiefe

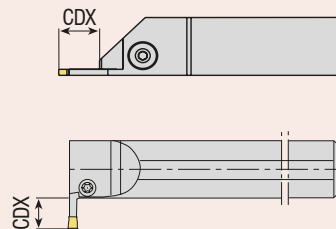

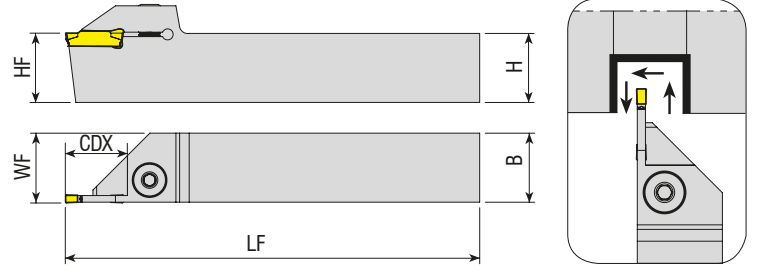

Takım Kodu Ordering Code Bestell-Bezeichnung	Stok Stock Lager		Takım Ölçüleri (mm) Dimension (mm) Abmessung (mm)				Kesici Uç Insert Wendeschneidplatte	Yedek Parçaları / Spare Parts / Ersatzteile			
	R	L	HF=H	B	LF	WF		CDX	Sıkma Vidası Screw Schraube	Pul Stamp Ring	Anahtar Allen Key Inmenschenschlüssel
ADKT-K-R/L-1212-1.5-T15	●	●	12	12	100	12.2	15	MGM. - 1.5	AKV-02-M6x22	ABPL-01	AAL-03-3
ADKT-K-R/L-2020-1.5-T15	●	●	20	20	125	20.2	15				
ADKT-K-R/L-1212-2-T15	●	●	12	12	100	16.3	15				
ADKT-K-R/L-1616-2-T15	●	●	16	16	125	16.3	15	MGM. - 2	AKV-02-M6x22	ABPL-01	AAL-03-3
ADKT-K-R/L-2020-2-T15	●	●	20	20	125	20.3	15				
ADKT-K-R/L-2525-2-T15	●	●	25	25	150	25.3	15				
ADKT-K-R/L-3232-2-T15	●	●	32	32	170	32.3	15	MGM. - 3	AKV-02-M6x22	ABPL-01	AAL-03-3
ADKT-K-R/L-1212-3-T15	●	●	12	12	100	16.3	15				
ADKT-K-R/L-1616-3-T15	●	●	16	16	125	16.4	15				
ADKT-K-R/L-2020-3-T20	●	●	20	20	125	20.4	20	MGM. - 3	AKV-02-M6x22	ABPL-01	AAL-03-3
ADKT-K-R/L-2020-3-R28	●	●	20	20	125	20.3	28				
ADKT-K-R/L-2525-3-R15	●	●	25	25	150	25.4	15				
ADKT-K-R/L-2525-3-T22	●	●	25	25	150	25.4	22	MGM. - 3	AKV-02-M6x22	ABPL-01	AAL-03-3
ADKT-K-R/L-3232-3-T22	●	●	32	32	170	32.4	22				
ADKT-K-R/L-2020-4-T20	●	●	20	20	125	20.4	20				
ADKT-K-R/L-2020-4-R25	●	○	20	20	125	20.4	25	MGM. - 4	2004-M8x1x20	-	AAL-05-4
ADKT-K-R/L-2525-4-T18	●	●	25	25	150	25.4	18				
ADKT-K-R/L-2525-4-T22	●	●	25	25	150	25.4	22				
ADKT-K-R/L-3232-4-T22	●	●	32	32	170	32.4	22	MGM. - 4	2004-M8x1x20	-	AAL-05-4
ADKT-K-R/L-2020-5-T20	●	●	20	20	125	20.5	20				
ADKT-K-R/L-2525-5-T18	●	●	25	25	150	25.5	18				
ADKT-K-R/L-2525-5-T25	●	●	25	25	150	25.5	25	MGM. - 5	2004-M8x1x20	-	AAL-05-4
ADKT-K-R/L-3232-5-T25	●	●	32	32	170	32.5	25				
ADKT-K-R/L-2525-6-T25	●	●	25	25	150	25.6	25				
ADKT-K-R/L-3232-6-T25	●	●	32	32	170	32.6	25	MGM. - 6	2004-M8x1x20	-	AAL-05-4
ADKT-K-R/L-3232-8-T32	●	●	32	32	170	32.8	32				

R: Sağ / Right / Rechts L: Sol/Left/Links

● Stokta / In Stock / Auf Lager ○ Stokta Yok / Non Stock Item / Kein Lagerartikel, Lieferzeit auf Anfrage

KRLY - JD Ucuna Uygunudur. / Compatible with KRLY - JD Insert. / Kompatibel mit KRLY - JD Wendeplatten

Sipariş Örneği/Ordering Example/Bestellbeispiel

1 ad./pcs./stück ADKT-K-R-1212-2-T15

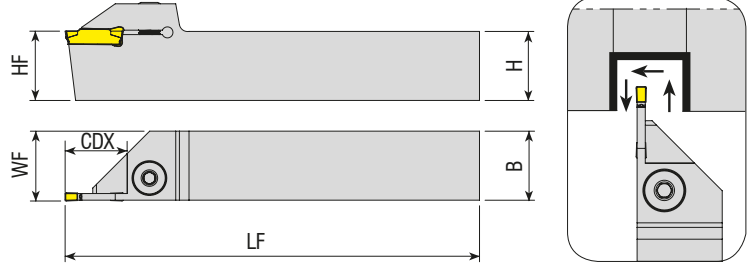

Takım Kodu Ordering Code Bestell-Bezeichnung	Stok Stock Lager		Takım Ölçüleri (mm) Dimension (mm) Abmessung (mm)					Kesici Uç Insert Wendeschneidplatte	Yedek Parçaları / Spare Parts / Ersatzteile		
	R	L	HF=H	B	LF	WF	CDX		Sıkma Vidası Screw Schraube	Pul Stamp Ring	Anahtar Allen Key Innensechskantschlüssel
ADKT-KG-R/L-2020-2-T15	●	●	20	20	125	20.2	15	KG.. - 2	AKV-02-M6x22	ABPL-01	AAL-03-3
ADKT-KG-R/L-2525-2-T15	●	○	25	25	150	25.2	15				
ADKT-KG-R/L-2525-2-T17	●	○	25	25	150	25.2	17	KG.. - 3	2004-M8x1x20	-	AAL-05-4
ADKT-KG-R/L-1616-3-T20	●	●	16	16	125	16.3	20				
ADKT-KG-R/L-2020-3-T20	●	●	20	20	125	20.3	20	KG.. - 4	2004-M8x1x20	-	AAL-05-4
ADKT-KG-R/L-2525-3-T22	●	●	25	25	150	25.3	22				
ADKT-KG-R/L-2020-4-T20	●	●	20	20	125	20.4	20	KG.. - 5	2004-M8x1x20	-	AAL-05-4
ADKT-KG-R/L-2525-4-T16	●	○	25	25	150	25.4	16				
ADKT-KG-R/L-2525-4-T22	●	○	25	25	150	25.4	22	KG.. - 6	2004-M8x1x20	-	AAL-05-4
ADKT-KG-R/L-2525-5-T25	●	○	25	25	150	25.5	25				
ADKT-KG-R/L-2525-6-T25	○	○	25	25	150	25.6	25				

KRLY Ucuna Uygun. / Compatible with KRLY Insert. / Kompatibel mit KRLY Wendeplatten

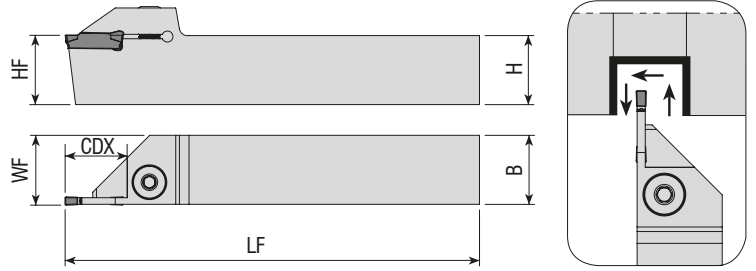

Takım Kodu Ordering Code Bestell-Bezeichnung	Stok Stock Lager		Takım Ölçüleri (mm) Dimension (mm) Abmessung (mm)					Kesici Uç Insert Wendeschneidplatte	Yedek Parçaları / Spare Parts / Ersatzteile		
	R	L	HF=H	B	LF	WF	CDX		Sıkma Vidası Screw Schraube	Pul Stamp Ring	Anahtar Allen Key Innensechskantschlüssel
ADKT-SGC-R/L-1212-2-R15	●	●	12	12	100	16.2	15	GCM N20	AKV-02-M6x22	ABPL-01	AAL-03-3
ADKT-SGC-R/L-1616-2-R15	●	●	16	16	125	16.2	15				
ADKT-SGC-R/L-2020-2-R20	●	●	20	20	125	20.2	20	GCM N30	2004-M8x1x20	-	AAL-05-4
ADKT-SGC-R/L-2525-2-R20	●	●	25	25	150	25.2	20				
ADKT-SGC-R/L-1212-3-R15	●	●	12	12	100	16.3	15	GCM N40	2004-M8x1x20	-	AAL-05-4
ADKT-SGC-R/L-1616-3-R15	●	●	16	16	125	16.3	15				
ADKT-SGC-R/L-2020-3-R22	●	●	20	20	125	20.3	22	GCM N40	2004-M8x1x20	-	AAL-05-4
ADKT-SGC-R/L-2525-3-R15	●	○	25	25	150	25.3	15				
ADKT-SGC-R/L-2525-3-R22	●	●	25	25	150	25.3	22	GCM N40	2004-M8x1x20	-	AAL-05-4
ADKT-SGC-R/L-2525-4-R25	●	○	25	25	150	25.4	25				

R: Sağ / Right / Rechts L: Sol/Left/Links

● Stokta / In Stock / Auf Lager ○ Stokta Yok / Non Stock Item / Kein Lagerartikel, Lieferzeit auf Anfrage
SMTM Ucuna Uygun. / Compatible with SMTM Insert. / Kompatibel mit SMTM Wendeplatten

Sipariş Örneği/Ordering Example/Bestellbeispiel
1 ad./pcs./stück ADKT-KG-R-2020-2-T15

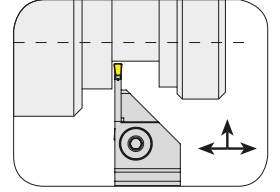
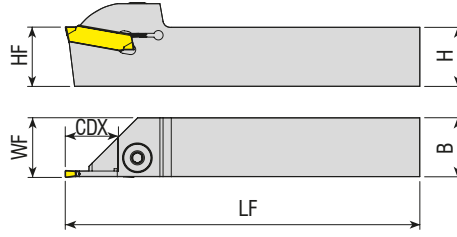

Takım Kodu Ordering Code Bestell-Bezeichnung	Stok Stock Lager		Takım Ölçüleri (mm) Dimension (mm) Abmessung (mm)				Kesici Uç Insert Wendeschneidplatte	Yedek Parçaları / Spare Parts / Ersatzteile			
	R	L	HF=H	B	LF	WF		CDX	Sıkma Vidası Screw Schraube	Pul Stamp Ring	Anahtar Allen Key Innerschloßschlüssel
ADKT-H-R/L-2020-3-T20	●	●	20	20	125	20.5	20	S229 - 3	2004-M8x1x20	-	AAL-05-4
ADKT-H-R/L-2525-3-T22	●	●	25	25	150	25.5	22				
ADKT-H-R/L-2525-3-T26	●	●	25	25	150	25.5	26				
ADKT-H-R/L-2020-4-T20	●	●	20	20	125	20.5	20	S229 - 4	2004-M8x1x20	-	AAL-05-4
ADKT-H-R/L-2525-4-T22	●	●	25	25	150	25.5	22				
ADKT-H-R/L-3232-4-T22	●	●	32	32	170	32.5	22				
ADKT-H-R/L-2020-5-T20	●	●	20	20	125	20.5	20	S229 - 5	2004-M8x1x20	-	AAL-05-4
ADKT-H-R/L-2525-5-T25	●	●	25	25	150	25.5	25				
ADKT-H-R/L-2525-6-T25	●	●	25	25	150	25.6	25				

HRN Ucuna Uygun. / Compatible with HRN Insert. / Kompatibel mit HRN Wendeplatten.

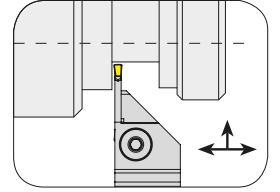
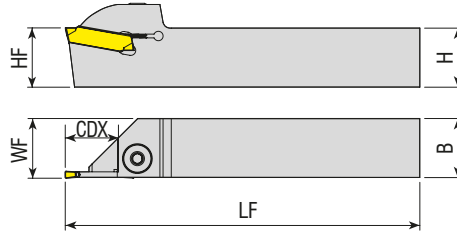

Takım Kodu Ordering Code Bestell-Bezeichnung	Stok Stock Lager		Takım Ölçüleri (mm) Dimension (mm) Abmessung (mm)				Kesici Uç Insert Wendeschneidplatte	Yedek Parçaları / Spare Parts / Ersatzteile			
	R	L	HF=H	B	LF	WF		CDX	Sıkma Vidası Screw Schraube	Pul Stamp Ring	Anahtar Allen Key Innerschloßschlüssel
ADKT-HK-R/L-1616-2-T15	●	●	16	16	125	16.3	15	S224 - 2	AKV-02-M6x22	ABPL-01	AAL-03-3
ADKT-HK-R/L-2020-2-T15	●	●	20	20	125	20.3	15				
ADKT-HK-R/L-2525-2-T15	●	●	25	25	150	25.3	15				
ADKT-HK-R/L-1616-3-T15	○	○	16	16	125	16.3	15	S224 - 3	2004-M8x1x20	-	AAL-05-4
ADKT-HK-R/L-2020-3-T20	●	●	20	20	125	20.4	20				
ADKT-HK-R/L-2525-3-T22	●	●	25	25	150	25.4	22				
ADKT-HK-R/L-2020-4-T20	●	●	20	20	125	20.4	20	S224 - 4	2004-M8x1x20	-	AAL-05-4
ADKT-HK-R/L-2525-4-T22	●	●	25	25	150	25.4	22				
ADKT-HS223-R/L-2020-2-T15	●	○	20	20	125	20.4	15	S223 - 2	AKV-02-M6x22	ABPL-01	AAL-03-3
ADKT-HS223-R/L-2020-3-T17	●	○	20	20	125	20.3	17	S223 - 3	2004-M8x1x20	-	AAL-05-4

R: Sağ / Right / Rechts L: Sol/Left/Links

● Stokta / In Stock / Auf Lager ○ Stokta Yok / Non Stock Item / Kein Lagerartikel, Lieferzeit auf Anfrage

HRN Ucuna Uygun. / Compatible with HRN Insert. / Kompatibel mit HRN Wendeplatten.

Sipariş Örneği/Ordering Example/Bestellbeispiel

1 ad./pcs./stück ADKT-H-R-2020-3-T20

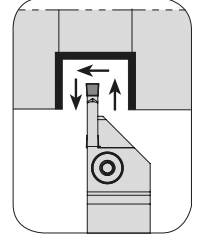
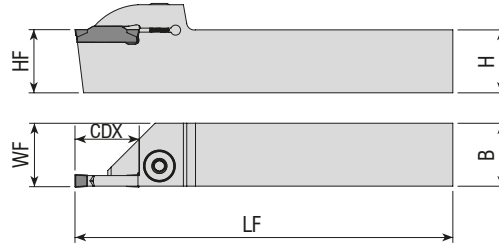

Takım Kodu Ordering Code Bestell-Bezeichnung	Stok Stock Lager		Takım Ölçüleri (mm) Dimension (mm) Abmessung (mm)					Kesici Uç Insert Wendeschneidplatte	Yedek Parçaları / Spare Parts / Ersatzteile		
	R	L	HF=H	B	LF	WF	CDX		Sıkma Vidası Screw Schraube	Pul Stamp Ring	Anahtar Allen Key Innensechskantschlüssel
ADKT-ZCC2-R/L-1616-2-T15	●	●	16	16	125	16.3	15	Z.BD - 2	AKV-02-M6x22	ABPL-01	AAL-03-3
ADKT-ZCC2-R/L-2020-2-T15	●	●	20	20	125	20.3	15				
ADKT-ZCC2-R/L-2525-2-T15	●	●	25	25	150	25.3	15				
ADKT-ZCC2-R/L-1616-2.5-T15	●	●	16	16	125	16.3	15	Z.ED - 2.5	2004-M8x1x20	-	AAL-05-4
ADKT-ZCC2-R/L-2020-2.5-T17	●	●	20	20	125	20.3	17				
ADKT-ZCC2-R/L-2525-2.5-T15	●	●	25	25	150	25.3	15				
ADKT-ZCC2-R/L-1616-3-T15	●	●	16	16	125	16.3	15	Z.FD - 3	2004-M8x1x20	-	AAL-05-4
ADKT-ZCC2-R/L-1616-3-T17	●	○	16	16	125	16.3	17				
ADKT-ZCC2-R/L-1616-3-T20	●	○	16	16	125	16.3	20				
ADKT-ZCC2-R/L-2020-3-T12	●	●	20	20	125	20.3	12	Z.GD - 4	2004-M8x1x20	-	AAL-05-4
ADKT-ZCC2-R/L-2020-3-T20	●	●	20	20	125	20.3	20				
ADKT-ZCC2-R/L-2020-3-R21	●	○	20	20	125	20.3	21				
ADKT-ZCC2-R/L-2020-3-R25	●	●	20	20	125	20.3	25	Z.HD - 5	2004-M8x1x20	-	AAL-05-4
ADKT-ZCC2-R/L-2525-3-T12	●	○	25	25	150	25.3	12				
ADKT-ZCC2-R/L-2525-3-T22	●	●	25	25	150	25.3	22				
ADKT-ZCC2-R/L-2525-3-R30	●	●	25	25	150	25.3	30	Z.KD - 6	2004-M8x1x20	-	AAL-05-4
ADKT-ZCC2-R/L-2020-4-T12	●	○	20	20	125	20.5	12				
ADKT-ZCC2-R/L-2020-4-T20	●	●	20	20	125	20.5	20				
ADKT-ZCC2-R/L-2525-4-T12	●	●	25	25	150	25.5	12	Z.HD - 5	2004-M8x1x20	-	AAL-05-4
ADKT-ZCC2-R/L-2525-4-T22	●	●	25	25	150	25.5	22				
ADKT-ZCC2-R/L-2020-5-T12	●	○	20	20	125	20.5	12				
ADKT-ZCC2-R/L-2020-5-T20	●	●	20	20	125	20.5	20	Z.KD - 6	2004-M8x1x20	-	AAL-05-4
ADKT-ZCC2-R/L-2525-5-T12	●	○	25	25	150	25.5	12				
ADKT-ZCC2-R/L-2525-5-T25	●	●	25	25	150	25.5	25				
ADKT-ZCC2-R/L-3232-5-T25	●	●	32	32	170	32.4	25	Z.KD - 6	2004-M8x1x20	-	AAL-05-4
ADKT-ZCC2-R/L-2020-6-T20	●	●	20	20	125	20.6	20				
ADKT-ZCC2-R/L-2525-6-T25	●	●	25	25	150	25.6	25				
ADKT-ZCC2-R/L-3232-6-T25	●	●	32	32	170	32.6	25	Z.KD - 6	2004-M8x1x20	-	AAL-05-4
ADKT-ZCC2-R/L-3232-6-T30	●	●	32	32	170	32.6	30				

R: Sağ / Right / Rechts L: Sol/Left/Links
● Stokta / In Stock / Auf Lager ○ Stokta Yok / Non Stock Item / Kein Lagerartikel, Lieferzeit auf Anfrage
ZCC Ucuna Uygunudur. / Compatible with ZCC Insert. / Kompatibel mit ZCC Wendeplatten.

Sipariş Örneği/Ordering Example/Bestellbeispiel
1 ad./pcs./stück ADKT-ZCC2-R-1616-2-T15

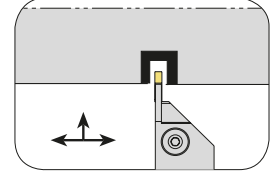
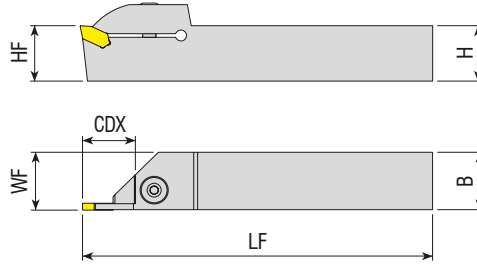

Takım Kodu Ordering Code Bestell-Bezeichnung	Stok Stock Lager		Takım Ölçüleri (mm) Dimension (mm) Abmessung (mm)				Kesici Uç Insert Wendeschneidplatte	Yedek Parçaları / Spare Parts / Ersatzteile			
	R	L	HF=H	B	LF	WF		CDX	Sıkma Vidası Screw Schraube	Pul Stamp Ring	Anahtar Allen Key Innerschlüssel
ADKT-ZCC1-R/L-2020-3-T20	●	○	20	20	125	20.3	20	ZQMX - 3	2004-M8x1x20	-	AAL-05-4
ADKT-ZCC1-R/L-2525-3-T22	●	○	25	25	150	25.3	22				
ADKT-ZCC1-R/L-2020-4-T20	●	○	20	20	125	20.4	20	ZQMX - 4	2004-M8x1x20	-	AAL-05-4
ADKT-ZCC1-R/L-2525-4-T22	●	○	25	25	150	25.4	22				

ZCC Ucuna Uygundur. / Compatible with ZCC Insert. / Kompatibel mit ZCC Wendeplatten.

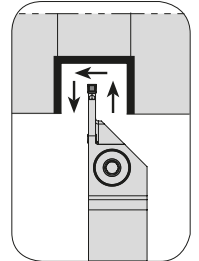
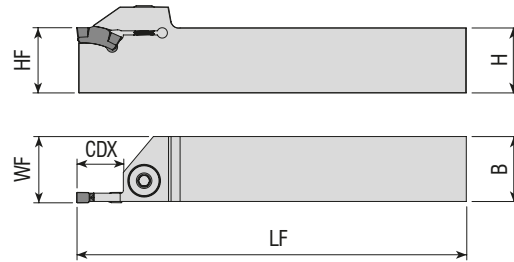

Takım Kodu Ordering Code Bestell-Bezeichnung	Stok Stock Lager		Takım Ölçüleri (mm) Dimension (mm) Abmessung (mm)				Kesici Uç Insert Wendeschneidplatte	Yedek Parçaları / Spare Parts / Ersatzteile			
	R	L	HF=H	B	LF	WF		CDX	Sıkma Vidası Screw Schraube	Pul Stamp Ring	Anahtar Allen Key Innerschlüssel
ADKT-ITG-R/L-2020-3-T8	●	●	20	20	125	20.3	8	TGM. - 3	2004-M8x1x20	-	AAL-05-4
ADKT-ITG-R/L-2525-3-T8	●	●	25	25	150	25.3	8				
ADKT-ITG-R/L-3232-3-T8	●	○	32	32	170	32.3	8	TGM. - 4	2004-M8x1x20	-	AAL-05-4
ADKT-ITG-R/L-2020-4-T9	●	●	20	20	125	20.4	9				
ADKT-ITG-R/L-2525-4-T17	●	●	25	25	150	25.4	17	TGM. - 5	2004-M8x1x20	-	AAL-05-4
ADKT-ITG-R/L-3232-4-T17	●	●	32	32	170	32.4	17				
ADKT-ITG-R/L-3232-5-T25	●	○	32	32	170	32.5	25				

R: Sağ / Right / Rechts L: Sol/Left/Links

● Stokta / In Stock / Auf Lager ○ Stokta Yok / Non Stock Item / Kein Lagerartikel, Lieferzeit auf Anfrage

ISCR Ucuna Uygundur. / Compatible with ISCR Insert. / Kompatibel mit ISCR Wendeplatten.

Sipariş Örneği/Ordering Example/Bestellbeispiel

1 ad./pcs./stück ADKT-ZCC1-R-2020-3-T20

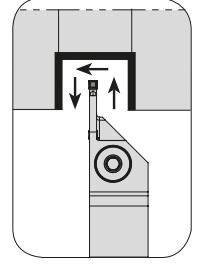
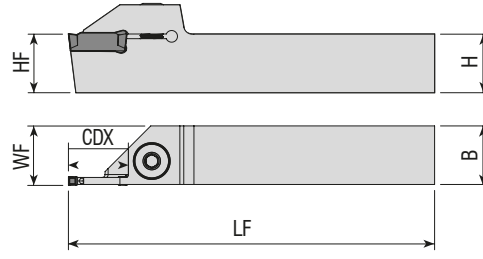

Takım Kodu Ordering Code Bestell-Bezeichnung	Stok Stock Lager		Takım Ölçüleri (mm) Dimension (mm) Abmessung (mm)					Kesici Uç Insert Wendeschneidplatte	Yedek Parçaları / Spare Parts / Ersatzteile			
	R	L	HF=H	B	LF	WF	CDX		Sıkma Vidası Screw Schraube	Pul Stamp Ring	Anahtar Allen Key Innensechskantschlüssel	
ADKT-I-R/L-1212-2-T15	●	●	12	12	125	16.3	15	DGN - 2	AKV-02-M6x22	ABPL-01	AAL-03-3	
ADKT-I-R/L-1616-2-T15	●	●	16	16	100	16.3	15					
ADKT-I-R/L-2020-2-T15	●	●	20	20	125	20.3	15					
ADKT-I-R/L-2525-2-T15	●	●	25	25	150	25.3	15					
ADKT-I-R/L-3232-2-T15	●	●	32	32	170	32.3	15					
ADKT-I-R/L-1212-3-T15	●	●	12	12	100	16.3	15	DGN - 3				
ADKT-I-R/L-1616-3-T15	●	●	16	16	125	16.4	15					
ADKT-I-R/L-2020-3-T20	●	●	20	20	125	20.4	20					
ADKT-I-R/L-2525-3-T22	●	●	25	25	150	25.4	22					
ADKT-I-R/L-3232-3-T22	●	●	32	32	170	32.4	22					
ADKT-I-R/L-2020-4-T20	●	●	20	20	125	20.4	20	DGN / GRP - 4	2004-M8x1x20	-	AAL-05-4	
ADKT-I-R/L-2525-4-T22	●	●	25	25	150	25.4	22					
ADKT-I-R/L-3232-4-T25	●	●	32	32	170	32.4	25					
ADKT-I-R/L-2020-5-T20	●	●	20	20	125	20.5	20	DGN / GRP - 5				
ADKT-I-R/L-2525-5-T25	●	●	25	25	150	25.5	25					
ADKT-IG-R/L-1616-3-T18	●	○	16	16	125	16.3	18	GRP - 3				
ADKT-IG-R/L-2020-3-R20	●	●	20	20	125	20.4	20					
ADKT-IG-R/L-2525-3-T22	●	●	25	25	150	25.4	22					
ADKT-IGI-R/L-2020-2-T15	●	●	20	20	125	20.3	15	GIM / GIP - 2	AKV-02-M6x22	ABPL-01	AAL-03-3	
ADKT-IGI-R/L-2525-2-T15	●	●	25	25	150	25.4	15					
ADKT-IGI-R/L-1616-3-T15	●	●	16	16	125	16.4	15	GIM / GIP - 3				
ADKT-IGI-R/L-2020-3-T20	●	●	20	20	125	20.4	20					
ADKT-IGI-R/L-2525-3-T22	●	●	25	25	150	25.4	22					
ADKT-IGI-R/L-2525-4-T22	●	●	25	25	150	25.5	22	GIM / GIP - 4	2004-M8x1x20	-	AAL-05-4	
ADKT-IGI-R/L-2525-5-T25	●	●	25	25	150	25.6	25					
ADKT-IGI-R/L-2525-8-T30	●	○	25	25	150	25.8	30	GIM / GIP - 8				
ADKT-IGTN-R/L-2525-5-T25	●	●	25	25	150	25.6	25	GTN - 5				
ADKT-IDC-R/L-2525-3-T21	●	○	25	25	150	25.4	21	DCE - 3				

R: Sağ / Right / Rechts L: Sol/Left/Links

● Stokta / In Stock / Auf Lager ○ Stokta Yok / Non Stock Item / Kein Lagerartikel, Lieferzeit auf Anfrage
ISCR Ucuna Uygunudur. / Compatible with ISCR Insert. / Kompatibel mit ISCR Wendeplatten.

Sipariş Örneği/Ordering Example/Bestellbeispiel
1 ad./pcs./stück ADKT-I-R-1212-2-T15

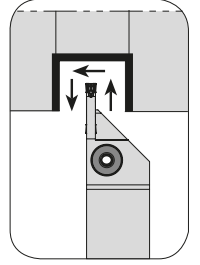
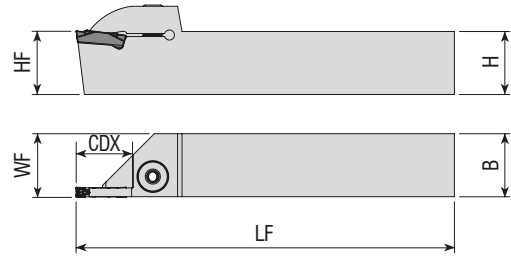

Takım Kodu Ordering Code Bestell-Bezeichnung	Stok Stock Lager		Takım Ölçüleri (mm) Dimension (mm) Abmessung (mm)					Kesici Uç Insert Wendeschneidplatte	Yedek Parçaları / Spare Parts / Ersatzteile		
	R	L	HF=H	B	LF	WF	CDX		Sıkma Vidası Screw Schraube	Pul Stamp Ring	Anahtar Allen Key Innensechskantschlüssel
ADKT-KM-R/L-2020-2-T15	●	●	20	20	125	20.3	15	A4. - 2	AKV-02-M6x22	ABPL-01	AAL-03-3
ADKT-KM-R/L-2525-2-T15	●	●	25	25	150	25.3	15				
ADKT-KM-R/L-2020-3-T20	●	●	20	20	125	20.4	20	A4. - 3	2004-M8x1x20	-	AAL-05-4
ADKT-KM-R/L-2525-3-T22	●	●	25	25	150	25.4	22				
ADKT-KM-R/L-2525-4-T22	●	●	25	25	150	25.5	22	A4. - 4			

KNMNTL Ucuna Uygunur. / Compatible with KNMNTL Insert. / Kompatibel mit KNMNTL Wendepplatten.

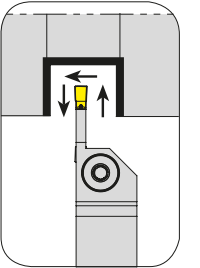
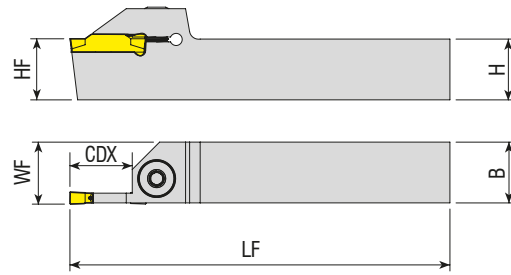

Takım Kodu Ordering Code Bestell-Bezeichnung	Stok Stock Lager		Takım Ölçüleri (mm) Dimension (mm) Abmessung (mm)					Kesici Uç Insert Wendeschneidplatte	Yedek Parçaları / Spare Parts / Ersatzteile		
	R	L	HF=H	B	LF	WF	CDX		Sıkma Vidası Screw Schraube	Pul Stamp Ring	Anahtar Allen Key Innensechskantschlüssel
ADKT-123-R/L-1212-1.5-R15	●	●	12	12	100	16.2	15	123 - 1.5	AKV-02-M6x22	ABPL-01	AAL-03-3
ADKT-123-R/L-1616-1.5-R15	●	●	16	16	125	16.3	15				
ADKT-123-R/L-1616-2-T15	●	●	16	16	125	16.3	15	123 - 2	AKV-02-M6x22	ABPL-01	AAL-03-3
ADKT-123-R/L-2020-2-T8	●	○	20	20	125	20.2	8				
ADKT-123-R/L-2020-2-T15	●	●	20	20	125	20.3	15	123 - 3	2004-M8x1x20	-	AAL-05-4
ADKT-123-R/L-2525-2-T15	●	●	25	25	150	25.3	15				
ADKT-123-R/L-2525-3-T15	●	●	25	25	150	25.4	22	123 - 4	2004-M8x1x20	-	AAL-05-4
ADKT-123-R/L-3232-2-T15	●	●	32	32	170	32.3	15				
ADKT-123-R/L-1616-3-T15	●	●	16	16	125	16.4	15	123 - 5	2004-M8x1x20	-	AAL-05-4
ADKT-123-R/L-2020-3-T20	●	●	20	20	125	20.4	20				
ADKT-123-R/L-2020-4-T20	●	●	20	20	125	20.4	20	123 - 6	2004-M8x1x20	-	AAL-05-4
ADKT-123-R/L-2525-4-T22	●	●	25	25	150	25.4	22				
ADKT-123-R/L-3232-4-T25	●	●	32	32	170	32.4	25	123 - 5	2004-M8x1x20	-	AAL-05-4
ADKT-123-R/L-2020-5-T20	●	●	20	20	125	20.5	20				
ADKT-123-R/L-2525-5-T25	●	●	25	25	150	25.5	25	123 - 6	2004-M8x1x20	-	AAL-05-4
ADKT-123-R/L-3232-6-T15	●	○	32	32	170	32.5	15				

R: Sağ / Right / Rechts L: Sol/Left/Links

● Stokta / In Stock / Auf Lager ○ Stokta Yok / Non Stock Item / Kein Lagerartikel, Lieferzeit auf Anfrage

SNDVK Ucuna Uygunur. / Compatible with SNDVK Insert. / Kompatibel mit SNDVK Wendepplatten.

Sipariş Örneği/Ordering Example/Bestellbeispiel

1 ad./pcs./stück ADKT-KM-R-2020-2-T15

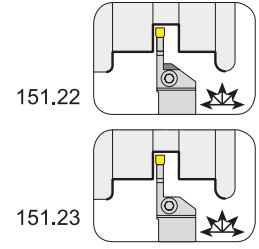
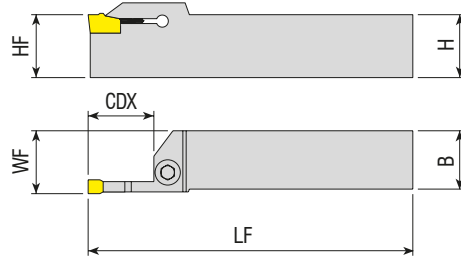

Takım Kodu Ordering Code Bestell-Bezeichnung	Stok Stock Lager		Takım Ölçüleri (mm) Dimension (mm) Abmessung (mm)					Kesici Uç Insert Wendeschneidplatte	Yedek Parçaları / Spare Parts / Ersatzteile			
	R	L	HF=H	B	LF	WF	CDX		Sıkma Vidası Screw Schraube	Pul Stamp Ring	Anahtar Allen Key Inmenschlüssel	
ADKT-151.22-R/L-1616-2-T15	●	●	16	16	125	16.3	15	151.2 - 2	AKV-02-M6x22	ABPL-01	AAL-03-3	
ADKT-151.22-R/L-2020-2-T15	●	●	20	20	125	20.3	15					
ADKT-151.22-R/L-2525-2-T15	●	●	25	25	150	25.3	15					
ADKT-151.22-R/L-1616-3-T15	●	●	16	16	125	16.4	15	151.2 - 3	2004-M8x1x20	-	AAL-05-4	
ADKT-151.22-R/L-2020-3-T20	●	●	20	20	125	20.4	20					
ADKT-151.22-R/L-2525-3-T22	●	●	25	25	150	25.4	22					
ADKT-151.22-R/L-1616-4-T15	●	●	16	16	125	16.4	15	151.2 - 4	2004-M8x1x20	-	AAL-05-4	
ADKT-151.22-R/L-2020-4-T20	●	●	20	20	125	20.4	20					
ADKT-151.22-R/L-2525-4-T22	●	●	25	25	150	25.4	22					
ADKT-151.22-R/L-2020-5-T20	●	●	20	20	125	20.5	20	151.2 - 5	2004-M8x1x20	-	AAL-05-4	
ADKT-151.22-R/L-2525-5-T25	●	●	25	25	150	25.5	25					
ADKT-151.23-R/L-1616-2-T15	●	●	16	16	125	16.3	15	151.2 - 2	AKV-02-M6x22	ABPL-01	AAL-03-3	
ADKT-151.23-R/L-2020-2-T15	●	●	20	20	125	20.3	15					
ADKT-151.23-R/L-2525-2-T15	●	●	25	25	150	25.3	15					
ADKT-151.23-R/L-1616-2.5-T15	●	●	16	16	125	16.3	15	151.2 - 2.5	2004-M8x1x20	-	AAL-05-4	
ADKT-151.23-R/L-2020-2.5-T15	●	●	20	20	125	20.3	15					
ADKT-151.23-R/L-2525-2.5-T15	●	●	25	25	150	25.3	15					
ADKT-151.23-R/L-1212-3-T15	●	●	12	12	100	16.4	15	151.2 - 3	2004-M8x1x20	-	AAL-05-4	
ADKT-151.23-R/L-1616-3-T15	●	●	16	16	125	16.4	15					
ADKT-151.23-R/L-2020-3-T20	●	●	20	20	125	20.4	20					
ADKT-151.23-R/L-2525-3-T20	●	●	25	25	150	25.4	20	151.2 - 4	2004-M8x1x20	-	AAL-05-4	
ADKT-151.23-R/L-2525-3-T22	●	●	25	25	150	25.4	22					
ADKT-151.23-R/L-1616-4-T15	●	●	16	16	125	16.4	15					
ADKT-151.23-R/L-2020-4-T20	●	●	20	20	125	20.4	20	151.2 - 5	2004-M8x1x20	-	AAL-05-4	
ADKT-151.23-R/L-2525-4-T22	●	●	25	25	150	25.4	22					
ADKT-151.23-R/L-2020-5-T20	●	●	20	20	125	20.5	20	151.2 - 5	2004-M8x1x20	-	AAL-05-4	
ADKT-151.23-R/L-2525-5-T25	●	●	25	25	150	25.5	25					

R: Sağ / Right / Rechts L: Sol/Left/Links

● Stokta / In Stock / Auf Lager ○ Stokta Yok / Non Stock Item / Kein Lagerartikel, Lieferzeit auf Anfrage
SNDVK Ucuna Uygundur. / Compatiple with SNDVK Insert. / Kompatibel mit SNDVK Wendeplatten.

Sipariş Örneği/Ordering Example/Bestellbeispiel
1 ad./pcs./stück ADKT-151.22-R-1616-2-T15

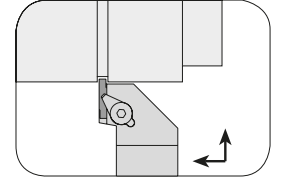
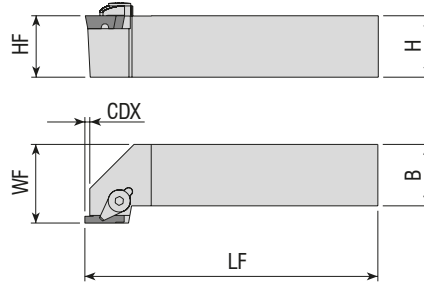

Takım Kodu Ordering Code Bestell-Bezeichnung	Stok Stock Lager		Takım Ölçüleri (mm) Dimension (mm) Abmessung (mm)					Kesici Uç Insert Wendeschneidplatte	Yedek Parçaları / Spare Parts / Ersatzteile				
	R	L	HF=H	B	LF	WF	CDX		Baskı Parçası Wedge Clamp Spannspratze	Sıkma Vidası Screw Schraube	Pul Stamp Ring	Anahtar Allen Key Innensechskantschlüssel	
ADKT-154.91-R/L-2020-3-T4	●	●	20	20	125	25	4	154.91 - 3	ACK-03	AKV-07-M6x22	APM-06	AAL-03-3	
ADKT-154.91-R/L 2525-3-T4	●	●	25	25	150	30.5	4						
ADKT-154.91-R/L 2020-5-T5	●	●	20	20	125	25	5	154.91 - 5	ACK-03	AKV-07-M6x22	APM-06	AAL-03-3	
ADKT-154.91-R/L 2525-5-T5	●	●	25	25	150	30.5	5						

SNDVK Ucuna Uygun. / Compatible with SNDVK Insert. / Kompatibel mit SNDVK Wendeplatten.

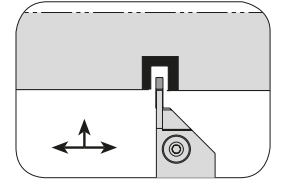
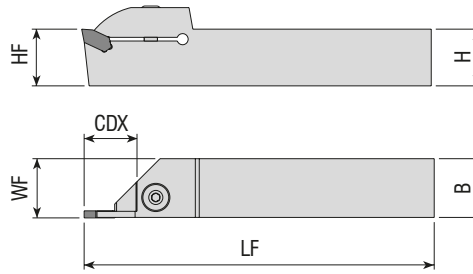

Takım Kodu Ordering Code Bestell-Bezeichnung	Stok Stock Lager		Takım Ölçüleri (mm) Dimension (mm) Abmessung (mm)					Kesici Uç Insert Wendeschneidplatte	Yedek Parçaları / Spare Parts / Ersatzteile			
	R	L	HF=H	B	LF	WF	CDX		Sıkma Vidası Screw Schraube	Pul Stamp Ring	Anahtar Allen Key Innensechskantschlüssel	
ADKT-ARN-R/L-2020-2-T15	●	●	20	20	125	20.3	15	LOMR. - 2	AKV-02-M6x22	ABPL-01	AAL-03-3	
ADKT-ARN-R/L-2525-2-T15	●	●	25	25	150	25.3	15					
ADKT-ARN-R/L-2020-3-T20	●	●	20	20	125	20.4	20	LOMR. - 3	2004-M8x1x20	-	AAL-05-4	
ADKT-ARN-R/L-2525-3-T22	●	●	25	25	150	25.4	22					

R: Sağ / Right / Rechts L: Sol/Left/Links

● Stokta / In Stock / Auf Lager ○ Stokta Yok / Non Stock Item / Kein Lagerartikel, Lieferzeit auf Anfrage

ARN Ucuna Uygun. / Compatible with ARN Insert. / Kompatibel mit ARN Wendeplatten.

Sipariş Örneği/Ordering Example/Bestellbeispiel

1 ad./pcs./stück ADKT-154.91-R-2020-3-T4

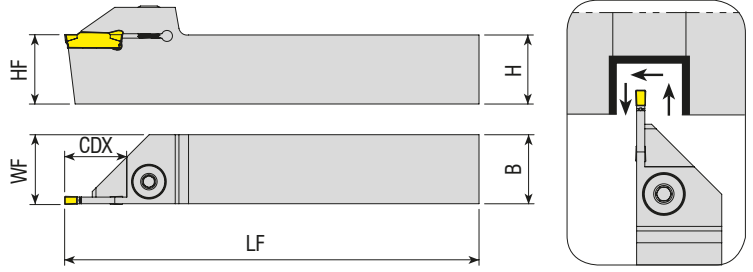

Takım Kodu Ordering Code Bestell-Bezeichnung	Stok Stock Lager		Takım Ölçüleri (mm) Dimension (mm) Abmessung (mm)				Kesici Uç Insert Wendeschneidplatte	Yedek Parçaları / Spare Parts / Ersatzteile			
	R	L	HF=H	B	LF	WF		CDX	Sıkma Vidası Screw Schraube	Pul Stamp Ring	Anahtar Allen Key Innensechskantschlüssel
ADKT-TD-R/L-1212-2-T15	●	●	12	12	100	12.3	15	TD. - 2	AKV-02-M6x22	ABPL-01	AAL-03-3
ADKT-TD-R/L-1616-2-T15	●	●	16	16	125	16.3	15				
ADKT-TD-R/L-2020-2-T9	●	○	20	20	125	20.3	9				
ADKT-TD-R/L-2020-2-T15	●	●	20	20	125	20.3	15				
ADKT-TD-R/L-2020-2-T20	●	○	20	20	125	20.3	20				
ADKT-TD-R/L-2525-2-T17	●	●	25	25	150	25.3	17	TD. - 3	2004-M8x1x20	-	AAL-05-4
ADKT-TD-R/L-1212-3-T15	●	●	12	12	100	12.4	15				
ADKT-TD-R/L-1616-3-T15	●	●	16	16	125	16.4	15				
ADKT-TD-R/L-2020-3-T20	●	●	20	20	125	20.4	20				
ADKT-TD-R/L-2020-3-T25	●	○	20	20	125	20.4	25				
ADKT-TD-R/L-2020-3-T30	●	●	20	20	125	20.4	30				
ADKT-TD-R/L-2525-3-T9	●	●	25	25	150	25.4	9				
ADKT-TD-R/L-2525-3-T22	●	●	25	25	150	25.4	22				
ADKT-TD-R/L-2525-3-T25	●	●	25	25	150	25.4	25				
ADKT-TD-R/L-2525-3-T30	●	○	25	25	150	25.4	30				
ADKT-TD-R/L-3232-3-T25	●	○	32	32	170	32.4	25	TD. - 4			
ADKT-TD-R/L-2525-4-T22	●	●	25	25	150	25.5	22				
ADKT-TD-R/L-2525-4-T30	●	○	25	25	150	25.5	30				
ADKT-TD-R/L-2525-5-T25	●	●	25	25	150	25.5	25	TD. - 5			

TGTC Ucuna Uygundur. / Compatible with TGTC Insert. / Kompatibel mit TGTC Wendepplatten.

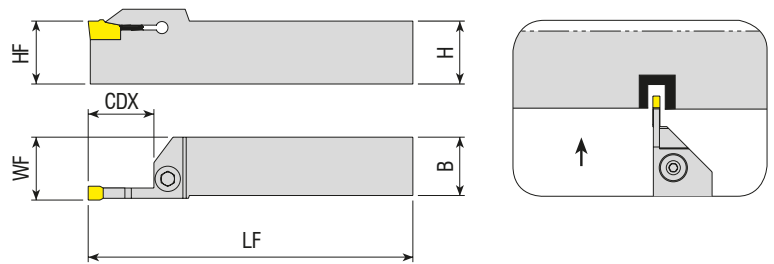

Takım Kodu Ordering Code Bestell-Bezeichnung	Stok Stock Lager		Takım Ölçüleri (mm) Dimension (mm) Abmessung (mm)				Kesici Uç Insert Wendeschneidplatte	Yedek Parçaları / Spare Parts / Ersatzteile			
	R	L	HF=H	B	LF	WF		CDX	Sıkma Vidası Screw Schraube	Pul Stamp Ring	Anahtar Allen Key Innensechskantschlüssel
ADKT-SWC-R/L-2020-2-T25	●	○	20	20	125	20.3	25	WCF - 2	AKV-02-M6x22	ABPL-01	AAL-03-3
ADKT-SWC-R/L-2020-3-T25	●	○	20	20	125	20.4	25	WCF - 3	2004-M8x1x20	-	AAL-05-4

R: Sağ / Right / Rechts L: Sol/Left/Links

● Stokta / In Stock / Auf Lager ○ Stokta Yok / Non Stock Item / Kein Lagerartikel, Lieferzeit auf Anfrage
SMTM Ucuna Uygundur. / Compatible with SMTM Insert. / Kompatibel mit SMTM Wendepplatten.

Sipariş Örneği/Ordering Example/Bestellbeispiel
1 ad./pcs./stück ADKT-TD-R-1212-2-T15

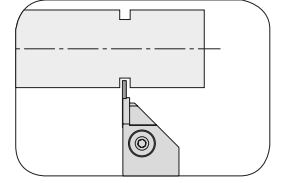
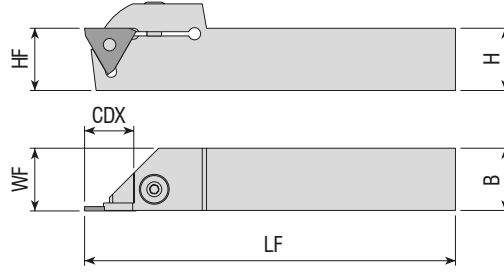

Takım Kodu Ordering Code Bestell-Bezeichnung	Stok Stock Lager		Takım Ölçüleri (mm) Dimension (mm) Abmessung (mm)					Kesici Uç Insert Wendeschneidplatte	Yedek Parçaları / Spare Parts / Ersatzteile				
	R	L	HF=H	B	LF	WF	CDX		Sıkma Vidası Screw Schraube	Baskı Pabucu Wedge Clamp Spannpratze	Sekman Ring Feder	Anahtar Allen Key Innensechskantschlüssel	
ADKT-H22-R/L-1616-(0.5-2)-T4	●	●	16	16	125	16.2	4	S312 - (0.5-2)	AKV-29-M6x29	AKK-04	AS-01	AAL-03-3	
ADKT-H22-R/L-2020-(0.5-2)-T4	●	●	20	20	125	20.2	4						
ADKT-H22-R/L-2525-(0.5-2)-T4	●	●	25	25	150	25.2	4						

HRN Ucuna Uygunudur. / Compatible with HRN Insert. / Kompatibel mit HRN Wendeplatten.

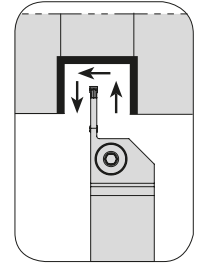
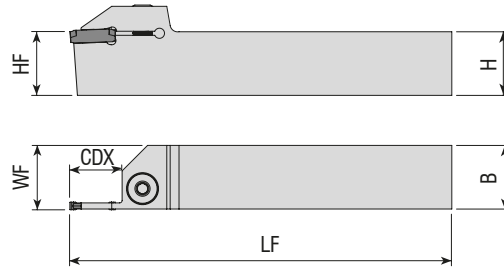

Takım Kodu Ordering Code Bestell-Bezeichnung	Stok Stock Lager		Takım Ölçüleri (mm) Dimension (mm) Abmessung (mm)					Kesici Uç Insert Wendeschneidplatte	Yedek Parçaları / Spare Parts / Ersatzteile			
	R	L	HF=H	B	LF	WF	CDX		Sıkma Vidası Screw Schraube	Pul Stamp Ring	Anahtar Allen Key Innensechskantschlüssel	
ADKT-LGC-R/L-1616-2-D40	●	●	16	16	125	16.2	20	GCTX - 2	AKV-02-M6x22	ABPL-01	-	AAL-03-3
ADKT-LGC-R/L-2020-2-D40	●	●	20	20	125	20.2	20					
ADKT-LGC-R/L-2525-2-D40	●	●	25	25	150	25.2	20					
ADKT-LGC-R/L-1616-3-T20	●	●	16	16	125	16.3	20	GCTX - 3	2004-M8x1x20	-	-	AAL-05-4
ADKT-LGC-R/L-2020-3-T20	●	●	20	20	125	20.3	20					
ADKT-LGC-R/L-2525-3-T20	●	●	25	25	150	25.3	20					

R: Sağ / Right / Rechts L: Sol/Left/Links

● Stokta / In Stock / Auf Lager ○ Stokta Yok / Non Stock Item / Kein Lagerartikel, Lieferzeit auf Anfrage

LMN Ucuna Uygunudur. / Compatible with LMN Insert. / Kompatibel mit LMN Wendeplatten.

Sipariş Örneği/Ordering Example/Bestellbeispiel

1 ad./pcs./stück ADKT-H22-R-1616-(0.5-2)T16

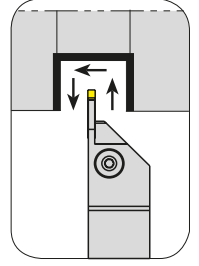
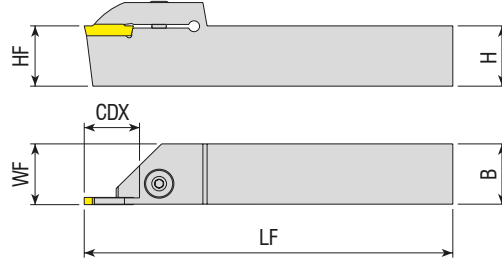

Takım Kodu Ordering Code Bestell-Bezeichnung	Stok Stock Lager		Takım Ölçüleri (mm) Dimension (mm) Abmessung (mm)					Kesici Uç Insert Wendeschneidplatte	Yedek Parçaları / Spare Parts / Ersatzteile			
	R	L	HF=H	B	LF	WF	CDX		Sıkma Vidası Screw Schraube	Pul Stamp Ring	Anahtar Allen Key Innerschraubenschlüssel	
ADKT-WGX16-R/L-2020-2-R16	●	○	20	20	125	20.3	16	GX16. - 2	AKV-02-M6x22	ABPL-01	AAL-03-3	
ADKT-WGX16-R/L-2525-2-R16	●	○	25	25	150	20.3	16					
ADKT-WGX24-R/L-2020-3-T20	●	●	20	20	125	20.3	20	GX24. - 3	2004-M8x1x20	-	AAL-05-4	
ADKT-WGX24-R/L-2525-3-T22	●	●	25	25	150	25.3	22					
ADKT-WGX24-R/L-3232-3-T22	●	○	32	32	170	32.3	22	GX24. - 4	-	-	-	
ADKT-WGX24-R/L-2525-4-T22	●	●	25	25	150	25.4	22					
ADKT-WGX24-R/L-2525-5-T25	●	●	25	25	150	25.5	25	GX24. - 5	-	-	-	
ADKT-WGX24-R/L-3232-5-T25	●	●	32	32	170	32.5	25					

WLTR Ucuna Uygun. / Compatible with WLTR Insert. / Kompatibel mit WLTR Wendeplatten.

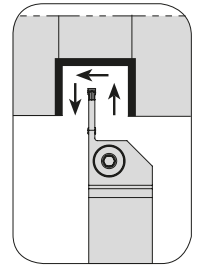
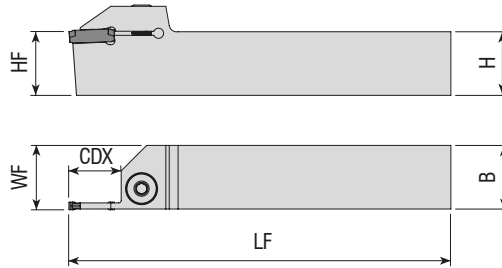

Takım Kodu Ordering Code Bestell-Bezeichnung	Stok Stock Lager		Takım Ölçüleri (mm) Dimension (mm) Abmessung (mm)					Kesici Uç Insert Wendeschneidplatte	Yedek Parçaları / Spare Parts / Ersatzteile			
	R	L	HF=H	B	LF	WF	CDX		Sıkma Vidası Screw Schraube	Pul Stamp Ring	Anahtar Allen Key Innerschraubenschlüssel	
ADKT-GP-R/L-2020-2-T15	●	●	20	20	125	20.2	15	GP - 2	AKV-02-M6x22	ABPL-01	AAL-03-3	
ADKT-GP-R/L-2525-2-T15	●	●	25	25	150	25.2	15					
ADKT-GP-R/L-2020-3-T20	●	●	20	20	125	20.3	20	GP - 3	2004-M8x1x20	-	AAL-05-4	
ADKT-GP-R/L-2525-3-T22	●	●	25	25	150	25.3	22					
ADKT-GP-R/L-2525-4-T22	●	●	25	25	150	25.4	22	GP - 4	-	-	-	
ADKT-GP-R/L-2525-5-T25	●	●	25	25	150	25.5	25					

R: Sağ / Right / Rechts L: Sol/Left/Links
● Stokta / In Stock / Auf Lager ○ Stokta Yok / Non Stock Item / Kein Lagerartikel, Lieferzeit auf Anfrage
PLBT Ucuna Uygun. / Compatible with PLBT Insert. / Kompatibel mit PLBT Wendeplatten.

Sipariş Örneği/Ordering Example/Bestellbeispiel
1 ad./pcs./stück ADKT-WGX24-R-2525-3-T22

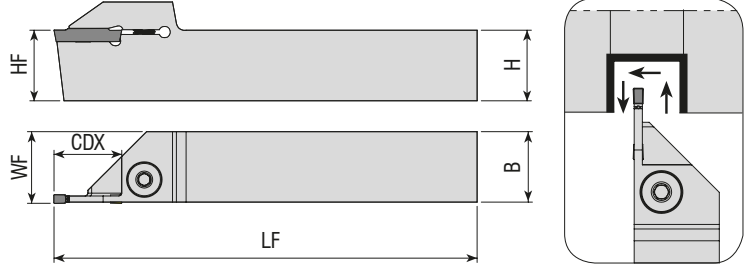

Takım Kodu Ordering Code Bestell-Bezeichnung	Stok Stock Lager		Takım Ölçüleri (mm) Dimension (mm) Abmessung (mm)					Kesici Uç Insert Wendeschneidplatte	Yedek Parçaları / Spare Parts / Ersatzteile		
	R	L	HF=H	B	LF	WF	CDX		Sıkma Vidası Screw Schraube	Pul Stamp Ring	Anahtar Allen Key Innerschlüssel
ADKT-CD-R/L-2020-3-R20	●	○	20	20	125	20.3	20	GX24 0300	2004-M8x1x20	-	AAL-05-4
ADKT-CD-R/L-2525-3-R23	●	○	25	25	150	25.3	23				

CRTZT Ucuna Uygunur. / Compatible with CRTZT Insert. / Kompatibel mit CRTZT Wendeplatten.

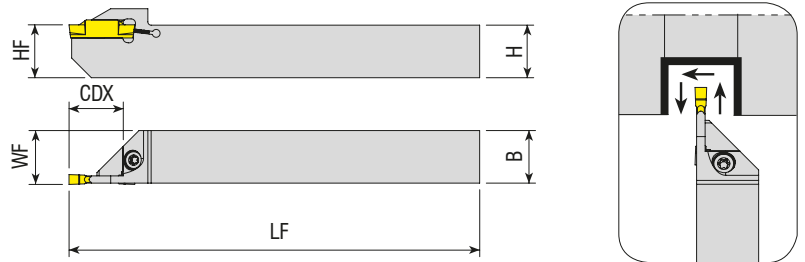

Takım Kodu Ordering Code Bestell-Bezeichnung	Stok Stock Lager		Takım Ölçüleri (mm) Dimension (mm) Abmessung (mm)					Kesici Uç Insert Wendeschneidplatte	Yedek Parçaları / Spare Parts / Ersatzteile		
	R	L	HF=H	B	LF	WF	CDX		Sıkma Vidası Screw Schraube	Pul Stamp Ring	Anahtar Allen Key Innerschlüssel
ADKT-TD-R/L-1212-2-T12-K-S	●	●	12	12	125	12.2	12	TD. - 2	4015-M4x11	-	80-T15
ADKT-TD-R/L-1616-2-T16-K-S	●	●	16	16	125	16.2	16				
ADKT-TD-R/L-1212-3-T12-K-S	●	●	12	12	125	12.3	12	TD. - 3	4015-M4x11	-	80-T15
ADKT-TD-R/L-1616-3-T16-K-S	●	●	16	16	125	16.3	16				

R: Sağ / Right / Rechts L: Sol/Left/Links
● Stokta / In Stock / Auf Lager ○ Stokta Yok / Non Stock Item / Kein Lagerartikel, Lieferzeit auf Anfrage
TGTC Ucuna Uygunur. / Compatible with TGTC Insert. / Kompatibel mit TGTC Wendeplatten.

Sipariş Örneği/Ordering Example/Bestellbeispiel
1 ad./pcs./stück ADKT-CD-R-2020-3-R20

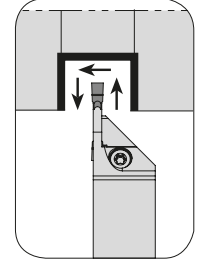
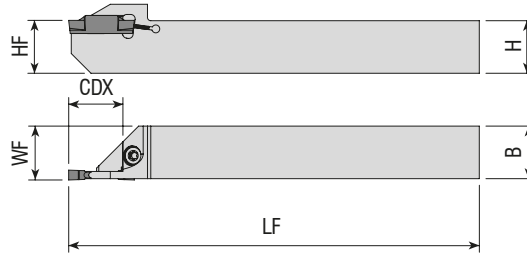

Takım Kodu Ordering Code Bestell-Bezeichnung	Stok Stock Lager		Takım Ölçüleri (mm) Dimension (mm) Abmessung (mm)				Kesici Uç Insert Wendeschneidplatte	Yedek Parçaları / Spare Parts / Ersatzteile			
	R	L	HF=H	B	LF	WF		CDX	Sıkma Vidası Screw Schraube	Pul Stamp Ring	Anahtar Allen Key Innerschlüsselschlüssel
ADKT-ZCC2-R/L-1010-2-T12-K-S	●	●	10	10	125	10.2	12	Z.BD - 2	4015-M4x11	-	80-T15
ADKT-ZCC2-R/L-1212-2-T12-K-S	●	●	12	12	125	12.2	12				
ADKT-ZCC2-R/L-1616-2-R16-K-S	●	●	16	16	125	16.2	16	Z.FD - 3			
ADKT-ZCC2-R/L-1212-3-T12-K-S	●	●	12	12	125	12.3	12				

ZCC Ucuna Uygundur. / Compatible with ZCC Insert. / Kompatibel mit ZCC Wendepfatten.

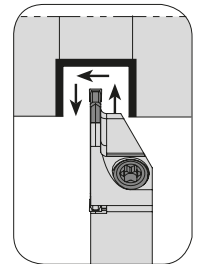
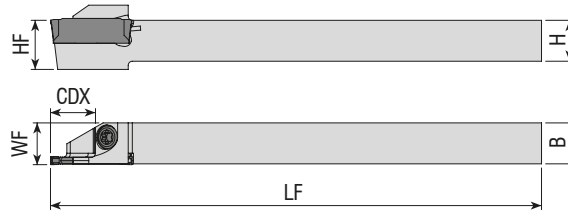
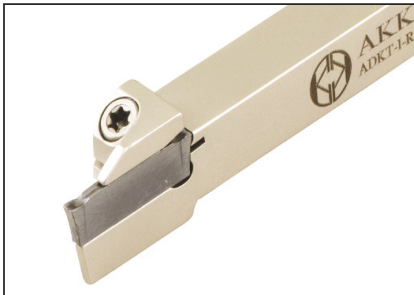

Takım Kodu Ordering Code Bestell-Bezeichnung	Stok Stock Lager		Takım Ölçüleri (mm) Dimension (mm) Abmessung (mm)				Kesici Uç Insert Wendeschneidplatte	Yedek Parçaları / Spare Parts / Ersatzteile			
	R	L	HF=H	B	LF	WF		CDX	Sıkma Vidası Screw Schraube	Pul Stamp Ring	Anahtar Allen Key Innerschlüsselschlüssel
ADKT-I-R/L-0808-2-R10-S	●	●	08	08	100	8.2	10	DGN - 2	4015-M4x11	-	80-T15
ADKT-I-R/L-1010-2-R10-K-S	●	●	10	10	120	10.2	10				
ADKT-I-R/L-1212-2-R12-K-S	●	●	12	12	125	12.2	12	DGN - 3			
ADKT-I-R/L-1616-3-R16-K-S	●	●	16	16	120	16.3	16				

R: Sağ / Right / Rechts L: Sol/Left/Links
● Stokta / In Stock / Auf Lager ○ Stokta Yok / Non Stock Item / Kein Lagerartikel, Lieferzeit auf Anfrage
ISCR Ucuna Uygundur. / Compatible with ISCR Insert. / Kompatibel mit ISCR Wendepfatten.

Sipariş Örneği/Ordering Example/Bestellbeispiel
1 ad./pcs./stück ADKT-ZCC2-R-1010-2-T12-K-S

DIŞ ÇAP KANAL AÇMA İSVİÇRE TİPİ KAYAR OTOMAT MAKİNA TAKIMLARI
EXTERNAL GROOVING TOOLHOLDERS FOR SWISS TYPE SLIDING AUTOMATIC LATHES
WERKZEUGE ZUR STECHBEARBEITUNG AUF LANGDREHAUTOMATEN

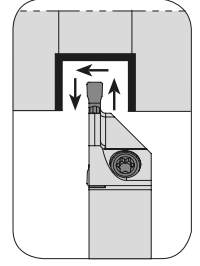
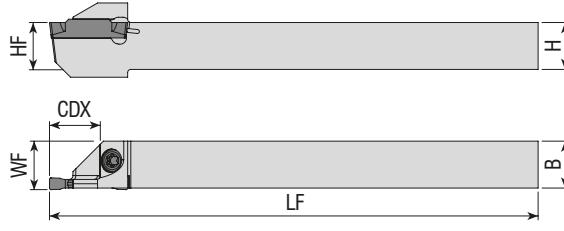

Takım Kodu Ordering Code Bestell-Bezeichnung	Stok Stock Lager		Takım Ölçüleri (mm) Dimension (mm) Abmessung (mm)					Kesici Uç Insert Wendeschneidplatte	Yedek Parçaları / Spare Parts / Ersatzteile		
	R	L	HF=H	B	LF	WF	CDX		Sıkma Vidası Screw Schraube	Pul Stamp Ring	Anahtar Allen Key Innerschlüsselschlüssel
ADKT-KG-R/L-1212-2-R12-K-S	●	●	12	12	125	12.2	12	KG. - 2	4015-M4x11	-	80-T15
ADKT-KG-R/L-1616-2-R16-K-S	●	●	16	16	125	16.2	16				
ADKT-KG-R/L-1212-3-R12-K-S	●	●	12	12	125	12.3	12	KG. - 3	4015-M4x11	-	80-T15
ADKT-KG-R/L-1616-3-R16-K-S	●	●	16	16	125	16.3	16				

KRLY Ucuna Uygundur. / Compatible with KRLY Insert. / Kompatibel mit KRLY Wendeplatten.

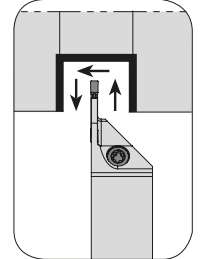
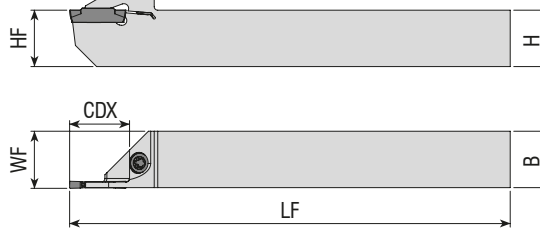

Takım Kodu Ordering Code Bestell-Bezeichnung	Stok Stock Lager		Takım Ölçüleri (mm) Dimension (mm) Abmessung (mm)					Kesici Uç Insert Wendeschneidplatte	Yedek Parçaları / Spare Parts / Ersatzteile		
	R	L	HF=H	B	LF	WF	CDX		Sıkma Vidası Screw Schraube	Pul Stamp Ring	Anahtar Allen Key Innerschlüsselschlüssel
ADKT-K-R/L-1212-2-R12-K-S	●	●	12	12	125	12.20	12	MGM. - 2	4015-M4x11	-	80-T15
ADKT-K-R/L-1616-2-R16-K-S	●	●	16	16	125	16.20	16				
ADKT-K-R/L-1212-3-R12-K-S	●	●	12	12	125	12.30	12	MGM. - 3	4015-M4x11	-	80-T15
ADKT-K-R/L-1616-3-R16-K-S	●	●	16	16	125	16.30	16				

R: Sağ / Right / Rechts L: Sol/Left/Links

● Stokta / In Stock / Auf Lager ○ Stokta Yok / Non Stock Item / Kein Lagerartikel, Lieferzeit auf Anfrage

KRLY Ucuna Uygundur. / Compatible with KRLY Insert. / Kompatibel mit KRLY Wendeplatten.

Sipariş Örneği/Ordering Example/Bestellbeispiel
1 ad./pcs./stück ADKT-KG-R-1212-2-R12-K-S

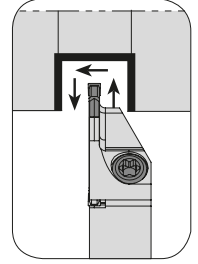
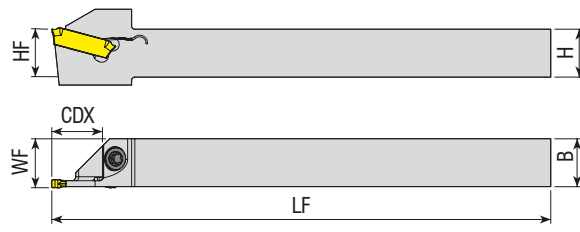

Takım Kodu Ordering Code Bestell-Bezeichnung	Stok Stock Lager		Takım Ölçüleri (mm) Dimension (mm) Abmessung (mm)					Kesici Uç Insert Wendeschneidplatte	Yedek Parçaları / Spare Parts / Ersatzteile			
	R	L	HF=H	B	LF	WF	CDX		Sıkma Vidası Screw Schraube	Pul Stamp Ring	Anahtar Allen Key Innensechskantschlüssel	
ADKT-WGX16-R/L-1212-2-R12-K-S	●	●	12	12	125	12.2	16	GX16 - 2	4015-M4x11	-	80-T15	
ADKT-WGX16-R/L-1616-2-R16-K-S	●	○	16	16	125	16.2	16					
ADKT-WGX24-R/L-1616-3-R16-K-S	●	○	16	16	125	16.3	16	GX24 - 3				

WLTR Ucuna Uygun. / Compatible with WLTR Insert. / Kompatibel mit WLTR Wendeplatten.

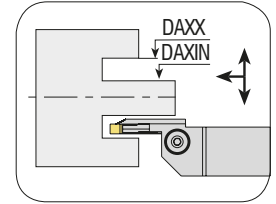
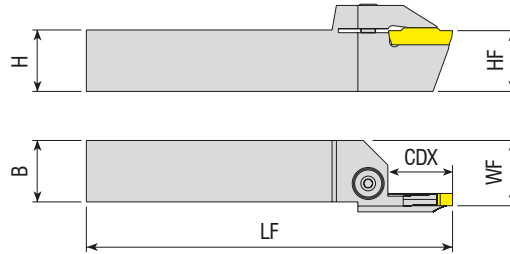

Takım Kodu Ordering Code Bestell-Bezeichnung	Stok Stock Lager		Takım Ölçüleri (mm) Dimension (mm) Abmessung (mm)							Kesici Uç Insert Wendeschneidplatte	Yedek Parçaları / Spare Parts / Ersatzteile			
	R	L	HF=H	B	LF	WF	CDX	DAXIN	DAXX		Sıkma Vidası Screw Schraube	Pul Stamp Ring	Anahtar Allen Key Innensechskantschlüssel	
AAKT-KG-R/L-2525-44-70-4-T22	○	○	25	25	150	26.5	22	44	70	KG.. - 4	2004-M8x1x20	-	AAL-05-4	
AAKT-KG-R/L-2525-60-120-4-T22	○	○	25	25	150	26.5	22	60	120					
AAKT-KG-R/L-2525-112-200-4-T22	○	○	25	25	150	26.5	22	112	200					

R: Sağ / Right / Rechts L: Sol/Left/Links
● Stokta / In Stock / Auf Lager ○ Stokta Yok / Non Stock Item / Kein Lagerartikel, Lieferzeit auf Anfrage
KRLY Ucuna Uygun. / Compatible with KRLY Insert. / Kompatibel mit KRLY Wendeplatten.

Sipariş Örneği/Ordering Example/Bestellbeispiel
1 ad./pcs./stück ADKT-WGX16-R-1212-2-R12-K-S

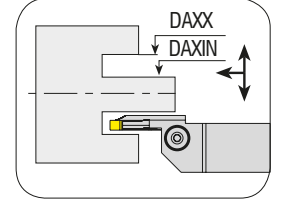
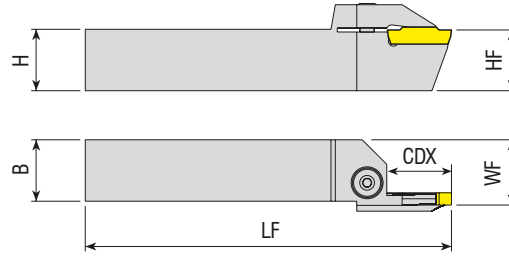

Takım Kodu Ordering Code Bestell-Bezeichnung	Stok Stock Lager		Takım Ölçüleri (mm) Dimension (mm) Abmessung (mm)							Kesici Uç Insert Wendeschneidplatte	Yedek Parçaları / Spare Parts / Ersatzteile		
	R	L	HF=H	B	LF	WF	CDX	DAXIN	DAXX		Sıkma Vidası Screw Schraube	Pul Stamp Ring	Anahtar Allen Key Innerschraubenschlüssel
AAKT-K-R/L-2525-34-45-3-T17	●	●	25	25	150	26.5	17	34	45	MGM. - 3			
AAKT-K-R/L-2525-39-55-3-T17	●	●	25	25	150	26.5	17	39	55				
AAKT-K-R/L-2525-49-80-3-T17	●	●	25	25	150	26.5	17	49	80				
AAKT-K-R/L-2525-70-110-3-T17	●	●	25	25	150	26.5	17	70	110				
AAKT-K-R/L-2525-100-150-3-T17	●	●	25	25	150	26.5	17	100	150				
AAKT-K-R/L-2525-80-180-3-T32	●	●	25	25	150	26.5	32	80	180				
AAKT-K-R/L-2525-175-215-3-T22	●	●	25	25	150	26.5	22	175	215				
AAKT-K-R/L-2525-700-800-3-T17	●	●	25	25	150	26.5	17	700	800	MGM. - 4	2004-M8x1x20	-	AAL-05-4
AAKT-K-R/L-2525-50-85-4-T22	●	●	25	25	150	26.5	22	50	85				
AAKT-K-R/L-2525-70-110-4-T22	●	●	25	25	150	26.5	22	70	110				
AAKT-K-R/L-2525-100-150-4-T22	●	●	25	25	150	26.5	22	100	150				
AAKT-K-R/L-2525-80-180-4-T32	●	●	25	25	150	26.5	32	80	180				
AAKT-K-R/L-2525-180-800-4-T32	●	●	25	25	150	26.5	32	180	800				
AAKT-K-R/L-2525-70-110-5-T25	●	●	25	25	150	26.5	25	70	110				
AAKT-K-R/L-2525-100-150-5-T25	●	●	25	25	150	26.5	25	100	150				
AAKT-K-R/L-2525-80-180-5-T32	●	●	25	25	150	26.5	32	80	180				
AAKT-K-R/L-2525-140-200-5-T25	●	●	25	25	150	26.5	25	140	200				
AAKT-K-R/L-2525-180-800-5-T32	●	●	25	25	150	26.5	32	180	800	MGM. - 6			
AAKT-K-R/L-2525-60-100-6-T25	●	●	25	25	150	26.5	25	60	100				
AAKT-K-R/L-2525-60-100-6-T35	●	○	25	25	150	26.5	35	60	100				
AAKT-K-R/L-2525-100-200-6-T25	●	○	25	25	150	26.5	25	100	200				
AAKT-K-R/L-2525-100-200-6-T35	●	○	25	25	150	26.5	35	100	200				
AAKT-K-R/L-2525-100-200-6-T45	●	○	25	25	150	26.5	45	100	200				
AAKT-K-R/L-2525-140-300-6-T35	●	●	25	25	150	26.5	35	140	300	MGM. - 8			
AAKT-K-R/L-2525-140-300-8-T35	●	○	25	25	150	26.5	35	140	300				
AAKT-K-R/L-3232-140-350-8-T35	●	○	32	32	150	33.5	35	140	350				

R: Sağ / Right / Rechts L: Sol/Left/Links
● Stokta / In Stock / Auf Lager ○ Stokta Yok / Non Stock Item / Kein Lagerartikel, Lieferzeit auf Anfrage
KRLY Ucuna Uygunudur. / Compatible with KRLY Insert. / Kompatibel mit KRLY Wendeplatten.

Sipariş Örneği/Ordering Example/Bestellbeispiel
1 ad./pcs./stück AAKT-K-R-2525-34-45-3-T17

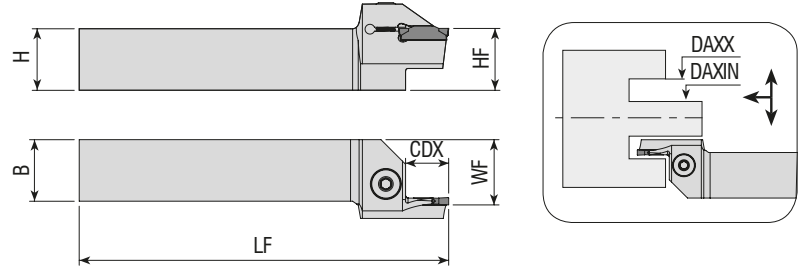

Takım Kodu Ordering Code Bestell-Bezeichnung	Takım Ölçüleri (mm) Dimension (mm) Abmessung (mm)									Kesici Uç Insert Wendeschneidplatte	Yedek Parçaları / Spare Parts / Ersatzteile		
	R	L	HF=H	B	LF	WF	CDX	DAXIN	DAXX		Sıkma Vidası Screw Schraube	Pul Stamp Ring	Anahtar Allen Key Insechschlüssel
AAKT-ZCC2-R/L-2525-140-180-2-T4	●	○	25	25	150	26.5	4	140	180	Z.BD - 2			
AAKT-ZCC2-R/L-2525-35-45-3-T17	●	●	25	25	150	26.5	17	35	45	Z.FD - 3			
AAKT-ZCC2-R/L-2525-39-55-3-T17	●	○	25	25	150	26.5	17	39	55				
AAKT-ZCC2-R/L-2525-49-80-3-T17	●	●	25	25	150	26.5	17	49	80				
AAKT-ZCC2-R/L-2525-70-110-3-T17	●	●	25	25	150	26.5	17	70	110				
AAKT-ZCC2-R/L-2525-100-150-3-T17	●	●	25	25	150	26.5	17	100	150				
AAKT-ZCC2-R/L-2525-40-60-4-T22	●	○	25	25	150	26.5	22	40	60	Z.GD - 4	2004-M8x1x20	-	AAL-05-4
AAKT-ZCC2-R/L-2525-52-80-4-T22	●	●	25	25	150	26.5	22	52	80				
AAKT-ZCC2-R/L-2525-72-110-4-T22	●	●	25	25	150	26.5	22	72	110				
AAKT-ZCC2-R/L-2525-100-150-4-T22	●	●	25	25	150	26.5	22	100	150				
AAKT-ZCC2-R/L-2525-140-200-4-T22	●	●	25	25	150	26.5	22	140	200				
AAKT-ZCC2-R/L-2525-55-95-5-T25	●	○	25	25	150	26.5	25	55	95	Z.HD - 5			
AAKT-ZCC2-R/L-2525-85-140-5-T25	●	●	25	25	150	26.5	25	85	140				
AAKT-ZCC2-R/L-2525-130-200-5-T25	●	○	25	25	150	26.5	25	130	200				
AAKT-ZCC2-R/L-2525-190-400-5-T25	●	●	25	25	150	26.5	25	190	400				
AAKT-ZCC2-R/L-2525-190-400-5-T35	●	○	25	25	150	26.5	35	190	400				
AAKT-ZCC2-R/L-2525-200-500-5-T17	●	●	25	25	150	26.5	25	200	500	Z.KD - 6			
AAKT-ZCC2-R/L-2525-60-110-6-T15	●	○	25	25	150	26.5	15	60	110				

R: Sağ / Right / Rechts L: Sol/Left/Links

● Stokta / In Stock / Auf Lager ○ Stokta Yok / Non Stock Item / Kein Lagerartikel, Lieferzeit auf Anfrage

ZCC Ucuna Uygundur. / Compatible with ZCC Insert. / Kompatibel mit ZCC Wendeplatten.

Sipariş Örneği/Ordering Example/Bestellbeispiel

1 ad./pcs./stück AAKT-ZCC2-R-2525-140-180-2-T4



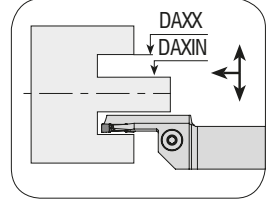
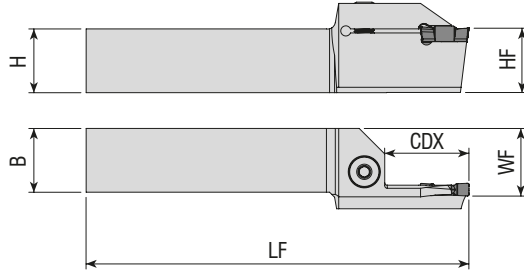

Takım Kodu Ordering Code Bestell-Bezeichnung	Stok Stock Lager		Takım Ölçüleri (mm) Dimension (mm) Abmessung (mm)							Kesici Uç Insert Wendeschneidplatte	Yedek Parçaları / Spare Parts / Ersatzteile		
	R	L	HF=H	B	LF	WF	CDX	DAXIN	DAXX	Sıkma Vidası Screw Schraube	Pul Stamp Ring	Anahtar Allen Key Innerschloßschlüssel	
AAKT-IG-R/L-2525-40-60-4-T25	●	●	25	25	150	26.5	25	40	60	DGN / GRP - 4	2004-M8x1x20	-	AAL-05-4
AAKT-IG-R/L-2525-52-80-4-T25	●	●	25	25	150	26.5	25	52	80				
AAKT-IG-R/L-2525-70-110-4-T28	●	●	25	25	150	26.5	28	70	110				
AAKT-IG-R/L-2525-72-110-4-T25	○	○	25	25	150	26.5	25	72	110				
AAKT-IG-R/L-2525-100-150-4-T25	●	○	25	25	150	26.5	25	100	150				
AAKT-IG-R/L-2525-110-200-4-T28	●	○	25	25	150	26.5	28	110	200				
AAKT-IG-R/L-2525-110-200-4-T32	●	●	25	25	150	26.5	32	110	200				
AAKT-IG-R/L-2525-140-200-4-T25	○	○	25	25	150	26.5	25	140	200				
AAKT-IG-R/L-2525-180-800-4-T28	●	●	25	25	150	26.5	28	180	800				
AAKT-IG-R/L-2525-200-800-4-T25	○	○	25	25	150	26.5	25	200	800				
AAKT-IG-R/L-2525-70-110-5-T32	●	●	25	25	150	26.5	32	70	110	DGN / GRP - 5			
AAKT-IG-R/L-2525-110-200-5-T9	●	○	25	25	150	26.5	9	110	200				
AAKT-IG-R/L-2525-110-200-5-T32	●	●	25	25	150	26.5	32	110	200				
AAKT-IG-R/L-2525-180-800-5-T32	●	●	25	25	150	26.5	32	180	800	DGN / GRP - 6			
AAKT-IG-R/L-2525-58-100-6-T32	●	○	25	25	150	26.5	32	58	100				
AAKT-IG-R/L-2525-88-180-6-T32	●	○	25	25	150	26.5	32	88	180				

R: Sağ / Right / Rechts L: Sol/Left/Links
● Stokta / In Stock / Auf Lager ○ Stokta Yok / Non Stock Item / Kein Lagerartikel, Lieferzeit auf Anfrage
ISCR Ucuna Uygunur. / Compatible with ISCR Insert. / Kompatibel mit ISCR Wendeschneidplatten.

Sipariş Örneği/Ordering Example/Bestellbeispiel
1 ad./pcs./stück AAKT-IG-R-2525-40-60-4-T25



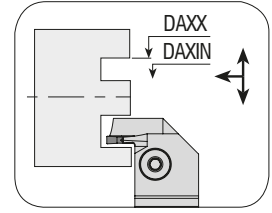
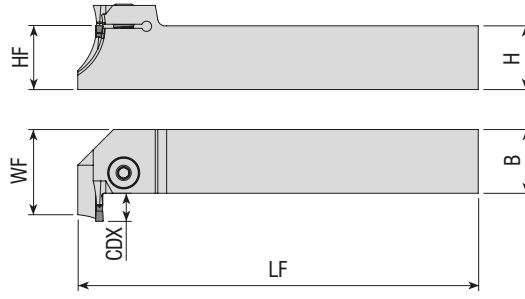

Takım Kodu Ordering Code Bestell-Bezeichnung	Stok Stock Lager		Takım Ölçüleri (mm) Dimension (mm) Abmessung (mm)							Kesici Uç Insert Wendeschneidplatte	Yedek Parçaları / Spare Parts / Ersatzteile		
	R	L	HF=H	B	LF	WF	CDX	DAXIN	DAXX	Sıkma Vidası Screw Schraube	Pul Stamp Ring	Anahtar Allen Key Innensechskantschlüssel	
ALKT-ZCC2-R/L-2525-35-45-3-T10	●	●	25	25	150	36	10	35	45	Z.FD - 3	2004-M8x1x20	-	AAL-05-4
ALKT-ZCC2-R/L-2525-39-55-3-T10	●	●	25	25	150	36	10	39	55				
ALKT-ZCC2-R/L-2525-35-∞-3-T4	●	●	25	25	150	30	4	35	∞				
ALKT-ZCC2-R/L-2525-40-60-4-T14	●	●	25	25	150	40	14	40	60	Z.GD - 4	-	AAL-05-4	
ALKT-ZCC2-R/L-2525-52-80-4-T14	●	○	25	25	150	40	14	52	80				
ALKT-ZCC2-R/L-2525-72-110-4-T14	●	○	25	25	150	40	14	72	110				
ALKT-ZCC2-R/L-2525-100-230-4-T14	●	○	25	25	150	40	14	100	230				
ALKT-ZCC2-R/L-2525-40-∞-4-T4	●	●	25	25	150	30	4	40	∞				

ZCC Ucuna Uygundur. / Compatible with ZCC Insert. / Kompatibel mit ZCC Wendepplatten.

KESME VE DERİN KANAL AÇMA LAMALARI
BLADES FOR PARTING AND DEEP GROOVING
STECHSCHWERT FÜR ABSTECHEN UND TIEFE EINSTICHE

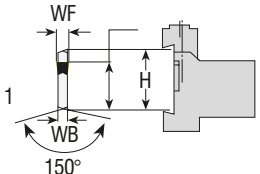
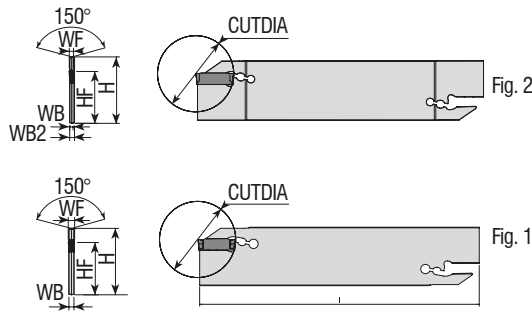
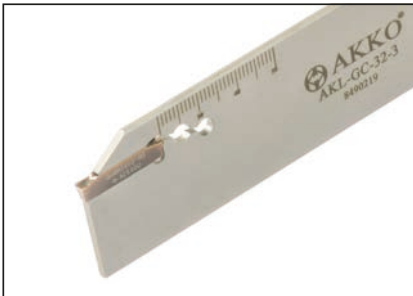

Takım Kodu Ordering Code Bestell-Bezeichnung	Stok Stock Lager	Takım Ölçüleri (mm) Dimension (mm) Abmessung (mm)								Kesici Uç Insert Wendeschneidplatte	Yedek Parçaları / Spare Parts / Ersatzteile	
		H	WF	WB2	WB	I	HF	CUTDIA	Fig.		Anahtar Allen Key Innensechskantschlüssel	
AKL-SGC-26-3	●	26	3	2.40	-	110	21.4	39	2	GCM N30	ALA-01	
AKL-SGC-32-3	●	32	3	2.40	-	150	25	39	1			

R: Sağ / Right / Rechts L: Sol/Left/Links
● Stokta / In Stock / Auf Lager ○ Stokta Yok / Non Stock Item / Kein Lagerartikel, Lieferzeit auf Anfrage
SMTM Ucuna Uygundur. / Compatible with SMTM Insert. / Kompatibel mit SMTM Wendepplatten.

Sipariş Örneği/Ordering Example/Bestellbeispiel
1 ad./pcs./stück ALKT-ZCC2-R-2525-35-45-3-T10

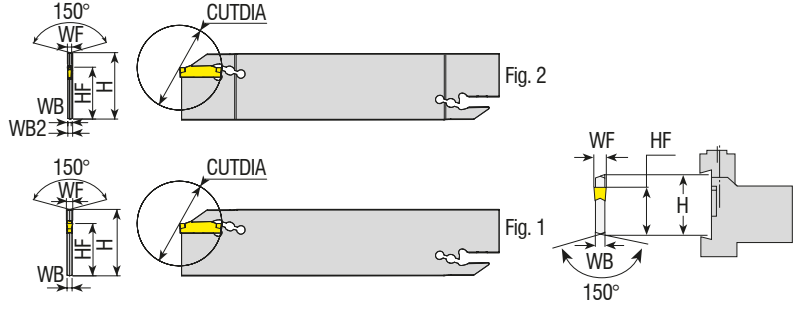

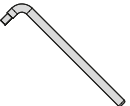
Takım Kodu Ordering Code Bestell-Bezeichnung	Stok Stock Lager	Takım Ölçüleri (mm) Dimension (mm) Abmessung (mm)								Kesici Uç Insert Wendeschneidplatte	Yedek Parçaları / Spare Parts Ersatzteile	
		H	WF	WB2	WB	I	HF	CUTDIA	Fig.		Anahtar Allen Key Innerschlüsselschlüssel	
AKL-TD-32-2	●	32	2	2.4	1.6	150	25	39	2			
AKL-TD-32-3	●	32	3	2.4	-	150	25	39	1	TD. - 2 TD. - 3		ALA-01

TGTC Ucuna Uygunur. / Compatible with TGTC Insert. / Kompatibel mit TGTC Wendepplatten.

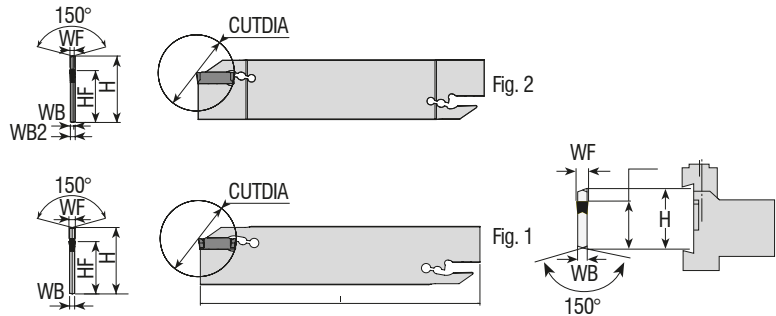

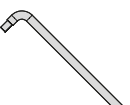

Takım Kodu Ordering Code Bestell-Bezeichnung	Stok Stock Lager	Takım Ölçüleri (mm) Dimension (mm) Abmessung (mm)								Kesici Uç Insert Wendeschneidplatte	Yedek Parçaları / Spare Parts Ersatzteile	
		H	WF	WB2	WB	I	HF	CUTDIA	Fig.		Anahtar Allen Key Innerschlüsselschlüssel	
AKL-I-26-2	●	26	1.9-2.5	1.6	-	110	21.4	39	1			
AKL-I-32-2	●	32	1.9-2.5	1.8	2.4	150	25	39	2			DGN - 2
AKL-I-26-3	●	26	3-3.18	2.4	-	110	21.4	39	1	DGN - 3	ALA-01	
AKL-I-32-3	●	32	3-3.18	2.4	-	150	25	39	1			
AKL-I-26-4	●	26	4	3.2	-	110	21.4	80	1	DGN / GRP - 4		
AKL-I-32-4	●	32	4	3.2	-	150	25	100	1			

R: Sağ / Right / Rechts L: Sol/Left/Links

● Stokta / In Stock / Auf Lager ○ Stokta Yok / Non Stock Item / Kein Lagerartikel, Lieferzeit auf Anfrage
 ISCR Ucuna Uygunur. / Compatible with ISCR Insert. / Kompatibel mit ISCR Wendepplatten.

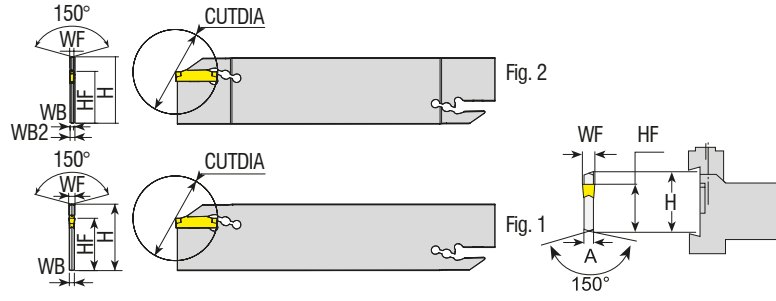

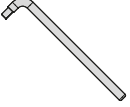

Sipariş Örneği/Ordering Example/Bestellbeispiel
 1 ad./pcs./stück AKL-TD-32-2

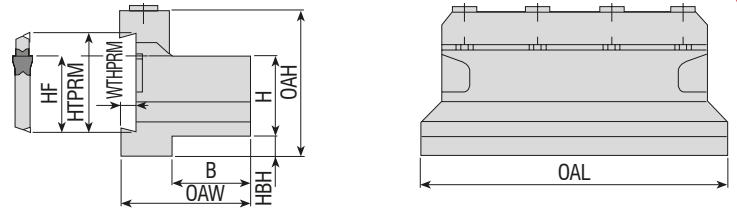

Takım Kodu Ordering Code Bestell-Bezeichnung	Stok Stock Lager	Takım Ölçüleri (mm) Dimension (mm) Abmessung (mm)								Kesici Uç Insert Wendeschneidplatte	Yedek Parçaları / Spare Parts Ersatzteile	
		H	WF	WB2	WB	I	HF	CUTDIA	Fig.		Anahtar Allen Key Innerschlüsselschlüssel	
AKL-123-32-2	●	32	2	2.4	1.6	150	25	39	2			
AKL-123-32-3	●	32	3	2.4	-	150	25	39	1	123 - 2		
AKL-123-32-4	●	32	4	3.2	-	150	25	39	1	123 - 3		
										123 - 4	ALA-01	

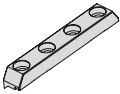
SNDVK Ucuna Uygunur. / Compatible with SNDVK Insert. / Kompatibel mit SNDVK Wendeplatten.

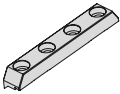

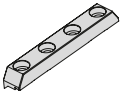
Takım Kodu Ordering Code Bestell-Bezeichnung	Stok Stock Lager	Takım Ölçüleri (mm) Dimension (mm) Abmessung (mm)									Yedek Parçaları / Spare Parts / Ersatzteile		
		HTPRM	HF	H	HBH	OAH	WTHPRM	OAL	B	OAW	Pabuç Clamp Spannspratze	Pabuç Vidası Clamp Screw Klemmschraube	Anahtar Allen Key Innerschlüsselschlüssel
ALBU-20-26	●	26	21.4	20	9	43	4	86	19	38		2505-M6x25	
ALBU-25-26	●	26	21.4	25	5	45	4	110	23	42			
ALBU-20-32	●	32	25	20	13	50	5.3	100	19	38		2505-M6x30	AAL-07-5
ALBU-25-32	●	32	25	25	8	50	5.3	110	23	42			
ALBU-32-32	●	32	25	32	5	54	5.3	110	29	48			

R: Sağ / Right / Rechts L: Sol/Left/Links
● Stokta / In Stock / Auf Lager ○ Stokta Yok / Non Stock Item / Kein Lagerartikel, Lieferzeit auf Anfrage

Sipariş Örneği/Ordering Example/Bestellbeispiel
1 ad./pcs./stück AKL-123-32-3

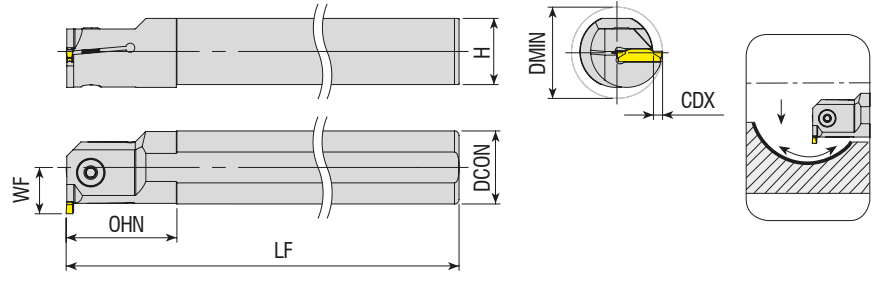

Takım Kodu Ordering Code Bestell-Bezeichnung	Stok Stock Lager		Takım Ölçüleri (mm) Dimension (mm) Abmessung (mm)							Kesici Uç Insert Wendeschneidplatte	Yedek Parçaları / Spare Parts / Ersatzteile	
	R	L	DCON	DMIN	LF	OHN	CDX	H	WF		Sıkma Vidası Screw Schraube	Anahtar Allen Key Innenbohrschlüssel
AIKT-K-R/L-16-2-T4	●	●	16	21	150	28	4	14.8	12	MGM. - 2	2503-M4x10	AAL-03-3
AIKT-K-R/L-20-2-T4	●	●	20	25	170	30	4	18.3	14		2503-M4x12	
AIKT-K-R/L-25-2-T6	●	●	25	32	200	40	6	23	18.5		2504-M5x12	
AIKT-K-R/L-20-3-T6	●	●	20	27	170	30	6	18.3	16	MGM. - 3	2504-M5x12	
AIKT-K-R/L-20-3-T7	●	●	20	25	170	38	7	18.3	13		2504-M5x12	
AIKT-K-R/L-25-3-T6	●	●	25	32	200	40	6	23	18.5		2504-M5x16	
AIKT-K-R/L-25-3-T10	●	●	25	32	200	48	10	23	17			
AIKT-K-R/L-32-3-T6	●	●	32	39	250	50	6	30	22			
AIKT-K-R/L-32-3-T12	●	●	32	39	250	53	12	30	22		2004-M8x1x20	
AIKT-K-R/L-40-3-T6	●	●	40	47	300	55	6	37.5	26			
AIKT-K-R/L-40-3-T12	●	○	40	48	300	63	12	37.5	27			
AIKT-K-R/L-20-4-T6	●	●	20	27	170	30	6	18.3	16	MGM. - 4	2504-M5x12	AAL-05-4
AIKT-K-R/L-20-4-T7	●	○	20	25	170	38	7	18.3	13		2504-M5x16	
AIKT-K-R/L-25-4-T6	●	●	25	32	200	40	6	23	18.5			
AIKT-K-R/L-25-4-T10	●	●	25	32	200	49	10	23	17			
AIKT-K-R/L-32-4-T6	●	●	32	39	250	50	6	30	22			
AIKT-K-R/L-32-4-T12	●	●	32	39	250	53	12	30	22		2004-M8x1x20	
AIKT-K-R/L-40-4-T6	●	●	40	47	300	55	6	37.5	26			
AIKT-K-R/L-40-4-T12	●	●	40	48	300	63	12	37.5	27			
AIKT-K-R/L-25-5-T7	●	●	25	33	200	40	7	23	19.5	MGM. - 5	2504-M5x16	
AIKT-K-R/L-32-5-T7	●	●	32	40	250	50	7	30	23		2004-M8x1x20	
AIKT-K-R/L-40-5-T7	●	●	40	48	300	55	7	37.5	27			
AIKT-K-R/L-40-5-T12	●	○	40	48	300	63	12	37.5	27			

R: Sağ / Right / Rechts L: Sol/Left/Links
● Stokta / In Stock / Auf Lager ○ Stokta Yok / Non Stock Item / Kein Lagerartikel, Lieferzeit auf Anfrage
KRLY Ucuna Uygunudur. / Compatible with KRLY Insert. / Kompatibel mit KRLY Wendeplatten.

Sipariş Örneği/Ordering Example/Bestellbeispiel
1 ad./pcs./stück AIKT-K-R-16-2-T4

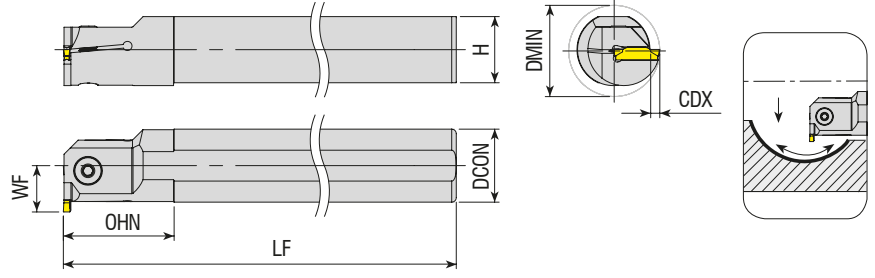

Takım Kodu
Ordering Code
Bestell-Bezeichnung

Stok
Stock
Lager

Takım Ölçüleri (mm)
Dimension (mm)
Abmessung (mm)

Kesici Uç
Insert
Wendeschneidplatte

Yedek Parçaları / Spare Parts / Ersatzteile

Sıkma Vidası
Screw
Schraube

Anahtar
Allen Key
Innensechskantschlüssel

R	L	DCON	DMIN	LF	OHN	CDX	H	WF			
●	●	25	33	200	40	7	23	19.5	KG.. - 2	2504-M5x12	
●	○	20	27.5	170	30	6.5	18.3	16.5	KG.. - 3	2504-M5x16	AAL-05-4
○	○	25	33	200	40	7	23	19.5		2004-M8x1x20	
●	○	40	50	300	55	8	37.5	28	KG.. - 4	2504-M5x16	
●	●	25	34	200	40	8	23	20.5			

KRLY Ucuna Uygundur. / Compatible with KRLY Insert. / Kompatibel mit KRLY Wendeplatten.

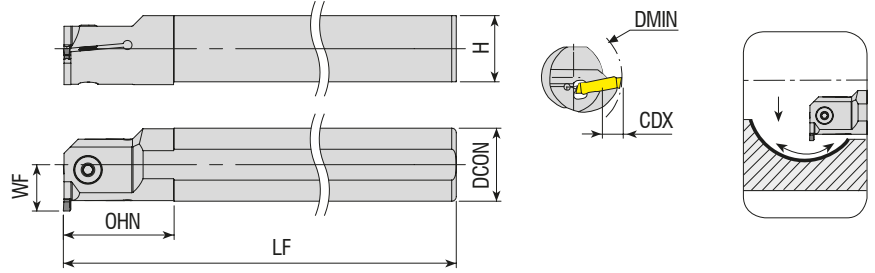

Takım Kodu
Ordering Code
Bestell-Bezeichnung

Stok
Stock
Lager

Takım Ölçüleri (mm)
Dimension (mm)
Abmessung (mm)

Kesici Uç
Insert
Wendeschneidplatte

Yedek Parçaları / Spare Parts / Ersatzteile

Sıkma Vidası
Screw
Schraube

Anahtar
Allen Key
Innensechskantschlüssel

R	L	DCON	DMIN	LF	OHN	CDX	H	WF			
●	●	25	34	200	40	8	23	20.5	S229 - 3	2504-M5x16	AAL-05-4
●	●	32	40	250	50	7	30	23		2004-M8x1x20	
●	●	40	48	300	55	7	37.5	27	S229 - 4	2504-M5x16	AAL-05-4
●	●	25	34	200	40	8	23	20.5		2004-M8x1x20	
●	●	32	40	250	50	7	30	23	S229 - 5	2504-M5x16	AAL-05-4
●	○	40	48	300	55	7	37.5	27		2004-M8x1x20	
●	●	25	34	200	40	8	23	20.5	S229 - 5	2504-M5x16	AAL-05-4
●	○	32	40	250	50	7	30	23		2004-M8x1x20	
●	○	40	48	300	55	7	37.5	27			

R: Sağ / Right / Rechts L: Sol/Left/Links

● Stokta / In Stock / Auf Lager ○ Stokta Yok / Non Stock Item / Kein Lagerartikel, Lieferzeit auf Anfrage
HRN Ucuna Uygundur. / Compatible with HRN Insert. / Kompatibel mit HRN Wendeplatten.

Sipariş Örneği/Ordering Example/Bestellbeispiel
1 ad./pcs./stück Aikt-KG-R-25-2-T7

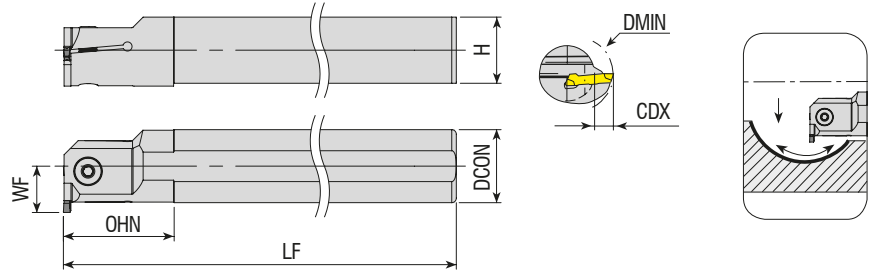

Takım Kodu Ordering Code Bestell-Bezeichnung	Stok Stock Lager		Takım Ölçüleri (mm) Dimension (mm) Abmessung (mm)							Kesici Uç Insert Wendeschneidplatte	Yedek Parçaları / Spare Parts / Ersatzteile	
	R	L	DCON	DMIN	LF	OHN	CDX	H	WF		Sıkma Vidası Screw Schraube	Anahtar Allen Key Innenschlüssel
AIKT-HK-R/L-20-2-T6	●	●	20	26	170	30	6	18.3	16	S224 - 2	2503-M4x12	AAL-03-3
AIKT-HK-R/L-25-2-T6	●	○	25	32	200	40	6	23	18.5		2504-M5x16	
AIKT-HK-R/L-20-3-T6	●	○	20	27	170	30	6	18.3	16	S224 - 3	2504-M5x12	AAL-05-4
AIKT-HK-R/L-25-3-T6	●	●	25	32	200	40	6	23	18.5		2504-M5x16	
AIKT-HK-R/L-32-3-T6	●	●	32	39	250	50	6	30	22	S224 - 4	2004-M8x1x20	AAL-05-4
AIKT-HK-R/L-20-4-T6	●	○	20	27	170	30	6	18.3	16		2504-M5x12	
AIKT-HK-R/L-25-4-T6	●	○	25	32	200	40	6	23	18.5	S224 - 4	2504-M5x16	AAL-05-4
AIKT-HK-R/L-32-4-T6	●	○	32	39	250	50	6	30	22		2004-M8x1x20	
AIKT-HS223-R/L-20-2-T5	●	○	20	26	170	33	5	18.3	15	S223 - 2	2503-M4x12	AAL-03-3
AIKT-HS223-R/L-25-2-T5	●	○	25	31	200	40	5	23	17.5		2504-M5x16	
AIKT-HS223-R/L-20-3-T6	●	○	20	27	170	33	6	18.3	16	S223 - 3	2504-M5x12	AAL-05-4
AIKT-HS223-R/L-25-3-T6	●	○	25	32	200	40	6	23	18.5		2504-M5x16	

HRN Ucuna Uygunur. / Compatible with HRN Insert. / Kompatibel mit HRN Wendepplatten.

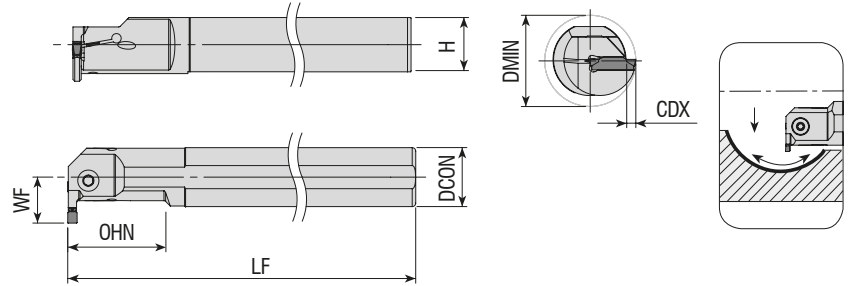

Takım Kodu Ordering Code Bestell-Bezeichnung	Stok Stock Lager		Takım Ölçüleri (mm) Dimension (mm) Abmessung (mm)							Kesici Uç Insert Wendeschneidplatte	Yedek Parçaları / Spare Parts / Ersatzteile	
	R	L	DCON	DMIN	LF	OHN	CDX	H	WF		Sıkma Vidası Screw Schraube	Anahtar Allen Key Innenschlüssel
AIKT-KM-R/L-20-2-T7	●	●	20	25	170	40	7	18.3	13	A4. - 2	2503-M4x12	AAL-03-3
AIKT-KM-R/L-20-3-T7	●	○	20	25	170	40	7	18.3	13		2504-M5x12	AAL-05-4
AIKT-KM-R/L-25-3-T10	●	●	25	32	200	50	10	23	17	A4. - 3	2505-M6x16	AAL-07-5
AIKT-KM-R/L-32-3-T12	●	●	32	40	250	64	12	30	22		2505-M6x20	AAL-05-4
AIKT-KM-R/L-40-3-T12	●	●	40	48	300	80	12	37.5	27	A4. - 4	2504-M5x12	AAL-05-4
AIKT-KM-R/L-20-4-T7	●	○	20	25	170	40	7	18.3	13		2504-M5x14	
AIKT-KM-R/L-32-4-T12.2-H	●	○	32	40	190	104	12.2	31	22			

R: Sağ / Right / Rechts L: Sol/Left/Links

● Stokta / In Stock / Auf Lager ○ Stokta Yok / Non Stock Item / Kein Lagerartikel, Lieferzeit auf Anfrage
KNMTL Ucuna Uygunur. / Compatible with KNMTL Insert. / Kompatibel mit KNMTL Wendepplatten.

Sipariş Örneği/Ordering Example/Bestellbeispiel

1 ad./pcs./stück AIKT-HK-R-20-2-T6

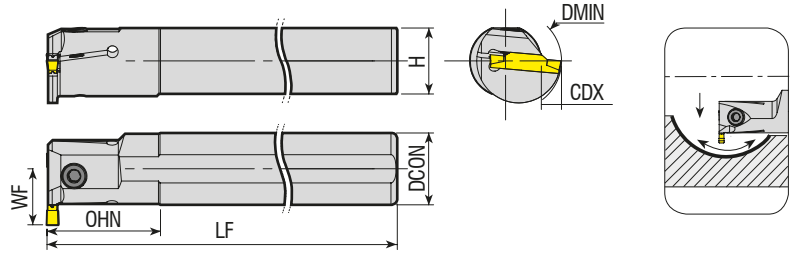

Takım Kodu Ordering Code Bestell-Bezeichnung	Stok Stock Lager		Takım Ölçüleri (mm) Dimension (mm) Abmessung (mm)							Kesici Uç Insert Wendeschneidplatte	Yedek Parçaları / Spare Parts / Ersatzteile		
	R	L	DCON	DMIN	LF	OHN	CDX	H	WF		Sıkma Vidası Screw Schraube	Anahtar Allen Key Innensechskantschlüssel	
AIKT-123-R/L-20-2-T6	●	○	20	32	170	30	6	18.3	16	123 - 2		2503-M4x12	AAL-03-3
AIKT-123-R/L-25-2-T6	●	○	25	32	200	40	6	18.3	18.5			2504-M5x12	
AIKT-123-R/L-32-2-T7	●	○	32	41	250	45	7	30	23			2004-M8x1x20	
AIKT-123-R/L-20-3-T6	●	○	20	32	170	30	6	18.3	16	123 - 3		2504-M5x16	AAL-05-4
AIKT-123-R/L-25-3-T7	●	○	25	32	200	40	7	23	19.5			2004-M8x1x20	
AIKT-123-R/L-32-3-T9	●	○	32	41	250	50	9	30	25			2504-M5x16	
AIKT-123-R/L-20-4-T8	●	○	20	29	170	30	8	18.3	18	123 - 4		2504-M5x16	AAL-05-4
AIKT-123-R/L-25-4-T7	●	○	25	32	200	40	7	23	19.5			2004-M8x1x20	
AIKT-123-R/L-32-4-T7	●	●	32	41	250	45	7	30	23			2504-M5x16	
AIKT-123-R/L-32-4-T10	●	○	32	43	250	50	10	30	26	123 - 5		2504-M5x16	AAL-05-4
AIKT-123-R/L-25-5-T8	●	○	25	34	200	40	8	23	20.5			2004-M8x1x20	
AIKT-123-R/L-32-5-T11	●	●	32	43	250	50	11	30	27			2004-M8x1x20	

SNDVK Ucuna Uygundur. / Compatible with SNDVK Insert. / Kompatibel mit SNDVK Wendeplatten.

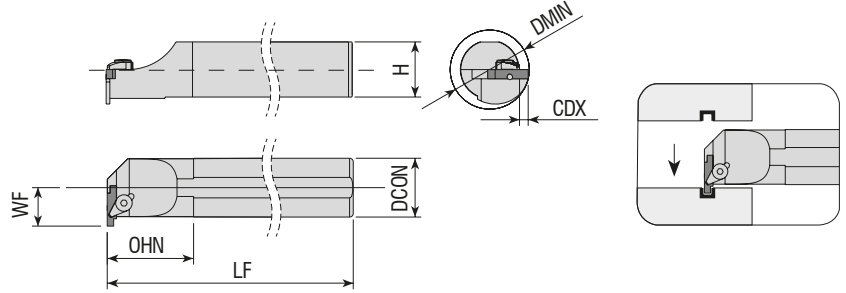

Takım Kodu Ordering Code Bestell-Bezeichnung	Stok Stock Lager		Takım Ölçüleri (mm) Dimension (mm) Abmessung (mm)							Kesici Uç Insert Wendeschneidplatte	Yedek Parçaları / Spare Parts / Ersatzteile							
	R	L	DCON	DMIN	LF	OHN	CDX	H	WF		Baskı Parçası Wedge Clamp Spannpratze	Sıkma Vidası Screw Schraube	Pim Pin Stift	Anahtar Allen Key Innensechskantschlüssel				
AIKT-154.91-R/L-16-3-T3	●	●	16	20	150	35	3	14.8	11	154.91 - 3		ACK-06	AKV-10-M6x14	APM-06	AAL-05-4			
AIKT-154.91-R/L-20-3-T4	●	●	20	25	170	38	4	18.3	14							ACK-03	AKV-21-M6x18	AAL-03-3
AIKT-154.91-R/L-25-3-T4	●	●	25	31	200	40	4	23	16.5							ACK-03	AKV-07-M6x22	AAL-03-3
AIKT-154.91-R/L-25-5-T5	●	●	25	31	200	45	5	23	17.5	154.91 - 5		ACK-03	AKV-07-M6x22	APM-06	AAL-03-3			
AIKT-154.91-R/L-32-5-T5	●	●	32	38	250	50	5	30	21									

R: Sağ / Right / Rechts L: Sol/Left/Links

● Stokta / In Stock / Auf Lager ○ Stokta Yok / Non Stock Item / Kein Lagerartikel, Lieferzeit auf Anfrage
SNDVK Ucuna Uygundur. / Compatible with SNDVK Insert. / Kompatibel mit SNDVK Wendeplatten.

Sipariş Örneği/Ordering Example/Bestellbeispiel
1 ad./pcs./stück AIKT-123-R-20-2-T6

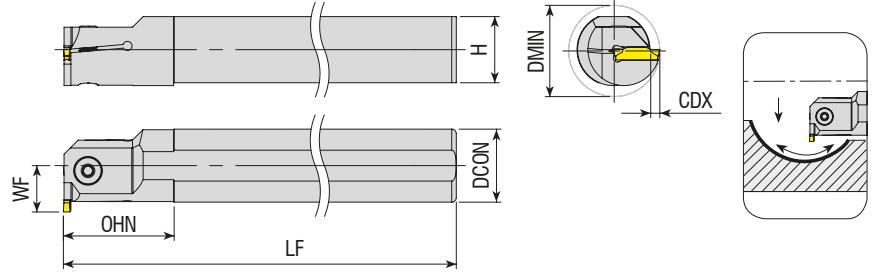

Takım Kodu Ordering Code Bestell-Bezeichnung	Stok Stock Lager		Takım Ölçüleri (mm) Dimension (mm) Abmessung (mm)							Kesici Uç Insert Wendeschneidplatte	Yedek Parçaları / Spare Parts / Ersatzteile	
	R	L	DCON	DMIN	LF	OHN	CDX	H	WF		Sıkma Vidası Screw Schraube	Anahtar Allen Key Innerschraubenschlüssel
AIKT-ZCC2-R/L-16-2-T4	●	○	16	21	150	28	4	14.8	12	Z.BD - 2	2503-M4x10	AAL-03-3
AIKT-ZCC2-R/L-20-3-T5	●	●	20	27	170	30	5	18.3	15		Z.FD - 3	
AIKT-ZCC2-R/L-20-3-T8	●	○	20	29	170	30	8	18.3	18	2504-M5x16		
AIKT-ZCC2-R/L-25-3-T5	●	○	25	31	200	40	5	23	17.5	2004-M8x1x20		
AIKT-ZCC2-R/L-25-3-T10	●	○	25	36	200	40	10	23	22.5	2504-M5x12		
AIKT-ZCC2-R/L-32-3-T6	●	○	32	39	250	50	6	30	22	2504-M5x16		
AIKT-ZCC2-R/L-32-3-T8	●	○	32	41	250	50	8	30	24	2004-M8x1x20		
AIKT-ZCC2-R/L-32-3-T13	●	○	32	46	250	50	13	30	29	2504-M5x12		
AIKT-ZCC2-R/L-40-3-T12	●	○	40	53	300	55	12	37.5	32	2504-M5x16		
AIKT-ZCC2-R/L-25-4-T6	●	○	25	32	200	40	6	23	18.5	Z.GD - 4	2004-M8x1x20	
AIKT-ZCC2-R/L-32-4-T7	●	○	32	40	250	50	7	30	23			
AIKT-ZCC2-R/L-32-4-T8	●	○	32	41	250	50	8	30	24	Z.HD - 5	2004-M8x1x20	
AIKT-ZCC2-R/L-32-4-T10	●	○	32	43	250	50	10	30	26			
AIKT-ZCC2-R/L-32-5-T7	●	○	32	40	250	50	7	30	23	Z.HD - 5	2004-M8x1x20	
AIKT-ZCC2-R/L-32-5-T8	●	○	32	41	250	50	8	30	24			
AIKT-ZCC2-R/L-40-5-T8	●	○	40	49	300	55	8	37.5	28			
AIKT-ZCC2-R/L-40-5-T10	●	○	40	51	300	55	10	37.5	30			

ZCC Ucuna Uygundur. / Compatible with ZCC Insert. / Kompatibel mit ZCC Wendepplatten.

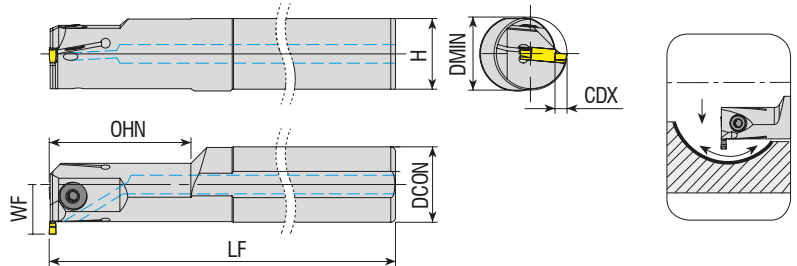

Takım Kodu Ordering Code Bestell-Bezeichnung	Stok Stock Lager		Takım Ölçüleri (mm) Dimension (mm) Abmessung (mm)							Kesici Uç Insert Wendeschneidplatte	Yedek Parçaları / Spare Parts / Ersatzteile	
	R	L	DCON	DMIN	LF	OHN	CDX	H	WF		Sıkma Vidası Screw Schraube	Anahtar Allen Key Innerschraubenschlüssel
AIKT-TD-R-16-2-T8.5-H	●	○	16	25	150	28	8.5	14.8	16.5	TD-2	2503-M4x10	AAL-03-3
AIKT-TD-R-20-3-T6-H	●	○	20	25	170	40	6	18.3	16	TD-3	2504-M5x12	AAL-05-4
AIKT-TD-R-25-3-T6-H	●	○	25	25	200	40	6	23	18.5		2004-M8x1x20	
AIKT-TD-R-32-3-T5-H	●	○	32	31	250	60	5	30	21			

R: Sağ / Right / Rechts L: Sol/Left/Links

● Stokta / In Stock / Auf Lager ○ Stokta Yok / Non Stock Item / Kein Lagerartikel, Lieferzeit auf Anfrage
TGTC Ucuna Uygundur. / Compatible with TGTC Insert. / Kompatibel mit TGTC Wendepplatten.

Sipariş Örneği/Ordering Example/Bestellbeispiel
1 ad./pcs./stück AIKT-ZCC-R-20-3-T5

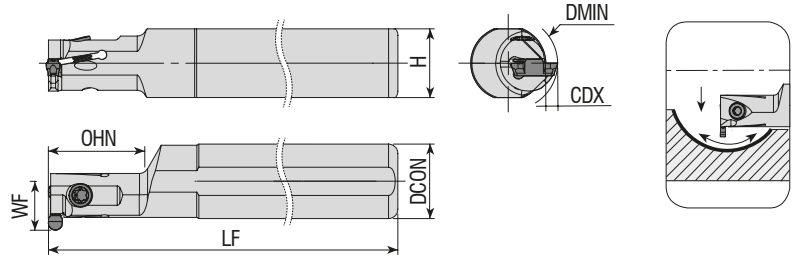

Takım Kodu Ordering Code Bestell-Bezeichnung	Stok Stock Lager		Takım Ölçüleri (mm) Dimension (mm) Abmessung (mm)							Kesici Uç Insert Wendeschneidplatte	Yedek Parçaları / Spare Parts / Ersatzteile	
	R	L	DCON	DMIN	LF	OHN	CDX	H	WF		Sıkma Vidası Screw Schraube	Anahtar Allen Key Innerschlüsselschlüssel
AIKT-IGE-R/L-10-2-T3-H	●	○	10	11.5	125	25	3	9	8.3	GEPI - 2	3008-M3x8	80-T08
AIKT-IGE-R/L-16-2-T3-D11.5	●	○	16	11.5	125	20	3	14.8	11.1			
AIKT-IGE-R/L-16-2-T2.5-H	●	●	16	13	125	20	2.5	14.8	10.5	GEPI - 3	1315-M4x11	80-T15
AIKT-IGE-R/L-16-3-T2.5-H	●	○	16	13	125	20	2.5	14.8	10.5			
AIKT-IGE-R/L-16-3-T2.5-D20	●	○	16	20	125	28	2.5	14.8	10.5			

ISCR Ucuna Uygun. / Compatiple with ISCR Insert. / Kompatibel mit ISCR Wendeplatten.

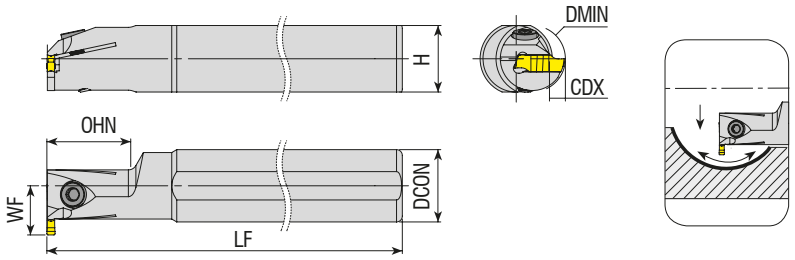

Takım Kodu Ordering Code Bestell-Bezeichnung	Stok Stock Lager		Takım Ölçüleri (mm) Dimension (mm) Abmessung (mm)							Kesici Uç Insert Wendeschneidplatte	Yedek Parçaları / Spare Parts / Ersatzteile	
	R	L	DCON	DMIN	LF	OHN	CDX	H	WF		Sıkma Vidası Screw Schraube	Anahtar Allen Key Innerschlüsselschlüssel
AIKT-IGI-R/L-20-3-T4	●	●	20	20	170	25	4	18.3	14.5	GIMIY / GIPI - 3	1020-M5x14	80-T20
AIKT-IGI-R/L-25-3-T5	●	●	25	23	200	30	5	23	17		2504-M5x16	
AIKT-IGI-R/L-32-3-T5	●	●	32	31	250	30	5	30	21		2004-M8x1x20	AAL-05-4
AIKT-IGI-R/L-40-3-T5	●	○	40	50	300	50	5	37.5	25	GIMIY / GIPI - 4	1020-M5x14	80-T20
AIKT-IGI-R/L-20-4-T4	●	●	20	20	170	25	4	18.3	14.5		GIMIY / GIPI - 5	2504-M5x16
AIKT-IGI-R/L-25-5-T10	●	○	25	32	200	25	10	23	22.5	GIMIY / GIPI - 5		2504-M5x16
AIKT-IGI-R/L-25-5-T15	●	○	25	37	200	25	15	23	27.5			

R: Sağ / Right / Rechts L: Sol/Left/Links

● Stokta / In Stock / Auf Lager ○ Stokta Yok / Non Stock Item / Kein Lagerartikel, Lieferzeit auf Anfrage
ISCR Ucuna Uygun. / Compatiple with ISCR Insert. / Kompatibel mit ISCR Wendeplatten.

Sipariş Örneği/Ordering Example/Bestellbeispiel
1 ad./pcs./stück AIKT-IGE-R-10-2-T3-H

Note: "OHN" boyunu D min çapa göre verilmiştir.

Note: Lengths of "OHN" are given according to D min diameter.
Hinweis: Maß "OHN" soll identisch mit Dmin sein

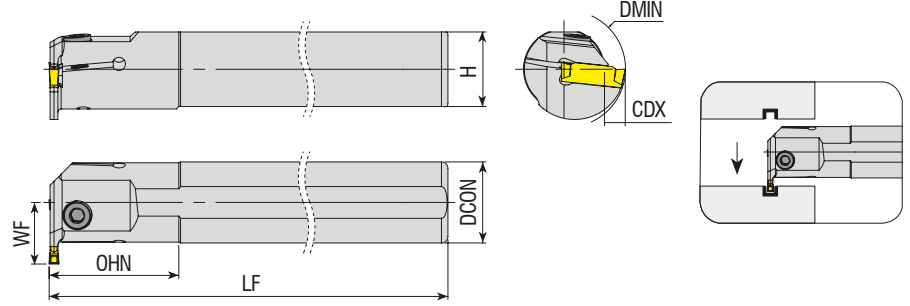

Takım Kodu Ordering Code Bestell-Bezeichnung	Stok Stock Lager		Takım Ölçüleri (mm) Dimension (mm) Abmessung (mm)							Kesici Uç Insert Wendeschneidplatte	Yedek Parçaları / Spare Parts / Ersatzteile	
	R	L	DCON	DMIN	LF	OHN	CDX	H	WF		Sıkma Vidası Screw Schraube	Anahtar Allen Key Innerschlüssel
AIKT-I-R/L-20-3-T5	●	●	20	26	170	25	5	18.3	15.5	DGN - 3	2504-M5x12	AAL-05-4
AIKT-I-R/L-25-3-T6	●	●	25	32	200	40	6	23	19		2504-M5x16	

ISCR Ucuna Uygunudur. / Compatible with ISCR Insert. / Kompatibel mit ISCR Wendeplatten.

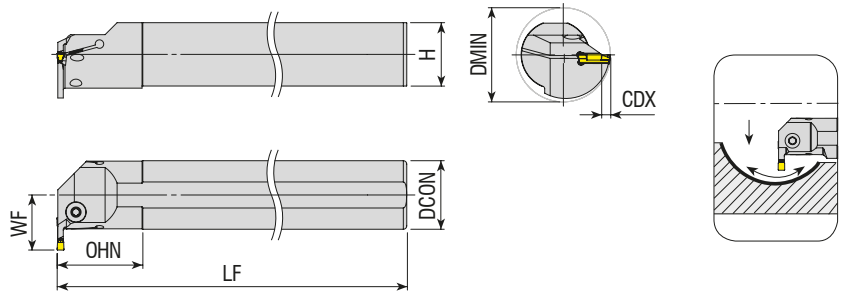

Takım Kodu Ordering Code Bestell-Bezeichnung	Stok Stock Lager		Takım Ölçüleri (mm) Dimension (mm) Abmessung (mm)							Kesici Uç Insert Wendeschneidplatte	Yedek Parçaları / Spare Parts / Ersatzteile	
	R	L	DCON	DMIN	LF	OHN	CDX	H	WF		Sıkma Vidası Screw Schraube	Anahtar Allen Key Innerschlüssel
AIKT-IG-R/L-25-4-T10-H	●	●	25	36	200	40	10	23	22.7	DGN / GRP - 4	2504-M5x16	AAL-05-4
AIKT-IG-R/L-32-4-T10-H	●	●	32	43	250	45	10	30	26.2		2004-M8x1x20	
AIKT-IG-R/L-40-4-T12-H	●	●	40	53	300	50	12	37.5	32.2	DGN / GRP - 5	2504-M5x16	AAL-05-4
AIKT-IG-R/L-25-5-T10-H	●	○	25	36	200	40	10	23	22.7		2004-M8x1x20	
AIKT-IG-R/L-32-5-T10-H	●	○	32	43	250	45	10	30	26.2			
AIKT-IG-R/L-40-5-T12-H	●	○	40	53	250	50	12	37.5	32.2			
AIKT-IG-R/L-50-5-T12-H	●	○	50	63	300	60	12	47	37.2			

R: Sağ / Right / Rechts L: Sol/Left/Links
● Stokta / In Stock / Auf Lager ○ Stokta Yok / Non Stock Item / Kein Lagerartikel, Lieferzeit auf Anfrage
ISCR Ucuna Uygunudur. / Compatible with ISCR Insert. / Kompatibel mit ISCR Wendeplatten.

Sipariş Örneği/Ordering Example/Bestellbeispiel
1 ad./pcs./stück AIKT-I-R-20-3-T5

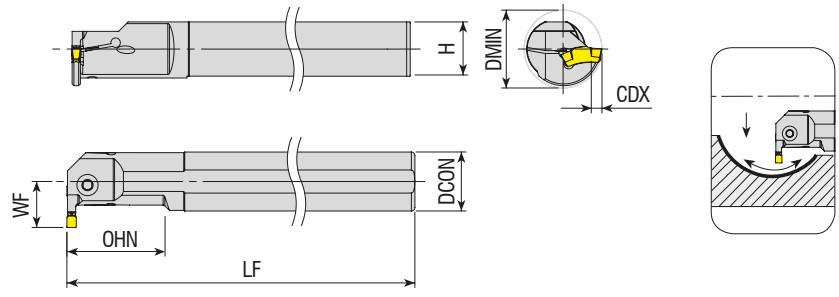

Takım Kodu Ordering Code Bestell-Bezeichnung	Stok Stock Lager		Takım Ölçüleri (mm) Dimension (mm) Abmessung (mm)							Kesici Uç Insert Wendeschneidplatte	Yedek Parçaları / Spare Parts / Ersatzteile	
	R	L	DCON	DMIN	LF	OHN	CDX	H	WF		Sıkma Vidası Screw Schraube	Anahtar Allen Key Innenschlüssel
AIKT-ITG-R/L-16-3-T6-H	●	●	16	20	150	25	6	14.8	12	TGM. - 3	1020-M4.5X14	80-T20
AIKT-ITG-R/L-20-3-T6-H	●	●	20	25	170	32	6	18.3	14.2		1020-M4.5X16	
AIKT-ITG-R/L-25-3-T8-H	●	●	25	32	200	40	8	23	18.8		2504-M5X16	AAL-05-4
AIKT-ITG-R/L-32-3-T8-H	●	●	32	38	250	49	8	30	22		2004-M8x1x20	
AIKT-ITG-R/L-20-4-T6-H	●	●	20	25	170	33	6	18.3	14.2	TGM. - 4	1020-M4.5X16	80-T20
AIKT-ITG-R/L-25-4-T7-H	●	●	25	31	200	41	7	23	17.5		2504-M5X16	
AIKT-ITG-R/L-25-4-T9-H	●	●	25	32.5	200	41	9	23	19.5		2004-M8x1x20	AAL-05-4
AIKT-ITG-R/L-32-4-T11-H	●	●	32	42	250	50	11	30	25.5			
AIKT-ITG-R/L-40-4-T11-H	●	●	40	53	300	50	11	37.5	32	TGM. - 6.35	2004-M8x1x20	
AIKT-ITG-R/L-32-6.35-T17.5-H	●	●	32	57	250	50	17.5	30	29			

ISCR Ucuna Uygun. / Compatible with ISCR Insert. / Kompatibel mit ISCR Wendeplatten.

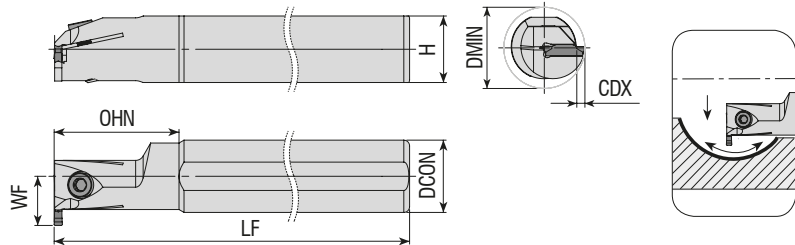

Takım Kodu Ordering Code Bestell-Bezeichnung	Stok Stock Lager		Takım Ölçüleri (mm) Dimension (mm) Abmessung (mm)							Kesici Uç Insert Wendeschneidplatte	Yedek Parçaları / Spare Parts / Ersatzteile	
	R	L	DCON	DMIN	LF	OHN	CDX	H	WF		Sıkma Vidası Screw Schraube	Anahtar Allen Key Innenschlüssel
AIKT-GP-R/L-20-2-T4	●	○	20	25	170	30	4	18.3	14.5	GP - 2	2503-M4x12	AAL-03-3
AIKT-GP-R/L-25-2-T6	●	○	25	32	200	40	6	23	18.5			
AIKT-GP-R/L-20-3-T6	●	○	20	27	170	30	6	18.3	16	GP - 3	2504-M5x16	AAL-05-4
AIKT-GP-R/L-25-3-T6	●	○	25	32	200	40	6	23	18.5			
AIKT-GP-R/L-32-3-T6	●	○	32	39	250	50	6	30	22	2004-M8x1x20		
AIKT-GP-R/L-20-4-T6	●	○	20	27	170	30	6	18.3	16	GP - 4	2504-M5x16	
AIKT-GP-R/L-25-4-T6	●	○	25	32	200	40	6	23	18.5		2004-M8x1x20	
AIKT-GP-R/L-32-4-T6	●	○	32	39	250	50	6	30	22			

R: Sağ / Right / Rechts L: Sol/Left/Links

● Stokta / In Stock / Auf Lager ○ Stokta Yok / Non Stock Item / Kein Lagerartikel, Lieferzeit auf Anfrage
PLBT Ucuna Uygun. / Compatible with PLBT Insert. / Kompatibel mit PLBT Wendeplatten.

Sipariş Örneği/Ordering Example/Bestellbeispiel
1 ad./pcs./stück AIKT-ITG-R-16-3-T6-H

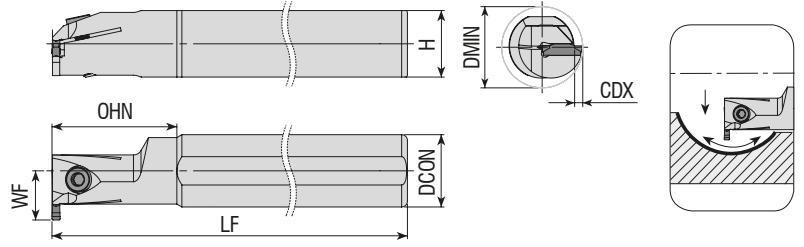

Takım Kodu Ordering Code Bestell-Bezeichnung	Stok Stock Lager		Takım Ölçüleri (mm) Dimension (mm) Abmessung (mm)							Kesici Uç Insert Wendeschneidplatte	Yedek Parçaları / Spare Parts / Ersatzteile	
	R	L	DCON	DMIN	LF	OHN	CDX	H	WF		Sıkma Vidası Screw Schraube	Anahtar Allen Key Innensechskantschlüssel
AIKT-SGC-R/L-25-3-T6	●	○	25	32	200	40	6	23	18.5	GCM N30	2504-M5x16	AAL-05-4
AIKT-SGC-R/L-32-3-T6	●	○	32	39	250	50	6	30	22		2004-M8x1x20	
AIKT-SGC-R/L-40-3-T6	●	○	40	47	300	55	6	37.5	26			

SMTM Ucuna Uygunur. / Compatible with SMTM Insert. / Kompatibel mit SMTM Wendeplatten.

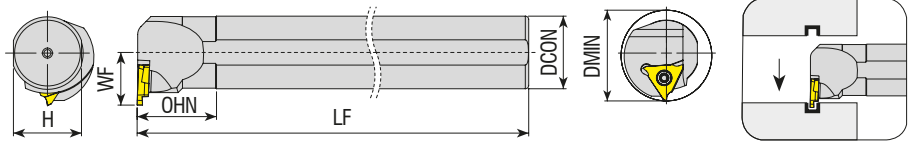

Takım Kodu Ordering Code Bestell-Bezeichnung	Stok Stock Lager		Takım Ölçüleri (mm) Dimension (mm) Abmessung (mm)							Kesici Uç Insert Wendeschneidplatte	Yedek Parçaları / Spare Parts / Ersatzteile	
	R	L	DCON	DMIN	LF	OHN	CDX	H	WF		Sıkma Vidası Screw Schraube	Anahtar Allen Key Innensechskantschlüssel
AIKT-QC11-R/L-20-(0.5-1.8)	●	○	20	16	150	40	-	18.3	12	QC11R/L (0.50-1.80)	3008 M2.5x6	80-T08
AIKT-QC16-R/L-20-(0.5-1.8)	○	○	20	25	150	35	-	18.3	13.5	QC16R/L (0.50-1.80)	4015-M3.5x10	80-T15
AIKT-QC16-R/L-20-(0.5-2.5)	●	○	20	25	150	35	-	18.3	13.5	QC16R/L (0.50-2.50)		
AIKT-QC22-R/L-25-(1-2.3)	○	○	25	35	150	35	-	23	18.2	QC22R/L (1.00-2.30)	1120 M5x20	80-T20
AIKT-QC22-R/L-25-(2.5-3.3)	●	○	25	35	150	35	-	23	18.2	QC22R/L (2.50-3.30)		
AIKT-QC22-R/L-25-(3.3-4.8)	●	○	25	35	150	35	-	23	18.2	QC22R/L (3.30-4.80)		
AIKT-QC22-R/L-32-(1-2.3)	○	○	32	45	150	35	-	30	23.2	QC22R/L (1.00-2.30)		

R: Sağ / Right / Rechts L: Sol/Left/Links

● Stokta / In Stock / Auf Lager ○ Stokta Yok / Non Stock Item / Kein Lagerartikel, Lieferzeit auf Anfrage

ZCC Ucuna Uygunur. / Compatible with ZCC Insert. / Kompatibel mit ZCC Wendeplatten.

Sipariş Örneği/Ordering Example/Bestellbeispiel

1 ad./pcs./stück AIKT-SGC-R-25-3-T6

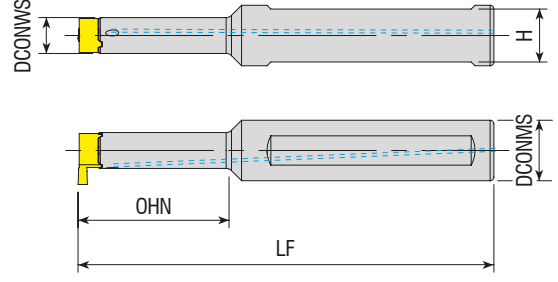

Takım Kodu Ordering Code Bestell-Bezeichnung	Stok Stock Lager	Takım Ölçüleri (mm) Dimension (mm) Abmessung (mm)					Kesici Uç Insert Wendeschneidplatte	Yedek Parçaları / Spare Parts / Ersatzteile	
		DCONMS	DCONWS	LF	OHN	H		Sıkma Vidası Screw Schraube	Anahtar Allen Key Innerschraubschlüssel
AIKT-MB07-A16-090-15	●	16	7.4	90	15	14	MB - 07	4008-M3x8	80-T08
AIKT-MB07-A16-090-22	●	16	7.4	90	22	14			
AIKT-MB09-A16-090-19	●	16	9.5	90	19	14	MB - 09	4015-M4x11	80-T15
AIKT-MB09-A16-095-28	●	16	9.5	95	28	14			
AIKT-MB09-A16-110-40	●	16	9.5	110	40	14			

R: Sağ / Right / Rechts L: Sol/Left/Links

● Stokta / In Stock / Auf Lager ○ Stokta Yok / Non Stock Item / Kein Lagerartikel, Lieferzeit auf Anfrage
SNDVK Ucuna Uygundur. / Compatible with SNDVK Insert. / Kompatibel mit SNDVK Wendepfatten.

Sipariş Örneği/Ordering Example/Bestellbeispiel
1 ad./pcs./stück AIKT-MB07-A16-090-15



konusulan
the spoken kalite...
quality...





DELİK DELME ve İŞLEME TAKIMLARI
DRILLING and HOLEMAKING TOOLS
BOHRWERKZEUGE





*konusulan
the spoken kalite...
quality...*

U-DRILL

TAKMA UÇLU MATKAPLAR
U-DRILL SYSTEM
VOLLBOHRER





AKKO **A** **TUM** **16** x **D3**

S **P** **G** **T** **06** **02** **04**

2 Kesici Stili / Cutter Style
Werkzeugtyp

TUM: Takma Uçlu Matkap
U-Drill
Vollbohrer

3 Takım Çapı / Tool Diameter
Werkzeugdurchmesser

4 Delme Derinliği / Drilling Depth
Bohrtiefe

5 Uç Şekli / Insert Form
Plattenform

W **S**

8 Uç Tipi / Insert Type
Plattentyp

A J T
 $\beta = 70-90^\circ$ $\beta = 70-90^\circ$ $\beta = 40-60^\circ$

B M
 $\beta = 70-90^\circ$

C N
 $\beta = 70-90^\circ$

F Q
 $\beta = 40-60^\circ$

G R
 $\beta = 70-90^\circ$

H X **Özel
Special
Sonder**

U
 $\beta = 40-60^\circ$

W
 $\beta = 40-60^\circ$

10 Kalınlık / Thickness
Dicke

01 s = 1.59
T1 s = 1.98
02 s = 2.38
T2 s = 2.78
03 s = 3.18
T3 s = 3.97
04 s = 4.76
05 s = 5.56
06 s = 6.35
07 s = 7.94
09 s = 9.52

6 Serbest Uç Açısı / Clearance angle of Insert
Freiwinkel der Wendeschneidplatte

C **P**

7 Toleranslar / Tolerance Classes
Toleranzen

	IC	M	S
A	± 0.025	± 0.005	± 0.025
C	± 0.025	± 0.013	± 0.025
E	± 0.025	± 0.025	± 0.025
F	± 0.013	± 0.005	± 0.025
G	± 0.025	± 0.025	± 0.130
H	± 0.013	± 0.013	± 0.025
J	± 0.05-0.15	± 0.005	± 0.025
K	± 0.05-0.15	± 0.013	± 0.025
L	± 0.05-0.15	± 0.025	± 0.025
M	± 0.05-0.15	± 0.08-0.20	± 0.130
N	± 0.05-0.15	± 0.08-0.20	± 0.025
U	± 0.08-0.25	± 0.13-0.38	± 0.130

IC : Daire Ölçüsü / Inscribed Circle / Kreisgröße
M : Şekle Göre / Refer to Figure / Siehe Abbildung
S : Kalınlık / Thickness / Dicke

9 Kesme Kenar Uzunluğu / Cutting Edge Length
Schneidkantenlänge

11 Köşe Konfigurasyonu / Corner Radius
Eckenradius

01 r = 0.1
02 r = 0.2
04 r = 0.4
08 r = 0.8
12 r = 1.2
16 r = 1.6
24 r = 2.4



Delme Derinliği
Drilling Depth
Bohrtiefe

= 2xÇap
= 2xDiameter
= 2xDurchmesser

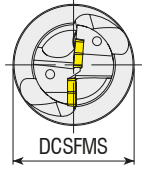
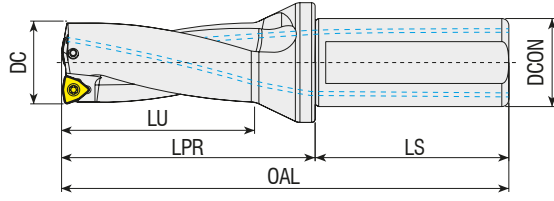

Takım Kodu Ordering Code Bestell-Bezeichnung	Stok Stock Lager	Takım Ölçüleri (mm) Dimension (mm) Abmessung (mm)							Kesici Uç Insert Wendeschneidplatte	Yedek Parçaları / Spare Parts / Ersatzteile	
		DC	DCON	DCSFMS	OAL	LU	LPR	LS		Sıkma Vidası Screw Schraube	Tork Anahtar Torx Key Torx-Schlüssel
ATUM 16XD2 WCM. 030208	●	16	25	34	110	32	54	56	WCM. 030208	3008-M2.5x6	80-T08
ATUM 16.5XD2 WCM. 030208	●	16.5	25	34	110	32	54	56			
ATUM 17XD2 WCM. 030208	●	17	25	34	112	34	56	56			
ATUM 17.5XD2 WCM. 030208	●	17.5	25	34	112	34	56	56			
ATUM 18XD2 WCM. 030208	●	18	25	34	114	36	58	56			
ATUM 18.5XD2 WCM. 030208	●	18.5	25	34	114	36	58	56			
ATUM 19XD2 WCM. 030208	●	19	25	34	116	38	60	56			
ATUM 19.5XD2 WCM. 030208	●	19.5	25	34	116	38	60	56	WCM. 040208	3008-M2.5x6	80-T08
ATUM 20XD2 WCM. 040208	●	20	25	34	118	40	62	56			
ATUM 20.5XD2 WCM. 040208	●	20.5	25	34	118	40	62	56			
ATUM 21XD2 WCM. 040208	●	21	25	34	120	42	64	56			
ATUM 21.5XD2 WCM. 040208	●	21.5	25	34	120	42	64	56			
ATUM 22XD2 WCM. 040208	●	22	25	34	122	44	66	56			
ATUM 22.5XD2 WCM. 040208	●	22.5	25	34	122	44	66	56			
ATUM 23XD2 WCM. 040208	●	23	25	34	124	46	68	56	WCM. 050308	3008-M3x8	
ATUM 23.5XD2 WCM. 040208	●	23.5	25	34	124	46	68	56			
ATUM 24XD2 WCM. 050308	●	24	25	34	126	48	70	56			
ATUM 24.5XD2 WCM. 050308	●	24.5	25	34	126	48	70	56			
ATUM 25XD2 WCM. 050308	●	25	25	34	128	50	72	56			
ATUM 25.5XD2 WCM. 050308	●	25.5	25	34	128	50	72	56			
ATUM 26XD2 WCM. 050308	●	26	25	34	130	52	74	56			
ATUM 26.5XD2 WCM. 050308	●	26.5	25	34	130	52	74	56			
ATUM 27XD2 WCM. 050308	●	27	25	34	132	54	76	56			
ATUM 27.5XD2 WCM. 050308	●	27.5	25	34	132	54	76	56			
ATUM 28XD2 WCM. 050308	●	28	25	34	134	56	78	56			
ATUM 28.5XD2 WCM. 050308	●	28.5	25	34	134	56	78	56			
ATUM 29XD2 WCM. 050308	●	29	25	34	136	58	80	56			
ATUM 29.5XD2 WCM. 050308	●	29.5	25	34	136	58	80	56			

R: Sağ / Right / Rechts L: Sol/Left/Links

● Stokta / In Stock / Auf Lager ○ Stokta Yok / Non Stock Item / Kein Lagerartikel, Lieferzeit auf Anfrage
ISO Ucuna Uygundur. / Compatible with ISO Insert. / Kompatibel mit ISO Wendepplatten.

Sipariş Örneği/Ordering Example/Bestellbeispiel

1 ad./pcs./stück ATUM 16xD2 WCM. 030208

Takma Uçlu Matkap Kullanım Kılavuzu : S.329 / User's Guide For U-Drills : P.329
S.330 / Bedienungsanleitung für Vollbohrer



Delme Derinliği
Drilling Depth
Bohrtiefe

= 2xÇap
= 2xDiameter
= 2xDurchmesser

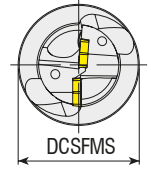
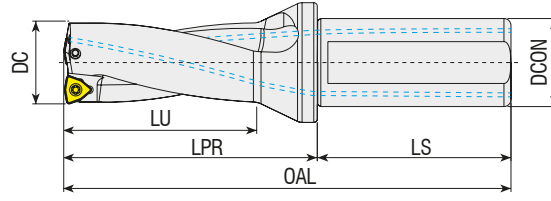

Takım Kodu
Ordering Code
Bestell-Bezeichnung

Stok
Stock
Lager

Takım Ölçüleri (mm)
Dimension (mm)
Abmessung (mm)

Kesici Uç
Insert
Wendeschneidplatte

Yedek Parçaları / Spare Parts / Ersatzteile

Sıkma Vidası
Screw
Schraube

Tork Anahtar
Torx Key
Torx-Schlüssel

DC DCON DCSFMS OAL LU LPR LS



ATUM 30XD2 WCM. 06T308

●

30

32

44

147

60

87

60

WCM. 06T308

3010-M3.5x9

80-T10

ATUM 31XD2 WCM. 06T308

●

31

32

44

149

62

89

60

ATUM 32XD2 WCM. 06T308

●

32

32

44

151

64

91

60

ATUM 33XD2 WCM. 06T308

●

33

32

44

153

66

93

60

ATUM 34XD2 WCM. 06T308

●

34

32

44

155

68

95

60

ATUM 35XD2 WCM. 06T308

●

35

32

44

157

70

97

60

ATUM 36XD2 WCM. 06T308

●

36

32

44

159

72

99

60

ATUM 37XD2 WCM. 06T308

●

37

32

44

161

74

101

60

ATUM 38XD2 WCM. 06T308

●

38

32

44

163

76

103

60

ATUM 39XD2 WCM. 06T308

●

39

32

44

165

78

105

60

ATUM 40XD2 WCM. 06T308

●

40

32

44

167

80

107

60

ATUM 41XD2 WCM. 06T308

●

41

32

44

169

82

109

60

ATUM 42XD2 WCM. 06T308

●

42

32

44

171

84

111

60

ATUM 43XD2 WCM. 06T308

●

43

32

44

173

86

113

60

ATUM 44XD2 WCM. 06T308

●

44

32

44

175

88

115

60

ATUM 45XD2 WCM. 080412

●

45

40

54

192

90

122

70

WCM. 080412

4015-M4x11

80-T15

ATUM 46XD2 WCM. 080412

●

46

40

54

194

92

124

70

ATUM 47XD2 WCM. 080412

●

47

40

54

196

94

126

70

ATUM 48XD2 WCM. 080412

●

48

40

54

198

96

128

70

ATUM 49XD2 WCM. 080412

●

49

40

54

200

98

130

70

ATUM 50XD2 WCM. 080412

●

50

40

54

202

100

132

70

ATUM 51XD2 WCM. 080412

●

51

40

54

204

102

134

70

ATUM 52XD2 WCM. 080412

●

52

40

54

206

104

136

70

ATUM 53XD2 WCM. 080412

●

53

40

54

208

106

138

70

ATUM 54XD2 WCM. 080412

●

54

40

54

210

108

140

70

ATUM 55XD2 WCM. 080412

●

55

40

54

212

110

142

70

ATUM 56XD2 WCM. 080412

●

56

40

64

214

112

144

70

ATUM 57XD2 WCM. 080412

●

57

40

64

216

114

146

70

ATUM 58XD2 WCM. 080412

●

58

40

64

218

116

148

70

ATUM 59XD2 WCM. 080412

●

59

40

64

220

118

150

70

ATUM 60XD2 WCM. 080412

●

60

40

64



Delme Derinliği
Drilling Depth
Bohrtiefe

= 3xÇap
= 3xDiameter
= 3xDurchmesser

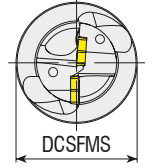
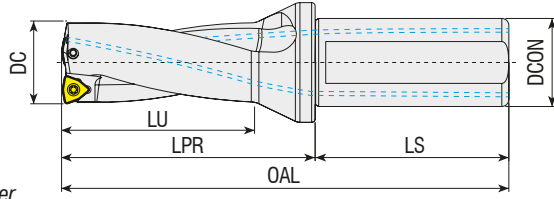

Takım Kodu Ordering Code Bestell-Bezeichnung	Stok Stock Lager	Takım Ölçüleri (mm) Dimension (mm) Abmessung (mm)							Kesici Uç Insert Wendeschneidplatte	Yedek Parçaları / Spare Parts / Ersatzteile	
		DC	DCON	DCSFMS	OAL	LU	LPR	LS		Sıkma Vidası Screw Schraube	Tork Anahtar Torx Key Torx-Schlüssel
ATUM 16XD3 WCM. 030208	●	16	25	34	126	48	70	56	WCM. 030208	3008-M2.5x6	80-T08
ATUM 16.5XD3 WCM. 030208	●	16.5	25	34	126	48	70	56			
ATUM 17XD3 WCM. 030208	●	17	25	34	129	51	73	56			
ATUM 17.5XD3 WCM. 030208	●	17.5	25	34	129	51	73	56			
ATUM 18XD3 WCM. 030208	●	18	25	34	132	54	76	56			
ATUM 18.5XD3 WCM. 030208	●	18.5	25	34	132	54	76	56			
ATUM 19XD3 WCM. 030208	●	19	25	34	135	57	79	56			
ATUM 19.5XD3 WCM. 030208	●	19.5	25	34	135	57	79	56			
ATUM 20XD3 WCM. 040208	●	20	25	34	138	60	82	56	WCM. 040208	3008-M2.5x6	80-T08
ATUM 20.5XD3 WCM. 040208	●	20.5	25	34	138	60	82	56			
ATUM 21XD3 WCM. 040208	●	21	25	34	141	63	85	56			
ATUM 21.5XD3 WCM. 040208	●	21.5	25	34	141	63	85	56			
ATUM 22XD3 WCM. 040208	●	22	25	34	144	66	88	56			
ATUM 22.5XD3 WCM. 040208	●	22.5	25	34	144	66	88	56			
ATUM 23XD3 WCM. 040208	●	23	25	34	147	69	91	56			
ATUM 23.5XD3 WCM. 040208	●	23.5	25	34	147	69	91	56			
ATUM 24XD3 WCM. 050308	●	24	25	34	150	72	94	56	WCM. 050308	3008-M3x8	
ATUM 24.5XD3 WCM. 050308	●	24.5	25	34	150	72	94	56			
ATUM 25XD3 WCM. 050308	●	25	25	34	153	75	97	56			
ATUM 25.5XD3 WCM. 050308	●	25.5	25	34	153	75	97	56			
ATUM 26XD3 WCM. 050308	●	26	25	34	156	78	100	56			
ATUM 26.5XD3 WCM. 050308	●	26.5	25	34	156	78	100	56			
ATUM 27XD3 WCM. 050308	●	27	25	34	159	81	103	56			
ATUM 27.5XD3 WCM. 050308	●	27.5	25	34	159	81	103	56			
ATUM 28XD3 WCM. 050308	●	28	25	34	162	84	106	56			
ATUM 28.5XD3 WCM. 050308	●	28.5	25	34	162	84	106	56			
ATUM 29XD3 WCM. 050308	●	29	25	34	165	87	109	56	WCM. 06T308	3010-M3.5x9	80-T10
ATUM 29.5XD3 WCM. 050308	●	29.5	25	34	165	87	109	56			
ATUM 30XD3 WCM. 06T308	●	30	32	44	177	90	117	60			
ATUM 30.5XD3 WCM. 06T308	●	30.5	32	44	177	90	117	60			
ATUM 31XD3 WCM. 06T308	●	31	32	44	180	93	120	60			
ATUM 31.5XD3 WCM. 06T308	●	31.5	32	44	180	93	120	60			
ATUM 32XD3 WCM. 06T308	●	32	32	44	183	96	123	60			
ATUM 32.5XD3 WCM. 06T308	●	32.5	32	44	183	96	123	60			
ATUM 33XD3 WCM. 06T308	●	33	32	44	186	99	126	60			
ATUM 33.5XD3 WCM. 06T308	●	33.5	32	44	186	99	126	60			
ATUM 34XD3 WCM. 06T308	●	34	32	44	189	102	129	60			
ATUM 34.5XD3 WCM. 06T308	●	34.5	32	44	189	102	129	60			

R: Sağ / Right / Rechts L: Sol/Left/Links

● Stokta / In Stock / Auf Lager ○ Stokta Yok / Non Stock Item / Kein Lagerartikel, Lieferzeit auf Anfrage
ISO Ucuna Uygunudur. / Compatible with ISO Insert. / Kompatibel mit ISO Wendeplatten.

Sipariş Örneği/Ordering Example/Bestellbeispiel
1 ad./pcs./stück ATUM 16XD3 WCM. 030208

Takma Uçlu Matkap Kullanım Kılavuzu : S 329 / User's Guide For U-Drills : P 329
S.330 / Bedienungsanleitung für Vollbohrer



Delme Derinliği
Drilling Depth
Bohrtiefe

= 3xÇap
= 3xDiameter
= 3xDurchmesser

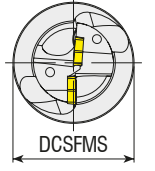
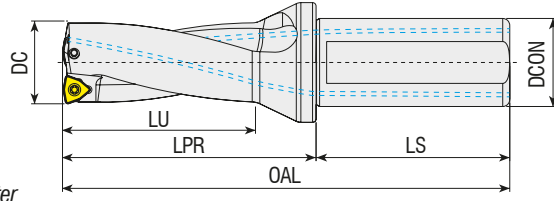

Takım Kodu
Ordering Code
Bestell-Bezeichnung

Stok
Stock
Lager

Takım Ölçüleri (mm)
Dimension (mm)
Abmessung (mm)

Kesici Uç
Insert
Wendeschneidplatte

Yedek Parçaları / Spare Parts / Ersatzteile

Sıkma Vidası
Screw
Schraube

Tork Anahtar
Torx Key
Torx-Schlüssel

DC DCON DCSFMS OAL LU LPR LS

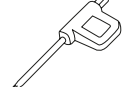

ATUM 35XD3 WCM. 06T308	●	35	32	44	192	105	132	60
ATUM 35.5XD3 WCM. 06T308	●	35.5	32	44	192	105	132	60
ATUM 36XD3 WCM. 06T308	●	36	32	44	195	108	135	60
ATUM 36.5XD3 WCM. 06T308	●	36.5	32	44	195	108	135	60
ATUM 37XD3 WCM. 06T308	●	37	32	44	198	111	138	60
ATUM 37.5XD3 WCM. 06T308	●	37.5	32	44	198	111	138	60
ATUM 38XD3 WCM. 06T308	●	38	32	44	201	114	141	60
ATUM 38.5XD3 WCM. 06T308	●	38.5	32	44	201	114	141	60
ATUM 39XD3 WCM. 06T308	●	39	32	44	204	117	144	60
ATUM 39.5XD3 WCM. 06T308	●	39.5	32	44	204	117	144	60
ATUM 40XD3 WCM. 06T308	●	40	32	44	207	120	147	60
ATUM 40.5XD3 WCM. 06T308	●	40.5	32	44	207	120	147	60
ATUM 41XD3 WCM. 06T308	●	41	32	44	210	123	150	60
ATUM 41.5XD3 WCM. 06T308	●	41.5	32	44	210	123	150	60
ATUM 42XD3 WCM. 06T308	●	42	32	44	213	126	153	60
ATUM 42.5XD3 WCM. 06T308	●	42.5	32	44	213	126	153	60
ATUM 43XD3 WCM. 06T308	●	43	32	44	216	129	156	60
ATUM 43.5XD3 WCM. 06T308	●	43.5	32	44	216	129	156	60
ATUM 44XD3 WCM. 06T308	●	44	32	44	219	132	159	60
ATUM 44.5XD3 WCM. 06T308	●	44.5	32	44	219	132	159	60
ATUM 45XD3 WCM. 080412	●	45	40	54	237	135	167	70
ATUM 45.5XD3 WCM. 080412	●	45.5	40	54	237	135	167	70
ATUM 46XD3 WCM. 080412	●	46	40	54	240	138	170	70
ATUM 47XD3 WCM. 080412	●	47	40	54	243	141	173	70
ATUM 48XD3 WCM. 080412	●	48	40	54	246	144	176	70
ATUM 49XD3 WCM. 080412	●	49	40	54	249	147	179	70
ATUM 50XD3 WCM. 080412	●	50	40	54	252	150	182	70
ATUM 51XD3 WCM. 080412	●	51	40	54	255	153	185	70
ATUM 52XD3 WCM. 080412	●	52	40	54	258	156	188	70
ATUM 53XD3 WCM. 080412	●	53	40	54	261	159	191	70
ATUM 54XD3 WCM. 080412	●	54	40	54	264	162	194	70
ATUM 55XD3 WCM. 080412	●	55	40	54	267	165	197	70
ATUM 56XD3 WCM. 080412	●	56	40	64	270	168	200	70
ATUM 57XD3 WCM. 080412	●	57	40	64	273	171	203	70
ATUM 58XD3 WCM. 080412	●	58	40	64	276	174	206	70
ATUM 59XD3 WCM. 080412	●	59	40	64	279	177	209	70
ATUM 60XD3 WCM. 080412	●	60	40	64	282	180	212	70

WCM. 06T308

3010-M3.5x9

80-T10

WCM. 080412

4015-M4x11

80-T15

R: Sağ / Right / Rechts L: Sol/Left/Links

● Stokta / In Stock / Auf Lager ○ Stokta Yok / Non Stock Item / Kein Lagerartikel, Lieferzeit auf Anfrage
ISO Uçuna Uygunudur. / Compatible with ISO Insert. / Kompatibel mit ISO Wendeplatten.

Sipariş Örneği/Ordering Example/Bestellbeispiel

1 ad./pcs./stück ATUM 35xD3 WCM. 06T308

Takma Uçlu Matkap Kullanım Kılavuzu : S 329 / User's Guide For U-Drills : P 329

S.330 / Bedienungsanleitung für Vollbohrer



Delme Derinliği
Drilling Depth
Bohrtiefe

= 4xÇap
= 4xDiameter
= 4xDurchmesser

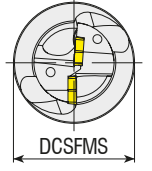
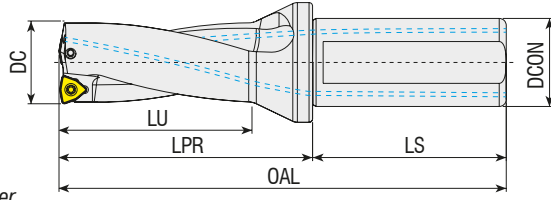

Takım Kodu Ordering Code Bestell-Bezeichnung	Stok Stock Lager	Takım Ölçüleri (mm) Dimension (mm) Abmessung (mm)							Kesici Uç Insert Wendeschneidplatte	Yedek Parçaları / Spare Parts / Ersatzteile	
		DC	DCON	DCSFMS	OAL	LU	LPR	LS		Sıkma Vidası Screw Schraube	Tork Anahtar Torx Key Torx-Schlüssel
ATUM 16XD4 WCM. 030208	●	16	25	34	142	64	86	56	WCM. 030208		
ATUM 16.5XD4 WCM. 030208	○	16.5	25	34	142	64	86	56			
ATUM 17XD4 WCM. 030208	●	17	25	34	146	68	90	56			
ATUM 17.5XD4 WCM. 030208	●	17.5	25	34	146	68	90	56			
ATUM 18XD4 WCM. 030208	●	18	25	34	150	72	94	56			
ATUM 18.5XD4 WCM. 030208	○	18.5	25	34	150	72	94	56			
ATUM 19XD4 WCM. 030208	●	19	25	34	154	76	98	56			
ATUM 19.5XD4 WCM. 030208	○	19.5	25	34	154	76	98	56			
ATUM 20XD4 WCM. 040208	●	20	25	34	158	80	102	56	WCM. 040208	3008-M2.5x6	80-T08
ATUM 20.5XD4 WCM. 040208	○	20.5	25	34	158	80	102	56			
ATUM 21XD4 WCM. 040208	●	21	25	34	162	84	106	56			
ATUM 21.5XD4 WCM. 040208	○	21.5	25	34	162	84	106	56			
ATUM 22XD4 WCM. 040208	●	22	25	34	166	88	110	56			
ATUM 22.5XD4 WCM. 040208	●	22.5	25	34	166	88	110	56			
ATUM 23XD4 WCM. 040208	●	23	25	34	170	92	114	56			
ATUM 23.5XD4 WCM. 040208	○	23.5	25	34	170	92	114	56			
ATUM 24XD4 WCM. 050308	●	24	25	34	174	96	118	56	WCM. 050308	3008-M3x8	
ATUM 24.5XD4 WCM. 050308	○	24.5	25	34	174	96	118	56			
ATUM 25XD4 WCM. 050308	●	25	25	34	178	100	122	56			
ATUM 25.5XD4 WCM. 050308	○	25.5	25	34	178	100	122	56			
ATUM 26XD4 WCM. 050308	●	26	25	34	182	104	126	56			
ATUM 26.5XD4 WCM. 050308	●	26.5	25	34	182	104	126	56			
ATUM 27XD4 WCM. 050308	●	27	25	34	186	108	130	56			
ATUM 27.5XD4 WCM. 050308	○	27.5	25	34	186	108	130	56			
ATUM 28XD4 WCM. 050308	●	28	25	34	190	112	134	56			
ATUM 28.5XD4 WCM. 050308	●	28.5	25	34	190	112	134	56			
ATUM 29XD4 WCM. 050308	●	29	25	34	194	116	138	56			
ATUM 29.5XD4 WCM. 050308	○	29.5	25	34	194	116	138	56			

R: Sağ / Right / Rechts L: Sol/Left/Links

● Stokta / In Stock / Auf Lager ○ Stokta Yok / Non Stock Item / Kein Lagerartikel, Lieferzeit auf Anfrage
ISO Ucuna Uygundur. / Compatible with ISO Insert. / Kompatibel mit ISO Wendeplatten.

Sipariş Örneği/Ordering Example/Bestellbeispiel

1 ad./pcs./stück ATUM 16xD4 WCM. 030208

Takma Uçlu Matkap Kullanım Kılavuzu : S 329 / User's Guide For U-Drills : P 329

S.330 / Bedienungsanleitung für Vollbohrer



Delme Derinliği
Drilling Depth
Bohrtiefe

= 4xÇap
= 4xDiameter
= 4xDurchmesser

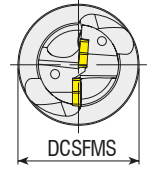
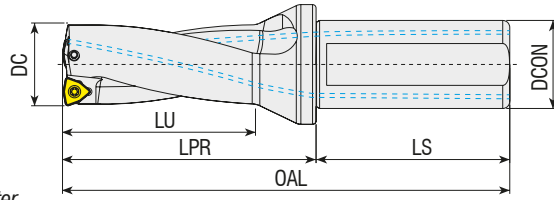

Takım Kodu Ordering Code Bestell-Bezeichnung	Stok Stock Lager	Takım Ölçüleri (mm) Dimension (mm) Abmessung (mm)							Kesici Uç Insert Wendeschneidplatte	Yedek Parçaları / Spare Parts / Ersatzteile	
		DC	DCON	DCSFMS	OAL	LU	LPR	LS		Sıkma Vidası Screw Schraube	Tork Anahtar Torx Key Torx-Schlüssel
ATUM 30XD4 WCM. 06T308	●	30	32	44	207	120	147	60	WCM. 06T308	3010-M3.5x9	80-T10
ATUM 31XD4 WCM. 06T308	●	31	32	44	211	124	151	60			
ATUM 32XD4 WCM. 06T308	●	32	32	44	215	128	155	60			
ATUM 33XD4 WCM. 06T308	●	33	32	44	219	132	159	60			
ATUM 33.5XD4 WCM. 06T308	●	33.5	32	44	219	132	159	60			
ATUM 34XD4 WCM. 06T308	●	34	32	44	223	136	163	60			
ATUM 35XD4 WCM. 06T308	●	35	32	44	227	140	167	60			
ATUM 36XD4 WCM. 06T308	●	36	32	44	231	144	171	60			
ATUM 37XD4 WCM. 06T308	●	37	32	44	235	148	175	60			
ATUM 38XD4 WCM. 06T308	●	38	32	44	239	152	179	60			
ATUM 38.5XD4 WCM. 06T308	●	38.5	32	44	239	152	179	60			
ATUM 39XD4 WCM. 06T308	●	39	32	44	243	156	183	60			
ATUM 40XD4 WCM. 06T308	●	40	32	44	247	160	187	60			
ATUM 41XD4 WCM. 06T308	●	41	32	44	251	164	191	60			
ATUM 42XD4 WCM. 06T308	●	42	32	44	255	168	195	60			
ATUM 43XD4 WCM. 06T308	●	43	32	44	259	172	199	60			
ATUM 44XD4 WCM. 06T308	●	44	32	44	263	176	203	60			
ATUM 45XD4 WCM. 080412	●	45	40	54	282	180	212	70	WCM. 080412	4015-M4x11	80-T15
ATUM 46XD4 WCM. 080412	●	46	40	54	286	184	216	70			
ATUM 47XD4 WCM. 080412	●	47	40	54	290	188	220	70			
ATUM 48XD4 WCM. 080412	●	48	40	54	294	192	224	70			
ATUM 49XD4 WCM. 080412	●	49	40	54	298	196	228	70			
ATUM 50XD4 WCM. 080412	●	50	40	54	302	200	232	70			

R: Sağ / Right / Rechts L: Sol/Left/Links
● Stokta / In Stock / Auf Lager ○ Stokta Yok / Non Stock Item / Kein Lagerartikel, Lieferzeit auf Anfrage
ISO Ucuna Uygunudur. / Compatible with ISO Insert. / Kompatibel mit ISO Wendepplatten.

Sipariş Örneği/Ordering Example/Bestellbeispiel
1 ad./pcs./stück ATUM 30xD4 WCM. 06T308
Takma Uçlu Matkap Kullanım Kılavuzu : S 329 / User's Guide For U-Drills : P 329
S.330 / Bedienungsanleitung für Vollbohrer





Delme Derinliği
Drilling Depth
Bohrtiefe

= 2xÇap
= 2xDiameter
= 2xDurchmesser

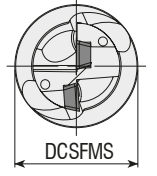
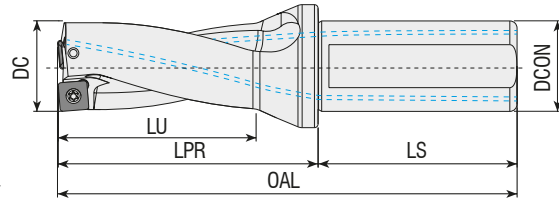

Takım Kodu Ordering Code Bestell-Bezeichnung	Stok Stock Lager	Takım Ölçüleri (mm) Dimension (mm) Abmessung (mm)							Kesici Uç Insert Wendeschneidplatte	Yedek Parçaları / Spare Parts / Ersatzteile	
		DC	DCON	DCSFMS	OAL	LU	LPR	LS		Sıkma Vidası Screw Schraube	Tork Anahtar Torx Key Torx-Schlüssel
ATUM 12.5XD2 SP.. 050204	●	12.5	20	25	96	24	46	50	SP.. 050204	3006-M2x4	80-T06
ATUM 13XD2 SP.. 050204	●	13	20	25	98	26	48	50			
ATUM 13.5XD2 SP.. 050204	●	13.5	20	25	98	26	48	50			
ATUM 14XD2 SP.. 050204	●	14	20	25	100	28	50	50			
ATUM 14.5XD2 SP.. 050204	●	14.5	20	25	100	28	50	50			
ATUM 15XD2 SP.. 050204	●	15	20	25	102	30	52	50			
ATUM 15.5XD2 SP.. 060204	●	15.5	20	25	102	30	52	50	SP.. 060204	3007-M2.2x5	80-T07
ATUM 16XD2 SP.. 060204	●	16	25	34	110	32	54	56			
ATUM 16.5XD2 SP.. 060204	●	16.5	25	34	110	32	54	56			
ATUM 17XD2 SP.. 060204	●	17	25	34	112	34	56	56			
ATUM 17.5XD2 SP.. 060204	●	17.5	25	34	112	34	56	56			
ATUM 18XD2 SP.. 060204	●	18	25	34	114	36	58	56			
ATUM 18.5XD2 SP.. 060204	●	18.5	25	34	114	36	58	56			
ATUM 19XD2 SP.. 060204	●	19	25	34	116	38	60	56			
ATUM 19.5XD2 SP.. 060204	●	19.5	25	34	116	38	60	56			
ATUM 20XD2 SP.. 060204	●	20	25	34	118	40	62	56			
ATUM 20.5XD2 SP.. 060204	●	20.5	25	34	118	40	62	56			
ATUM 21XD2 SP.. 060204	●	21	25	34	120	42	64	56			
ATUM 21.5XD2 SP.. 060204	●	21.5	25	34	120	42	64	56			
ATUM 22XD2 SP.. 07T308	●	22	25	34	122	44	66	56			
ATUM 22.5XD2 SP.. 07T308	●	22.5	25	34	122	44	66	56			
ATUM 23XD2 SP.. 07T308	●	23	25	34	124	46	68	56			
ATUM 23.5XD2 SP.. 07T308	●	23.5	25	34	124	46	68	56			
ATUM 24XD2 SP.. 07T308	●	24	25	34	126	48	70	56			
ATUM 24.5XD2 SP.. 07T308	●	24.5	25	34	126	48	70	56			
ATUM 25XD2 SP.. 07T308	●	25	25	34	128	50	72	56			
ATUM 25.5XD2 SP.. 07T308	●	25.5	25	34	128	50	72	56			
ATUM 26XD2 SP.. 07T308	●	26	25	34	130	52	74	56			
ATUM 26.5XD2 SP.. 07T308	●	26.5	25	34	130	52	74	56			
ATUM 27XD2 SP.. 07T308	●	27	25	34	132	54	76	56			
ATUM 27.5XD2 SP.. 07T308	●	27.5	25	34	132	54	76	56			

R: Sağ / Right / Rechts L: Sol/Left/Links

● Stokta / In Stock / Auf Lager ○ Stokta Yok / Non Stock Item / Kein Lagerartikel, Lieferzeit auf Anfrage

TGTC Ucuna Uygundur. / Compatible with TGTC Insert. / Kompatibel mit TGTC Wendepalten.

Sipariş Örneği/Ordering Example/Bestellbeispiel

1 ad./pcs./stück ATUM 12.5xD2 SP.. 050204

Takma Uçlu Matkap Kullanım Kılavuzu : S 329 / User's Guide For U-Drills : P 329

S.330 / Bedienungsanleitung für Vollbohrer



Delme Derinliği
Drilling Depth
Bohrtiefe

= 2xÇap
= 2xDiameter
= 2xDurchmesser

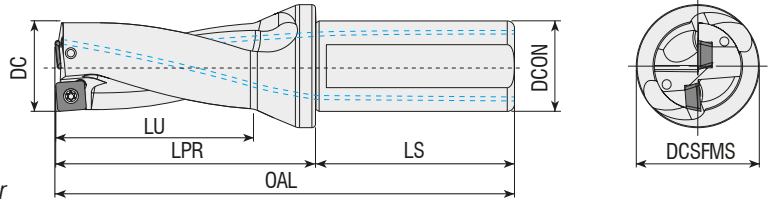

Takım Kodu
Ordering Code
Bestell-Bezeichnung

Stok
Stock
Lager

Takım Ölçüleri (mm)
Dimension (mm)
Abmessung (mm)

Kesici Uç
Insert
Wendeschneidplatte

Yedek Parçaları / Spare Parts / Ersatzteile

Sıkma Vidası
Screw
Schraube

Tork Anahtar
Torx Key
Torx-Schlüssel

DC DCON DCSFMS OAL LU LPR LS



ATUM 28XD2 SP. 090408	●	28	25	34	134	56	78	56	SP. 090408	4015-M3.5x9	80-T15
ATUM 28.5XD2 SP. 090408	●	28.5	25	34	134	56	78	56			
ATUM 29XD2 SP. 090408	●	29	25	34	136	58	80	56			
ATUM 29.5XD2 SP. 090408	●	29.5	25	34	136	58	80	56			
ATUM 30XD2 SP. 090408	●	30	32	44	147	60	87	60			
ATUM 31XD2 SP. 090408	●	31	32	44	149	62	89	60			
ATUM 32XD2 SP. 090408	●	32	32	44	151	64	91	60			
ATUM 33XD2 SP. 090408	●	33	32	44	153	66	93	60			
ATUM 34XD2 SP. 110408	●	34	32	44	155	68	95	60	SP. 110408	4015-M4x11	80-T15
ATUM 35XD2 SP. 110408	●	35	32	44	157	70	97	60			
ATUM 36XD2 SP. 110408	●	36	32	44	159	72	99	60			
ATUM 37XD2 SP. 110408	●	37	32	44	161	74	101	60			
ATUM 38XD2 SP. 110408	●	38	32	44	163	76	103	60			
ATUM 39XD2 SP. 110408	●	39	32	44	165	78	105	60			
ATUM 40XD2 SP. 110408	●	40	32	44	167	80	107	60			
ATUM 41XD2 SP. 110408	●	41	32	44	169	82	109	60			
ATUM 42XD2 SP. 140512	●	42	32	44	171	84	111	60	SP. 140512	1020-M5x11	80-T20
ATUM 43XD2 SP. 140512	●	43	32	44	173	86	113	60			
ATUM 44XD2 SP. 140512	●	44	32	44	175	88	115	60			
ATUM 45XD2 SP. 140512	●	45	40	54	192	90	122	70			
ATUM 46XD2 SP. 140512	●	46	40	54	194	92	124	70			
ATUM 47XD2 SP. 140512	●	47	40	54	196	94	126	70			
ATUM 48XD2 SP. 140512	●	48	40	54	198	96	128	70			
ATUM 49XD2 SP. 140512	●	49	40	54	200	98	130	70			
ATUM 50XD2 SP. 140512	●	50	40	54	202	100	132	70			

R: Sağ / Right / Rechts L: Sol/Left/Links

● Stokta / In Stock / Auf Lager ○ Stokta Yok / Non Stock Item / Kein Lagerartikel, Lieferzeit auf Anfrage
TGTC Ucuna Uygundur. / Compatible with TGTC Insert. / Kompatibel mit TGTC Wendeplatten.

Sipariş Örneği/Ordering Example/Bestellbeispiel

1 ad./pcs./stück ATUM 28xD2 SP. 090408

Takma Uçlu Matkap Kullanım Kılavuzu : S 329 / User's Guide For U-Drills : P 329

S.330 / Bedienungsanleitung für Vollbohrer



Delme Derinliği
Drilling Depth
Bohrtiefe

= 3xÇap
= 3xDiameter
= 3xDurchmesser

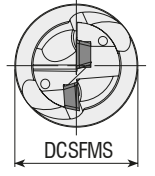
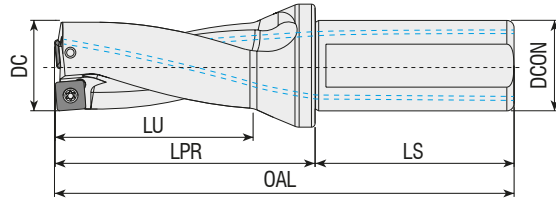

Takım Kodu Ordering Code Bestell-Bezeichnung	Stok Stock Lager	Takım Ölçüleri (mm) Dimension (mm) Abmessung (mm)							Kesici Uç Insert Wendeschneidplatte	Yedek Parçaları / Spare Parts / Ersatzteile	
		DC	DCON	DCSEMS	OAL	LU	LPR	LS		Sıkma Vidası Screw Schraube	Tork Anahtar Torx Key Torx-Schlüssel
ATUM 12.5XD3 SP. 050204	●	12.5	20	25	108	36	58	50	SP. 050204	3006-M2x4	80-T06
ATUM 13XD3 SP. 050204	●	13	20	25	111	39	61	50			
ATUM 13.5XD3 SP. 050204	●	13.5	20	25	111	39	61	50			
ATUM 14XD3 SP. 050204	●	14	20	25	114	42	64	50			
ATUM 14.5XD3 SP. 050204	●	14.5	20	25	114	42	64	50			
ATUM 15XD3 SP. 050204	●	15	20	25	117	45	67	50			
ATUM 15.5XD3 SP. 060204	●	15.5	20	25	117	45	67	50	SP. 060204	3007-M2.2x5	80-T07
ATUM 16XD3 SP. 060204	●	16	25	34	126	48	70	56			
ATUM 16.5XD3 SP. 060204	●	16.5	25	34	126	48	70	56			
ATUM 17XD3 SP. 060204	●	17	25	34	129	51	73	56			
ATUM 17.5XD3 SP. 060204	●	17.5	25	34	129	51	73	56			
ATUM 18XD3 SP. 060204	●	18	25	34	132	54	76	56			
ATUM 18.5XD3 SP. 060204	●	18.5	25	34	132	54	76	56			
ATUM 19XD3 SP. 060204	●	19	25	34	135	57	79	56			
ATUM 19.5XD3 SP. 060204	●	19.5	25	34	135	57	79	56			
ATUM 20XD3 SP. 060204	●	20	25	34	138	60	82	56			
ATUM 20.5XD3 SP. 060204	●	20.5	25	34	138	60	82	56			
ATUM 21XD3 SP. 060204	●	21	25	34	141	63	85	56			
ATUM 21.5XD3 SP. 060204	●	21.5	25	34	141	63	85	56			
ATUM 22XD3 SP. 07T308	●	22	25	34	144	66	88	56			
ATUM 22.5XD3 SP. 07T308	●	22.5	25	34	144	66	88	56			
ATUM 23XD3 SP. 07T308	●	23	25	34	147	69	91	56			
ATUM 23.5XD3 SP. 07T308	●	23.5	25	34	147	69	91	56			
ATUM 24XD3 SP. 07T308	●	24	25	34	150	72	94	56			
ATUM 24.5XD3 SP. 07T308	●	24.5	25	34	150	72	94	56			
ATUM 25XD3 SP. 07T308	●	25	25	34	153	75	97	56			
ATUM 25.5XD3 SP. 07T308	●	25.5	25	34	153	75	97	56			
ATUM 26XD3 SP. 07T308	●	26	25	34	156	78	100	56			
ATUM 26.5XD3 SP. 07T308	●	26.5	25	34	156	78	100	56			
ATUM 27XD3 SP. 07T308	●	27	25	34	159	81	103	56	SP. 090408	4015-M3.5x9	80-T15
ATUM 27.5XD3 SP. 07T308	●	27.5	25	34	159	81	103	56			
ATUM 28XD3 SP. 090408	●	28	25	34	162	84	106	56			
ATUM 28.5XD3 SP. 090408	●	28.5	25	34	162	84	106	56			
ATUM 29XD3 SP. 090408	●	29	25	34	165	87	109	56			
ATUM 29.5XD3 SP. 090408	●	29.5	25	34	165	87	109	56			
ATUM 30XD3 SP. 090408	●	30	32	44	177	90	117	60			
ATUM 30.5XD3 SP. 090408	●	30.5	32	44	177	90	117	60			
ATUM 31XD3 SP. 090408	●	31	32	44	180	93	120	60			
ATUM 31.5XD3 SP. 090408	●	31.5	32	44	180	93	120	60			
ATUM 32XD3 SP. 090408	●	32	32	44	183	96	123	60			
ATUM 32.5XD3 SP. 090408	●	32.5	32	44	183	96	123	60			
ATUM 33XD3 SP. 090408	●	33	32	44	186	99	126	60			
ATUM 33.5XD3 SP. 090408	●	33.5	32	44	186	99	126	60			

R: Sağ / Right / Rechts L: Sol/Left/Links

● Stokta / In Stock / Auf Lager ○ Stokta Yok / Non Stock Item / Kein Lagerartikel, Lieferzeit auf Anfrage
TGTC Ucuna Uygundur. / Compatible with TGTC Insert. / Kompatibel mit TGTC Wendeplatten.

Sipariş Örneği/Ordering Example/Bestellbeispiel

1 ad./pcs./stück ATUM 12.5xD3 SP. 050204

Takma Uçlu Matkap Kullanım Kılavuzu : S 329 / User's Guide For U-Drills : P 329

S.330 / Bedienungsanleitung für Vollbohrer



Delme Derinliği
Drilling Depth
Bohrtiefe

= 3xÇap
= 3xDiameter
= 3xDurchmesser

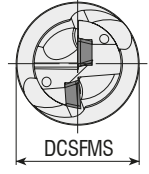
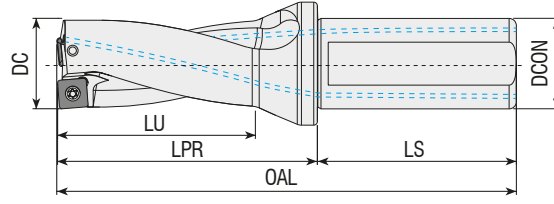

Takım Kodu Ordering Code Bestell-Bezeichnung	Stok Stock Lager	Takım Ölçüleri (mm) Dimension (mm) Abmessung (mm)							Kesici Uç Insert Wendeschneidplatte	Yedek Parçaları / Spare Parts / Ersatzteile		
		DC	DCON	DCSFMS	OAL	LU	LPR	LS		Sıkma Vidası Screw Schraube	Tork Anahtar Torx Key Torx-Schlüssel	
ATUM 34XD3 SP. 110408	●	34	32	44	189	102	129	60	SP. 110408	4015-M4x11	80-T15	
ATUM 34.5XD3 SP. 110408	●	34.5	32	44	189	102	129	60				
ATUM 35XD3 SP. 110408	●	35	32	44	192	105	132	60				
ATUM 35.5XD3 SP. 110408	●	35.5	32	44	192	105	132	60				
ATUM 36XD3 SP. 110408	●	36	32	44	195	108	135	60				
ATUM 36.5XD3 SP. 110408	●	36.5	32	44	195	108	135	60				
ATUM 37XD3 SP. 110408	●	37	32	44	198	111	138	60				
ATUM 37.5XD3 SP. 110408	●	37.5	32	44	198	111	138	60				
ATUM 38XD3 SP. 110408	●	38	32	44	201	114	141	60				
ATUM 38.5XD3 SP. 110408	●	38.5	32	44	201	114	141	60				
ATUM 39XD3 SP. 110408	●	39	32	44	204	117	144	60				
ATUM 39.5XD3 SP. 110408	●	39.5	32	44	204	117	144	60				
ATUM 40XD3 SP. 110408	●	40	32	44	207	120	147	60				
ATUM 40.5XD3 SP. 110408	●	40.5	32	44	207	120	147	60				
ATUM 41XD3 SP. 110408	●	41	32	44	210	123	150	60				
ATUM 41.5XD3 SP. 110408	●	41.5	32	44	210	123	150	60				
ATUM 42XD3 SP. 140512	●	42	32	44	213	126	153	60				SP. 140512
ATUM 42.5XD3 SP. 140512	●	42.5	32	44	213	126	153	60				
ATUM 43XD3 SP. 140512	●	43	32	44	216	129	156	60				
ATUM 43.5XD3 SP. 140512	●	43.5	32	44	216	129	156	60				
ATUM 44XD3 SP. 140512	●	44	32	44	219	132	159	60				
ATUM 44.5XD3 SP. 140512	●	44.5	32	44	219	132	159	60				
ATUM 45XD3 SP. 140512	●	45	40	54	237	135	167	70				
ATUM 45.5XD3 SP. 140512	●	45.5	40	54	237	135	167	70				
ATUM 46XD3 SP. 140512	●	46	40	54	240	138	170	70				
ATUM 47XD3 SP. 140512	●	47	40	54	243	141	173	70				
ATUM 48XD3 SP. 140512	●	48	40	54	246	144	176	70				
ATUM 49XD3 SP. 140512	●	49	40	54	249	147	179	70				
ATUM 50XD3 SP. 140512	●	50	40	54	252	150	182	70				
ATUM 51XD3 SP. 140512	●	51	40	54	255	153	185	70				
ATUM 52XD3 SP. 140512	●	52	40	54	258	156	188	70				

R: Sağ / Right / Rechts L: Sol/Left/Links
● Stokta / In Stock / Auf Lager ○ Stokta Yok / Non Stock Item / Kein Lagerartikel, Lieferzeit auf Anfrage
TGTC Ucuna Uygundur. / Compatiple with TGTC Insert. / Kompatibel mit TGTC Wendeplatten.

Sipariş Örneği/Ordering Example/Bestellbeispiel
1 ad./pcs./stück ATUM 34xD3 SP. 110408
Takma Uçlu Matkap Kullanım Kılavuzu : S 329 / User's Guide For U-Drills : P 329
S.330 / Bedienungsanleitung für Vollbohrer



Delme Derinliği
Drilling Depth
Bohrtiefe

= 4xÇap
= 4xDiameter
= 4xDurchmesser

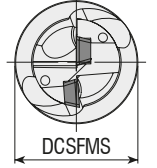
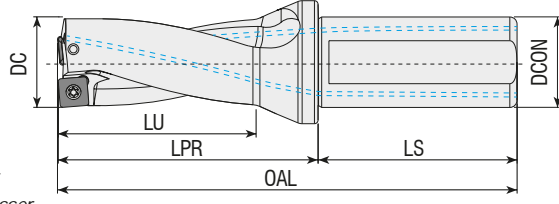

Takım Kodu Ordering Code Bestell-Bezeichnung	Stok Stock Lager	Takım Ölçüleri (mm) Dimension (mm) Abmessung (mm)							Kesici Uç Insert Wendeschneidplatte	Yedek Parçaları / Spare Parts / Ersatzteile		
		DC	DCON	DCSFMS	OAL	LU	LPR	LS		Sıkma Vidası Screw Schraube	Tork Anahtar Torx Key Torx-Schlüssel	
ATUM 13XD4 SP. 050204	●	13	20	25	124	52	74	50	SP. 050204	3006-M2x4	80-T06	
ATUM 14XD4 SP. 050204	●	14	20	25	128	56	78	50				
ATUM 15XD4 SP. 050204	●	15	20	25	132	60	82	50				
ATUM 16XD4 SP. 060204	●	16	25	34	142	64	86	56	SP. 060204	3007-M2.2x5	80-T07	
ATUM 17XD4 SP. 060204	●	17	25	34	146	68	90	56				
ATUM 17.5XD4 SP. 060204	●	17	25	34	146	68	90	56				
ATUM 18XD4 SP. 060204	●	18	25	34	150	72	94	56				
ATUM 19XD4 SP. 060204	●	19	25	34	154	76	98	56				
ATUM 19.5XD4 SP. 060204	●	19.5	25	34	154	76	98	56				
ATUM 20XD4 SP. 060204	●	20	25	34	158	80	102	56				
ATUM 21XD4 SP. 060204	●	21	25	34	162	84	106	56	SP. 07T308	3008-M2.5x6	80-T08	
ATUM 22XD4 SP. 07T308	●	22	25	34	166	88	110	56				
ATUM 23XD4 SP. 07T308	●	23	25	34	170	92	114	56				
ATUM 23.5XD4 SP. 07T308	●	23.5	25	34	170	92	114	56				
ATUM 24XD4 SP. 07T308	●	24	25	34	174	96	118	56				
ATUM 25XD4 SP. 07T308	●	25	25	34	178	100	122	56				
ATUM 26XD4 SP. 07T308	●	26	25	34	182	104	126	56				
ATUM 27XD4 SP. 07T308	●	27	25	34	186	108	130	56	SP. 090408	4015-M3.5x9	80-T15	
ATUM 27.5XD4 SP. 07T308	●	27.5	25	34	186	108	130	56				
ATUM 28XD4 SP. 090408	●	28	25	34	190	112	134	56				
ATUM 29XD4 SP. 090408	●	29	25	34	194	116	138	56				
ATUM 30XD4 SP. 090408	●	30	32	44	207	120	147	60				
ATUM 31XD4 SP. 090408	●	31	32	44	211	124	151	60				
ATUM 32XD4 SP. 090408	●	32	32	44	215	128	155	60				
ATUM 33XD4 SP. 090408	●	33	32	44	219	132	159	60	SP. 110408	4015-M4x11	80-T15	
ATUM 33.5XD4 SP. 090408	●	33.5	32	44	219	132	159	60				
ATUM 34XD4 SP. 110408	●	34	32	44	223	136	163	60				
ATUM 35XD4 SP. 110408	●	35	32	44	227	140	167	60				
ATUM 36XD4 SP. 110408	●	36	32	44	231	144	171	60				
ATUM 37XD4 SP. 110408	●	37	32	44	235	148	175	60				
ATUM 38XD4 SP. 110408	●	38	32	44	239	152	179	60				
ATUM 39XD4 SP. 110408	●	39	32	44	243	156	183	60	SP. 140512	1020-M5x11	80-T20	
ATUM 40XD4 SP. 110408	●	40	32	44	247	160	187	60				
ATUM 41XD4 SP. 110408	●	41	32	44	251	164	191	60				
ATUM 42XD4 SP. 140512	●	42	32	44	255	168	195	60				
ATUM 43XD4 SP. 140512	●	43	32	44	259	172	199	60				
ATUM 44XD4 SP. 140512	●	44	32	44	263	176	203	60				

R: Sağ / Right / Rechts L: Sol/Left/Links

● Stokta / In Stock / Auf Lager ○ Stokta Yok / Non Stock Item / Kein Lagerartikel, Lieferzeit auf Anfrage
TGTC Ucuna Uygundur. / Compatible with TGTC Insert. / Kompatibel mit TGTC Wendeplatten.



www.akkо.com.tr

Sipariş Örneği/Ordering Example/Bestellbeispiel

1 ad./pcs./stück ATUM 13xD4 SP. 050204

Takma Uçlu Matkap Kullanım Kılavuzu : S 329 / User's Guide For U-Drills : P 329

S.330 / Bedienungsanleitung für Vollbohrer



Delme Derinliği
Drilling Depth
Bohrtiefe

= 2xÇap
= 2xDiameter
= 2xDurchmesser

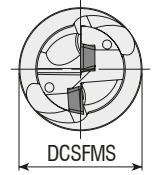
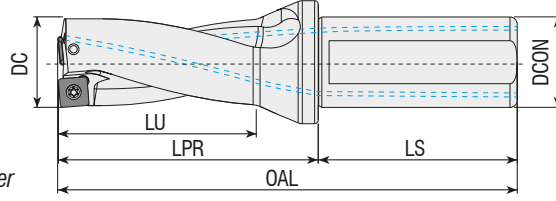

Takım Kodu
Ordering Code
Bestell-Bezeichnung

Stok
Stock
Lager

Takım Ölçüleri (mm)
Dimension (mm)
Abmessung (mm)

Kesici Uç
Insert
Wendeschneidplatte

Yedek Parçaları / Spare Parts / Ersatzteile

Sıkma Vidası
Screw
Schraube

Tork Anahtar
Torx Key
Torx-Schlüssel

DC

DCON

DCSFMS

OAL

LU

LPR

LS



ATUM 12.5XD2 SPGT 050204	●	12.5	20	25	96	24	46	50	SPGT 050204	3006-M2x4	80-T06
ATUM 13XD2 SPGT 050204	●	13	20	25	98	26	48	50			
ATUM 13.5XD2 SPGT 050204	●	13.5	20	25	98	26	48	50			
ATUM 14XD2 SPGT 050204	●	14	20	25	100	28	50	50			
ATUM 15XD2 SPGT 050204	●	15	20	25	102	30	52	50			
ATUM 16XD2 SPGT 060204	●	16	25	34	110	32	54	56	SPGT 060204	3007-M2.2x5	80-T07
ATUM 16.5XD2 SPGT 060204	●	16.5	25	34	110	32	54	56			
ATUM 17XD2 SPGT 060204	●	17	25	34	112	34	56	56			
ATUM 17.5XD2 SPGT 060204	●	17.5	25	34	112	34	56	56			
ATUM 18XD2 SPGT 060204	●	18	25	34	114	36	58	56			
ATUM 19XD2 SPGT 060204	●	19	25	34	116	38	60	56	SPGT 07T308	3008-M2.5x6	80-T08
ATUM 20XD2 SPGT 060204	●	20	25	34	118	40	62	56			
ATUM 22XD2 SPGT 07T308	●	22	25	34	122	44	66	56			
ATUM 22.5XD2 SPGT 07T308	●	22.5	25	34	122	44	66	56			
ATUM 23XD2 SPGT 07T308	●	23	25	34	124	46	68	56			
ATUM 24XD2 SPGT 07T308	●	24	25	34	126	48	70	56	SPGT 090408	4015-M3.5x9	80-T15
ATUM 25XD2 SPGT 07T308	●	25	25	34	128	50	72	56			
ATUM 26XD2 SPGT 07T308	●	26	25	34	130	52	74	56			
ATUM 28XD2 SPGT 090408	●	28	25	34	134	56	78	56			
ATUM 29XD2 SPGT 090408	●	29	25	34	136	58	80	56			
ATUM 30XD2 SPGT 090408	●	30	32	44	147	60	87	60	SPGT 110408	4015-M4x11	80-T15
ATUM 32XD2 SPGT 090408	●	32	32	44	151	64	91	60			
ATUM 35XD2 SPGT 110408	●	35	32	44	157	70	97	60			
ATUM 36XD2 SPGT 110408	●	36	32	44	159	72	99	60			
ATUM 40XD2 SPGT 110408	●	40	32	44	167	80	107	60			

R: Sağ / Right / Rechts L: Sol/Left/Links

● Stokta / In Stock / Auf Lager ○ Stokta Yok / Non Stock Item / Kein Lagerartikel, Lieferzeit auf Anfrage
ZCC Uçuna Uygundur. / Compatible with ZCC Insert. / Kompatibel mit ZCC Wendeplatten.

Sipariş Örneği/Ordering Example/Bestellbeispiel
1 ad./pcs./stück ATUM 12.5XD2 SPGT 050204

Takma Uçlu Matkap Kullanım Kılavuzu : S.329 / User's Guide For U-Drills : P.329
S.330 / Bedienungsanleitung für Vollbohrer





Delme Derinliği
Drilling Depth
Bohrtiefe

= 3xÇap
= 3xDiameter
= 3xDurchmesser

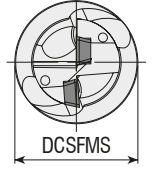
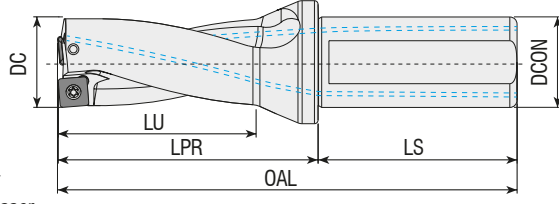

Takım Kodu Ordering Code Bestell-Bezeichnung	Stok Stock Lager	Takım Ölçüleri (mm) Dimension (mm) Abmessung (mm)							Kesici Uç Insert Wendeschneidplatte	Yedek Parçaları / Spare Parts / Ersatzteile	
		DC	DCON	DCSFMS	OAL	LU	LPR	LS		Sıkma Vidası Screw Schraube	Tork Anahtar Torx Key Torx-Schlüssel
ATUM 12.5XD3 SPGT 050204	●	12.5	20	25	108	36	58	50	SPGT 050204	3006-M2x4	80-T06
ATUM 13XD3 SPGT 050204	●	13	20	25	111	39	61	50			
ATUM 13.5XD3 SPGT 050204	●	13.5	20	25	111	39	61	50			
ATUM 14XD3 SPGT 050204	●	14	20	25	114	42	64	50			
ATUM 14.5XD3 SPGT 050204	●	14.5	20	25	114	42	64	50			
ATUM 15XD3 SPGT 050204	●	15	20	25	117	45	67	50			
ATUM 15.5XD3 SPGT 060204	●	15.5	20	25	117	45	67	50	SPGT 060204	3007-M2.2x5	80-T07
ATUM 16XD3 SPGT 060204	●	16	25	34	126	48	70	56			
ATUM 16.5XD3 SPGT 060204	●	16.5	25	34	126	48	70	56			
ATUM 17XD3 SPGT 060204	●	17	25	34	129	51	73	56			
ATUM 17.5XD3 SPGT 060204	●	17.5	25	34	129	51	73	56			
ATUM 18XD3 SPGT 060204	●	18	25	34	132	54	76	56			
ATUM 18.5XD3 SPGT 060204	●	18.5	25	34	132	54	76	56			
ATUM 19XD3 SPGT 060204	●	19	25	34	135	57	79	56			
ATUM 19.5XD3 SPGT 060204	●	19.5	25	34	135	57	79	56			
ATUM 20XD3 SPGT 060204	●	20	25	34	138	60	82	56			
ATUM 20.5XD3 SPGT 060204	●	20.5	25	34	138	60	82	56			
ATUM 21XD3 SPGT 060204	●	21	25	34	141	63	85	56			
ATUM 21.5XD3 SPGT 060204	●	21.5	25	34	141	63	85	56			
ATUM 22XD3 SPGT 07T308	●	22	25	34	144	66	88	56			
ATUM 22.5XD3 SPGT 07T308	●	22.5	25	34	144	66	88	56			
ATUM 23XD3 SPGT 07T308	●	23	25	34	147	69	91	56			
ATUM 23.5XD3 SPGT 07T308	●	23.5	25	34	147	69	91	56			
ATUM 24XD3 SPGT 07T308	●	24	25	34	150	72	94	56			
ATUM 24.5XD3 SPGT 07T308	●	24.5	25	34	150	72	94	56			
ATUM 25XD3 SPGT 07T308	●	25	25	34	153	75	97	56			
ATUM 25.5XD3 SPGT 07T308	●	25.5	25	34	153	75	97	56			
ATUM 26XD3 SPGT 07T308	●	26	25	34	156	78	100	56			
ATUM 26.5XD3 SPGT 07T308	●	26.5	25	34	156	78	100	56			
ATUM 27XD3 SPGT 07T308	●	27	25	34	159	81	103	56	SPGT 090408	4015-M3.5x9	80-T15
ATUM 27.5XD3 SPGT 07T308	●	27.5	25	34	159	81	103	56			
ATUM 28XD3 SPGT 090408	●	28	25	34	162	84	106	56			
ATUM 28.5XD3 SPGT 090408	●	28.5	25	34	162	84	106	56			
ATUM 29XD3 SPGT 090408	●	29	25	34	165	87	109	56			
ATUM 29.5XD3 SPGT 090408	●	29.5	25	34	165	87	109	56			
ATUM 30XD3 SPGT 090408	●	30	32	44	177	90	117	60			
ATUM 31XD3 SPGT 090408	●	31	32	44	180	93	120	60			
ATUM 32XD3 SPGT 090408	●	32	32	44	183	96	123	60			
ATUM 33XD3 SPGT 090408	●	33	32	44	186	99	126	60			

R: Sağ / Right / Rechts L: Sol/Left/Links
● Stokta / In Stock / Auf Lager ○ Stokta Yok / Non Stock Item / Kein Lagerartikel, Lieferzeit auf Anfrage
ZCC Ucuna Uygunudur. / Compatible with ZCC Insert. / Kompatibel mit ZCC Wendeschneidplatten.



Delme Derinliği
Drilling Depth
Bohrtiefe

= 3xÇap
= 3xDiameter
= 3xDurchmesser

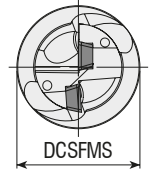
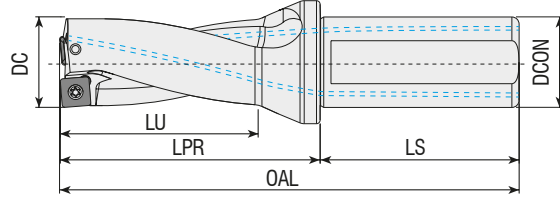

Takım Kodu Ordering Code Bestell-Bezeichnung	Stok Stock Lager	Takım Ölçüleri (mm) Dimension (mm) Abmessung (mm)							Kesici Uç Insert Wendeschneidplatte	Yedek Parçaları / Spare Parts / Ersatzteile	
		DC	DCON	DCSFMS	OAL	LU	LPR	LS		Sıkma Vidası Screw Schraube	Tork Anahtar Torx Key Torx-Schlüssel
ATUM 34XD3 SPGT 110408	●	34	32	44	189	102	129	60	SPGT 110408	4015-M4x11	80-T15
ATUM 35XD3 SPGT 110408	●	35	32	44	192	105	132	60			
ATUM 37XD3 SPGT 110408	●	37	32	44	198	111	138	60			
ATUM 38XD3 SPGT 110408	●	38	32	44	201	114	141	60			
ATUM 39XD3 SPGT 110408	●	39	32	44	204	117	144	60			
ATUM 40XD3 SPGT 110408	●	40	32	44	207	120	147	60	SPGT 140512	1020-M5x11	80-T20
ATUM 42XD3 SPGT 140512	●	42	32	44	213	126	153	60			
ATUM 43XD3 SPGT 140512	●	43	32	44	216	129	156	60			
ATUM 44XD3 SPGT 140512	●	44	32	44	219	132	159	60			
ATUM 49XD3 SPGT 140512	●	49	40	54	249	147	179	70			
ATUM 50XD3 SPGT 140512	●	50	40	54	252	150	182	70			

R: Sağ / Right / Rechts L: Sol/Left/Links

● Stokta / In Stock / Auf Lager ○ Stokta Yok / Non Stock Item / Kein Lagerartikel, Lieferzeit auf Anfrage
ZCC Ucuna Uygundur. / Compatible with ZCC Insert. / Kompatibel mit ZCC Wendeschneidplatten.

Sipariş Örneği/Ordering Example/Bestellbeispiel
1 ad./pcs./stück ATUM 34XD3 SPGT 110408

Takma Uçlu Matkap Kullanım Kılavuzu : S 329 / User's Guide For U-Drills : P 329
S.330 / Bedienungsanleitung für Vollbohrer





Delme Derinliği
Drilling Depth
Bohrtiefe

= 4xÇap
= 4xDiameter
= 4xDurchmesser

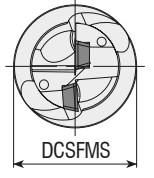
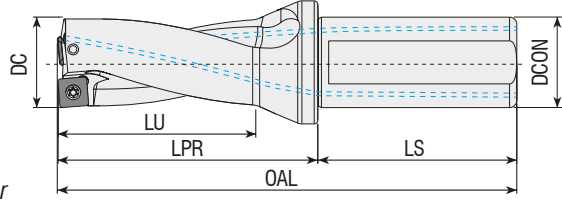

Takım Kodu Ordering Code Bestell-Bezeichnung	Stok Stock Lager	Takım Ölçüleri (mm) Dimension (mm) Abmessung (mm)							Kesici Uç Insert Wendeschneidplatte	Yedek Parçaları / Spare Parts / Ersatzteile	
		DC	DCON	DCSFMS	OAL	LU	LPR	LS		Sıkma Vidası Screw Schraube	Tork Anahtar Torx Key Torx-Schlüssel
ATUM 13XD4 SPGT 050204	●	13	20	25	124	52	74	50	SPGT 050204	3006-M2x4	80-T06
ATUM 14XD4 SPGT 050204	●	14	20	25	128	56	78	50			
ATUM 15XD4 SPGT 050204	●	15	20	25	132	60	82	50			
ATUM 16XD4 SPGT 060204	●	16	25	34	142	64	86	56			
ATUM 17XD4 SPGT 060204	●	17	25	34	146	68	90	56	SPGT 060204	3007-M2.2x5	80-T07
ATUM 17.5XD4 SPGT 060204	●	17.5	25	34	146	68	90	56			
ATUM 18XD4 SPGT 060204	●	18	25	34	150	72	94	56			
ATUM 19XD4 SPGT 060204	●	19	25	34	154	76	98	56			
ATUM 19.5XD4 SPGT 060204	●	19.5	25	34	154	76	98	56			
ATUM 20XD4 SPGT 060204	●	20	25	34	158	80	102	56			
ATUM 21XD4 SPGT 060204	●	21	25	34	162	84	106	56	SPGT 07T308	3008-M2.5x6	80-T08
ATUM 22XD4 SPGT 07T308	●	22	25	34	166	88	110	56			
ATUM 23XD4 SPGT 07T308	●	23	25	34	170	92	114	56			
ATUM 23.5XD4 SPGT 07T308	●	23.5	25	34	170	92	114	56			
ATUM 24XD4 SPGT 07T308	●	24	25	34	174	96	118	56			
ATUM 25XD4 SPGT 07T308	●	25	25	34	178	100	122	56			
ATUM 26XD4 SPGT 07T308	●	26	25	34	182	104	126	56	SPGT 090408	4015-M3.5x9	80-T15
ATUM 27.5XD4 SPGT 07T308	●	27.5	25	34	186	108	130	56			
ATUM 28XD4 SPGT 090408	●	28	25	34	190	112	134	56			
ATUM 29XD4 SPGT 090408	●	29	25	34	194	116	138	56			
ATUM 30XD4 SPGT 090408	●	30	32	44	207	120	147	60	SPGT 110408	4015-M4x11	80-T15
ATUM 33.5XD4 SPGT 090408	●	33.5	32	44	219	132	159	60			
ATUM 38XD4 SPGT 110408	●	38	32	44	239	152	179	60			

R: Sağ / Right / Rechts L: Sol/Left/Links

● Stokta / In Stock / Auf Lager ○ Stokta Yok / Non Stock Item / Kein Lagerartikel, Lieferzeit auf Anfrage
ZCC Ucuna Uygundur. / Compatible with ZCC Insert. / Kompatibel mit ZCC Wendeplatten.

Sipariş Örneği/Ordering Example/Bestellbeispiel

1 ad./pcs./stück ATUM 13XD4 SPGT 050204

Takma Uçlu Matkap Kullanım Kılavuzu : S 329 / User's Guide For U-Drills : P 329

S.330 / Bedienungsanleitung für Vollbohrer





Delme Derinliği
Drilling Depth
Bohrtiefe

= 3xÇap
= 3xDiameter
= 3xDurchmesser

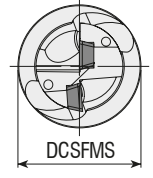
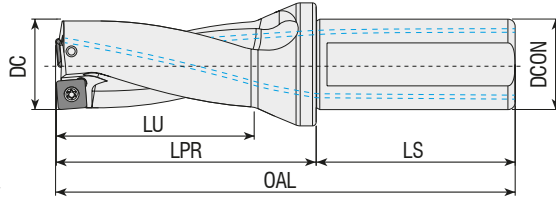

Takım Kodu Ordering Code Bestell-Bezeichnung	Stok Stock Lager	Takım Ölçüleri (mm) Dimension (mm) Abmessung (mm)							Kesici Uç Insert Wendeschneidplatte	Yedek Parçaları / Spare Parts / Ersatzteile				
		DC	DCON	DCSFMS	OAL	LU	LPR	LS		Sıkma Vidası Screw Schraube	Tork Anahtar Torx Key Torx-Schlüssel			
ATUM 14XD3 SO.. 050204	●	14	20	25	114	42	64	50	SO.. 050204	3006-M2x4	80-T06			
ATUM 15XD3 SO.. 050204	●	15	20	25	117	45	67	50						
ATUM 16XD3 SO.. 050204	●	16	25	34	126	48	70	56						
ATUM 16.5XD3 SO.. 050204	●	16.5	25	34	126	48	70	56						
ATUM 17XD3 SO.. 050204	●	17	25	34	129	51	73	56						
ATUM 17.5XD3 SO.. 050204	●	17.5	25	34	129	51	73	56	SO.. 060304	3007-M2.2x5	80-T07			
ATUM 18XD3 SO.. 060304	●	18	25	34	132	54	76	56						
ATUM 19XD3 SO.. 060204	●	19	25	34	135	57	79	56						
ATUM 20XD3 SO.. 060304	●	20	25	34	138	60	82	56						
ATUM 22XD3 SO.. 070305	●	22	25	34	144	66	88	56				SO.. 070305	3008-M2.5x6	80-T08
ATUM 22.5XD3 SO.. 070305	●	22.5	25	34	144	66	88	56						
ATUM 23XD3 SO.. 070305	●	23	25	34	147	69	91	56						
ATUM 24XD3 SO.. 070305	●	24	25	34	150	72	94	56						
ATUM 25XD3 SO.. 09T306	●	25	25	34	153	75	97	56	SO.. 09T306	4010-M3x8	80-T10			
ATUM 26XD3 SO.. 09T306	●	26	25	34	156	78	100	56						
ATUM 27XD3 SO.. 09T306	●	27	25	34	159	81	103	56						
ATUM 29XD3 SO.. 09T306	●	29	25	34	174	87	114	56						
ATUM 30XD3 SO.. 09T306	●	30	32	44	177	90	117	60						
ATUM 31XD3 SO.. 09T306	●	31	32	44	200	93	120	60						
ATUM 33XD3 SO.. 09T306	●	33	32	44	186	99	126	60						
ATUM 35XD3 SO.. 120408	●	35	32	44	192	105	132	60				SO..120408	4015-M4X11	80-T15
ATUM 36XD3 SO.. 120408	●	36	32	44	195	108	135	60						
ATUM 37XD3 SO.. 120408	●	37	32	44	198	111	138	60						
ATUM 38XD3 SO.. 120408	●	38	32	44	201	114	141	60						
ATUM 39XD3 SO.. 120408	●	39	32	44	204	117	144	60						
ATUM 40XD3 SO.. 120408	●	40	32	44	207	120	147	60						
ATUM 43XD3 SO.. 120408	●	43	32	44	216	129	156	60						

R: Sağ / Right / Rechts L: Sol/Left/Links

● Stokta / In Stock / Auf Lager ○ Stokta Yok / Non Stock Item / Kein Lagerartikel, Lieferzeit auf Anfrage
ISCR Ucuna Uygunudur. / Compatible with ISCR Insert. / Kompatibel mit ISCR Wendepplatten.

Sipariş Örneği/Ordering Example/Bestellbeispiel
1 ad./pcs./stück ATUM 14XD3 SO.. 050204

Takma Uçlu Matkap Kullanım Kılavuzu : S 329 / User's Guide For U-Drills : P 329
S.330 / Bedienungsanleitung für Vollbohrer



Delme Derinliği
Drilling Depth
Bohrtiefe

= 4xÇap
= 4xDiameter
= 4xDurchmesser

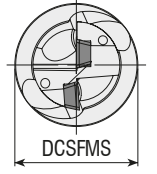
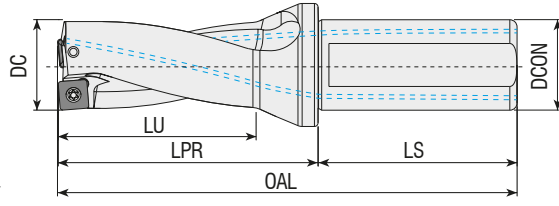

Takım Kodu Ordering Code Bestell-Bezeichnung	Stok Stock Lager	Takım Ölçüleri (mm) Dimension (mm) Abmessung (mm)							Kesici Uç Insert Wendeschneidplatte	Yedek Parçaları / Spare Parts / Ersatzteile	
		DC	DCON	DCSFMS	OAL	LU	LPR	LS		Sıkma Vidası Screw Schraube	Tork Anahtar Torx Key Torx-Schlüssel
ATUM 14XD4 SO.. 050204	●	14	20	25	128	56	78	50	SO.. 050204	3006-M2x4	80-T06
ATUM 14.5XD4 SO.. 050204	●	14.5	20	25	128	56	78	50			
ATUM 15XD4 SO.. 050204	●	15	20	25	132	60	62	50			
ATUM 15.5XD4 SO.. 050204	●	15.5	20	25	132	60	82	50			
ATUM 17XD4 SO.. 050204	●	17	25	34	146	68	90	56	SO.. 060304	3007-M2.2x5	80-T07
ATUM 19XD4 SO.. 060304	●	19	25	34	154	76	98	56			
ATUM 19.5XD4 SO.. 060304	●	19.5	25	34	154	76	98	56			
ATUM 20XD4 SO.. 060304	●	20	25	34	158	80	102	56			
ATUM 21XD4 SO.. 070305	●	21	25	34	162	84	106	56	SO.. 070305	3008-M2.5x6	80-T08
ATUM 22XD4 SO.. 070305	●	22	25	34	166	88	110	56			
ATUM 22.5XD4 SO.. 070305	●	22.5	25	34	166	88	110	56			
ATUM 23XD4 SO.. 070305	●	23	25	34	170	92	114	56			
ATUM 24XD4 SO.. 070305	●	24	25	34	174	96	118	56	SO.. 09T306	4010-M3x8	80-T10
ATUM 25XD4 SO.. 09T306	●	25	25	34	178	100	122	56			
ATUM 27XD4 SO.. 09T306	●	27	25	34	186	108	130	56			
ATUM 28XD4 SO.. 09T306	●	28	25	34	190	112	134	56			
ATUM 29XD4 SO.. 09T306	●	29	25	34	194	116	138	56	SO.. 120408	4015-M4X11	80-T15
ATUM 30XD4 SO.. 09T306	●	30	32	44	207	120	147	60			
ATUM 31XD4 SO.. 09T306	●	31	32	44	211	124	151	60			
ATUM 33XD4 SO.. 09T306	●	33	32	44	219	132	159	60			
ATUM 34XD4 SO.. 09T306	●	34	32	44	223	136	163	60	SO..120408	4015-M4X11	80-T15
ATUM 35XD4 SO.. 120408	●	35	32	44	227	140	167	60			

R: Sağ / Right / Rechts L: Sol/Left/Links

● Stokta / In Stock / Auf Lager ○ Stokta Yok / Non Stock Item / Kein Lagerartikel, Lieferzeit auf Anfrage
ISCR Ucuna Uygunudur. / Compatible with ISCR Insert. / Kompatibel mit ISCR Wendeplatten.

Sipariş Örneği/Ordering Example/Bestellbeispiel
1 ad./pcs./stück ATUM 14XD4 SO.. 050204

Takma Uçlu Matkap Kullanım Kılavuzu : S 329 / User's Guide For U-Drills : P 329
S.330 / Bedienungsanleitung für Vollbohrer



Delme Derinliği
Drilling Depth
Bohrtiefe

= 2xÇap
= 2xDiameter
= 2xDurchmesser

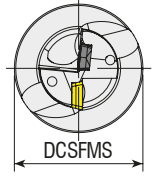
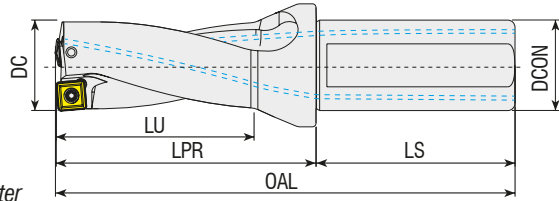

Takım Kodu Ordering Code Bestell-Bezeichnung	Stok Stock Lager	Takım Ölçüleri (mm) Dimension (mm) Abmessung (mm)								Kesici Uç Insert Wendeschneidplatte	Yedek Parçaları / Spare Parts / Ersatzteile	
		DC	DCON	DCSFMS	OAL	LU	LPR	LS	Sıkma Vidası Screw Schraube		Tork Anahtar Torx Key Torx-Schlüssel	
ATUM 14XD2 KDR 0502..	●	14	20	25	100	28	50	50	SPMT 050204-XOMT 050204	3006-M2x4	80-T06	
ATUM 18XD2 KDR 0602..	●	18	25	34	114	36	58	56	SPMT 060205-XOMT 060204	3007-M2.2x5	80-T07	
ATUM 20XD2 KDR 07T2..	●	20	25	34	118	40	62	56	SPMT 07T208 XOMT 07T205	3008-M2.5x6	80-T08	
ATUM 22XD2 KDR 07T2..	●	22	25	34	122	44	66	56				
ATUM 24XD2 KDR 0903..	●	24	25	34	126	48	70	56	SPMT 090308 XOMT 090305	3008-M3x7	80-T08	
ATUM 25XD2 KDR 0903..	●	25	25	34	128	50	72	56				
ATUM 26XD2 KDR 0903..	●	26	25	34	130	52	74	56	SPMT 11T308 XOMT 11T306	4015-M3.5x9	80-T15	
ATUM 28XD2 KDR 0903..	●	28	25	34	134	56	78	56				
ATUM 30XD2 KDR 11T3..	●	30	25	34	147	60	87	60	SPMT 130410 - XOMT 130406	4015-M4x11	80-T15	
ATUM 32XD2 KDR 11T3..	●	32	32	44	151	64	91	60				
ATUM 34XD2 KDR 11T3..	●	34	32	44	155	68	95	60				
ATUM 37XD2 KDR 1304..	●	37	32	44	161	74	101	60				

KRLY Ucuna Uygun. / Compatible with KRLY Insert. / Kompatibel mit KRLY Wendeplatten.



Delme Derinliği
Drilling Depth
Bohrtiefe

= 4xÇap
= 4xDiameter
= 4xDurchmesser

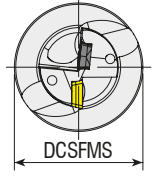
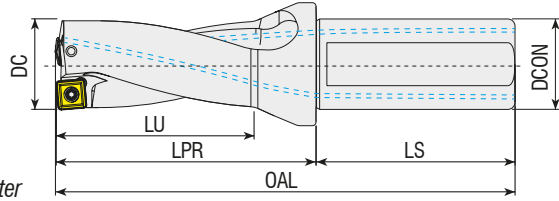

Takım Kodu Ordering Code Bestell-Bezeichnung	Stok Stock Lager	Takım Ölçüleri (mm) Dimension (mm) Abmessung (mm)								Kesici Uç Insert Wendeschneidplatte	Yedek Parçaları / Spare Parts / Ersatzteile	
		DC	DCON	DCSFMS	OAL	LU	LPR	LS	Sıkma Vidası Screw Schraube		Tork Anahtar Torx Key Torx-Schlüssel	
ATUM 14XD4 KDR 0502..	●	14	20	25	128	56	78	50	SPMT 050204 XOMT 050204	3006-M2x4	80-T06	
ATUM 14.5XD4 KDR 0502..	●	14.5	20	25	128	56	78	50				
ATUM 15XD4 KDR 0502..	●	15	20	25	132	60	82	50	SPMT 060205 XOMT 060204	3007-M2.2x5	80-T07	
ATUM 15.5XD4 KDR 0502..	●	15.5	20	25	132	60	82	50				
ATUM 16XD4 KDR 0502..	●	16	25	34	142	64	86	56	SPMT 07T208 XOMT 07T205	3008-M2.5x6	80-T08	
ATUM 17XD4 KDR 0602..	●	17	25	34	146	68	90	56				
ATUM 17.5XD4 KDR 0602..	●	17.5	25	34	146	68	90	56	SPMT 090308 XOMT 090305	3008-M3x7	80-T08	
ATUM 18XD4 KDR 0602..	●	18	25	34	150	72	94	56				
ATUM 18.5XD4 KDR 0602..	●	18.5	25	34	150	72	94	56	SPMT 07T208 XOMT 07T205	3008-M2.5x6	80-T08	
ATUM 19XD4 KDR 0602..	●	19	25	34	154	76	98	56				
ATUM 20XD4 KDR 07T2..	●	20	25	34	158	80	102	56	SPMT 090308 XOMT 090305	3008-M3x7	80-T08	
ATUM 21XD4 KDR 07T2..	●	21	25	34	162	84	106	56				
ATUM 22XD4 KDR 07T2..	●	22	25	34	166	88	110	56				
ATUM 24XD4 KDR 0903..	●	24	25	34	174	96	118	56				
ATUM 25XD4 KDR 0903..	●	25	25	34	178	100	122	56				

R: Sağ / Right / Rechts L: Sol/Left/Links

● Stokta / In Stock / Auf Lager ○ Stokta Yok / Non Stock Item / Kein Lagerartikel, Lieferzeit auf Anfrage

KRLY Ucuna Uygun. / Compatible with KRLY Insert. / Kompatibel mit KRLY Wendeplatten.

Takma Uçlu Matkap Kullanım Kılavuzu : S 329 / User's Guide For U-Drills : P 329 / S.330 / Bedienungsanleitung für Vollbohrer

Sipariş Örneği/Ordering Example/Bestellbeispiel
1 ad./pcs./stück ATUM 14XD2 KDR 0502..



Delme Derinliği
Drilling Depth
Bohrtiefe
= 3xÇap
= 3xDiameter
= 3xDurchmesser

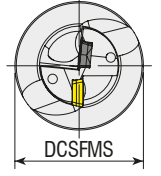
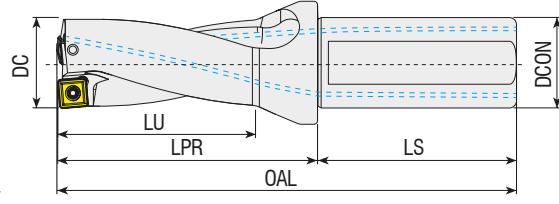

Takım Kodu Ordering Code Bestell-Bezeichnung	Stok Stock Lager	Takım Ölçüleri (mm) Dimension (mm) Abmessung (mm)								Kesici Uç Insert Wendeschneidplatte	Yedek Parçaları / Spare Parts / Ersatzteile		
		DC	DCON	DCSFMS	OAL	LU	LPR	LS	Sıkma Vidası Screw Schraube		Tork Anahtar Torx Key Torx-Schlüssel		
ATUM 12.5XD3 KDR 0402..	●	12.5	20	25	108	36	58	50	SPMT 040204 XOMT 040204		3006-M2x4	80-T06	
ATUM 13XD3 KDR 0402..	●	13	20	25	111	39	61	50					
ATUM 14XD3 KDR 0502..	●	14	20	25	114	42	64	50	SPMT 050204 XOMT 050204		3006-M2x4	80-T06	
ATUM 14.5XD3 KDR 0502..	●	14.5	20	25	114	42	64	50					
ATUM 15XD3 KDR 0502..	●	15	20	25	117	45	67	50	SPMT 060205 XOMT 060204		3007-M2.2x5	80-T07	
ATUM 15.5XD3 KDR 0502..	●	15.5	20	25	117	45	67	50					
ATUM 16XD3 KDR 0502..	●	16	25	34	126	48	70	56	SPMT 060205 XOMT 060204		3007-M2.2x5	80-T07	
ATUM 16.5XD3 KDR 0602..	●	16.5	25	34	126	48	70	56					
ATUM 17XD3 KDR 0602..	●	17	25	34	129	51	73	56	SPMT 07T208 XOMT 07T205		3008-M2.5x6	80-T08	
ATUM 17.5XD3 KDR 0602..	●	17.5	25	34	129	51	73	56					
ATUM 18XD3 KDR 0602..	●	18	25	34	132	54	76	56	SPMT 090308 XOMT 090305		3008-M3x7	80-T08	
ATUM 18.5XD3 KDR 0602..	●	18.5	25	34	132	54	76	56					
ATUM 19XD3 KDR 0602..	●	19	25	34	135	57	79	56	SPMT 090308 XOMT 090305		3008-M3x7	80-T08	
ATUM 19.5XD3 KDR 0602..	●	19.5	25	34	135	57	79	56					
ATUM 20XD3 KDR 07T2..	●	20	25	34	138	60	82	56	SPMT 11T308 XOMT 11T306		4015-M3.5x9	80-T15	
ATUM 20.5XD3 KDR 07T2..	●	20.5	25	34	138	60	82	56					
ATUM 21XD3 KDR 07T2..	●	21	25	34	141	63	85	56	SPMT 11T308 XOMT 11T306		4015-M3.5x9	80-T15	
ATUM 21.5XD3 KDR 07T2..	●	21.5	25	34	141	63	85	56					
ATUM 22XD3 KDR 07T2..	●	22	25	34	144	66	88	56	SPMT 130410 XOMT 130406		4015-M4x11	80-T15	
ATUM 22.5XD3 KDR 07T2..	●	22.5	25	34	144	66	88	56					
ATUM 23XD3 KDR 07T2..	●	23	25	34	147	69	91	56	SPMT 130410 XOMT 130406		4015-M4x11	80-T15	
ATUM 23.5XD3 KDR 07T2..	●	23.5	25	34	147	69	91	56					
ATUM 24XD3 KDR 0903..	●	24	25	34	150	72	94	56	SPMT 130410 XOMT 130406		4015-M4x11	80-T15	
ATUM 24.5XD3 KDR 0903..	●	24.5	25	34	150	72	94	56					
ATUM 25XD3 KDR 0903..	●	25	25	34	153	75	97	56	SPMT 130410 XOMT 130406		4015-M4x11	80-T15	
ATUM 25.5XD3 KDR 0903..	●	25.5	25	34	153	75	97	56					
ATUM 26XD3 KDR 0903..	●	26	25	34	156	78	100	56	SPMT 130410 XOMT 130406		4015-M4x11	80-T15	
ATUM 26.5XD3 KDR 0903..	●	26.5	25	34	156	78	100	56					
ATUM 27XD3 KDR 0903..	●	27	25	34	159	81	103	56	SPMT 130410 XOMT 130406		4015-M4x11	80-T15	
ATUM 27.5XD3 KDR 0903..	●	27.5	25	34	159	81	103	56					
ATUM 28XD3 KDR 0903..	●	28	25	34	162	84	106	56	SPMT 130410 XOMT 130406		4015-M4x11	80-T15	
ATUM 28.5XD3 KDR 0903..	●	28.5	25	34	162	84	106	56					
ATUM 29XD3 KDR 0903..	●	29	25	34	165	87	109	56	SPMT 130410 XOMT 130406		4015-M4x11	80-T15	
ATUM 29.5XD3 KDR 0903..	●	29.5	25	34	165	87	109	56					
ATUM 30XD3 KDR 11T3..	●	30	32	44	177	90	117	60	SPMT 130410 XOMT 130406		4015-M4x11	80-T15	
ATUM 30.5XD3 KDR 11T3..	●	30.5	32	44	177	90	117	60					
ATUM 32XD3 KDR 11T3..	●	32	32	44	183	96	123	60	SPMT 130410 XOMT 130406		4015-M4x11	80-T15	
ATUM 32.5XD3 KDR 11T3..	●	32.5	32	44	183	96	123	60					
ATUM 33XD3 KDR 11T3..	●	33	32	44	186	99	126	60	SPMT 130410 XOMT 130406		4015-M4x11	80-T15	
ATUM 33.5XD3 KDR 11T3..	●	33.5	32	44	186	99	126	60					
ATUM 34XD3 KDR 11T3..	●	34	32	44	189	102	129	60	SPMT 130410 XOMT 130406		4015-M4x11	80-T15	
ATUM 34.5XD3 KDR 11T3..	●	34.5	32	44	189	102	129	60					
ATUM 35XD3 KDR 11T3..	●	35	32	44	192	105	132	60	SPMT 130410 XOMT 130406		4015-M4x11	80-T15	
ATUM 35.5XD3 KDR 11T3..	●	35.5	32	44	192	105	132	60					
ATUM 37XD3 KDR 1304..	●	37	32	44	198	111	138	60	SPMT 130410 XOMT 130406		4015-M4x11	80-T15	
ATUM 37.5XD3 KDR 1304..	●	37.5	32	44	198	111	138	60					
ATUM 38XD3 KDR 1304..	●	38	32	44	201	114	141	60	SPMT 130410 XOMT 130406		4015-M4x11	80-T15	
ATUM 38.5XD3 KDR 1304..	●	38.5	32	44	201	114	141	60					
ATUM 39XD3 KDR 1304..	●	39	32	44	204	117	144	60	SPMT 130410 XOMT 130406		4015-M4x11	80-T15	
ATUM 39.5XD3 KDR 1304..	●	39.5	32	44	204	117	144	60					
ATUM 40XD3 KDR 1304..	●	40	32	44	207	120	147	60	SPMT 130410 XOMT 130406		4015-M4x11	80-T15	
ATUM 40.5XD3 KDR 1304..	●	40.5	32	44	207	120	147	60					

R: Sağ / Right / Rechts L: Sol/Left/Links

● Stokta / In Stock / Auf Lager ○ Stokta Yok / Non Stock Item / Kein Lagerartikel, Lieferzeit auf Anfrage
KRLY Ucuna Uygunudur. / Compatible with KRLY Insert. / Kompatibel mit KRLY Wendepplatten.

Sipariş Örneği/Ordering Example/Bestellbeispiel

1 ad./pcs./stück ATUM 12.5XD3 KDR 0402..

Takma Uçlu Matkap Kullanım Kılavuzu : S 329 / User's Guide For U-Drills : P 329
S.330 / Bedienungsanleitung für Vollbohrer



Delme Derinliği
Drilling Depth
Bohrtiefe

= 2xÇap
= 2xDiameter
= 2xDurchmesser

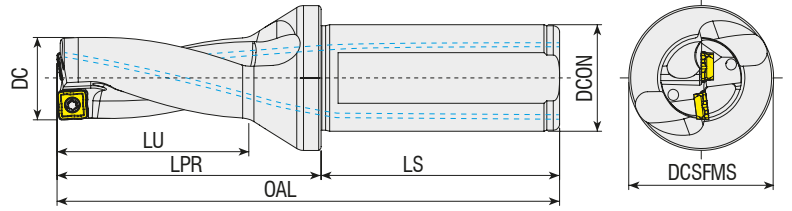

Takım Kodu Ordering Code Bestell-Bezeichnung	Stok Stock Lager	Takım Ölçüleri (mm) Dimension (mm) Abmessung (mm)							Kesici Uç Insert Wendeschneidplatte	Yedek Parçaları / Spare Parts / Ersatzteile	
		DC	DCON	DCSFMS	OAL	LU	LPR	LS		Sıkma Vidası Screw Schraube	Tork Anahtar Torx Key Torx-Schlüssel
ATUM 14XD2 SOMT 050204	●	14	20	25	100	28	50	50			
ATUM 16XD2 SOMT 050204	●	16	25	34	110	32	54	56	SOMT 050204	3006-M2x4	80-T06
ATUM 17XD2 SOMT 060204	●	17	25	34	112	34	56	56	SOMT 060204	3007-M2.2x5	80-T07
ATUM 18XD2 SOMT 060204	●	18	25	34	114	36	58	56	SOMT 070306		
ATUM 20XD2 SOMT 070306	●	20	25	34	118	40	62	56	SOMT 070306	3008-M2.5x6	80-T08
ATUM 22XD2 SOMT 070306	●	22	25	34	122	44	66	56	SOMT 08T306		
ATUM 24XD2 SOMT 08T306	●	24	25	34	126	48	70	56	SOMT 08T306	4015-M3.5x9	80-T15
ATUM 25XD2 SOMT 08T306	●	25	25	34	128	50	72	56	SOMT 09T308		
ATUM 26XD2 SOMT 08T306	●	26	25	34	130	52	74	56	SOMT 09T308	4015-M4x11	80-T20
ATUM 27XD2 SOMT 09T308	●	27	25	34	132	54	76	56	SOMT 11T308		
ATUM 28XD2 SOMT 09T308	●	28	25	34	134	56	78	56	SOMT 11T308	1020-M5x11	80-T20
ATUM 30XD2 SOMT 09T308	●	30	32	44	147	60	87	60	SOMT 130408		
ATUM 32XD2 SOMT 11T308	●	32	32	44	151	64	91	60	SOMT 130408	1020-M5x11	80-T20
ATUM 33XD2 SOMT 11T308	●	33	32	44	153	66	93	60	SOMT 150510		
ATUM 34XD2 SOMT 11T308	●	34	32	44	155	68	95	60	SOMT 150510		
ATUM 35XD2 SOMT 11T308	●	35	32	44	157	70	97	60			
ATUM 37XD2 SOMT 130408	●	37	32	44	161	74	101	60			
ATUM 38XD2 SOMT 130408	●	38	32	44	163	76	103	60			
ATUM 40XD2 SOMT 130408	●	40	32	44	167	80	107	60			
ATUM 45XD2 SOMT 150510	●	45	40	54	192	90	122	70			

R: Sağ / Right / Rechts L: Sol/Left/Links

● Stokta / In Stock / Auf Lager ○ Stokta Yok / Non Stock Item / Kein Lagerartikel, Lieferzeit auf Anfrage
TGTC Ucuna Uygunudur. / Compatible with TGTC Insert. / Kompatibel mit TGTC Wendeplatten.

Sipariş Örneği/Ordering Example/Bestellbeispiel
1 ad./pcs./stück ATUM 14XD2 SOMT 050204

Takma Uçlu Matkap Kullanım Kılavuzu : S 329 / User's Guide For U-Drills : P 329
S.330 / Bedienungsanleitung für Vollbohrer



Delme Derinliği
Drilling Depth
Bohrtiefe
= 3xÇap
= 3xDiameter
= 3xDurchmesser

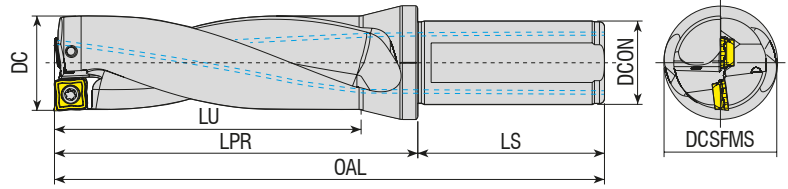

Takım Kodu Ordering Code Bestell-Bezeichnung	Stok Stock Lager	Takım Ölçüleri (mm) Dimension (mm) Abmessung (mm)							Kesici Uç Insert Wendeschneidplatte	Yedek Parçaları / Spare Parts / Ersatzteile	
		DC	DCON	DCSFMS	OAL	LU	LPR	LS		Sıkma Vidası Screw Schraube	Tork Anahtar Torx Key Torx-Schlüssel
ATUM 14XD3 SOMT 050204	●	14	20	25	114	42	64	50	SOMT 050204	3006-M2x4	80-T06
ATUM 14.5XD3 SOMT 050204	●	14.5	20	25	114	42	64	50			
ATUM 15XD3 SOMT 050204	●	15	20	25	117	45	67	50			
ATUM 15.5XD3 SOMT 050204	●	15.5	20	25	117	45	67	50			
ATUM 16XD3 SOMT 050204	●	16	25	34	126	48	70	56	SOMT 060204	3007-M2.2x5	80-T07
ATUM 16.5XD3 SOMT 060204	●	16.5	25	34	126	48	70	56			
ATUM 17XD3 SOMT 060204	●	17	25	34	129	51	73	56			
ATUM 17.5XD3 SOMT 060204	●	17.5	25	34	129	51	73	56			
ATUM 18XD3 SOMT 060204	●	18	25	34	132	54	76	56			
ATUM 18.5XD3 SOMT 060204	●	18.5	25	34	132	54	76	56			
ATUM 19XD3 SOMT 060204	●	19	25	34	135	57	79	56			
ATUM 19.5XD3 SOMT 070306	●	19.5	25	34	135	57	79	56			
ATUM 20XD3 SOMT 070306	●	20	25	34	138	60	82	56			
ATUM 20.5XD3 SOMT 070306	●	20.5	25	34	138	60	82	56			
ATUM 21XD3 SOMT 070306	●	21	25	34	141	63	85	56	SOMT 08T306	3008-M2.5x6	80-T08
ATUM 22XD3 SOMT 070306	●	22	25	34	144	66	88	56			
ATUM 22.5XD3 SOMT 08T306	●	22.5	25	34	144	66	88	56			
ATUM 23XD3 SOMT 08T306	●	23	25	34	147	69	91	56			
ATUM 23.5XD3 SOMT 08T306	●	23.5	25	34	147	69	91	56			
ATUM 24XD3 SOMT 08T306	●	24	25	34	150	72	94	56			
ATUM 24.5XD3 SOMT 08T306	●	24.5	25	34	150	72	94	56			
ATUM 25XD3 SOMT 08T306	●	25	25	34	153	75	97	56			
ATUM 26XD3 SOMT 08T306	●	26	25	34	156	78	100	56	SOMT 09T308	4015-M3.5x9	80-T15
ATUM 27XD3 SOMT 09T308	●	27	25	34	159	81	103	56			
ATUM 27.5XD3 SOMT 09T308	●	27.5	25	34	159	81	103	56			
ATUM 28XD3 SOMT 09T308	●	28	25	34	162	84	106	56			
ATUM 29XD3 SOMT 09T308	●	29	25	34	165	87	109	56			
ATUM 30XD3 SOMT 09T308	●	30	32	44	177	90	117	60			
ATUM 32XD3 SOMT 11T308	●	32	32	44	183	96	123	60			
ATUM 33XD3 SOMT 11T308	●	33	32	44	186	99	126	60			
ATUM 34XD3 SOMT 11T308	●	34	32	44	189	102	129	60			
ATUM 35XD3 SOMT 11T308	●	35	32	44	192	105	132	60			
ATUM 36XD3 SOMT 11T308	●	36	32	44	195	108	135	60	SOMT 130408	4015-M4x11	80-T20
ATUM 37XD3 SOMT 130408	●	37	32	44	198	111	138	60			
ATUM 38XD3 SOMT 130408	●	38	32	44	201	114	141	60			
ATUM 39XD3 SOMT 130408	●	39	32	44	204	117	144	60			
ATUM 40XD3 SOMT 130408	●	40	32	44	207	120	147	60	SOMT 150510	1020-M5x11	80-T20
ATUM 45XD3 SOMT 150510	●	45	40	54	237	135	167	70			
ATUM 49XD3 SOMT 150510	●	49	40	54	249	147	179	70	SOMT 150510	1020-M5x11	80-T20
ATUM 50XD3 SOMT 150510	●	50	40	54	252	150	182	70			

R: Sağ / Right / Rechts L: Sol/Left/Links

● Stokta / In Stock / Auf Lager ○ Stokta Yok / Non Stock Item / Kein Lagerartikel, Lieferzeit auf Anfrage

TGTC Ucuna Uygundur. / Compatiple with TGTC Insert. / Kompatibel mit TGTC Wendepplatten.



www.akkо.com.tr

Sipariş Örneği/Ordering Example/Bestellbeispiel

1 ad./pcs./stück ATUM 14XD3 SOMT 050204

Takma Uçlu Matkap Kullanım Kılavuzu : S 329 / User's Guide For U-Drills : P 329

S.330 / Bedienungsanleitung für Vollbohrer



Delme Derinliği
Drilling Depth
Bohrtiefe
= 4xÇap
= 4xDiameter
= 4xDurchmesser

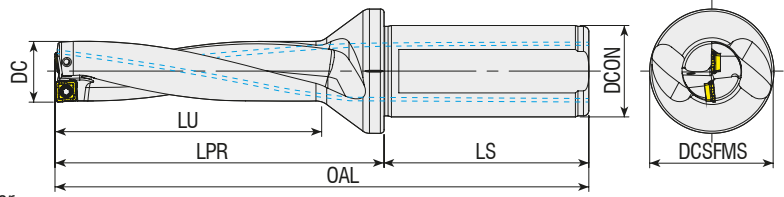

Takım Kodu
Ordering Code
Bestell-Bezeichnung

Stok
Stock
Lager

Takım Ölçüleri (mm)
Dimension (mm)
Abmessung (mm)

Kesici Uç
Insert
Wendeschneidplatte

Yedek Parçaları / Spare Parts / Ersatzteile

Sıkma Vidası
Screw
Schraube

Tork Anahtar
Torx Key
Torx-Schlüssel

Takım Kodu Ordering Code Bestell-Bezeichnung	Stok Stock Lager	Takım Ölçüleri (mm) Dimension (mm) Abmessung (mm)							Kesici Uç Insert Wendeschneidplatte	Sıkma Vidası Screw Schraube	Tork Anahtar Torx Key Torx-Schlüssel
		DC	DCON	DCSFMS	OAL	LU	LPR	LS			
ATUM 14XD4 SOMT 050204	●	14	20	25	128	56	78	50	SOMT 050204	3006-M2x4	80-T06
ATUM 14.5XD4 SOMT 050204	●	14.5	20	25	128	56	78	50			
ATUM 16XD4 SOMT 050204	●	16	25	34	142	64	86	56			
ATUM 17XD4 SOMT 060204	●	17	25	34	146	68	90	56	SOMT 060204	3007-M2.2x5	80-T07
ATUM 17.5XD4 SOMT 060204	●	17.5	25	34	146	68	90	56			
ATUM 18XD4 SOMT 060204	●	18	25	34	150	72	94	56			
ATUM 19XD4 SOMT 060204	●	19	25	34	154	76	98	56			
ATUM 20XD4 SOMT 070306	●	20	25	34	158	80	102	56	SOMT 070306	3008-M2.5x6	80-T08
ATUM 21XD4 SOMT 070306	●	21	25	34	162	84	106	56			
ATUM 22XD4 SOMT 070306	●	22	25	34	166	88	110	56	SOMT 08T306	3008-M2.5x6	80-T08
ATUM 24XD4 SOMT 08T306	●	24	25	34	174	96	118	56			
ATUM 25XD4 SOMT 08T306	●	25	25	34	178	100	122	56			

R: Sağ / Right / Rechts L: Sol/Left/Links

● Stokta / In Stock / Auf Lager ○ Stokta Yok / Non Stock Item / Kein Lagerartikel, Lieferzeit auf Anfrage
TGTC Uçuna Uygun / Compatible with TGTC Insert. / Kompatibel mit TGTC Wendeplatten.

Sipariş Örneği/Ordering Example/Bestellbeispiel

1 ad./pcs./stück ATUM ATUM 14XD4 SOMT 050204

Takma Uçlu Matkap Kullanım Kılavuzu : S 329 / User's Guide For U-Drills : P 329

S.330 / Bedienungsanleitung für Vollbohrer





Delme Derinliği
Drilling Depth
Bohrtiefe = 5xÇap
= 5xDiameter
= 5xDurchmesser

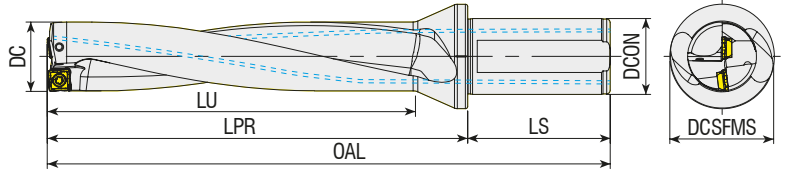

Takım Kodu Ordering Code Bestell-Bezeichnung	Stok Stock Lager	Takım Ölçüleri (mm) Dimension (mm) Abmessung (mm)							Kesici Uç Insert Wendeschneidplatte	Yedek Parçaları / Spare Parts / Ersatzteile	
		DC	DCON	DCSFMS	OAL	LU	LPR	LS		Sıkma Vidası Screw Schraube	Tork Anahtar Torx Key Torx-Schlüssel
ATUM 14XD5 SOMT 050204	●	14	20	25	142	70	92	50	SOMT 050204	3006-M2x4	80-T06
ATUM 15XD5 SOMT 050204	●	15	20	25	147	75	97	50			
ATUM 15.5XD5 SOMT 050204	●	15.5	20	25	147	75	97	50			
ATUM 16XD5 SOMT 050204	●	16	25	34	158	80	102	56	SOMT 060204	3007-M2.2x5	80-T07
ATUM 17.5XD5 SOMT 060204	●	17	25	34	163	85	107	56			
ATUM 18XD5 SOMT 060204	●	18	25	34	168	90	112	56			
ATUM 19XD5 SOMT 060204	●	19	25	34	173	95	117	56	SOMT 070306	4015-M3.5x9	80-T15
ATUM 19.5XD5 SOMT 070306	●	19	25	34	173	95	117	56			
ATUM 20XD5 SOMT 070306	●	20	25	34	178	100	122	56			
ATUM 21XD5 SOMT 070306	●	21	25	34	183	105	127	56	SOMT 08T306	3008-M2.5x6	80-T08
ATUM 22XD5 SOMT 070306	●	22	25	34	188	110	132	56			
ATUM 23XD5 SOMT 08T306	●	23	25	34	193	115	137	56			
ATUM 24XD5 SOMT 08T306	●	24	25	34	198	120	142	56	SOMT 09T308	4015-M3.5x9	80-T15
ATUM 25XD5 SOMT 08T306	●	25	25	34	203	125	147	56			
ATUM 26XD5 SOMT 08T306	●	26	25	34	208	130	152	56			
ATUM 27XD5 SOMT 09T308	●	27	25	34	213	135	157	56	SOMT 11T308	4015-M3.5x9	80-T15
ATUM 28XD5 SOMT 09T308	●	28	25	34	218	140	162	56			
ATUM 29XD5 SOMT 09T308	●	29	25	34	223	145	167	56			
ATUM 30XD5 SOMT 09T308	●	30	32	44	237	150	177	60	SOMT 11T308	4015-M3.5x9	80-T15
ATUM 33XD5 SOMT 11T308	●	33	32	44	252	165	192	60			
ATUM 34XD5 SOMT 11T308	●	34	32	44	257	170	197	60			
ATUM 35XD5 SOMT 11T308	●	35	32	44	262	175	202	60	SOMT 11T308	4015-M3.5x9	80-T15
ATUM 36XD5 SOMT 11T308	●	36	32	44	267	180	207	60			

R: Sağ / Right / Rechts L: Sol/Left/Links

● Stokta / In Stock / Auf Lager ○ Stokta Yok / Non Stock Item / Kein Lagerartikel, Lieferzeit auf Anfrage

TGTC Ucuna Uygunur. / Compatible with TGTC Insert. / Kompatibel mit TGTC Wendeplatten.

Sipariş Örneği/Ordering Example/Bestellbeispiel

1 ad./pcs./stück ATUM 13XD5 SOMT 050204

Takma Uçlu Matkap Kullanım Kılavuzu : S 329 / User's Guide For U-Drills : P 329

S.330 / Bedienungsanleitung für Vollbohrer



Delme Derinliği = 3xÇap
Drilling Depth = 3xDiameter
Bohrtiefe = 3xDurchmesser

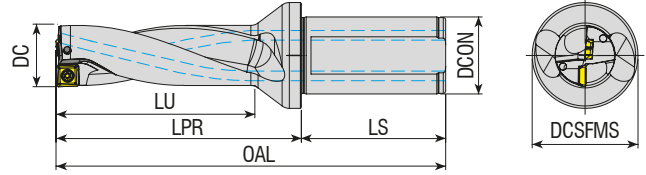

Takım Kodu Ordering Code Bestell-Bezeichnung	Stok Stock Lager	Takım Ölçüleri (mm) Dimension (mm) Abmessung (mm)									Kesici Uç Insert Wendeschneidplatte	Yedek Parçaları / Spare Parts / Ersatzteile		
		DC	DCON	DCSFMS	OAL	LU	LPR	LS	Sıkma Vidası Screw Schraube	Tork Anahtar Torx Key Torx-Schlüssel				
ATUM 14XD3 880-0202..	●	14	20	25	108	45	58	50	880-02...C / P		3006-M2x4	80-T06		
ATUM 14.5XD3 880-0202..	●	14.5	20	25	110	46	60	50						
ATUM 15XD3 880-0202..	●	15	20	25	112	48	62	50						
ATUM 15.5XD3 880-0202..	●	15.5	20	25	114	50	64	50						
ATUM 16XD3 880-0202..	●	16	20	25	116	51	66	50	880-03...C / P		3007-M2.2x5	80-T07		
ATUM 16.5XD3 880-0303..	●	16.5	20	25	118	53	68	50						
ATUM 17XD3 880-0303..	●	17	20	25	119	54	69	50						
ATUM 17.5XD3 880-0303..	●	17.5	25	32	128	56	72	56						
ATUM 18XD3 880-0303..	●	18	25	32	129	57	73	56	880-04...C / P		3008-M2.5x6	80-T08		
ATUM 18.5XD3 880-0303..	●	18.5	25	32	131	59	75	56						
ATUM 19XD3 880-0303..	●	19	25	32	132	60	76	56						
ATUM 19.5XD3 880-0303..	●	19.5	25	32	135	62	79	56						
ATUM 20XD3 880-0403..	●	20	25	32	137	64	81	56	880-05...C / P		4010-M3x8	80-T10		
ATUM 20.5XD3 880-0403..	●	20.5	25	32	138	65	82	56						
ATUM 21XD3 880-0403..	●	21	25	32	140	66	84	56						
ATUM 21.5XD3 880-0403..	●	21.5	25	32	142	68	86	56						
ATUM 22XD3 880-0403..	●	22	25	32	143	69	87	56	880-06...C / P		3010-M3.5x9	80-T10		
ATUM 22.5XD3 880-0403..	●	22.5	25	32	146	71	90	56						
ATUM 23XD3 880-0403..	●	23	25	32	147	72	91	56						
ATUM 24XD3 880-0503..	●	24	25	32	151	76	95	56						
ATUM 25XD3 880-0503..	●	25	25	32	155	79	99	56	880-07...C / P		3010-M3.5x9	80-T15		
ATUM 26XD3 880-0503..	●	26	32	44	162	81	102	60						
ATUM 27XD3 880-0503..	●	27	32	44	165	84	105	60						
ATUM 28XD3 880-0503..	●	28	32	44	169	87	109	60						
ATUM 29XD3 880-0503..	●	29	32	44	172	90	112	60	880-08...C / P		4015-M4x11	80-T15		
ATUM 30XD3 880-0604..	●	30	32	44	177	94	117	60						
ATUM 31XD3 880-0604..	●	31	40	54	191	97	121	70						
ATUM 32XD3 880-0604..	●	32	40	54	194	100	124	70						
ATUM 33XD3 880-0604..	●	33	40	54	198	103	128	70	880-08...C / P		4015-M4x11	80-T15		
ATUM 34XD3 880-0604..	●	34	40	54	201	106	131	70						
ATUM 35XD3 880-0604..	●	35	40	54	205	109	135	70						
ATUM 36XD3 880-0704..	●	36	40	54	209	112	139	70						
ATUM 38XD3 880-0704..	●	38	40	54	216	118	146	70	880-08...C / P		4015-M4x11	80-T15		
ATUM 39XD3 880-0704..	●	39	40	54	219	121	149	70						
ATUM 40XD3 880-0704..	●	40	40	54	223	124	153	70						
ATUM 41XD3 880-0704..	●	41	40	54	227	127	157	70						
ATUM 42XD3 880-0704..	●	42	40	54	230	130	160	70	880-08...C / P		4015-M4x11	80-T15		
ATUM 45XD3 880-0805..	●	45	40	54	242	140	172	70						
ATUM 46XD3 880-0805..	●	46	40	54	246	143	176	70						
ATUM 48XD3 880-0805..	●	48	40	54	253	149	183	70						
ATUM 50XD3 880-0805..	●	50	40	54	260	155	190	70						

R: Sağ / Right / Rechts L: Sol/Left/Links

● Stokta / In Stock / Auf Lager ○ Stokta Yok / Non Stock Item / Kein Lagerartikel, Lieferzeit auf Anfrage
SNDVK Ucuna Uygunudur. / Compatiple with SNDVK Insert. / Kompatibel mit SNDVK Wendeplatten.

Sipariş Örneği/Ordering Example/Bestellbeispiel

1 ad./pcs./stück ATUM 14XD3 880-0202..

Takma Uçlu Matkap Kullanım Kılavuzu : S 329 / User's Guide For U-Drills : P 329

S.330 / Bedienungsanleitung für Vollbohrer

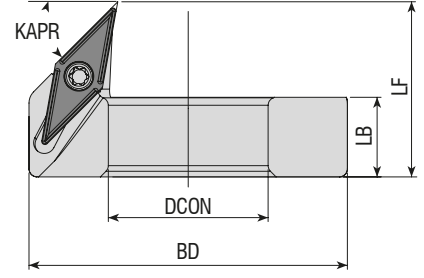

Takım Kodu
Ordering Code
Bestell-Bezeichnung

Stok
Stock
Lager

Takım Ölçüleri (mm)
Dimension (mm)
Abmessung (mm)

Kullanılacak
ATUM Ölçüsü
Compatible
ATUM Diameter
Verwendeter Vollbohrer

Yedek Parçaları / Spare Parts / Ersatzteile

Kesici Uç
Insert
Wendeschneidplatte

Sıkma Vidası
Screw
Schraube

Tork Anahtar
Torx Key
Torx-Schlüssel

Montaj Vidası
Mounting Screw
Befestigungsschraube

Montaj Vida Anahtar
Mounting Screw Key
Befestigungsschraube

DB DCON LB LF ATUM Ø



ADCR-120-VB1103	●	32	12	10	22	12.5
ADCR-125-VB1103	●	32.5	12.5	10	22	13
ADCR-130-VB1103	●	33	13	10	22	13.5
ADCR-135-VB1103	●	33.5	13.5	10	22	14
ADCR-140-VB1103	●	34	14	10	22	14.5
ADCR-145-VB1103	●	34.5	14.5	10	22	15
ADCR-150-VB1103	●	35	15	10	22	15.5 -16
ADCR-155-VB1103	●	35.5	15.5	10	22	16.5
ADCR-160-VB1103	●	36	16	10	22	17
ADCR-165-VB1103	●	36.5	16.5	10	22	17.5
ADCR-170-VB1103	●	37	17	10	22	18
ADCR-175-VB1103	●	37.5	17.5	10	22	18.5
ADCR-180-VB1103	●	38	18	10	22	19
ADCR-185-VB1103	●	38.5	18.5	10	22	19.5
ADCR-190-VB1103	●	39	19	10	22	20
ADCR-195-VB1103	●	39.5	19.5	10	22	20.5
ADCR-200-VB1103	●	40	20	10	22	21
ADCR-205-VB1103	●	40.5	20.5	10	22	21.5
ADCR-210-VB1103	●	41	21	10	22	22
ADCR-215-VB1103	●	41.5	21.5	10	22	22.5
ADCR-220-VB1103	●	42	22	10	22	23
ADCR-225-VB1103	●	42.5	22.5	10	22	23.5
ADCR-230-VB1103	●	43	23	10	22	24
ADCR-235-VB1103	●	43.5	23.5	10	22	24.5
ADCR-240-VB1103	●	44	24	10	22	25
ADCR-245-VB1103	●	44.5	24.5	10	22	25.5
ADCR-250-VB1103	●	45	25	10	22	26
ADCR-255-VB1103	●	45.5	25.5	10	22	26.5
ADCR-260-VB1103	●	46	26	10	22	27
ADCR-265-VB1103	●	46.5	26.5	10	22	27.5
ADCR-270-VB1103	●	47	27	10	22	28
ADCR-275-VB1103	●	47.5	27.5	10	22	28.5
ADCR-280-VB1103	●	48	28	10	22	29
ADCR-285-VB1103	●	48.5	28.5	10	22	29.5
ADCR-290-VB1103	●	49	29	10	22	30
ADCR-295-VB1103	●	49.5	29.5	10	22	30.5
ADCR-300-VB1103	●	50	30	10	22	31

VBM. 1103..

4008-M2.5x6

80-T08

AAV-14-M5x14

AAL-03-3

R: Sağ / Right / Rechts L: Sol/Left/ Links

● Stokta / In Stock / Auf Lager ○ Stokta Yok / Non Stock Item / Kein Lagerartikel, Lieferzeit auf Anfrage

Sipariş Örneği/Ordering Example/Bestellbeispiel

1 ad./pcs./stück ADCR-120-VB1103

Takma Uçlu Matkap Kullanım Kılavuzu : S 329 / User's Guide For U-Drills : P 329

S.330 / Bedienungsanleitung für Vollbohrer



Tavsiye Edilen / Recommended / Empfehlung

A

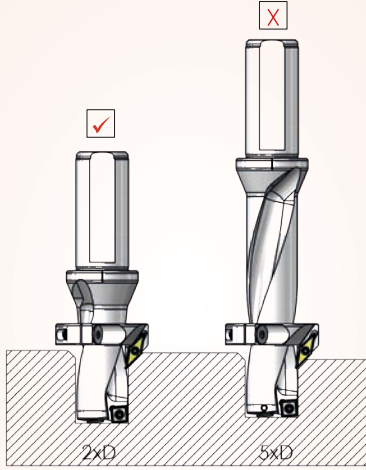

Mümkünse, her zaman kısa bir delme takımı kullanın. Değilse, titreşimi en aza indirmek için kesme hızını azaltın.
If possible, use it always short drilling tools. Otherwise, reduce your speeds to minimize vibration.
Bitte möglichst kurze Bohrwerkzeuge verwenden. Sollte dies nicht möglich sein, reduzieren Sie bitte die Geschwindigkeit, um Vibrationen zu vermeiden.

B

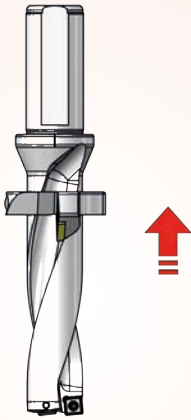

Mümkün olduğunca pah kırma halkasını shaft kısmına yakın montaj yap.
Get close to the mounting shaft of the chamfering ring as possible.
Befestigen Sie den Fasing möglichst nah am Schaft.

C

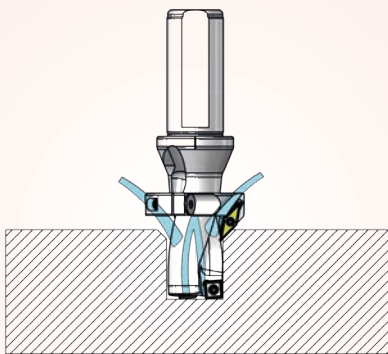

Daha iyi uç ömrü için harici soğutucu ve matkap ucu iç soğutucu uygulamak.
Apply external cooling and internal coolant drill for a better life for inserts.
Setzen Sie innere und äußere Kühlung ein, um die Standzeit der Wendepaltten zu erhöhen.

Montaj Şekli / Mounting System / Montage-Hinweise

1

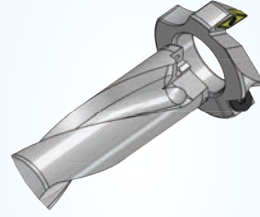

Matkap gövdesi üzerine pah kırma halkasını takın.
Put the chamfering ring to drill body.
Schieben Sie den Fasing auf den Bohrkörper.

2

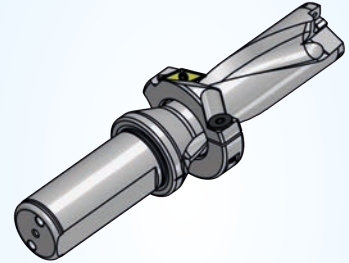

İstenilen konuma pah kırma halkasını kaydırın.
Please slide chamfering ring to the desired position.
Befestigen Sie den Fasing an der gewünschten Position.

3

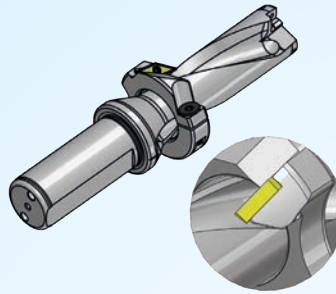

Pah kırma halkasını talaş akışına mani olmayacak şekilde helis başlangıcına denk getirin.
Please keep chamfering ring position which will not resist to fluiding chips and try to be equal to the helix start points.
Positionieren Sie den Fasing bündig mit der Bohrspirale um einen problemlosen Späne-transport zu gewährleisten.

4

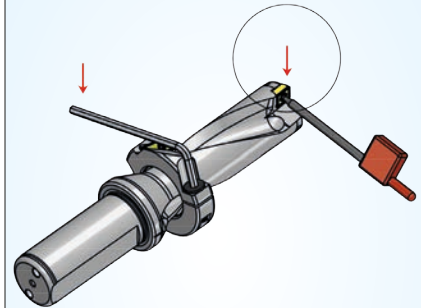

Pah kırma halkasını sıkın ve matkabin uçlarını takın.
Tightening the chamfering ring and put the drill insert.
Den Fasing festziehen und die Bohr-Wendepaltten einbauen.

Pah kırma halkasının doğru montaj şekli.
Proper installation of chamfering rings.
Korrekte Montage des Fasrings.

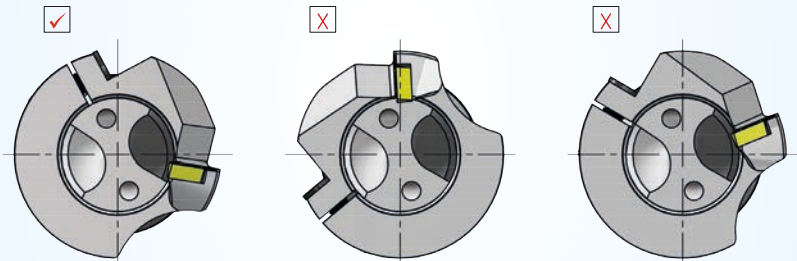

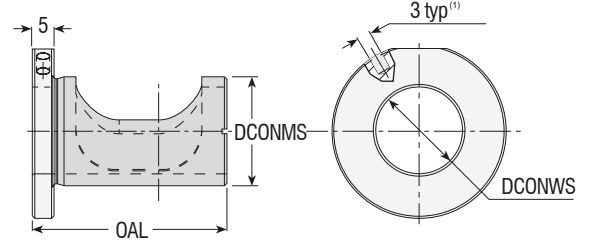

Takım Kodu Ordering Code Bestell-Bezeichnung	Stok Stock Lager	Takım Ölçüleri (mm) Dimension (mm) Abmessung (mm)		
		DCON	BD	LF
AET-2025	●	20	25	44
AET-2532	●	25	32	46
AET-3240	●	32	40	55

■ (1) Delik ince bir metal yardımıyla adaptörün radyal olarak ayarlanmasını kolaylaştırmak için kullanılır. / Holes for inserting a pin, used to facilitate radial adjustment of the sleeve (pin not supplied).
Bohrung zum Einsetzen eines Stiftes mit dem der Adapter radial eingestellt werden kann (Stift ist nicht im Lieferumfang enthalten).

Frezeleme tezgahında takma uçlu matkabın nominal çapı, matkabın ekseninin, spindle eksenine göre ötelenmesiyle değiştirilebilir.
On a milling machine the drill's nominal diameter can be changed by shifting the drill's axis out of the tool spindle.

Auf einer Fräsmaschine kann die Nennweite des Bohrers durch Verschieben der Bohrerachse aus der Spindelachse verändert werden.

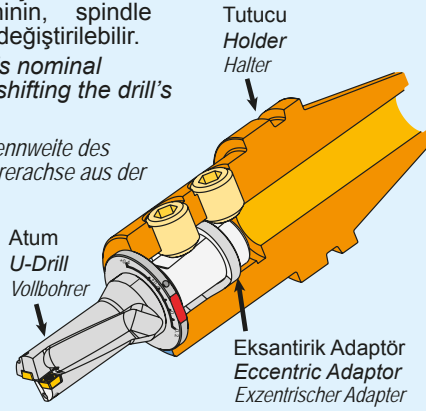
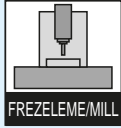

Radyal ayarlama pimi. (Verilmeyecektir.)
Radial adjustment pin. (not supplied)
Radial - Einstellstift (nicht im Lieferumfang)

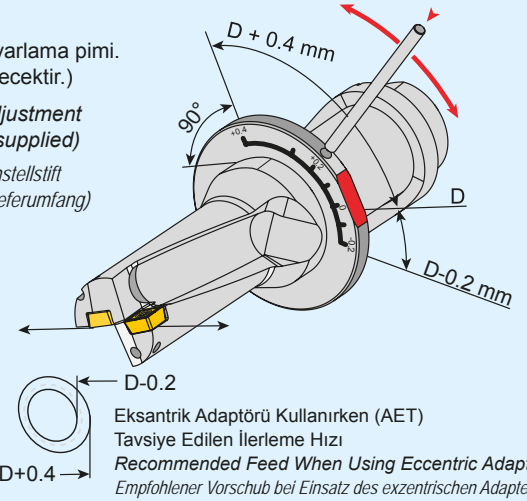

D-0.2
Eksantrik Adaptörü Kullanırken (AET)
Tavsiye Edilen İlerleme Hızı
Recommended Feed When Using Eccentric Adaptor
Empfohlener Vorschub bei Einsatz des exzentrischen Adapters

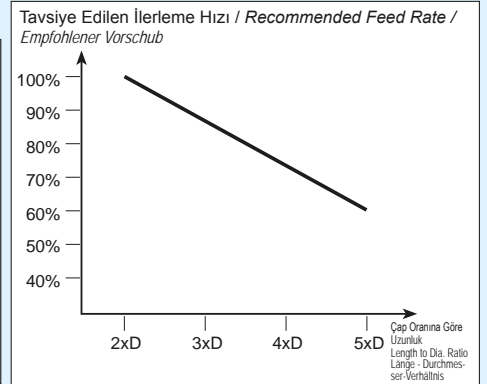
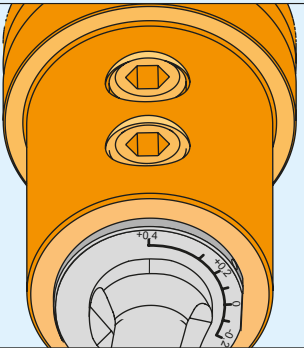
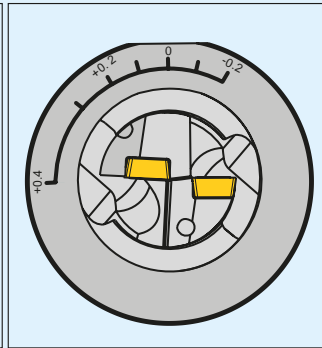
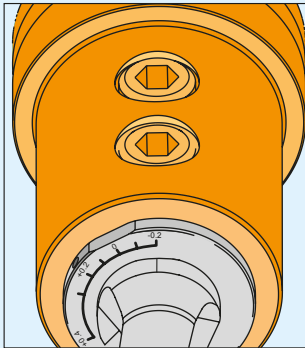

Delik Çapı
24.8 mm
Hole Diameter
Lochdurchmesser

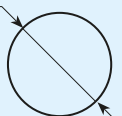

U-Drill Çapı = 25 mm
Drill Diameter = 25 mm
Vollbohrer Durchmesser = 25mm

Delik Çapı
25 mm
Hole Diameter
Lochdurchmesser

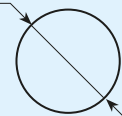

U-Drill Çapı = 25 mm
Drill Diameter = 25 mm
Vollbohrer Durchmesser = 25mm

Delik Çapı
25.4 mm
Hole Diameter
Lochdurchmesser

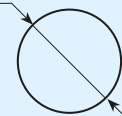

U-Drill Çapı = 25 mm
Drill Diameter = 25 mm
Vollbohrer Durchmesser = 25mm

ATUM'un üzerindeki düz çizgi adaptörün sıfır rakamının üzerine konulmalıdır. AET'nin (eksantrik adaptörün) çevrilmesini kolaylaştırmak için AET'nin üzerindeki deliğe, metal bir çubuk ya da vida anahtarları yerleştirilebilir. AET'yi ayarlama öncesi tutucunun vidasını hafifçe çözün.

The adjustment markings should be located perpendicular to the flat on the circumference of the U-DRILL flange.
To facilitate the rotation of the adaptor, a metal rod or a screw key may be inserted into a hole on the eccentric adaptor flange. Unlock adaptor screw before adjusting adaptor.

Die Einstellmarkierung sollte senkrecht zur Fläche des Bohrerschaftes stehen. Zum Drehen des Adapters sollte ein Stift in die Bohrung am Adapterflansch eingesetzt werden. Lösen Sie die Adapter-Schraube vor dem Einstellen des Adapters.

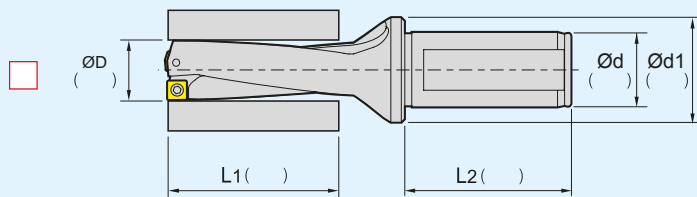
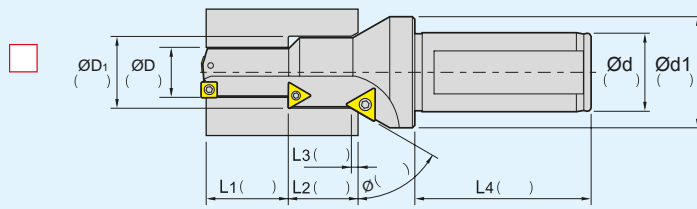
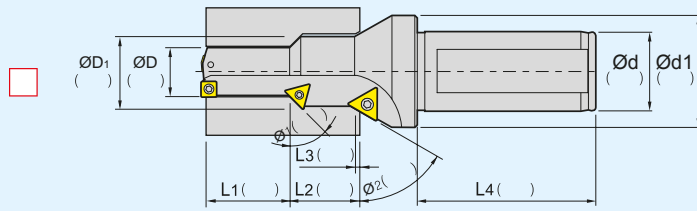
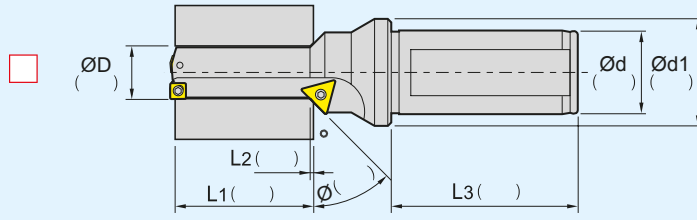
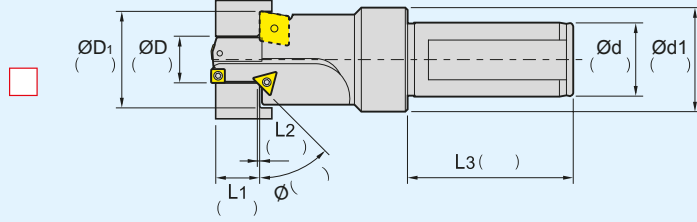

• Soğutma Tipi / Coolant type / Kühlmittelanschluss

- Yağ Deliği Dalma Kismında
Oil Hole On the Plunge Part
Kühlmittelzuführung über den Bund
- Yağ Deliği Şaft Kismında
"Oil hole On the Shank"
Kühlmittelbohrung durch den Schaft

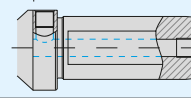

• Delik Tipi / Hole Type / Bohrungstyp

- Kapalı Delik
Blind Hole
Grundbohrung
- Açık Delik
Thru Hole
Durchgangsbohrung

• Şaft Tipleri / Types of Shank / Schaftausführung

- Düz Tip
Flat Type
Bohrungstyp
- Weldon Tip
Weldon Type
Weldon-Schaft
- Eğimli Yargı Tipi
Whistle Notch Type
Whistle-Notch-Schaft

• Yargı Bağlama Yeri / Location of Side Lock / Position der Spannfläche

- Dış Uca Parellel (Standart)
Parallel to Peripheral Insert (Standard)
Parallel zur äußeren Wendeplatte
- Dış Uca 90° Açılı
90° angle to peripheral insert
90° außen abgewinkelt
- Dış Uca 150° Açılı
150° angle to peripheral insert
150° außen abgewinkelt
- Dış Uca 180° Açılı
180° angle to peripheral insert
180° außen abgewinkelt

• Not / Note / Hinweis :

- Şu Anki Kullanılan Takım / Currently Using Tool
- Aktuell verwendetes Werkzeug
- Şu Anki Kesme Durumu / Current Cutting Condition
- Aktuelle Schnittbedingungen
- RPM ya da vc(m/min) / - RPM or vc(m/min)
- Umdrehungen pro Minute oder vc (m/min.)
- vf(mm/min) ya da fn(mm/rev)
- vf(mm/min) or fn(mm/rev) or fn (mm/Umdr.)
- Kesme Derinliği / Depth of Cut(mm)
- Schnitttiefe (mm)
- Ölçülen Standart Takım Ömrü / Standard of Measuring Tool Life
- Standzeit des Werkzeugs
- Şu Anki Kullanılan Makinalar / Currently Using Machine
- Aktuell eingesetzte Maschine
- İşleme Merkezi / Machining Center
- Bearbeitungszentrum
- Genel Torna / General Lathe
- Drehmaschine
- CNC Torna / CNC Lathe
- CNC-Drehmaschine



*konusulan
the spoken kalite...
quality...*

EKONOMİK KESİCİLER

EKONOMİK KESİCİLER

ECONOMIC CUTTING TOOLS

MULTIFUNKTIONALES DREH- UND BOHRWERKZEUG





AKKO **A** **EK** **R** - **D2.25** x **20**

X **C** ■ ■ **10** **T3** **04**

2 Kesiş Stili / Cutter Style / Werkzeugtyp
EK : Ekonomik Kesici / Economic Cutting
Multifunktionales Dreh- und Bohrwerkzeug

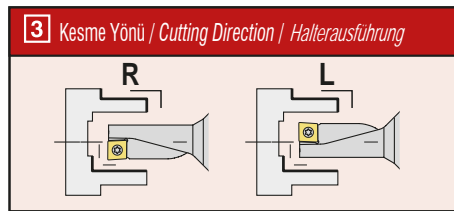

11 Kalınlık / Thickness / Dicke

01 s=1.59
T1 s=1.98
02 s=2.38
T2 s=2.78
03 s=3.18
T3 s=3.97
04 s=4.76
05 s=5.56
06 s=6.35
07 s=7.94
09 s=9.52

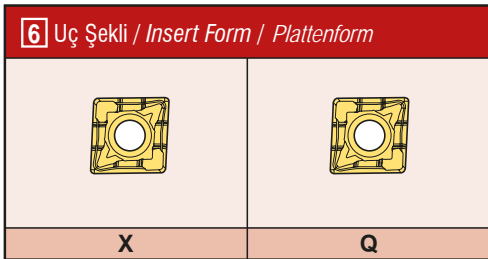
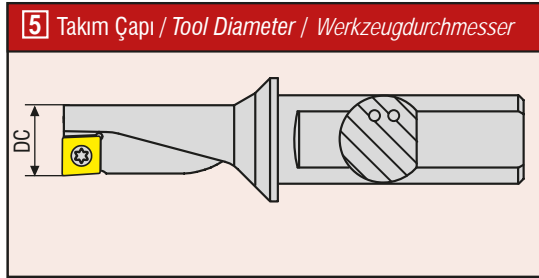
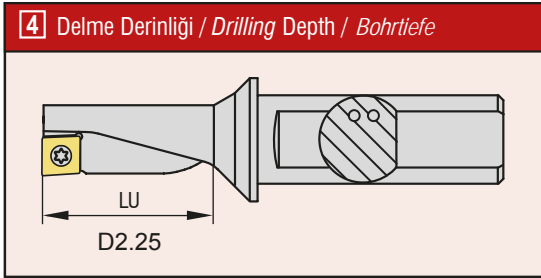

8 Toleranslar / Tolerance Classes / Toleranzen

	IC	M	S
A	± 0.025	± 0.005	± 0.025
C	± 0.025	± 0.013	± 0.025
E	± 0.025	± 0.025	± 0.025
F	± 0.013	± 0.005	± 0.025
G	± 0.025	± 0.025	± 0.130
H	± 0.013	± 0.013	± 0.025
J	± 0.05-0.15	± 0.005	± 0.025
K	± 0.05-0.15	± 0.013	± 0.025
L	± 0.05-0.15	± 0.025	± 0.025
M	± 0.05-0.15	± 0.08-0.20	± 0.130
N	± 0.05-0.15	± 0.08-0.20	± 0.025
U	± 0.08-0.25	± 0.13-0.38	± 0.130

IC : Daire Ölçüsü / Inscribed Circle
M : Şekle Göre / Refer to Figure
S : Kalınlık / Thickness

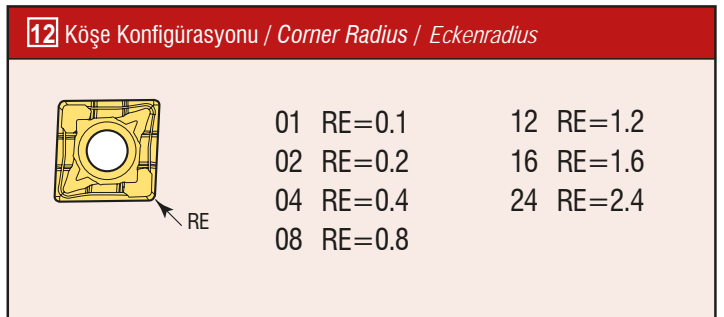
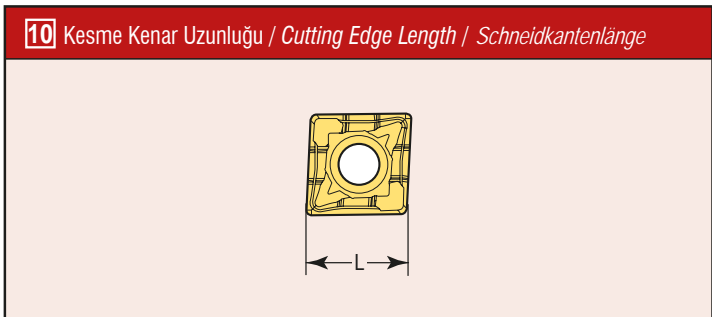
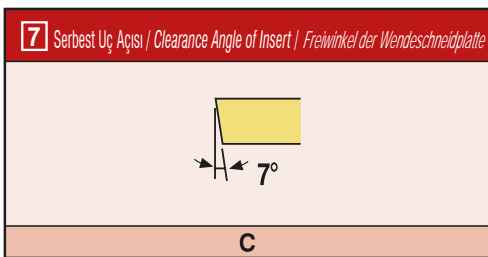
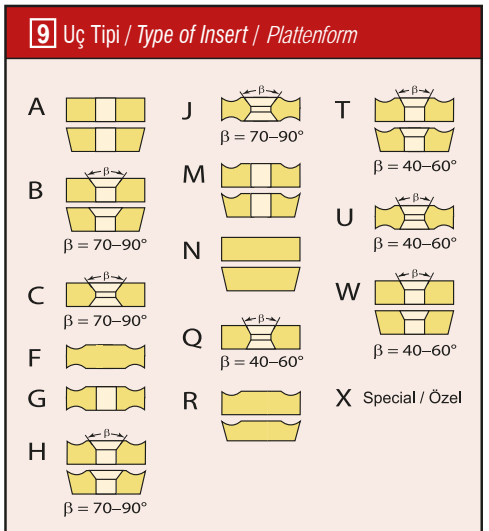

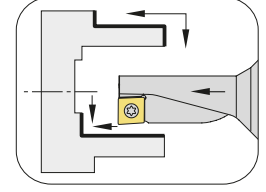
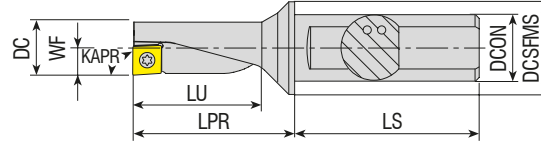

Takım Kodu Ordering Code Bestell-Bezeichnung	Stok Stock Lager		Takım Ölçüleri (mm) Dimension (mm) Abmessung (mm)							Kesici Uç Insert Wendeschneidplatte	Yedek Parçaları / Spare Parts / Ersatzteile	
	R	L	DC	DCON	DCSFMS	LU	LPR	LS	WF	Sıkma Vidası Screw Schraube	Tork Anahtar Torx Key Torx-Schlüssel	
AEKR/L-D2.25X8 XC.. 040104	●	●	8	10	12	18	22	38	4	XC.. 040104	3006-M1.8x4	80-T06
AEKR/L-D2.25X10 XC.. 050204	●	●	10	12	16	22.5	27.5	42	5	XC.. 050204	3006-M2x4	80-T07
AEKR/L-D2.25X12 XC.. 060204	●	●	12	16	20	27	33	45	6	XC.. 060204	3007-M2.2x5	80-T08
AEKR/L-D2.25X14 XC.. 070304	●	●	14	16	20	31.5	38	45	7	XC.. 070304	3008-M2.5x6	80-T08
AEKR/L-D2.25X16 XC.. 080304	●	●	16	20	25	36	44	50	8	XC.. 080304	3008-M3x6	80-T15
AEKR/L-D2.25X18 XC.. 09T304	●	●	18	25	32	40.5	53.5	56	9	XC.. 09T304	4015-M3.5x9	80-T20
AEKR/L-D2.25X20 XC.. 10T304	●	●	20	25	32	45	55	56	10	XC.. 10T304	4020-M4.5x10	80-T20
AEKR/L-D2.25X25 XC.. 130404	●	●	25	32	40	56.5	69	60	12.5	XC.. 130404	4020-M4.5x12	
AEKR/L-D2.25X32 XC.. 170504	●	●	32	32	50	72	88	60	16	XC.. 170504		

R: Sağ / Right / Rechts L: Sol/Left/Links

● Stokta / In Stock / Auf Lager ○ Stokta Yok / Non Stock Item / Kein Lagerartikel, Lieferzeit auf Anfrage
 CRTZT-ISCR-TGTC-KRLY Ucuna Uygunudur. / Compatible with CRTZT-ISCR-TGTC-KRLY Insert.

Kompatibel mit CRTZT-ISCR-TGTC-KRLY Wendeschneidplatten.

Sipariş Örneği/Ordering Example/Bestellbeispiel
 1 ad./pcs./stück AEKR-D2.25X8 XC.. 040104

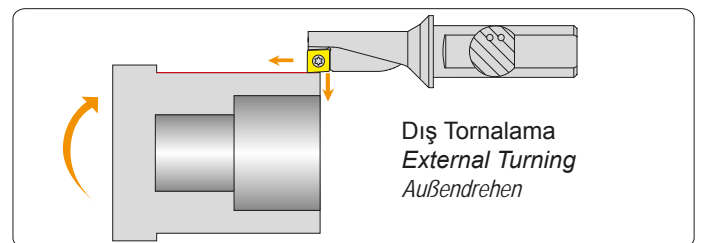
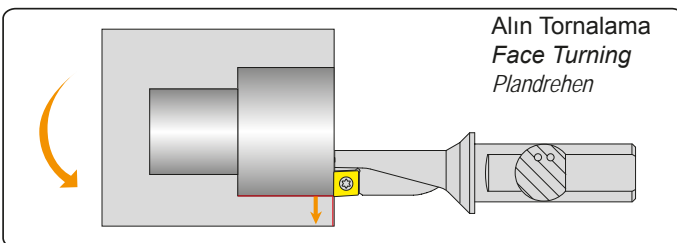
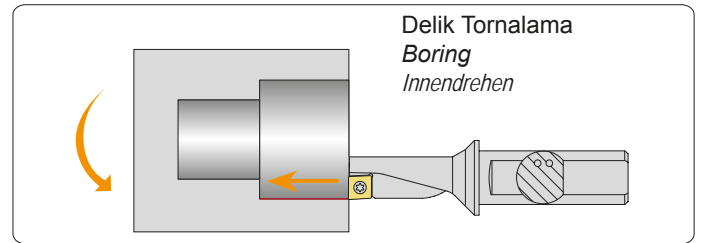
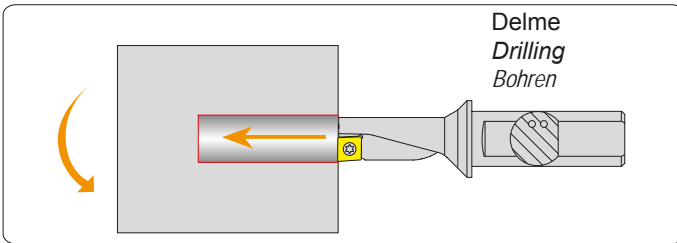
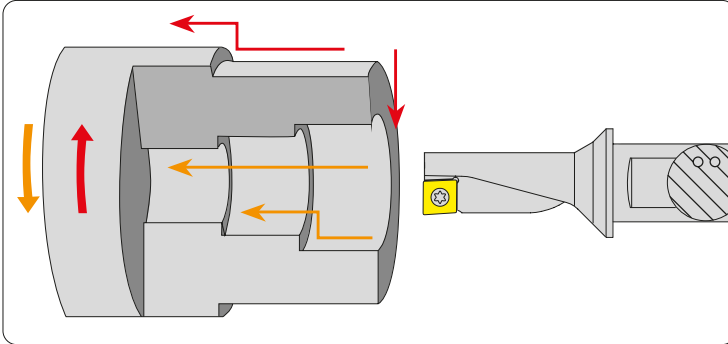

BARALAR

AYARLI DELİK İŞLEME BARALARI
ADJUSTABLE BORING HEADS
EINSTELLBARE SPINDELKÖPFE

konusulan
the spoken kalite...
quality...



AKKO **A** **BH** **R** - **D18x22**

W16 - **L90** - **CC06**

2 Kesiş Stili / Cutter Style / Werkzeugtyp

BH : Delik İşleme / Boring Head
Spindelkopf

3 İşlem Tipi / Cutter Type / Einsatzgebiet

R : Kaba Baralama / Rough Boring
Schruppbearbeitung
F : Hassas Baralama / Fine Boring
Schlichtbearbeitung

5 Montaj Formu / Assembly Form / Schaftform

W : Weldon

4 Ölçü Aralığı / Boring Range / Bohrbereich

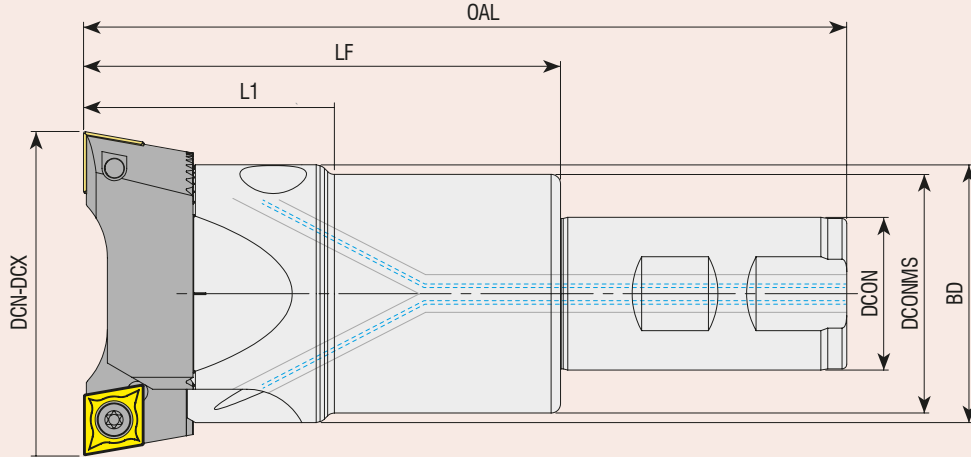

6 Takım Boyu / Tool Length / Werkzeuglänge

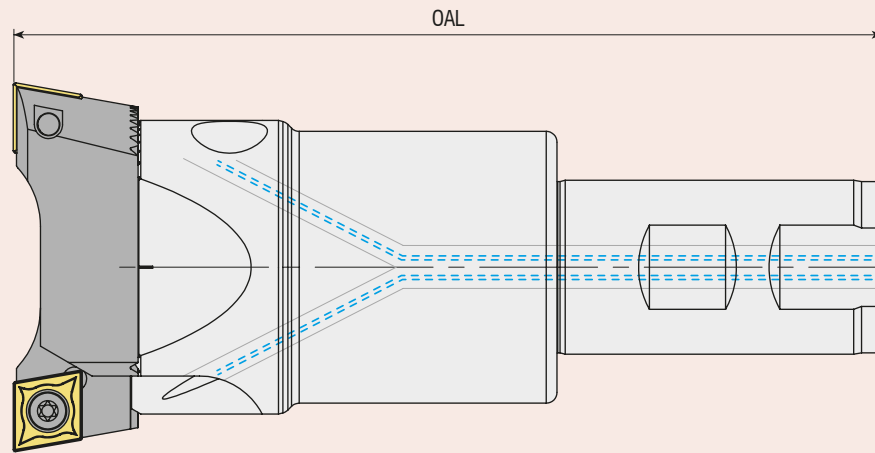

7 Kesici Uç / Insert / Wendeschneidplatte

CC06 : CC.. 0602..
CC09 : CC.. 09T3..
CC12 : CC.. 1204..

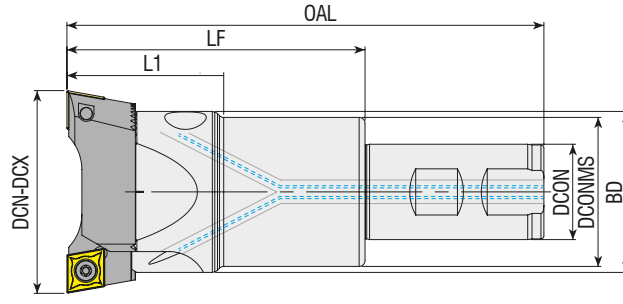

DIN 1835

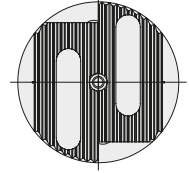

Takım Kodu
Ordering Code
Bestell-Bezeichnung

Stok
Stock
Lager

Takım Ölçüleri (mm)
Dimension (mm)
Abmessung (mm)

Kartuş
Cartridge
Kurzdrehhalter

Bara Gövde Takım Kodu
Boring Head Body Code
Trägerwerkzeug-Bezeichnung

Ölçü Aralığı
Boring Range
Bohrbereich
DCN-DCX

DCON

DCONMS

BD

OAL

LF

L1

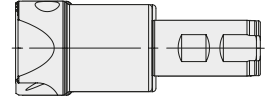
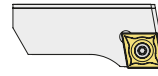

	●	Ölçü Aralığı Boring Range Bohrbereich DCN-DCX	DCON	DCONMS	BD	OAL	LF	L1		
ABHR-D18x22-W16-L90-CC06	●	18-22	16	-	-	90	42	-		ABHRS-D16x42-W16-L90
ABHR-D18x22-W16-L150-CC06	●	18-22	16	-	-	150	102	-	AK.. 18-22	ABHRS-D16x102-W16-L150
ABHR-D18x22-W16-L200-CC06	●	18-22	16	-	-	200	152	-		ABHRS-D16x152-W16-L200
ABHR-D22x28-W20-L100-CC06	●	22-28	20	-	-	100	50	-		ABHRS-D20x50-W20-L100
ABHR-D22x28-W20-L150-CC06	●	22-28	20	-	-	150	100	-	AK.. 22-28	ABHRS-D20x100-W20-L150
ABHR-D22x28-W20-L200-CC06	●	22-28	20	-	-	200	150	-		ABHRS-D20x150-W20-L200
ABHR-D28x38-W20-L110-CC06	●	28-38	20	25	-	110	60	-		ABHRS-D25x60-W20-L110
ABHR-D28x38-W20-L160-CC06	●	28-38	20	25	-	160	110	-	AK.. 28-38	ABHRS-D25x110-W20-L160
ABHR-D28x38-W20-L230-CC06	●	28-38	20	25	-	230	180	-		ABHRS-D25x180-W20-L230
ABHR-D36x50-W25-L120-CC06	●	36-50	25	32	-	120	64	-		ABHRS-D32X64-W25-L120
ABHR-D36x50-W25-L170-CC06	●	36-50	25	32	-	170	114	-	AK.. 36-50	ABHRS-D32X114-W25-L170
ABHR-D36x50-W25-L250-CC06	●	36-50	25	32	-	250	194	-		ABHRS-D32X194-W25-L250
ABHR-D36x50-W25-L120-CC09	●	36-50	25	32	-	120	64	-		ABHRS-D32X64-W25-L120
ABHR-D36x50-W25-L170-CC09	●	36-50	25	32	-	170	114	-	AK.. 36-50-09	ABHRS-D32X114-W25-L170
ABHR-D36x50-W25-L250-CC09	●	36-50	25	32	-	250	194	-		ABHRS-D32X194-W25-L250
ABHR-D50x68-W32-L140-CC09	●	50-68	32	40	-	140	80	-		ABHRS-D40x80-W32-L140
ABHR-D50x68-W32-L200-CC09	●	50-68	32	40	-	200	140	-	AK.. 50-68	ABHRS-D40x140-W32-L200
ABHR-D50x68-W32-L280-CC09	●	50-68	32	40	-	280	220	-		ABHRS-D40x220-W32-L280
ABHR-D50x68-W32-L140-CC12	●	50-68	32	40	-	140	80	-		ABHRS-D40x80-W32-L140
ABHR-D50x68-W32-L200-CC12	●	50-68	32	40	-	200	140	-	AK.. 50-68-12	ABHRS-D40x140-W32-L200
ABHR-D50x68-W32-L280-CC12	●	50-68	32	40	-	280	220	-		ABHRS-D40x220-W32-L280
ABHR-D68x90-W32-L160-CC12	●	68-90	32	50	54	160	100	50		ABHRS-D50x100-W32-L160
ABHR-D68x90-W32-L210-CC12	●	68-90	32	50	54	210	150	50	AK.. 68-90	ABHRS-D50x150-W32-L210
ABHR-D68x90-W32-L280-CC12	●	68-90	32	50	54	280	220	50		ABHRS-D50x220-W32-L280
ABHR-D90x120-W32-L140-CC12	●	90-120	32	63	72	140	80	63		ABHRS-D63x80-W32-L140
ABHR-D90x120-W40-L200-CC12	●	90-120	40	63	72	200	130	63	AK.. 90-120	ABHRS-D63x130-W40-L200
ABHR-D90x120-W40-L300-CC12	●	90-120	40	63	72	300	230	63		ABHRS-D63x230-W40-L300
ABHR-D120x160-W40-L210-CC12	●	120-160	40	80	95	210	140	75	AK.. 120-160	ABHRS-D80x140-W40-L210
ABHR-D120x160-W40-L300-CC12	●	120-160	40	80	95	300	230	75		ABHRS-D80x230-W40-L300
ABHR-D160x200-W40-L210-B-CC12	●	160-200	40	80	95	210	140	75	AK.. 160-800	ABHRS-D80x140-W40-L210
ABHR-D160x200-W40-L300-B-CC12	●	160-200	40	80	95	300	230	75		ABHRS-D80x230-W40-L300

R: Sağ / Right / Rechts L: Sol/Left/Links

● Stokta / In Stock / Auf Lager ○ Stokta Yok / Non Stock Item / Kein Lagerartikel, Lieferzeit auf Anfrage
Siparişe, gövde ve kartuş set olarak verilecektir. / When ordered, body and cartridge will be sent as set.
Bei Bestellung werden Körper und Kassetten als Set geliefert.

Sipariş Örneği/Ordering Example/Bestellbeispiel
1 ad./pcs./stück ABHR-D18x22-W16-L90-CC06

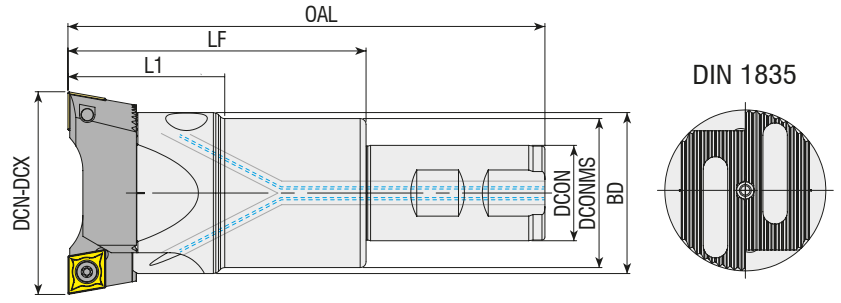

Takım Kodu Ordering Code Bestell-Bezeichnung	Stok Stock Lager	Ölçü Aralığı Boring Range Bohrbereich DCN-DCX	Takım Ölçüleri (mm) Dimension (mm) Abmessung (mm)					Yedek Parçaları / Spare Parts / Ersatzteile					
			DCON	DCONMS	BD	OAL	LF	L1	Montaj Vidası Mounting Screw Befestigungsschraube	Montaj Vida Anahtarı Mounting Screw Key Innenbohrschlüssel	Pabuç Clamp Spannspratze	Ayar Vidası Adjusting Screw Einstellschraube	Ayar Vida Anahtarı Allen Key Innenbohrschlüssel
ABHRS-D16x42-W16-L90	●	18-22	16	-	-	90	42	-					
ABHRS-D16x102-W16-L150	●	18-22	16	-	-	150	102	-	2525-M3x14	AAL-02-2.5	ABKS-D16	2715-M3x4	
ABHRS-D16x152-W16-L200	●	18-22	16	-	-	200	152	-					
ABHRS-D20x50-W20-L100	●	22-28	20	-	-	100	50	-					
ABHRS-D20x100-W20-L150	●	22-28	20	-	-	150	100	-	2503-M4x15	AAL-03-3	ABKS-D20	2715-M3x5	AAL-09-1.5
ABHRS-D20x150-W20-L200	●	22-28	20	-	-	200	150	-					
ABHRS-D25x60-W20-L110	●	28-38	20	25	-	110	60	-					
ABHRS-D25x110-W20-L160	●	28-38	20	25	-	160	110	-	2503-M4x20	AAL-03-3	ABKS-D25	2715-M3x8	
ABHRS-D25x180-W20-L230	●	28-38	20	25	-	230	180	-					
ABHRS-D32X64-W25-L120	●	36-50	25	32	-	120	64	-					
ABHRS-D32X114-W25-L170	●	36-50	25	32	-	170	114	-	2504-M5x25	AAL-05-4	ABKS-D32	2702-M4x12	AAL-01-2
ABHRS-D32X194-W25-L250	●	36-50	25	32	-	250	194	-					
ABHRS-D40x80-W32-L140	●	50-68	32	40	-	140	80	-					
ABHRS-D40x140-W32-L200	●	50-68	32	40	-	200	140	-	2505-M6x30	AAL-07-5	ABKS-D40	2725-M5x16	
ABHRS-D40x220-W32-L280	●	50-68	32	40	-	280	220	-					AAL-02-2.5
ABHRS-D50x100-W32-L160	●	68-90	32	50	54	160	100	50					
ABHRS-D50x150-W32-L210	●	68-90	32	50	54	210	150	50	2506-M8x35	AAL-08-6	ABKS-D50	2725-M5x12	
ABHRS-D50x220-W32-L280	●	68-90	32	50	54	280	220	50					
ABHRS-D63x80-W32-L140	●	90-120	32	63	72	140	80	63					
ABHRS-D63x130-W40-L200	●	90-120	40	63	72	200	130	63	2508-M10x40	AAL-11-8	ABKS-D63	2703-M6x16	AAL-03-3
ABHRS-D63x230-W40-L300	●	90-120	40	63	72	300	230	63					
ABHRS-D80x140-W40-L210	●	120-160	40	80	95	210	140	75	2510-M12x40				
ABHRS-D80x230-W40-L300	●	120-160	40	80	95	300	230	75		AAL-12-10	ABKS-D80	2704-M8x25	AAL-05-4
ABHRS-D80x140-W40-L210	●	160-200	40	80	95	210	140	75	2510-M12x40				
ABHRS-D80x230-W40-L300	●	160-200	40	80	95	300	230	75					

R: Sağ / Right / Rechts L: Sol/Left/Links
● Stokta / In Stock / Auf Lager ○ Stokta Yok / Non Stock Item / Kein Lagerartikel, Lieferzeit auf Anfrage

Sipariş Örneği/Ordering Example/Bestellbeispiel
1 ad./pcs./stück ABHRS-D16x42-W16-L90

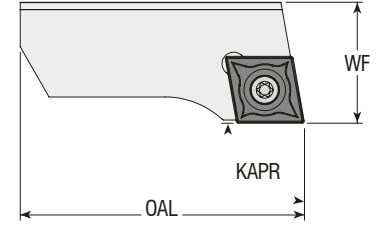

Takım Kodu Ordering Code Bestell-Bezeichnung	Stok Stock Lager	Takım Ölçüleri (mm) Dimension (mm) Abmessung (mm)			Kesici Uç Insert Wendeschneidplatte	Yedek Parçaları / Spare Parts / Ersatzteile		
		Ölçü Aralığı Boring Range	WF	OAL		Sıkma Vidası Screw Schraube	Tork Anahtar Torx Key Torx-Schlüssel	
AKSR 18-22	●	18-22	9	15	CC.. 0602..	4008-M2.5x6	80-T08	
AKSR 22-28	●	22-28	10	19				
AKSR 28-38	●	28-38	13	23				
AKSR 36-50	●	36-50	16	32	CC.. 09T3..	4015-M3.5x8	80-T15	
AKSR 36-50-09	●	36-50	16	32				
AKSR 50-68	●	50-68	20	40				
AKSR 50-68-12	●	50-68	20	40	CC.. 1204..	1020-M5x11	80-T20	
AKSR 68-90	●	68-90	23	54				
AKSR 90-120	●	90-120	28	70				
AKSR 120-160	●	120-160	32	95				
AKSR 160-800	●	160-800	32	120				

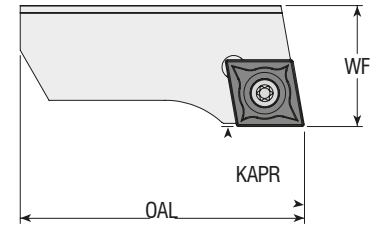

Takım Kodu Ordering Code Bestell-Bezeichnung	Stok Stock Lager	Takım Ölçüleri (mm) Dimension (mm) Abmessung (mm)			Kesici Uç Insert Wendeschneidplatte	Yedek Parçaları / Spare Parts / Ersatzteile		
		Ölçü Aralığı Boring Range	WF	OAL		Sıkma Vidası Screw Schraube	Tork Anahtar Torx Key Torx-Schlüssel	
AKCR 28-38	●	28-38	12.8	23	CC.. 0602..	4008-M2.5x6	80-T08	
AKCR 36-50	●	36-50	15.8	32				
AKCR 36-50-09	●	36-50	15.8	32				
AKCR 50-68	●	50-68	19.7	40	CC.. 09T3..	4015-M3.5x8	80-T15	
AKCR 50-68-12	●	50-68	19.7	40				
AKCR 68-90	●	68-90	22.7	54				
AKCR 90-120	●	90-120	27.7	70	CC.. 1204..	1020-M5x11	80-T20	
AKCR 120-160	●	120-160	31.7	95				
AKCR 160-800	●	160-800	31.7	120				

R: Sağ / Right / Rechts L: Sol/Left/Links

● Stokta / In Stock / Auf Lager ○ Stokta Yok / Non Stock Item / Kein Lagerartikel, Lieferzeit auf Anfrage
ISO Ucuna Uygunudur. / Compatible with ISO Insert. Kompatibel mit ISO Wendeplatten.

Sipariş Örneği/Ordering Example/Bestellbeispiel
1 ad./pcs./stück AKSR 18-22

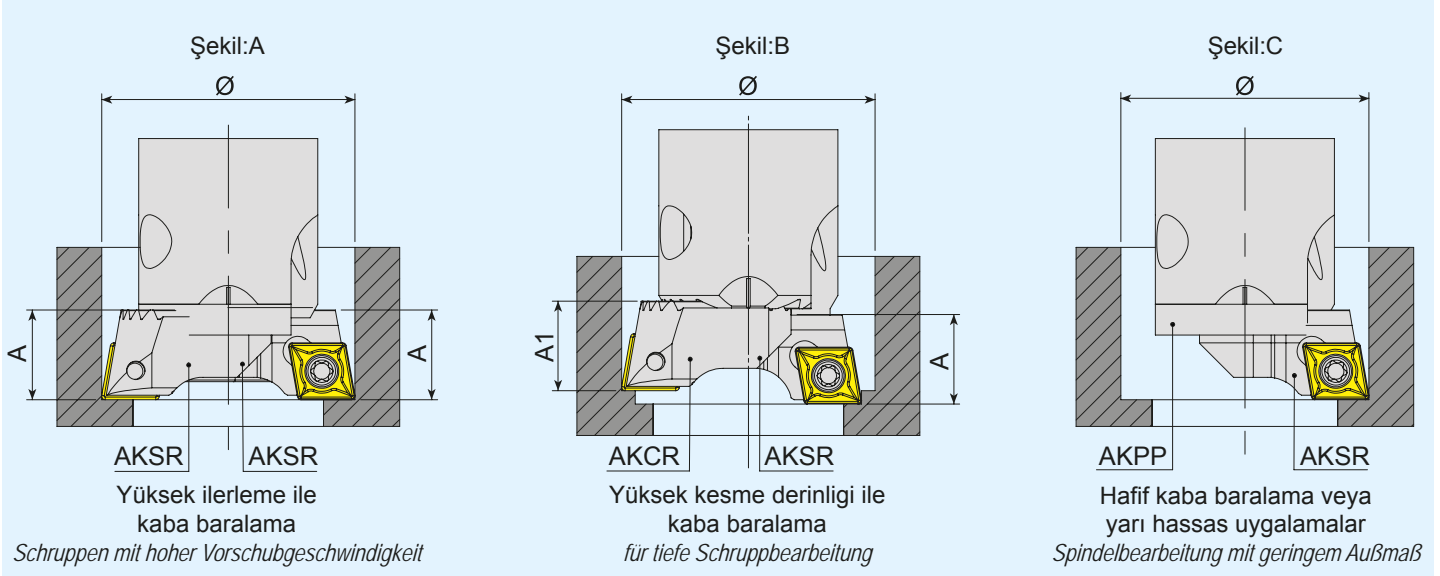

1. Kesici kenarların radyal ayarı, takım ölçme ekipmanı ile yapılmalıdır.
2. İki uçlu baralama takımı, ağır talaş kaldırma işlemini içeren kaba baralama işlemleri içindir.
Çift uçlu baralama takımı ile:
 - Yüksek ilerleme oranında kaba baralama işlemleri için, aynı düzlemdeki iki AKSR kartuşu, aynı radyal mesafeye ayarlanır. (Şekil A)
 - Aynı düzlemde olmayan bir AKCR kartuşu ve bir AKSR kartuşu yüksek derinlikte kaba baralama işlemleri için kullanılır. (Şekil B)
 - i. Kaba baralama işleminde, alınacak paso miktarı tam olarak ikiye bölünüp, düzgün bir kesim sağlanmış olur, ancak bu durumda tur başına ilerleme tek ağız olarak hesaplanmalıdır. ($f=f_1$)
 - ii. Hassas baralama işleminde, alınacak paso miktarı AKSR kartuş için ara kaba olarak ve AKCR kartuş için hassas bara olarak çaplar ayarlanır ve bu sayede bazı ara kaba işleme ihtiyacı kalmaz.
3. Tek kartuşlu baralama takımları, normal talaş kaldırma işlemini içeren kaba ve hassas baralama işlemleri içindir. Dişleri koruma plakası, AKPP daima kullanılmalıdır. (Şekil C)

1. Radial setting of the cutting edges should be carried out with tool presetting equipment.
2. Boring bars fitted with two insert pockets are for roughing operations involving heavy chip removal.
The double-insert boring bars include:
 - Two AKSR cartridges on the same plane with two cutting edges set at identical radial distance for high feed rate roughing operations. (fig. A)
 - An AKCR cartridge and an AKSR cartridge not on the same plane for high-depth roughing operations. (fig. B)
 - i. With the rough boring operation, this allows double the cutting width, using only a single feed rate. ($f=f_1$)
 - ii. With the finish boring operation, the cutting width is divided so that some of the intermediate machining can be omitted.
3. Boring bars fitted with a single cartridge are for roughing and finishing operations involving normal chip removal. The serrated surface protection plate AKPP should always be used (fig. C)

1. Die radiale Einstellung der Schneiden sollte auf einem Voreinstellgerät durchgeführt werden.
2. Spindelköpfe, die mit 2 Kassetten bestückt sind, werden für die Schrubbearbeitung eingesetzt.
Doppelte Kassetten beinhalten:
 - Für die Schrubbearbeitung mit hoher Vorschubgeschwindigkeit sind zwei AKSR-Kassetten in derselben Höhe auf denselben radialen Abstand einzustellen (Abbildung A)
 - Eine AKCR-Kassette und eine AKSR-Kassette, die nicht in derselben Ebene liegen, werden für tiefe Schrubbearbeitungen eingesetzt.
 - i. Bei einer Schrubbearbeitung kann die Schnitttiefe verdoppelt werden. Bitte nur eine Schneide zur Vorschubberechnung verwenden ($f=f_1$).
 - ii. Bei der Schlichtbearbeitung wird die Schnitttiefe halbiert. Weitere zusätzliche Bearbeitungsdurchgänge werden überflüssig.
3. Bohrköpfe mit einer einzelnen Kassette können sowohl für Schlicht- als auch für Schrubb-Operationen eingesetzt werden. Voraussetzung hierfür ist eine gute Spanabfuhr. Zum Schutz der verzahnten Oberfläche des Bohrkörpers sollte immer die Abdeckung AKPP verwendet werden (siehe Abb.C).



*konusulan
the spoken kalite...
quality...*

FREZELEME TAKIMLARI
MILLING TOOLS
FRÄSWERKZEUGE



AKKO **A** **EM** **90** **L** - **A** **P** **10**

1 2 3 4 5 6 7

D12 - **W16** - **L100** - **Z01** - **H**

8 9 10 11 12

2 Kesiş Stili / Cutter Style / Fräswerkzeug-Typ

FM: Yüzey Frezeleme Takımları / Face Milling Tools / Eck-und Planfräsköpfe
EM: Alın ve Yüzey Parmak Frezeleri / End Face Milling Tools / Schafffräser
CM: Pah Kırma Parmak Frezeleri / Chamfering End Milling Tools / Fasfräser
HM: Helis Parmak Frezeleri / Helix End Milling Tools / Schafffräser Helix
TSM: T Kanal Frezeleri / T Slot Milling Tools / T-Nutenfräser
HFM: Yüksek İlerleme Frezeleme Takımları / High Feed Milling Tools / Fräser für hohe Vorschübe
PMR: Küresel Uçlu Parmak Frezeleri / Ball Nose End Milling Tools / Kugel und Koperfräser
SDM: Disk Frezeler / Slot Disc Milling / Scheibenfräser
CBM: Silindirik Alyan Başlı Vida Havşalarını Açma Frezeleri / Countersink Milling Tool for Cylindrical Allen Head Screws
Fräswerkzeug für zylindrische Inbusschrauben

3 Freze Yanaşma Açısı / Lead Angle / Anstellwinkel

90° - 75° - 60° - 45°
20° - 15° - 11° - 5° - 0°

4 Freze Yanaşma Açısı / Lead Angle / Ausführung

L: Sol - Left / Links
C: Baskı Pabucu - Clamp / Spannpratze
S: Altlık - Shim / Unterlage
CL: Baskı Pabuçlu Sol Yön - Left Way with Clamp
Spannspratze links
CS: Baskı Pabuçlu Altlıklı - Clamp with Shim
Spannspratze mit Unterlage
CSL: Baskı Pabuçlu Altlıklı Sol Yön - Left Way Clamp with Shim
Spannspratze mit Unterlage Links

5 Uç Tipi / Type of Insert / Plattenform

C	D	E	K
L	R	S	T
V	W	A	B
H	M	O	P

6 Serbest Uç Açısı / Clearance angle of Insert
Freiwinkel der Wendeschneidplatte

A	B	C
D	E	F
G	N	P

7 Kesme Kenar Uzunluğu
Cutting Edge Length
Länge der Schneidkante

A	L
R	S
T	

8 Takım Çapı / Tool Diameter / Werkzeug-ø

9 Montaj Formu ve Çapı / Assembly Form and Diameter / Schaft-ø und Form

A, B, C, D: ISO'ya göre montaj formu / Assembly Form and Diameter / Art der Montage und Durchmesser
C: Silindirik Şaft / Cylindrical Shank / Zylindrischer Schaft
W: Weldon

10 Takım Boyu / Tool Length / Werkzeug Länge

11 Etkili Diş Adedi / Number of Effective Tooth / Effektive Zahnzahl

12 İçten Soğutmalı / With Coolant Hole / Innenkühlung

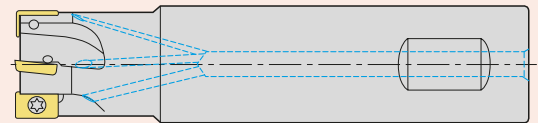

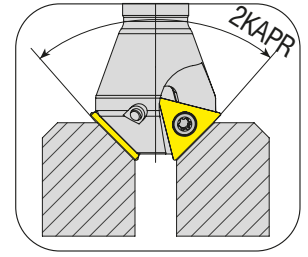
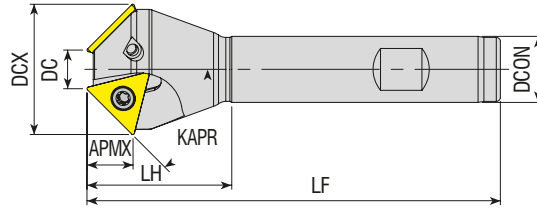

Takım Kodu
Ordering Code
Bestell-Bezeichnung

Stok
Stock
Lager



Takım Ölçüleri (mm)
Dimension (mm)
Abmessung (mm)

Kesici Uç
Insert
Wendeschneidplatte

Yedek Parçaları / Spare Parts / Ersatzteile

Sıkma Vidası
Screw
Schraube

Tork Anahtar
Torx Key
Torx-Schlüssel

	KAPR	DC	DCX	DCON	LF	LH	ZEFP	APMX						
ACM10-TC16-D17X22-W16-L90-Z01	10°	17	22	16	90	30	1	15.2	TC.T 16T304					
ACM15-TC16-D17X24-W16-L90-Z01	15°	17	24	16	90	30	1	14.9						
ACM15-TC16-D22X29-W16-L100-Z01	15°	22	29	16	100	30	1	14.9						
ACM15-TC16-D30X37-W20-L100-Z02	15°	30	37	20	100	35	2	14.9						
ACM15-TC16-D35X42-W20-L100-Z03	15°	35	42	20	100	38	3	14.9						
ACM15-TC16-D52X59-W25-L110-Z03	15°	52	59	25	110	40	3	14.9						
ACM17.5-TC16-D17X25-W16-L90-Z01	17.5°	17	25	16	90	30	1	14.7						
ACM18.5-TC16-D21.3X30-W20-L100-Z02	18.5°	21.3	30	20	100	30	2	13.5				TC.T 16T308		
ACM20-TC16-D12X22-W16-L100-Z01	20°	12	22	16	100	30	1	14.4				TC.T 16T304	4015-M3.5x9	80-T15
ACM20-TC16-D17X27-W16-L100-Z01	20°	17	27	16	100	30	1	14.4						
ACM20-TC16-D23X33-W20-L100-Z02	20°	23	33	20	100	30	2	14.4						
ACM20-TC16-D28X38-W20-L100-Z02	20°	28	38	20	100	35	2	14.4						
ACM20-TC16-D35X45-W20-L100-Z03	20°	35	45	20	100	40	3	14.4						
ACM20-TC16-D39X49-W20-L100-Z03	20°	39	49	20	100	40	3	14.4						
ACM20-TC16-D45X55-W25-L110-Z03	20°	45	55	25	110	40	3	14.4						
ACM20-TC16-D51X61-W25-L110-Z03	20°	51	61	25	110	40	3	14.4						
ACM22.5-TC16-D17X28-W16-L100-Z01	22.5°	17	28	16	100	30	1	14.2						
ACM25-TC16-D17X29-W16-L100-Z01	25°	17	29	16	100	30	1	13.9						
ACM30-TC16-D6X20-W16-L100-Z01	30°	6	20	16	100	30	1	13.3	TC.T 090204	3007-M2.2x5	80-T07			
ACM30-TC16-D15X30-W16-L100-Z01	30°	15	30	16	100	30	1	13.3						
ACM30-TC16-D17.5X32.5-W20-L100-Z02	30°	17.5	32.5	20	100	30	2	13.3						
ACM30-TC16-D20X35-W16-L100-Z02	30°	20	35	16	100	35	2	13.3						
ACM30-TC16-D30X45-W20-L100-Z02	30°	30	45	20	100	40	2	13.3						
ACM30-TC16-D35X50-W20-L100-Z03	30°	35	50	20	100	40	3	13.3						
ACM30-TC16-D45X60-W25-L110-Z03	30°	45	60	25	110	40	3	13.3						
ACM45-TC09-D7X18-W16-L100-Z02	45°	7	18	16	100	25	2	5.9						
ACM45-TC11-D11X24-W16-L100-Z02	45°	11	24	16	100	25	2	6.9				TC.T 110204	3008-M2.5x6	80-T08
ACM45-TC16-D5X26-W16-L100-Z01	45°	5	26	16	100	30	1	10.8				TC.T 16T304	4015-M3.5x9	80-T15
ACM45-TC16-D10X31-W16-L100-Z02	45°	10	31	16	100	35	2	10.8						
ACM45-TC16-D10X31-W20-L100-Z02	45°	10	31	20	100	35	2	10.8						
ACM45-TC16-D18X39-W16-L100-Z02	45°	18	39	16	100	40	2	10.8						
ACM45-TC16-D18X39-W20-L100-Z02	45°	18	39	20	100	40	2	10.8						
ACM45-TC16-D20X41-W20-L100-Z02	45°	20	41	20	100	40	2	10.8						
ACM45-TC16-D30X51-W20-L100-Z02	45°	30	51	20	100	40	2	10.8						
ACM55-TC16-D16X40-W20-L100-Z03	55°	16	40	20	100	40	3	8.7						
ACM62-TC16-D14X40-W20-L100-Z03	62°	14	40	20	100	40	3	7.1						
ACM72-TC16-D14X42-W20-L100-Z03	72°	14	42	20	100	40	3	4.6						

R: Sağ / Right / Rechts L: Sol/Left/Links

● Stokta / In Stock / Auf Lager ○ Stokta Yok / Non Stock Item / Kein Lagerartikel, Lieferzeit auf Anfrage
ISO Uçuna Uygundur. / Compatible with ISO Insert. Kompatibel mit ISO Wendeplatten.

Sipariş Örneği/Ordering Example/Bestellbeispiel

1 ad./pcs./stück ACM10-TC16-D17X22-W16-L90-Z01

Kesme Hesabı : S 331 / Cutting Calculation : P 331 / Schnittberechnung : 331

➤ **S-SİSTEM PAH FREZELER**
S-SYSTEM CHAMFERING END MILLS
S-SYSTEM FASFRÄSER

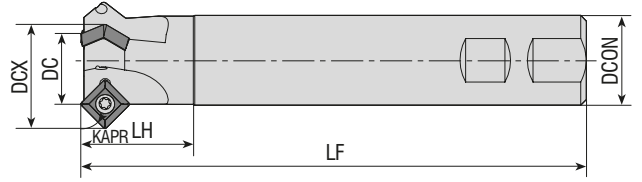

Takım Kodu Ordering Code Bestell-Bezeichnung	Stok Stock Lager	Takım Ölçüleri (mm) Dimension (mm) Abmessung (mm)								Kesici Uç Insert Wendeschneidplatte	Yedek Parçaları / Spare Parts / Ersatzteile	
		KAPR	DC	DCX	DCON	LF	LH	ZEFP	a		Sıkma Vidası Screw Schraube	Tork Anahtar Torx Key Torx-Schlüssel
ACM45-SP1104-D12x26-W20-L150-Z01	●	45°	12	26	20	150	30	1	-	SPGT 110408	4015-M4x9	80-T15
ACM45-SP1104-D25x39-W25-L150-Z02	●	45°	25	39	25	150	35	2	-			
ACM45-SP1104-D32x46-W32-L150-Z03	●	45°	32	46	32	150	40	3	-			

ZCC Ucuna Uygundur. / Compatible with ZCC Insert. Kompatibel mit ZCC Wendeplatten.

➤ **HELİS PAH FREZELEME TAKIMLARI**
HELIX CHAMFER MILLING TOOLS
HELIX-FASFRÄSER

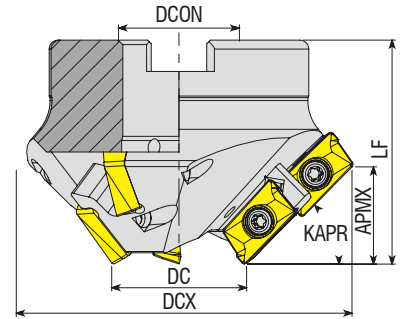

Takım Kodu Ordering Code Bestell-Bezeichnung	Stok Stock Lager	Takım Ölçüleri (mm) Dimension (mm) Abmessung (mm)								Kesici Uç Insert Wendeschneidplatte	Yedek Parçaları / Spare Parts / Ersatzteile	
		ZEFP		KAPR	DC	DCX	DCON	APMX	LF		Sıkma Vidası Screw Schraube	Tork Anahtar Torx Key Torx-Schlüssel
		Toplam Total Gesamt	Etkili Effective Effektiv									
AHM15-AP16-D35x93-A27-Z0306-H	●	6	3	15	35	93	27	8	50	AP. 1604..	4015-M4x11	80-T15
AHM30-AP16-D35x87-A27-Z0306-H	●	6	3	30	35	87	27	15	50			
AHM45-AP16-D35x77-A27-Z0306-H	●	6	3	45	35	77	27	21.5	50			
AHM60-AP16-D35x65-A22-Z0306-H	●	6	3	60	35	65	22	26.5	50			
AHM75-AP16-D35x50-A22-Z0306-H	●	6	3	75	35	50	22	29.5	50			

R: Sağ / Right / Rechts L: Sol/Left/Links

● Stokta / In Stock / Auf Lager ○ Stokta Yok / Non Stock Item / Kein Lagerartikel, Lieferzeit auf Anfrage
 ISO Ucuna Uygundur. / Compatible with ISO Insert. Kompatibel mit ISO Wendeplatten.

Sipariş Örneği/Ordering Example/Bestellbeispiel

1 ad./pcs./stück ACM45-SP1104-D12x26-W20-L150-Z01

Kesme Hesabı : S 331 / Cutting Calculation : P 331 / Schnittberechnung : 331

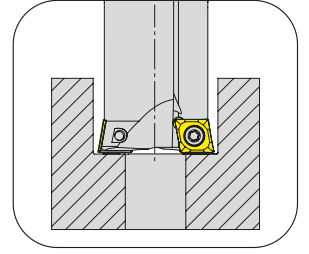
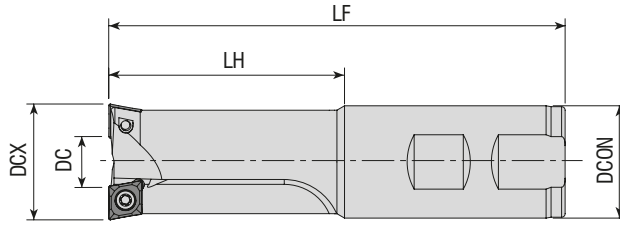

Takım Kodu
Ordering Code
Bestell-Bezeichnung

Stok
 Stock
 Lager

Takım Ölçüleri (mm)
 Dimension (mm)
 Abmessung (mm)

Kesici Uç
 Insert
 Wendeschneidplatte

Yedek Parçaları / Spare Parts / Ersatzteile

Sıkma Vidası
 Screw
 Schraube

Tork Anahtar
 Torx Key
 Torx-Schlüssel

Takım Kodu Ordering Code Bestell-Bezeichnung	Stok Stock Lager	DC	DCX	DCON	LH	LF	Kullanılan Vidalar For Screws Für Schraube	Kesici Uç Insert Wendeschneidplatte	Sıkma Vidası Screw Schraube	Tork Anahtar Torx Key Torx-Schlüssel
ACBM-CC06-D17X6-W16-L150-Z02	●	6	17	16	30	150	-	CC.. 060204	3008-M2.5x6	80-T08
ACBM-CC06-D18X7-W16-L100-Z02-H	●	7	18	16	32	100	M10			
ACBM-CC06-D18X7-W16-L160-Z02-H	●	7	18	16	32	160	M10			
ACBM-CC06-D20X9-W20-L100-Z02-H	●	9	20	20	40	100	M12			
ACBM-CC06-D20X9-W20-L160-Z02-H	●	9	20	20	38	160	M12	CC.. 09T304	4015-M3.5x9	80-T15
ACBM-CC09-D26X8.5-W25-L130-Z02-H	●	8.5	26	25	50	130	M16			
ACBM-CC09-D26X8.5-W25-L200-Z02-H	●	8.5	26	25	50	200	M16			
ACBM-CC09-D33X15.5-W32-L130-Z02-H	●	15.5	33	32	65	130	M20			
ACBM-CC09-D33X15.5-W32-L200-Z02-H	●	15.5	33	32	65	200	M20	SP. 060204	3007-M2.2x5	80-T07
ACBM-SP06-D15X4-W16-L160-Z02-H	●	4	15	16	80	160	M8			

R: Sağ / Right / Rechts L: Sol/Left/Links

● Stokta / In Stock / Auf Lager ○ Stokta Yok / Non Stock Item / Kein Lagerartikel, Lieferzeit auf Anfrage
 ISO Ucuna Uygun. / Compatible with ISO Insert. Kompatibel mit ISO Wendepplatten.

Sipariş Örneği/Ordering Example/Bestellbeispiel

1 ad./pcs./stück ACBM-CC06-D17X6-W16-L150-Z02

Kesme Hesabı : S 331 / Cutting Calculation : P 331 / Schnittberechnung : 331



S-SİSTEM YÜZEY PARMAK FREZELER

S-SYSTEM END MILLS

S-SYSTEM SCHAFTFRÄSER

KAPR=90°

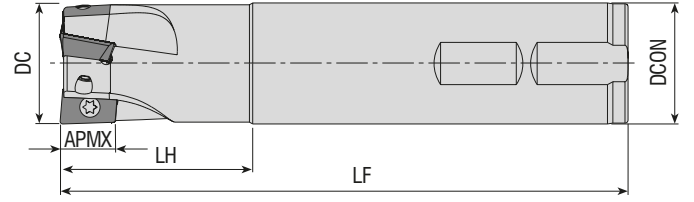

Takım Kodu
Ordering Code
Bestell-Bezeichnung

Stok
Stock
Lager

Takım Ölçüleri (mm)
Dimension (mm)
Abmessung (mm)

Kesici Uç
Insert
Wendeschneidplatte

Yedek Parçaları / Spare Parts / Ersatzteile

Sıkma Vidası
Screw
Schraube

Tork Anahtar
Torx Key
Torx-Schlüssel

Takım Kodu Ordering Code Bestell-Bezeichnung	Stok Stock Lager	DC	ZEFP	DCON	LF	LH	APMX	Kesici Uç Insert Wendeschneidplatte	Sıkma Vidası Screw Schraube	Tork Anahtar Torx Key Torx-Schlüssel
AEM90-AD1505-D25-W25-L150-Z02	●	25	2	25	150	50	15	AD.. 1505..	4015-M4x9	80-T15
AEM90-AD1505-D30-W25-L150-Z03	●	30	3	25	150	40	15			
AEM90-AD1505-D32-W32-L150-Z03	●	32	3	32	150	50	15			

ISCR Ucuna Uygunudur. / Compatible with ISCR Insert. Kompatibel mit ISCR Wendepalten.

KAPR=90°

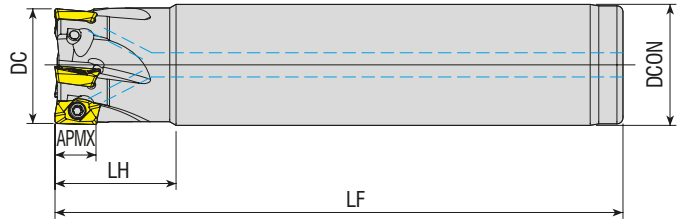

Takım Kodu
Ordering Code
Bestell-Bezeichnung

Stok
Stock
Lager

Takım Ölçüleri (mm)
Dimension (mm)
Abmessung (mm)

Kesici Uç
Insert
Wendeschneidplatte

Yedek Parçaları / Spare Parts / Ersatzteile

Sıkma Vidası
Screw
Schraube

Tork Anahtar
Torx Key
Torx-Schlüssel

Takım Kodu Ordering Code Bestell-Bezeichnung	Stok Stock Lager	DC	ZEFP	DCON	LF	LH	APMX	Kesici Uç Insert Wendeschneidplatte	Sıkma Vidası Screw Schraube	Tork Anahtar Torx Key Torx-Schlüssel
AEM90-AD07-D10-C08-L90-Z02-H	●	10	2	8	90	16	6	ADMX 0702..	3006-M2x3.3 3006-M2x3.1 3006-M2x3.3 3006-M2x3.6 3006-M2x4	80-T06
AEM90-AD07-D10-C10-L80-Z02-H	●	10	2	10	80	16	6			
AEM90-AD07-D12-C10-L80-Z03-H	●	12	3	10	80	18	6			
AEM90-AD07-D12-C12-L90-Z03-H	●	12	3	12	90	18	6			
AEM90-AD07-D16-C16-L110-Z04-H	●	16	4	16	110	19	6			
AEM90-AD07-D20-C20-L125-Z05-H	●	20	5	20	125	20	6			
AEM90-AD07-D25-C25-L140-Z06-H	●	25	6	25	140	24	6	ADMX 11T30..	3008-M2.5x5.5 3008-M2.5x6	80-T08
AEM90-AD11-D16-C16-L135-Z02-H	●	16	2	16	135	24	9			
AEM90-AD11-D18-C16-L135-Z02-H	●	18	2	16	135	15	9			
AEM90-AD11-D18-C16-L160-Z02-H	●	18	2	16	160	15	9			
AEM90-AD11-D20-C20-L150-Z02-H	●	20	2	20	150	50	9			
AEM90-AD11-D20-C20-L150-Z03-H	●	20	3	20	150	50	9			
AEM90-AD11-D22-C20-L150-Z03-H	●	22	3	20	150	15	9			
AEM90-AD11-D22-C20-L200-Z03-H	●	22	3	20	200	15	9			
AEM90-AD11-D25-C25-L170-Z03-H	●	25	3	25	170	50	9			
AEM90-AD11-D25-C25-L170-Z04-H	●	25	4	25	170	50	9			
AEM90-AD11-D28-C25-L165-Z04-H	●	28	4	25	165	17	9			
AEM90-AD11-D28-C25-L200-Z04-H	●	28	4	25	200	17	9			
AEM90-AD11-D30-C25-L165-Z04-H	●	30	4	25	165	19	9			
AEM90-AD11-D30-C25-L200-Z04-H	●	30	4	25	200	19	9			
AEM90-AD11-D32-C32-L195-Z05-H	●	32	5	32	195	50	9			

R: Sağ / Right / Rechts L: Sol/Left/Links

● Stokta / In Stock / Auf Lager ○ Stokta Yok / Non Stock Item / Kein Lagerartikel, Lieferzeit auf Anfrage

PRMT Ucuna Uygunudur. / Compatible with PRMT Insert. Kompatibel mit PRMT Wendepalten.

Sipariş Örneği/Ordering Example/Bestellbeispiel

1 ad./pcs./stück AEM90-AD1505-D25-W25-L150-Z02

Kesme Hesabı : S 331 / Cutting Calculation : P 331 / Schnittberechnung : 331



www.akkо.com.tr

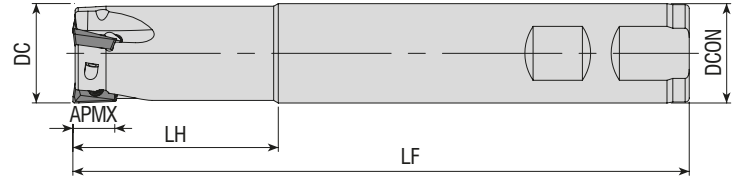

Takım Kodu Ordering Code Bestell-Bezeichnung	Stok Stock Lager	Takım Ölçüleri (mm) Dimension (mm) Abmessung (mm)						Kesici Uç Insert Wendeschneidplatte	Yedek Parçaları / Spare Parts / Ersatzteile		
		DC	ZEFP	DCON	LF	LH	APMX		Sıkma Vidası Screw Schraube	Tork Anahtar Torx Key Torx-Schlüssel	
AEM90-AD0803-D16-W16-L150-Z02	●	16	2	16	150	30	8	ADMT 0803..	3008-M2.5x5		
AEM90-AD0803-D17-W16-L150-Z02	●	17	2	16	150	30	8				
AEM90-AD0803-D17-W16-L200-Z02	●	17	2	16	200	30	8				
AEM90-AD0803-D20-W20-L150-Z03	●	20	3	20	150	30	8				
AEM90-AD0803-D21-W20-L200-Z03	●	21	3	20	200	30	8				
AEM90-AD10T3-D16-W16-L100-Z02-H	●	16	2	16	100	30	10	ADMT 10T3..	3008-M2.5x5	80-T08	
AEM90-AD10T3-D16-W16-L150-Z02	●	16	2	16	150	40	10				
AEM90-AD10T3-D16-C16-L200-Z02	●	16	2	16	200	50	10				
AEM90-AD10T3-D17-W16-L150-Z02	●	17	2	16	150	30	10				
AEM90-AD10T3-D17-W16-L200-Z02	●	17	2	16	200	30	10				
AEM90-AD10T3-D20-W20-L70-Z03	●	20	3	20	70	30	10				
AEM90-AD10T3-D20-W20-L100-Z03-H	●	20	3	20	100	30	10				
AEM90-AD10T3-D20-W20-L150-Z03	●	20	3	20	150	40	10				
AEM90-AD10T3-D20-C20-L150-Z03	●	20	3	20	150	40	10				
AEM90-AD10T3-D20-C20-L200-Z03	●	20	3	20	200	50	10				
AEM90-AD10T3-D25-W25-L100-Z03-H	●	25	3	25	100	30	10				
AEM90-AD10T3-D25-W25-L100-Z04-H	●	25	4	25	100	30	10				
AEM90-AD10T3-D25-W25-L150-Z03	●	25	3	25	150	50	10				
AEM90-AD1204-D20-W20-L150-Z02	●	20	2	20	150	50	12	ADMT 1204..	4010-M3x6	80-T10	
AEM90-AD1204-D21-C20-L150-Z02	●	21	2	20	150	30	12				
AEM90-AD1204-D22-C20-L150-Z02	●	22	2	20	150	30	12				
AEM90-AD1204-D25-W25-L150-Z03	●	25	3	25	150	50	12				
AEM90-AD1204-D26-W25-L180-Z03	●	26	3	25	180	30	12				
AEM90-AD1204-D32-W32-L150-Z04	●	32	4	32	150	50	12	ADMT 1606..	4015-M4x9	80-T15	
AEM90-AD1606-D25-W25-L150-Z02	●	25	2	25	150	50	15				
AEM90-AD1606-D32-W32-L150-Z03	●	32	3	32	150	50	15				

R: Sağ / Right / Rechts L: Sol/Left/Links

● Stokta / In Stock / Auf Lager ○ Stokta Yok / Non Stock Item / Kein Lagerartikel, Lieferzeit auf Anfrage
WLTR Ucuna Uygunudur. / Compatible with WLTR Insert. Kompatibel mit WLTR Wendeplatten.

Sipariş Örneği/Ordering Example/Bestellbeispiel

1 ad./pcs./stück AEM90-AD0803-D16-W16-L150-Z02

Kesme Hesabı : S 331 / Cutting Calculation : P 331 / Schnittberechnung : 331

S-SİSTEM YÜZEY PARMAK FREZELER

S-SYSTEM END MILLS

S-SYSTEM SCHAFTFRÄSER

KAPR=90°

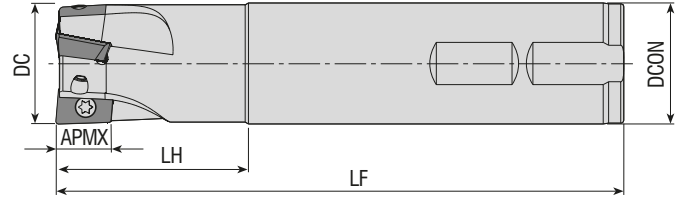

Takım Kodu
Ordering Code
Bestell-Bezeichnung

Stok
Stock
Lager

Takım Ölçüleri (mm)
Dimension (mm)
Abmessung (mm)

Kesici Uç
Insert
Wendeschneidplatte

Yedek Parçaları / Spare Parts / Ersatzteile

Sıkma Vidası
Screw
Schraube

Tork Anahtar
Torx Key
Torx-Schlüssel

Takım Kodu Ordering Code Bestell-Bezeichnung	Stok Stock Lager	DC	ZAFP	DCON	LF	LH	APMX	Kesici Uç Insert Wendeschneidplatte	Sıkma Vidası Screw Schraube	Tork Anahtar Torx Key Torx-Schlüssel
AEM90-AD1003-D16-C16-L150-Z02	●	16	2	16	150	30	8	ADMT 1003..	3008-M2.5x5	80-T08
AEM90-AD1003-D17-C16-L150-Z02	●	17	2	16	150	25	8			
AEM90-AD1003-D20-C20-L200-Z03	●	20	3	20	200	50	8			
AEM90-AD1003-D21-C20-L150-Z03	●	21	3	20	150	25	8			
AEM90-AD1003-D21-C20-L200-Z03	●	21	3	20	200	25	8			
AEM90-AD1003-D25-C25-L200-Z03	●	25	3	25	200	50	8			
AEM90-AD1003-D26-C25-L150-Z03	●	26	3	25	150	30	8			
AEM90-AD1003-D26-C25-L200-Z03	●	26	3	25	200	30	8			
AEM90-AD1505D-D25-W25-L150-Z02	●	25	2	25	150	50	14.3	ADKT 150508	4015-M4x9	80-T15
AEM90-AD1505D-D32-W32-L150-Z03	●	32	3	32	150	50	14.3		4015-M4x11	

DJT Ucuna Uygun. / Compatible with DJT Insert. Kompatibel mit DJT Wendeplatten.

KAPR=90°

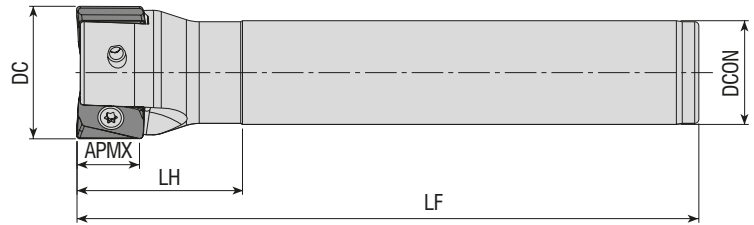

Takım Kodu
Ordering Code
Bestell-Bezeichnung

Stok
Stock
Lager

Takım Ölçüleri (mm)
Dimension (mm)
Abmessung (mm)

Kesici Uç
Insert
Wendeschneidplatte

Yedek Parçaları / Spare Parts / Ersatzteile

Sıkma Vidası
Screw
Schraube

Tork Anahtar
Torx Key
Torx-Schlüssel

Takım Kodu Ordering Code Bestell-Bezeichnung	Stok Stock Lager	DC	ZAFP	DCON	LF	LH	APMX	Kesici Uç Insert Wendeschneidplatte	Sıkma Vidası Screw Schraube	Tork Anahtar Torx Key Torx-Schlüssel
AEM90-AN11-D22-W20-L150-Z02	●	22	2	20	150	30	11	ANGX 110508	4010-M3x8	80-T10
AEM90-AN11-D25-W25-L150-Z02	●	25	2	25	150	40	11			
AEM90-AN11-D25-C25-L200-Z02	●	25	2	25	200	40	11			
AEM90-AN11-D26-W25-L150-Z02	●	26	2	25	150	40	11			
AEM90-AN11-D28-W25-L150-Z02	●	28	2	25	150	25	11			
AEM90-AN11-D32-W32-L150-Z03	●	32	3	32	150	50	11			
AEM90-AN11-D32-C32-L200-Z03	●	32	3	32	200	50	11			
AEM90-AN11-D40-W32-L150-Z04	●	40	4	32	150	40	11			

R: Sağ / Right / Rechts L: Sol/Left/Links

● Stokta / In Stock / Auf Lager ○ Stokta Yok / Non Stock Item / Kein Lagerartikel, Lieferzeit auf Anfrage
ZCC Ucuna Uygun. / Compatible with ZCC Insert. Kompatibel mit ZCC Wendeplatten.

Sipariş Örneği/Ordering Example/Bestellbeispiel

1 ad./pcs./stück AEM90-AD1003-D16-C16-L150-Z02

Kesme Hesabı : S 331 / Cutting Calculation : P 331 / Schnittberechnung : 331



www.akko.com.tr

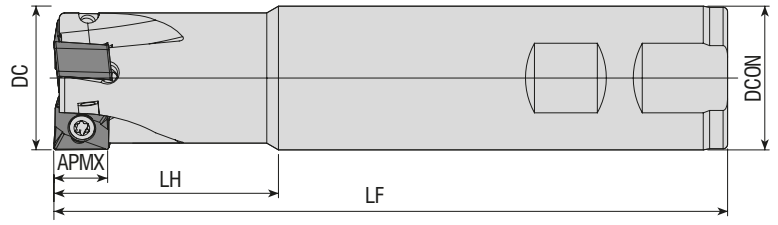

Takım Kodu Ordering Code Bestell-Bezeichnung	Stok Stock Lager	Takım Ölçüleri (mm) Dimension (mm) Abmessung (mm)						Kesici Uç Insert Wendeschneidplatte	Yedek Parçaları / Spare Parts / Ersatzteile		
		DC	ZEFP	DCON	LF	LH	APMX		Sıkma Vidası Screw Schraube	Tork Anahtar Torx Key Torx-Schlüssel	
AEM90-AN1207-D25-W25-L150-Z02	●	25	2	25	150	40	10	ANKX 1207..	4015-M4x11	80-T15	
AEM90-AN1207-D32-W32-L150-Z03	●	32	3	32	150	50	10				
AEM90-AN1207-D40-W32-L150-Z04	●	40	4	32	150	40	10				

XTC-GSC Ucuna Uygunudur. / Compatiple with XTC-GSC Insert. Kompatibel mit XTC-GSC Wendepalten.

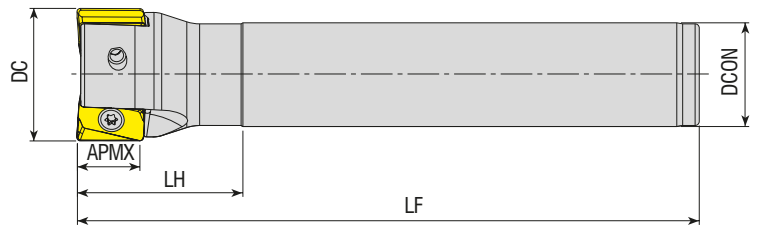

Takım Kodu Ordering Code Bestell-Bezeichnung	Stok Stock Lager	Takım Ölçüleri (mm) Dimension (mm) Abmessung (mm)						Kesici Uç Insert Wendeschneidplatte	Yedek Parçaları / Spare Parts / Ersatzteile		
		DC	ZEFP	DCON	LF	LH	APMX		Sıkma Vidası Screw Schraube	Tork Anahtar Torx Key Torx-Schlüssel	
AEM90-AN1607-D32-C25-L150-Z02	●	32	2	25	150	50	15	AN.X 1607	4015-M4x11	80-T15	
AEM90-AN1607-D40-C32-L150-Z03	●	40	3	32	150	50	15				

R: Sağ / Right / Rechts L: Sol/Left/Links

● Stokta / In Stock / Auf Lager ○ Stokta Yok / Non Stock Item / Kein Lagerartikel, Lieferzeit auf Anfrage
TGTC Ucuna Uygunudur. / Compatiple with TGTC Insert. Kompatibel mit TGTC Wendepalten.

Sipariş Örneği/Ordering Example/Bestellbeispiel
1 ad./pcs./stück AEM90-AN1207-D25-W25-L150-Z02
Kesme Hesabı : S 331 / Cutting Calculation : P 331 / Schnittberechnung : 331

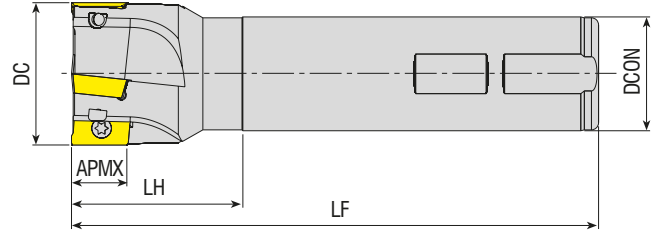

Takım Kodu Ordering Code Bestell-Bezeichnung	Stok Stock Lager	Takım Ölçüleri (mm) Dimension (mm) Abmessung (mm)						Kesici Uç Insert Wendeschneidplatte	Yedek Parçaları / Spare Parts / Ersatzteile	
		DC	ZEFP	DCON	LF	LH	APMX		Sıkma Vidası Screw Schraube	Tork Anahtar Torx Key Torx-Schlüssel
AEM90-AP06-D10-C10-L120-Z02	●	10	2	10	120	20	5.6	APMT 0602.. KRLY UCUNA UYGUNDUR. FOR KRLY INSERT. Für KRLY	3006-M1.8x4	80-T06
AEM90-AP06-D12-C12-L120-Z02	●	12	2	12	120	20	5.6			
AEM90-AP0903-D16-C16-L150-Z02	●	16	2	16	150	30	9	APMT 0903.. KRLY UCUNA UYGUNDUR. FOR KRLY INSERT.	3008-M2.5x5	80-T08
AEM90-AP0903-D17-C16-L150-Z02	●	17	2	16	150	30	9			
AEM90-AP0903-D20-C20-L150-Z02	●	20	2	20	150	30	9	TGTC UCUNA UYGUNDUR. FOR TGTC INSERT. Kompatibel mit Wendeschneidplatte: TGTC	3008-M2.5x6	80-T08
AEM90-AP0903-D21-C20-L150-Z02	●	21	2	20	150	30	9			
AEM90-AP0903-D25-C25-L150-Z03	●	25	3	25	150	30	9	APKT 09T3.. TGTC UCUNA UYGUNDUR. FOR TGTC INSERT.	3008-M2.5x6	80-T08
AEM90-AP09-D16-C16-L100-Z02-H	●	16	2	16	100	30	8.8			
AEM90-AP09-D16-C15-L150-Z02	●	16	2	15	150	25	8.8	AP. 1003.. ISO UCUNA UYGUNDUR. FOR ISO INSERT. Kompatibel mit Wendeschneidplatte: ISO	3008-M2.5x5	80-T08
AEM90-AP09-D16-W16-L150-Z02-H	●	16	2	16	150	25	8.8			
AEM90-AP09-D16-C16-L200-Z02-H	●	16	2	16	200	100	8.8	AP. 1003.. ISO UCUNA UYGUNDUR. FOR ISO INSERT.	3008-M2.5x5	80-T08
AEM90-AP09-D17-C16-L150-Z02	●	17	2	16	150	25	8.8			
AEM90-AP09-D17-C16-L180-Z02-H	●	17	2	16	180	25	8.8	AP. 1003.. ISO UCUNA UYGUNDUR. FOR ISO INSERT.	3008-M2.5x5	80-T08
AEM90-AP09-D20-C20-L150-Z03-H	●	20	3	20	150	50	8.8			
AEM90-AP09-D20-C20-L200-Z03-H	●	20	3	20	200	100	8.8	AP. 1003.. ISO UCUNA UYGUNDUR. FOR ISO INSERT.	3008-M2.5x5	80-T08
AEM90-AP09-D20-C20-L250-Z02-H	●	20	2	20	250	150	8.8			
AEM90-AP09-D21-C20-L150-Z03	●	21	3	20	150	25	8.8	AP. 1003.. ISO UCUNA UYGUNDUR. FOR ISO INSERT.	3008-M2.5x5	80-T08
AEM90-AP09-D26-C25-L150-Z04	●	26	4	25	150	30	8.8			
AEM90-AP10-D12-W16-L100-Z01-H	●	12	1	16	100	30	10	AP. 1003.. ISO UCUNA UYGUNDUR. FOR ISO INSERT.	3008-M2.5x5	80-T08
AEM90-AP10-D12-W16-L150-Z01	●	12	1	16	150	38	10			
AEM90-AP10-D14-W16-L100-Z01-H	●	14	1	16	100	30	10	AP. 1003.. ISO UCUNA UYGUNDUR. FOR ISO INSERT.	3008-M2.5x5	80-T08

R: Sağ / Right / Rechts L: Sol/Left/Links

● Stokta / In Stock / Auf Lager ○ Stokta Yok / Non Stock Item / Kein Lagerartikel, Lieferzeit auf Anfrage



Sipariş Örneği/Ordering Example/Bestellbeispiel

1 ad./pcs./stück AEM90-AP06-D10-C10-L120-Z02

Kesme Hesabı : S 331 / Cutting Calculation : P 331 / Schnittberechnung : 331

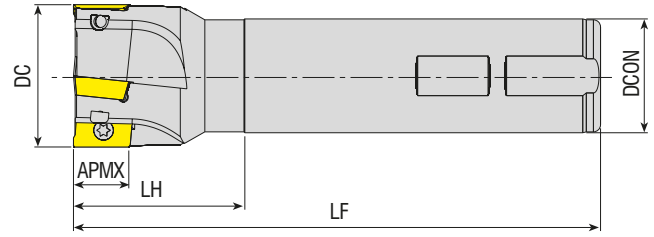
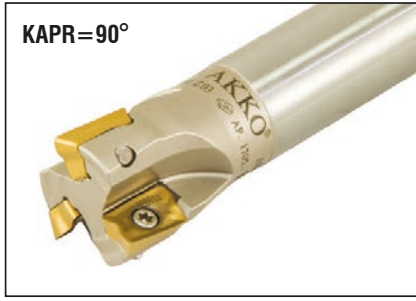



Takım Kodu Ordering Code Bestell-Bezeichnung	Stok Stock Lager	Takım Ölçüleri (mm) Dimension (mm) Abmessung (mm)						Kesici Uç Insert Wendeschneidplatte	Yedek Parçaları / Spare Parts / Ersatzteile	
		DC	ZEPF	DCON	LF	LH	APMX		Sıkma Vidası Screw Schraube	Tork Anahtar Torx Key Torx-Schlüssel
AEM90-AP10-D14-W16-L150-Z01	●	14	1	16	150	38	10	 AP. 1003.. ISO UCUNA UYGUNDUR. FOR ISO INSERT. <i>Kompatibel mit Wendeschneidplatte ISO</i>	 3008-M2.5x5	
AEM90-AP10-D16-C16-L100-Z02-H	●	16	2	16	100	30	10			
AEM90-AP10-D16-W16-L100-Z02-H	●	16	2	16	100	30	10			
AEM90-AP10-D16-C16-L120-Z02-H	●	16	2	16	120	30	10			
AEM90-AP10-D16-C16-L150-Z02	●	16	2	16	150	50	10			
AEM90-AP10-D16-C16-L150-Z02-H	●	16	2	16	150	50	10			
AEM90-AP10-D16-W16-L150-Z02	●	16	2	16	150	50	10			
AEM90-AP10-D16-C16-L200-Z02	●	16	2	16	200	100	10			
AEM90-AP10-D16-C16-L200-Z02-H	●	16	2	16	200	100	10			
AEM90-AP10-D16-C16-L250-Z02	●	16	2	16	250	50	10			
AEM90-AP10-D18-W16-L100-Z02-H	●	18	2	16	100	30	10			
AEM90-AP10-D18-W16-L150-Z02	●	18	2	16	150	30	10			
AEM90-AP10-D20-C20-L100-Z03-H	●	20	3	20	100	30	10			
AEM90-AP10-D20-W20-L100-Z03-H	●	20	3	20	100	30	10			
AEM90-AP10-D20-C20-L120-Z03-H	●	20	3	20	120	30	10			
AEM90-AP10-D20-C20-L150-Z03	●	20	3	20	150	50	10			
AEM90-AP10-D20-C20-L150-Z03-H	●	20	3	20	150	50	10			
AEM90-AP10-D20-W20-L150-Z03	●	20	3	20	150	50	10			
AEM90-AP10-D20-C20-L200-Z02	●	20	2	20	200	100	10			
AEM90-AP10-D20-C20-L200-Z03-H	●	20	3	20	200	100	10			
AEM90-AP10-D20-C20-L250-Z02	●	20	2	20	250	150	10			
AEM90-AP10-D20-C20-L250-Z02-H	●	20	2	20	250	150	10			
AEM90-AP10-D21-W20-L150-Z03	●	21	3	20	150	30	10			
AEM90-AP10-D22-W20-L100-Z03-H	●	22	3	20	100	30	10			
AEM90-AP10-D22-W20-L150-Z03	●	22	3	20	150	30	10			
AEM90-AP10-D23-W20-L150-Z03	●	23	3	20	150	30	10			
AEM90-AP10-D24-W20-L150-Z03	●	24	3	20	150	30	10			
AEM90-AP10-D25-W25-L100-Z04-H	●	25	4	25	100	30	10			
AEM90-AP10-D25-C25-L100-Z03-H	●	25	3	25	100	30	10			
AEM90-AP10-D25-W25-L100-Z03-H	●	25	3	25	100	30	10			
AEM90-AP10-D25-C25-L120-Z03-H	●	25	3	25	120	30	10			
AEM90-AP10-D25-C25-L150-Z03	●	25	3	25	150	50	10			
AEM90-AP10-D25-W25-L150-Z03	●	25	3	25	150	50	10			
AEM90-AP10-D25-C25-L200-Z02	●	25	2	25	200	100	10			
AEM90-AP10-D25-C25-L200-Z03	●	25	3	25	200	100	10			
AEM90-AP10-D25-C25-L250-Z02	●	25	2	25	250	100	10			

R: Sağ / Right / Rechts L: Sol/Left/Links

● Stokta / In Stock / Auf Lager ○ Stokta Yok / Non Stock Item / Kein Lagerartikel, Lieferzeit auf Anfrage

Sipariş Örneği/Ordering Example/Bestellbeispiel

1 ad./pcs./stück AEM90-AP10-D14-W16-L150-Z01

Kesme Hesabı : S 331 / Cutting Calculation : P 331 / Schnittberechnung : 331

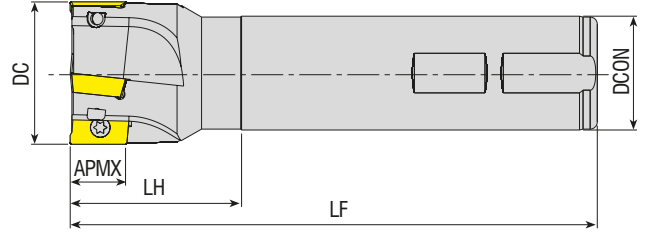
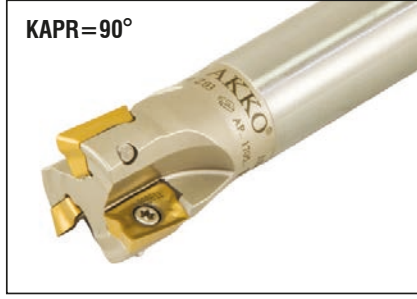

Takım Kodu Ordering Code Bestell-Bezeichnung	Stok Stock Lager	Takım Ölçüleri (mm) Dimension (mm) Abmessung (mm)						Kesici Uç Insert Wendeschneidplatte	Yedek Parçaları / Spare Parts / Ersatzteile	
		DC	ZEPF	DCON	LF	LH	APMX		Sıkma Vidası Screw Schraube	Tork Anahtar Torx Key Torx-Schlüssel
AEM90-AP10-D30-C25-L100-Z04-H	●	30	4	25	100	30	10	AP. 1003.. ISO UCUNA UYGUNDUR. FOR ISO INSERT. Kompatibel mit Wendeschneidplatte ISO	3008-M2.5x6	
AEM90-AP10-D30-C25-L120-Z04-H	●	30	4	25	120	30	10			
AEM90-AP10-D30-C25-L150-Z04	●	30	4	25	150	30	10			
AEM90-AP10-D32-C25-L100-Z04-H	●	32	4	25	100	35	10			
AEM90-AP10-D32-C25-L120-Z04-H	●	32	4	25	120	35	10			
AEM90-AP10-D32-C25-L150-Z04	●	32	4	25	150	35	10			
AEM90-AP10-D32-W25-L150-Z04	●	32	4	25	150	35	10			
AEM90-AP10-D32-C32-L130-Z05	●	32	5	32	130	30	10			
AEM90-AP10-D32-W32-L150-Z04	●	32	4	32	150	50	10			
AEM90-AP10-D40-W32-L150-Z05	●	40	5	32	150	40	10			
AEM90-AP10D-D16-W16-L150-Z02	●	16	2	16	150	50	10	AP. 1003.. DJT UCUNA UYGUNDUR. FOR DJT INSERT) Für DJT	3008-M2.5x5	80-T08
AEM90-AP10D-D20-W20-L150-Z03	●	20	3	20	150	50	10			
AEM90-AP10D-D25-W20-L150-Z03	●	25	3	20	150	30	10			
AEM90-AP100-D16-C15-L150-Z02	●	16	2	15	150	30	10			
AEM90-AP100-D21-C20-L150-Z03	●	21	3	20	150	30	10			
AEM90-AP100-D26-C25-L150-Z04	●	26	4	25	150	35	10			
AEM90-AP100-D33-C32-L200-Z05	●	33	5	32	200	50	10			
AEM90-AP10S-D16-W16-L150-Z02	●	16	2	16	150	26	10			
AEM90-AP10S-D20-W20-L150-Z02	●	20	2	20	150	26	10			
AEM90-AP10S-D25-W25-L150-Z03	●	25	3	25	150	26	10			
AEM90-AP11-D16-C16-L150-Z02	●	16	2	16	150	50	11	AP. 11T3.. ZCC UCUNA UYGUNDUR. FOR ZCC INSERT. Kompatibel mit Wendeschneidplatte ZCC	3008-M2.5x6	
AEM90-AP11-D16-C16-L150-Z02-H	●	16	2	16	150	50	11			
AEM90-AP11-D16-W16-L150-Z02	●	16	2	16	150	50	11			
AEM90-AP11-D16-W16-L150-Z02-H	●	16	2	16	150	50	11			
AEM90-AP11-D16-C16-L200-Z02	●	16	2	16	200	100	11			
AEM90-AP11-D17-C16-L150-Z02	●	17	2	16	150	30	11			
AEM90-AP11-D17-C16-L200-Z02	●	17	2	16	200	30	11			
AEM90-AP11-D20-C20-L150-Z03	●	20	3	20	150	50	11			
AEM90-AP11-D20-W20-L150-Z03	●	20	3	20	150	50	11			
AEM90-AP11-D20-W20-L150-Z03-H	●	20	3	20	150	50	11			
AEM90-AP11-D20-C20-L200-Z03	●	20	3	20	200	100	11			
AEM90-AP11-D21-C20-L150-Z03	●	21	3	20	150	30	11			
AEM90-AP11-D21-W20-L150-Z03	●	21	3	20	150	30	11			
AEM90-AP11-D21-W20-L150-Z03-H	●	21	3	20	150	30	11			
AEM90-AP11-D21-C20-L200-Z03	●	21	3	20	200	30	11			
AEM90-AP11-D25-C25-L150-Z03	●	25	3	25	150	50	11			
AEM90-AP11-D25-W25-L150-Z03	●	25	3	25	150	50	11			
AEM90-AP11-D25-W25-L150-Z03-H	●	25	3	25	150	50	11			
AEM90-AP11-D26-C25-L150-Z03	●	26	3	25	150	35	11			
AEM90-AP11-D26-C24-L150-Z03	●	26	3	24	150	47	11			
AEM90-AP11-D32-W25-L150-Z04	●	32	4	25	150	35	11			
AEM90-AP11-D32-W32-L150-Z03-H	●	32	3	32	150	50	11			
AEM90-AP11-D32-W32-L150-Z04	●	32	4	32	150	50	11			

R: Sağ / Right / Rechts L: Sol/Left/Links / ● Stokta / In Stock / Auf Lager ○ Stokta Yok / Non Stock Item / Kein Lagerartikel, Lieferzeit auf Anfrage

Sipariş Örneği/Ordering Example/Bestellbeispiel

1 ad./pcs./stück AEM90-AP10-D30-C25-L100-Z04-H

Kesme Hesabı : S 331 / Cutting Calculation : P 331 / Schnittberechnung : 331

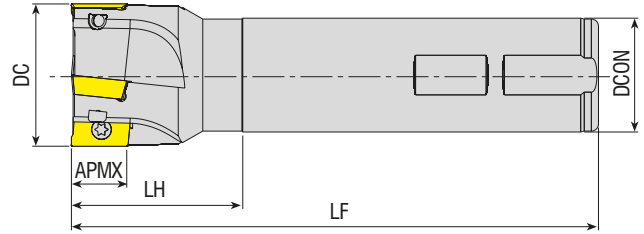
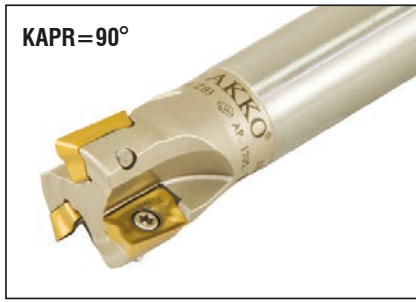

Takım Kodu Ordering Code Bestell-Bezeichnung	Stok Stock Lager	Takım Ölçüleri (mm) Dimension (mm) Abmessung (mm)						Kesici Uç Insert Wendeschneidplatte	Yedek Parçaları / Spare Parts / Ersatzteile		
		DC	ZEFP	DCON	LF	LH	APMX		Sıkma Vidası Screw Schraube	Tork Anahtar Torx Key Torx-Schlüssel	
AEM90-AP1135A-D14-C16-L150-Z01	●	14	1	16	150	40	9.5	APMT 1135.. ACHTK UCUNA UYGUNDUR. FOR ACHTK INSERT. <i>Kompatibel mit Wendeschneidplatte: ACHTK</i>	3008-M2.5x5		
AEM90-AP1135A-D16-C16-L150-Z02	●	16	2	16	150	40	9.5				
AEM90-AP1135A-D16-C16-L200-Z02	●	16	2	16	200	100	9.5				
AEM90-AP1135A-D16-C16-L250-Z02	●	16	2	16	250	150	9.5				
AEM90-AP1135A-D17-C16-L180-Z02	●	17	2	16	180	30	9.5				
AEM90-AP1135A-D20-C20-L150-Z03	●	20	3	20	150	50	9.5		3008-M2.5x6		
AEM90-AP1135A-D20-C20-L200-Z02	●	20	2	20	200	100	9.5				
AEM90-AP1135A-D21-C20-L180-Z02	●	21	2	20	180	30	9.5				
AEM90-AP1135A-D25-C25-L200-Z03	●	25	3	25	200	100	9.5				
AEM90-AP1135A-D26-C25-L250-Z02	●	26	2	25	250	35	9.5				
AEM90-AP1135A-D33-C32-L250-Z02	●	33	2	32	250	35	9.5	AP. 1135.. B.OKE UCUNA UYGUNDUR. FOR B.OKE INSERT <i>Kompatibel mit Wendeschneidplatte: B.OKE</i>	80-T08		
AEM90-AP110-D16-C15-L150-Z02	●	16	2	15	150	30	11				
AEM90-AP110-D21-C20-L150-Z03	●	21	3	20	150	30	11				
AEM90-AP110-D26-C25-L150-Z04	●	26	4	25	150	35	11				
AEM90-AP110-D33-C32-L200-Z05	●	33	5	32	200	50	11				
AEM90-APK11G-D16-W16-L150-Z02	●	16	2	16	150	26	11			3008-M3x5	
AEM90-APK11G-D20-W20-L150-Z03	●	20	3	20	150	26	11				
AEM90-APK11G-D25-W25-L150-Z03	●	25	3	25	150	26	11				
AEM90-AP1135-D16-W16-L110-Z02-H	●	16	2	16	110	30	9.5			AP. 1135.. XTC-GSC UCUNA UYGUNDUR. FOR XTC-GSC INSERT. <i>Kompatibel mit Wendeschneidplatte: XTC-GSC</i>	3008-M2.5x6
AEM90-AP1135-D16-W16-L150-Z02	●	16	2	16	150	50	9.5				
AEM90-AP1135-D20-W20-L125-Z03-H	●	20	3	20	125	30	9.5				
AEM90-AP1135-D20-W20-L150-Z03	●	20	3	20	150	50	9.5				
AEM90-AP1135-D25-W25-L125-Z04-H	●	25	4	25	125	30	9.5				
AEM90-AP1135-D25-W25-L200-Z04-H	●	25	4	25	200	100	9.5				
AEM90-AP1135-D32-W32-L125-Z05-H	●	32	5	32	125	30	9.5				
AEM90-AP1135-D32-W32-L200-Z04-H	●	32	4	32	200	100	9.5				
AEM90-AP1135Y-D16-W16-L150-Z02	●	16	2	16	150	50	9.5	APMT 1135.. YG UCUNA UYGUNDUR. FOR YG INSERT. <i>Kompatibel mit Wendeschneidplatte: YG</i>			
AEM90-AP1135Y-D20-W20-L150-Z03	●	20	3	20	150	50	9.5				
AEM90-AP1135Y-D25-W25-L150-Z03	●	25	3	25	150	50	9.5				
AEM90-AP1204-D20-C20-L150-Z02	●	20	2	20	150	30	12	AP. 1204.. TGTC UCUNA UYGUNDUR. FOR TGTC INSERT. <i>Kompatibel mit Wendeschneidplatte: TGTC</i>	80-T10		
AEM90-AP1204-D21-C20-L150-Z02	●	21	2	20	150	30	12				
AEM90-AP1204-D21-C20-L200-Z02	●	21	2	20	200	30	12				
AEM90-AP1204-D25-C25-L150-Z03	●	25	3	25	150	40	12				
AEM90-AP1204-D26-C25-L250-Z02	●	26	2	25	250	35	12				
AEM90-AP1204-D32-C25-L150-Z03	●	32	3	25	150	35	12	AP. 1604.. ISO UCUNA UYGUNDUR. FOR ISO INSERT. <i>Kompatibel mit Wendeschneidplatte: ISO</i>	80-T15		
AEM90-AP16-D25-C20-L100-Z02	●	25	2	20	100	35	16				
AEM90-AP16-D25-W25-L100-Z02-H	●	25	2	25	100	35	16				
AEM90-AP16-D25-W25-L150-Z02	●	25	2	25	150	50	16				
AEM90-AP16-D25-C25-L250-Z02	●	25	2	25	250	100	16				
AEM90-AP16-D28-W25-L100-Z03-H	●	28	3	25	100	40	16				

R: Sağ / Right / Rechts L: Sol/Left/Links

● Stokta / In Stock / Auf Lager ○ Stokta Yok / Non Stock Item / Kein Lagerartikel, Lieferzeit auf Anfrage

Sipariş Örneği/Ordering Example/Bestellbeispiel

1 ad./pcs./stück AEM90-AP1135A-D14-C16-L150-Z01

Kesme Hesabı : S 331 / Cutting Calculation : P 331 / Schnittberechnung : 331

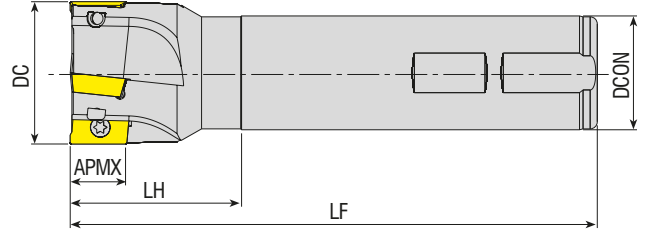
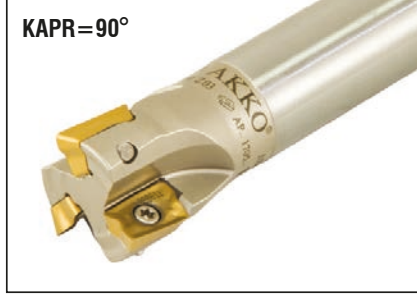

Takım Kodu Ordering Code Bestell-Bezeichnung	Stok Stock Lager	Takım Ölçüleri (mm) Dimension (mm) Abmessung (mm)						Kesici Uç Insert Wendeschneidplatte	Yedek Parçaları / Spare Parts / Ersatzteile	
		DC	ZEFP	DCON	LF	LH	APMX		Sıkma Vidası Screw Schraube	Tork Anahtar Torx Key Torx-Schlüssel
AEM90-AP16-D28-W25-L150-Z03	●	28	3	25	150	40	16	AP. 1604.. ISO UCUNA UYGUNDUR. FOR ISO INSERT Kompatibel mit Wendeschneidplatte ISO	4015-M4x9	
AEM90-AP16-D30-W25-L110-Z03-H	●	30	3	25	110	40	16			
AEM90-AP16-D30-W25-L150-Z02	●	30	2	25	150	40	16			
AEM90-AP16-D30-W25-L150-Z03	●	30	3	25	150	40	16			
AEM90-AP16-D32-W32-L110-Z03-H	●	32	3	32	110	40	16			
AEM90-AP16-D32-C32-L150-Z03	●	32	3	32	150	50	16			
AEM90-AP16-D32-W25-L150-Z03	●	32	3	25	150	40	16			
AEM90-AP16-D32-W32-L150-Z03	●	32	3	32	150	50	16			
AEM90-AP16-D32-W32-L150-Z03-H	●	32	3	32	150	50	16			
AEM90-AP16-D32-C25-L200-Z03-H	●	32	3	25	200	40	16			
AEM90-AP16-D32-C32-L250-Z02	●	32	2	32	250	100	16			
AEM90-AP16-D32-C32-L250-Z03	●	32	3	32	250	100	16			
AEM90-AP16-D35-W32-L150-Z03	●	35	3	32	150	40	16			
AEM90-AP16-D36-W32-L110-Z03-H	●	36	3	32	110	40	16			
AEM90-AP16-D36-W32-L150-Z03	●	36	3	32	150	40	16			
AEM90-AP16-D40-W32-L110-Z04-H	●	40	4	32	110	40	16			
AEM90-AP16-D40-C32-L150-Z04	●	40	4	32	150	40	16			
AEM90-AP16-D40-W32-L150-Z04	●	40	4	32	150	40	16			
AEM90-AP16-D40-C32-L250-Z02	●	40	2	32	250	40	16			
AEM90-AP16-D40-C32-L250-Z04	●	40	4	32	250	40	16			
AEM90-AP16DJ-D25-W25-L150-Z02	●	25	2	25	150	50	16	AP. 1604.. DJT UCUNA UYGUNDUR. FOR DJT INSERT. Kompatibel mit Wendeschneidplatte DJT	80-T15	
AEM90-AP16DJ-D25-C25-L200-Z02	●	25	2	25	200	50	16			
AEM90-AP16DJ-D32-W32-L150-Z03	●	32	3	32	150	50	16			
AEM90-AP16DJ-D32-C32-L180-Z03	●	32	3	32	180	50	16			
AEM90-AP16DJ-D32-C32-L200-Z03	●	32	3	32	200	50	16			
AEM90-AP16L-D25-C25-L120-Z02-H	●	25	2	25	120	45	16	AP. 1604.. LMN UCUNA UYGUNDUR. FOR LMN INSERT. Kompatibel mit Wendeschneidplatte LMN	4015-M4x9	
AEM90-AP16L-D25-C25-L150-Z02	●	25	2	25	150	55	16			
AEM90-AP16L-D25-C25-L200-Z02	●	25	2	25	200	55	16			
AEM90-AP16L-D25-C25-L250-Z02	●	25	2	25	250	100	16			
AEM90-AP16L-D32-C32-L120-Z03-H	●	32	3	32	120	45	16			
AEM90-AP16L-D32-C32-L150-Z03	●	32	3	32	150	55	16			
AEM90-AP16L-D32-C32-L200-Z03	●	32	3	32	200	55	16			
AEM90-AP16L-D32-C32-L250-Z03	●	32	3	32	250	100	16			
AEM90-AP16L-D40-C32-L120-Z04-H	●	40	4	32	120	40	16			
AEM90-AP16L-D40-C32-L150-Z04	●	40	4	32	150	40	16			
AEM90-AP16L-D40-C32-L200-Z04	●	40	4	32	200	40	16			
AEM90-AP16L-D40-C32-L250-Z04	●	40	4	32	250	40	16			

R: Sağ / Right / Rechts L: Sol/Left/Links

● Stokta / In Stock / Auf Lager ○ Stokta Yok / Non Stock Item / Kein Lagerartikel, Lieferzeit auf Anfrage

Sipariş Örneği/Ordering Example/Bestellbeispiel

1 ad./pcs./stück AEM90-AP16-D28-W25-L150-Z03

Kesme Hesabı : S 331 / Cutting Calculation : P 331 / Schnittberechnung : 331

KAPR=90°

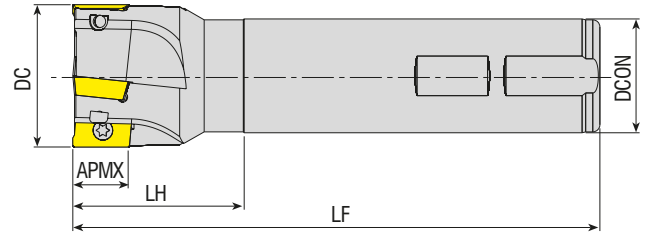
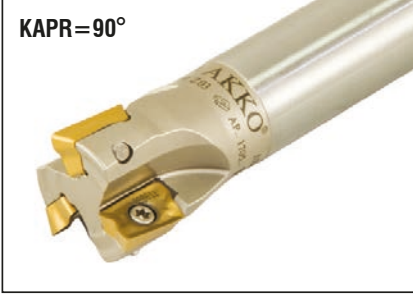

Takım Kodu Ordering Code Bestell-Bezeichnung	Stok Stock Lager	Takım Ölçüleri (mm) Dimension (mm) Abmessung (mm)						Kesici Uç Insert Wendeschneidplatte	Yedek Parçaları / Spare Parts / Ersatzteile	
		DC	ZEPF	DCON	LF	LH	APMX		Sıkma Vidası Screw Schraube	Tork Anahtar Torx Key Torx-Schlüssel
AEM90-AP16P-D25-W25-L100-Z02-H	●	25	2	25	100	35	16	AP.. 1604.. PLBT UCUNA UYGUNDUR. FOR PLBT INSERT. Kompatibel mit Wendeschneidplatte PLBT	 4015-M4x9	 80-T15
AEM90-AP16P-D25-W25-L150-Z02	●	25	2	25	150	50	16			
AEM90-AP16P-D32-W32-L150-Z03	●	32	3	32	150	50	16			
AEM90-AP16P-D32-C32-L250-Z02	●	32	2	32	250	100	16			
AEM90-AP16P-D40-W32-L150-Z04	●	40	4	32	150	50	16	AP.. 1705.. TGTC-LMN UCUNA UYGUNDUR. FOR TGTC-LMN INSERT. Kompatibel mit Wendeschneidplatte TGTC-LMN	 4015-M4x9	 80-T15
AEM90-AP1705-D25-C25-L120-Z02	●	25	2	25	120	40	16			
AEM90-AP1705-D26-C25-L200-Z02	●	26	2	25	200	40	16			
AEM90-AP1705-D26-C25-L250-Z02	●	26	2	25	250	40	16			
AEM90-AP1705-D26-C25-L300-Z02	○	26	2	25	300	40	16			
AEM90-AP1705-D28-W25-L075-Z02	●	28	2	25	75	20	16			
AEM90-AP1705-D32-C25-L150-Z03	●	32	3	25	150	40	16			
AEM90-AP1705-D33-C32-L250-Z03	●	33	3	32	250	40	16			
AEM90-AP1705-D33-C32-L300-Z02	●	33	2	32	300	40	16			

KAPR=90°

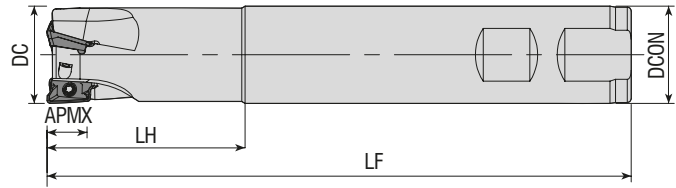

Takım Kodu Ordering Code Bestell-Bezeichnung	Stok Stock Lager	Takım Ölçüleri (mm) Dimension (mm) Abmessung (mm)						Kesici Uç Insert Wendeschneidplatte	Yedek Parçaları / Spare Parts / Ersatzteile	
		DC	ZEPF	DCON	LF	LH	APMX		Sıkma Vidası Screw Schraube	Tork Anahtar Torx Key Torx-Schlüssel
AEM90-A01236-D16-W16-L150-Z02	●	16	2	16	150	50	12	A0..1236..	 3008-M2.5x6	 80-T08
AEM90-A01236-D20-C20-L100-Z02	○	20	2	20	100	30	12			
AEM90-A01236-D25-C25-L115-Z02	○	25	2	25	150	50	12			
AEM90-A01236-D25-W25-L150-Z03	●	25	3	25	150	50	12			
AEM90-A01236-D32-W32-L150-Z04	●	32	4	32	150	50	12			

R: Sağ / Right / Rechts L: Sol/Left/Links

● Stokta / In Stock / Auf Lager ○ Stokta Yok / Non Stock Item / Kein Lagerartikel, Lieferzeit auf Anfrage
MTSBH Ucuna Uygunudur. / Compatiple with MTSBH Insert. Kompatibel mit MTSBH Wendepplatten.

Sipariş Örneği/Ordering Example/Bestellbeispiel

1 ad./pcs./stück AEM90-AP16-D25-W25-L100-Z02-H

Kesme Hesabı : S 331 / Cutting Calculation : P 331 / Schnittberechnung : 331

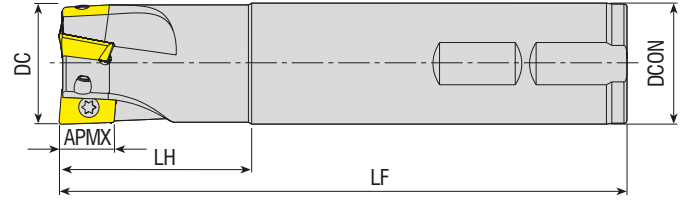

Takım Kodu Ordering Code Bestell-Bezeichnung	Stok Stock Lager	Takım Ölçüleri (mm) Dimension (mm) Abmessung (mm)						Kesici Uç Insert Wendeschneidplatte	Yedek Parçaları / Spare Parts / Ersatzteile				
		DC	ZEFP	DCON	LF	LH	APMX		Sıkma Vidası Screw Schraube	Tork Anahtar Torx Key Torx-Schlüssel			
AEM90-AX0602-D10-C09-L120-Z02	●	10	2	9	120	20	5.7	AX.. 0602	3006-M1.8x4	80-T06			
AEM90-AX0602-D10-C10-L080-Z02	●	10	2	10	80	20	5.7						
AEM90-AX0602-D10-C10-L120-Z02	●	10	2	10	120	20	5.7						
AEM90-AX0602-D12-C11-L120-Z02	●	12	2	11	120	20	5.7						
AEM90-AX0602-D12-C12-L080-Z02	●	12	2	12	80	20	5.7						
AEM90-AX0602-D12-C12-L120-Z02	●	12	2	12	120	20	5.7						
AEM90-AX0602-D14-C12-L120-Z03	●	14	3	12	120	20	5.7						
AEM90-AX0602-D16-W16-L120-Z04-H	●	16	4	16	120	20	5.7						
AEM90-AX0602-D16-W16-L150-Z04-H	●	16	4	16	150	20	5.7						
AEM90-AX0602-D20-W20-L120-Z05-H	●	20	5	20	120	25	5.7						
AEM90-AX0602-D20-W20-L150-Z05-H	●	20	5	20	150	25	5.7						
AEM90-AX0903-D16-C16-L120-Z02	●	16	2	16	120	30	8.8				AX.. 0903	3008-M2.5x5	80-T08
AEM90-AX0903-D16-C16-L180-Z02	●	16	2	16	180	30	8.8						
AEM90-AX0903-D17-C16-L120-Z02	●	17	2	16	120	25	8.8						
AEM90-AX0903-D17-C16-L180-Z02	●	17	2	16	180	25	8.8						
AEM90-AX0903-D20-C20-L120-Z03	●	20	3	20	120	30	8.8						
AEM90-AX0903-D20-C20-L200-Z02	●	20	2	20	200	30	8.8						
AEM90-AX0903-D21-C20-L120-Z03	●	21	3	20	120	25	8.8						
AEM90-AX0903-D21-C20-L200-Z02	●	21	2	20	200	25	8.8						
AEM90-AX0903-D25-C25-L150-Z03	●	25	3	25	150	30	8.8						
AEM90-AX0903-D25-C25-L250-Z02	●	25	2	25	250	40	8.8						
AEM90-AX0903-D26-C25-L150-Z03	●	26	3	25	150	30	8.8						

R: Sağ / Right / Rechts L: Sol/Left/Links

● Stokta / In Stock / Auf Lager ○ Stokta Yok / Non Stock Item / Kein Lagerartikel, Lieferzeit auf Anfrage
TGTC Ucuna Uygunudur. / Compatible with TGTC Insert. Kompatibel mit TGTC Wendepplatten.

Sipariş Örneği/Ordering Example/Bestellbeispiel

1 ad./pcs./stück AX0602-D10-C09-L120-Z02

Kesme Hesabı : S 331 / Cutting Calculation : P 331 / Schnittberechnung : 331



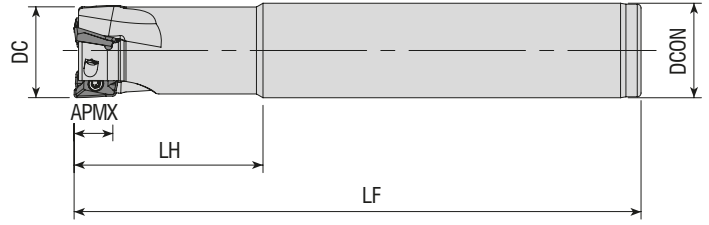

Takım Kodu Ordering Code Bestell-Bezeichnung	Stok Stock Lager	Takım Ölçüleri (mm) Dimension (mm) Abmessung (mm)						Kesici Uç Insert Wendeschneidplatte	Yedek Parçaları / Spare Parts / Ersatzteile			
		DC	ZEFP	DCON	LF	LH	APMX		Sıkma Vidası Screw Schraube	Tork Anahtar Torx Key Torx-Schlüssel		
AEM90-AX1235-D16-C14-L120-Z02-H	●	16	2	14	120	25	10	AX.T 1235..	3008-M3x6	80-T08		
AEM90-AX1235-D16-C15-L145-Z02-H	●	16	2	15	145	30	10		3108-M3x6			
AEM90-AX1235-D16-C16-L100-Z02-H	●	16	2	16	100	30	10		3008-M3x6			
AEM90-AX1235-D16-C16-L140-Z02-H	●	16	2	16	140	30	10		3108-M3x6			
AEM90-AX1235-D16-C16-L145-Z02-H	●	16	2	16	145	30	10		3008-M3x6			
AEM90-AX1235-D16-C16-L150-Z02	●	16	2	16	150	30	10		3108-M3x6			
AEM90-AX1235-D20-C19-L150-Z02-H	●	20	2	19	150	40	10		3008-M3x6			
AEM90-AX1235-D20-C20-L110-Z03-H	●	20	3	20	110	40	10		3108-M3x6			
AEM90-AX1235-D20-C20-L150-Z02	●	20	2	20	150	40	10		3008-M3x6			
AEM90-AX1235-D20-C20-L150-Z02-H	●	20	2	20	150	40	10		3108-M3x6			
AEM90-AX1235-D20-C20-L150-Z03	●	20	3	20	150	40	10		3008-M3x6			
AEM90-AX1235-D25-C20-L120-Z04-H	●	25	4	20	120	30	10		3108-M3x6			
AEM90-AX1235-D25-C20-L150-Z04-H	●	25	4	20	150	30	10		3008-M3x6			
AEM90-AX1235-D25-C24-L170-Z02-H	●	25	2	24	170	50	10		3108-M3x6			
AEM90-AX1235-D25-C25-L120-Z04-H	●	25	4	25	120	40	10		3008-M3x6			
AEM90-AX1235-D25-C25-L150-Z03	●	25	3	25	150	50	10		3108-M3x6			
AEM90-AX1235-D25-C25-L170-Z02-H	●	25	2	25	170	50	10		3008-M3x6			
AEM90-AX1235-D25-W25-L100-Z04-H	●	25	4	25	100	30	10		3108-M3x6			
AEM90-AX1235-D32-C32-L130-Z05-H	●	32	5	32	130	40	10		AX.T 1705..		4015-M4x9	80-T15
AEM90-AX1705-D25-C25-L150-Z02	●	25	2	25	150	50	14					
AEM90-AX1705-D28-W25-L115-Z02-H	●	28	2	25	115	35	14					
AEM90-AX1705-D32-C32-L150-Z03	●	32	3	32	150	50	14					
AEM90-AX1705-D32-C32-L180-Z02-H	●	32	2	32	180	50	14					

R: Sağ / Right / Rechts L: Sol/Left/Links



● Stokta / In Stock / Auf Lager ○ Stokta Yok / Non Stock Item / Kein Lagerartikel, Lieferzeit auf Anfrage
SMTM Ucuna Uygunudur. / Compatible with SMTM Insert. Kompatibel mit SMTM Wendepalten.

Sipariş Örneği/Ordering Example/Bestellbeispiel

1 ad./pcs./stück AX0235-D16-C14-L120-Z02-H

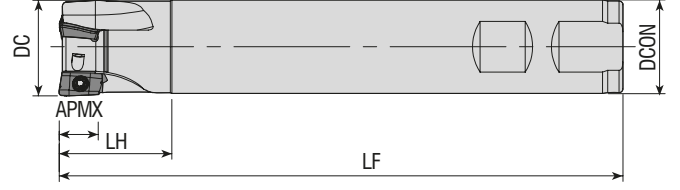
Kesme Hesabı : S 331 / Cutting Calculation : P 331 / Schnittberechnung : 331

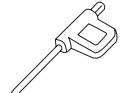

Takım Kodu Ordering Code Bestell-Bezeichnung	Stok Stock Lager	Takım Ölçüleri (mm) Dimension (mm) Abmessung (mm)						Kesici Uç Insert Wendeschneidplatte	Yedek Parçaları / Spare Parts / Ersatzteile				
		DC	ZEFP	DCON	LF	LH	APMX		Sıkma Vidası Screw Schraube	Tork Anahtar Torx Key Torx-Schlüssel			
AEM90-AZ11-D12-W16-L90-Z01	●	12	1	16	90	30	11						
AEM90-AZ11-D16-C16-L200-Z02	●	16	2	16	200	100	11						
AEM90-AZ11-D16-W15-L170-Z02	●	16	2	15	170	50	11						
AEM90-AZ11-D16-W16-L100-Z02	●	16	2	16	100	35	11						
AEM90-AZ11-D16-W16-L150-Z02	●	16	2	16	150	50	11						
AEM90-AZ11-D17-C16-L150-Z02	●	17	2	16	150	30	11						
AEM90-AZ11-D17-C16-L180-Z02	●	17	2	16	180	50	11						
AEM90-AZ11-D17-W16-L100-Z02	●	17	2	16	100	30	11						
AEM90-AZ11-D18-W16-L120-Z02	●	18	2	16	120	18	11						
AEM90-AZ11-D20-C20-L200-Z03	●	20	3	20	200	100	11				AZGT 1135..	3008-M2.5X6	80-T08
AEM90-AZ11-D20-W19-L170-Z03	●	20	3	19	170	50	11						
AEM90-AZ11-D20-W20-L110-Z02	●	20	2	20	110	35	11						
AEM90-AZ11-D21-C20-L150-Z03	●	21	3	20	150	30	11						
AEM90-AZ11-D21-C20-L180-Z03	●	21	3	20	180	50	11						
AEM90-AZ11-D21-W20-L110-Z03	●	21	3	20	110	35	11						
AEM90-AZ11-D22-C20-L150-Z02	●	22	2	20	150	30	11						
AEM90-AZ11-D25-C24-L180-Z04	●	25	4	24	180	50	11						
AEM90-AZ11-D25-W25-L110-Z04	●	25	4	25	110	40	11						
AEM90-AZ11-D26-C25-L250-Z02	●	26	2	25	250	50	11						
AEM90-AZ11-D26-W25-L120-Z03	●	26	3	25	120	30	11						
AEM90-AZ11-D26-W25-L120-Z04	●	26	4	25	120	40	11						
AEM90-AZ11-D28-C25-L180-Z03	●	28	3	25	180	50	11						
AEM90-AZ11-D28-C25-L250-Z02	●	28	2	25	250	50	11						
AEM90-AZ11-D33-W32-L130-Z04	●	33	4	32	130	50	11						

R: Sağ / Right / Rechts L: Sol/Left/Links
● Stokta / In Stock / Auf Lager ○ Stokta Yok / Non Stock Item / Kein Lagerartikel, Lieferzeit auf Anfrage
ZCC Ucuna Uygundur. / Compatible with ZCC Insert. Kompatibel mit ZCC Wendeplatten.

Sipariş Örneği/Ordering Example/Bestellbeispiel
1 ad./pcs./stück AEM90-AZ11-D12-W16-L90-Z01
Kesme Hesabı : S 331 / Cutting Calculation : P 331 / Schnittberechnung : 331

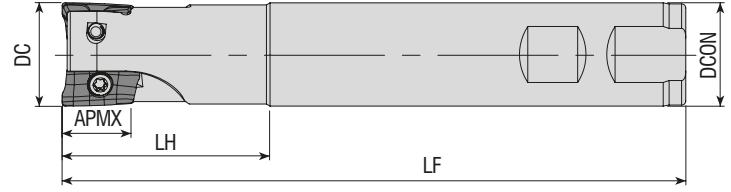

Takım Kodu Ordering Code Bestell-Bezeichnung	Stok Stock Lager	Takım Ölçüleri (mm) Dimension (mm) Abmessung (mm)						Kesici Uç Insert Wendeschneidplatte	Yedek Parçaları / Spare Parts / Ersatzteile		
		DC	ZEFP	DCON	LF	LH	APMX		Sıkma Vidası Screw Schraube	Tork Anahtar Torx Key Torx-Schlüssel	
AEM90-BD11T3-D16-C15-L180-Z02	●	16	2	15	180	50	10				
AEM90-BD11T3-D16-C16-L100-Z02-H	●	16	2	16	100	30	10				
AEM90-BD11T3-D16-W16-L100-Z02-H	●	16	2	16	100	30	10				
AEM90-BD11T3-D16-W16-L150-Z02	●	16	2	16	150	50	10				
AEM90-BD11T3-D17-W16-L150-Z02	●	17	2	16	150	25	10				
AEM90-BD11T3-D17-C16-L180-Z02	●	17	2	16	180	25	10				
AEM90-BD11T3-D18-W16-L100-Z02	●	18	2	16	100	25	10				
AEM90-BD11T3-D18-W16-L100-Z02-H	●	18	2	16	100	25	10				
AEM90-BD11T3-D20-W20-L100-Z02-H	●	20	2	20	100	30	10				
AEM90-BD11T3-D20-W20-L100-Z03-H	●	20	3	20	100	30	10				
AEM90-BD11T3-D20-C20-L110-Z03-H	●	20	3	30	110	30	10				
AEM90-BD11T3-D20-W20-L150-Z02	●	20	2	20	150	50	10				
AEM90-BD11T3-D20-W20-L150-Z03	●	20	3	20	150	50	10				
AEM90-BD11T3-D20-W20-L150-Z03-H	●	20	3	20	150	50	10				
AEM90-BD11T3-D21-W20-L150-Z03	●	21	3	20	150	25	10				
AEM90-BD11T3-D21-C20-L200-Z02	●	21	2	20	200	25	10				
AEM90-BD11T3-D22-W20-L090-Z02-H	●	22	2	20	90	25	10				
AEM90-BD11T3-D25-W25-L100-Z03-H	●	25	3	25	100	30	10				
AEM90-BD11T3-D25-C25-L120-Z03-H	●	25	3	25	120	30	10				
AEM90-BD11T3-D25-W25-L150-Z03	●	25	3	25	150	50	10				
AEM90-BD11T3-D26-W25-L150-Z03	●	26	3	25	150	35	10				
AEM90-BD11T3-D26-C25-L250-Z02	●	26	2	25	250	35	10				
AEM90-BD11T3-D32-W32-L110-Z04-H	●	32	4	32	110	40	10				
AEM90-BD11T3-D32-C32-L130-Z04-H	●	32	4	32	130	40	10				
AEM90-BD11T3-D32-W32-L150-Z04	●	32	4	32	150	50	10				
AEM90-BD11T3-D40-W32-L110-Z04-H	●	40	4	32	110	35	10				
AEM90-BD1704-D25-W25-L100-Z02-H	●	25	2	25	100	35	15.7			80-T15	
AEM90-BD1704-D25-W25-L150-Z02	●	25	2	25	150	50	15.7				
AEM90-BD1704-D32-W32-L110-Z03-H	●	32	3	32	110	40	15.7				
AEM90-BD1704-D32-W32-L150-Z03	●	32	3	32	150	50	15.7				
AEM90-BD1704-D40-W32-L110-Z04-H	●	40	4	32	110	40	15.7				
AEM90-BD1704-D40-W32-L150-Z04	●	40	4	32	150	40	15.7				

R: Sağ / Right / Rechts L: Sol/Left/Links

● Stokta / In Stock / Auf Lager ○ Stokta Yok / Non Stock Item / Kein Lagerartikel, Lieferzeit auf Anfrage
KYCR Ucuna Uygunudur. / Compatiple with KYCR Insert. Kompatibel mit KYCR Wendeplatten.

Sipariş Örneği/Ordering Example/Bestellbeispiel

1 ad./pcs./stück AEM90-BD11T3-D16-C15-L180-Z02

Kesme Hesabı : S 331 / Cutting Calculation : P 331 / Schnittberechnung : 331

S-SİSTEM YÜZEY PARMAK FREZELER

S-SYSTEM END MILLS

S-SYSTEM SCHAFTFRÄSER

KAPR=90°

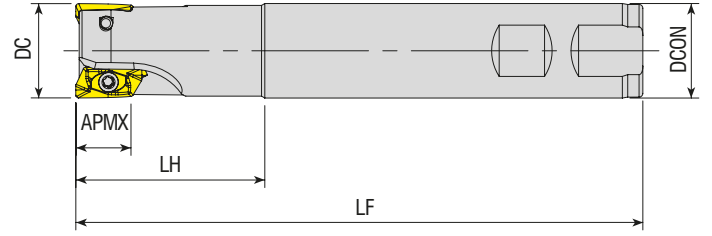

Takım Kodu Ordering Code Bestell-Bezeichnung	Stok Stock Lager	Takım Ölçüleri (mm) Dimension (mm) Abmessung (mm)						Kesici Uç Insert Wendeschneidplatte	Yedek Parçaları / Spare Parts / Ersatzteile	
		DC	ZEP	DCON	LF	LH	APMX		Sıkma Vidası Screw Schraube	Tork Anahtar Torx Key Torx-Schlüssel
AEM90-ED10T3-D16-W16-L120-Z02	●	16	2	16	120	30	30	EDPT 10T3..	3008-M2.5x5	80-T08
AEM90-ED10T3-D20-W20-L120-Z02	●	20	2	20	120	30	30		3008-M2.5x6	
AEM90-ED1404-D20-W20-L150-Z02	●	20	2	20	150	50	14.5	EDPT 1404..	3008-M3x6	
AEM90-ED1404-D25-W25-L150-Z02	●	25	2	25	150	50	14.5			
AEM90-ED1404-D30-C25-L150-Z03	●	30	3	25	150	50	14.5			

KNMTL Ucuna Uygunudur. / Compatible with KNMTL Insert. Kompatibel mit KNMTL Wendeplatten.

KAPR=90°

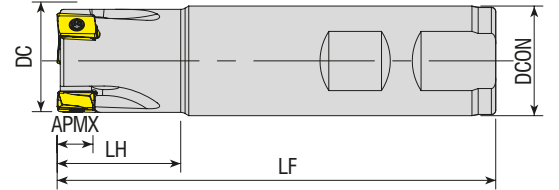

Takım Kodu Ordering Code Bestell-Bezeichnung	Stok Stock Lager	Takım Ölçüleri (mm) Dimension (mm) Abmessung (mm)						Kesici Uç Insert Wendeschneidplatte	Yedek Parçaları / Spare Parts / Ersatzteile	
		DC	ZEP	DCON	LF	LH	APMX		Sıkma Vidası Screw Schraube	Tork Anahtar Torx Key Torx-Schlüssel
AEM90-LN08-D16-W16-L100-Z02-H	●	16	2	16	100	28	8	LNMT 0804..	1707-U4-48x6	80-T07
AEM90-LN08-D16-W16-L150-Z02	●	16	2	16	150	40	8			
AEM90-LN08-D20-W20-L100-Z03-H	●	20	3	20	100	28	8		1707-U4-48x8.2	
AEM90-LN08-D25-W25-L100-Z03-H	●	25	3	25	100	30	8			
AEM90-LN08-D32-W32-L110-Z05-H	●	32	5	32	110	30	8			

R: Sağ / Right / Rechts L: Sol/Left/Links

● Stokta / In Stock / Auf Lager ○ Stokta Yok / Non Stock Item / Kein Lagerartikel, Lieferzeit auf Anfrage
ISCR Ucuna Uygunudur. / Compatible with ISCR Insert. Kompatibel mit ISCR Wendeplatten.

Sipariş Örneği/Ordering Example/Bestellbeispiel

1 ad./pcs./stück AEM90-ED10T3-D16-W16-L120-Z02

Kesme Hesabı : S 331 / Cutting Calculation : P 331 / Schnittberechnung : 331



www.akkо.com.tr

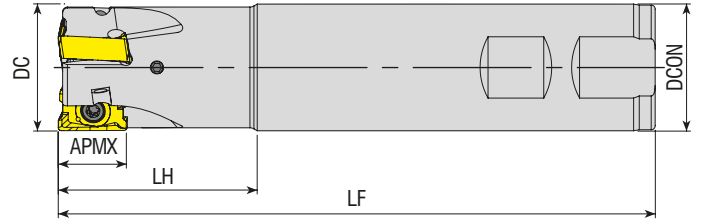

Takım Kodu Ordering Code Bestell-Bezeichnung	Stok Stock Lager	Takım Ölçüleri (mm) Dimension (mm) Abmessung (mm)						Kesici Uç Insert Wendeschneidplatte	Yedek Parçaları / Spare Parts / Ersatzteile		
		DC	ZEFP	DCON	LF	LH	APMX		Sıkma Vidası Screw Schraube	Tork Anahtar Torx Key Torx-Schlüssel	
AEM90-LN15T6-D25-W25-L150-Z02-H	●	25	2	25	150	50	15.5	LNGU 15T6..	4015-M4x12	80-T15	
AEM90-LN15T6-D32-W32-L150-Z03-H	●	32	3	32	150	50	15.5				
AEM90-LN15T6-D40-W32-L150-Z03-H	●	40	3	32	150	40	15.5				

KNMTL Ucuna Uygunur. / Compatible with KNMTL Insert. Kompatibel mit KNMTL Wendeplatten.

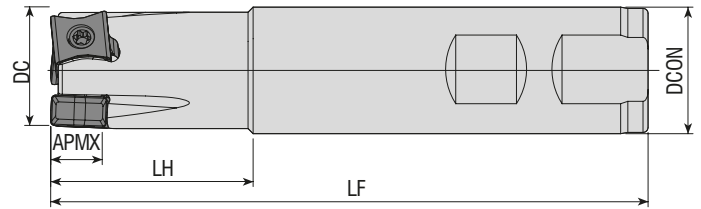

Takım Kodu Ordering Code Bestell-Bezeichnung	Stok Stock Lager	Takım Ölçüleri (mm) Dimension (mm) Abmessung (mm)						Kesici Uç Insert Wendeschneidplatte	Yedek Parçaları / Spare Parts / Ersatzteile		
		DC	ZEFP	DCON	LF	LH	APMX		Sıkma Vidası Screw Schraube	Tork Anahtar Torx Key Torx-Schlüssel	
AEM90-LN1106-D25-W25-L150-Z03	●	25	3	25	150	40	10	LNMT 1106..	4015-M3.5x11	80-T15	
AEM90-LN1106-D32-W32-L150-Z04	●	32	4	32	150	40	10				
AEM90-LN1106-D40-W32-L150-Z05	●	40	5	32	150	40	10				

R: Sağ / Right / Rechts L: Sol/Left/Links

● Stokta / In Stock / Auf Lager ○ Stokta Yok / Non Stock Item / Kein Lagerartikel, Lieferzeit auf Anfrage

ISCR-XTC-GSC Ucuna Uygunur. / Compatible with ISCR-XTC-GSC Insert. Kompatibel mit ISCR-XTC-GSC Wendeplatten.

Sipariş Örneği/Ordering Example/Bestellbeispiel

1 ad./pcs./stück AEM90-LN15T6-D25-W25-L150-Z02-H

Kesme Hesabı : S 331 / Cutting Calculation : P 331 / Schnittberechnung : 331

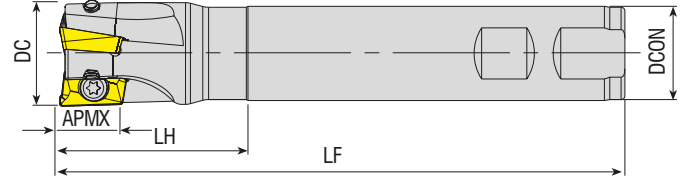

Takım Kodu Ordering Code Bestell-Bezeichnung	Stok Stock Lager	Takım Ölçüleri (mm) Dimension (mm) Abmessung (mm)						Kesici Uç Insert Wendeschneidplatte	Yedek Parçaları / Spare Parts / Ersatzteile	
		DC	ZEPF	DCON	LF	LH	APMX		Sıkma Vidası Screw Schraube	Tork Anahtar Torx Key Torx-Schlüssel
AEM90-R390.11-D16-W16-L100-Z02-H	●	16	2	16	100	30	10	R390-11T3..	3008-M2.5x5	80-T08
AEM90-R390.11-D16-W16-L150-Z02	●	16	2	16	150	50	10			
AEM90-R390.11-D16-W16-L150-Z02-H	●	16	2	16	150	50	10			
AEM90-R390.11-D20-W20-L090-Z02-H	●	20	2	20	90	30	10			
AEM90-R390.11-D20-W20-L100-Z03-H	●	20	3	20	100	30	10			
AEM90-R390.11-D20-W20-L150-Z03	●	20	3	20	150	50	10			
AEM90-R390.11-D20-W20-L150-Z03-H	●	20	3	20	150	50	10			
AEM90-R390.11-D20-C20-L150-Z03	●	20	3	20	150	30	10			
AEM90-R390.11-D22-W20-L090-Z02-H	●	22	2	20	90	30	10			
AEM90-R390.11-D25-C20-L150-Z03	●	25	3	20	150	40	10			
AEM90-R390.11-D25-W25-L100-Z03-H	●	25	3	25	100	30	10			
AEM90-R390.11-D25-W25-L150-Z03	●	25	3	25	150	50	10			
AEM90-R390.11-D25-W25-L150-Z03-H	●	25	3	25	150	50	10			
AEM90-R390.11-D30-W25-L150-Z04-H	●	30	4	25	150	30	10			
AEM90-R390.11-D32-C25-L200-Z03	●	32	3	25	200	40	10			
AEM90-R390.11-D32-W32-L150-Z05-H	●	32	5	32	150	50	10			
AEM90-R390.17-D25-W25-L150-Z02	●	25	2	25	150	50	15.4	R390-1704..	4015-M3.5x8	80-T15
AEM90-R390.17-D25-W25-L150-Z02-H	●	25	2	25	150	50	15.4			
AEM90-R390.17-D30-W25-L150-Z03	●	30	3	25	150	40	15.4			
AEM90-R390.17-D30-W25-L150-Z03-H	●	30	3	25	150	40	15.4			
AEM90-R390.17-D32-W32-L150-Z03-H	●	32	3	32	150	40	15.4			
AEM90-R390.18-D32-C32-L150-Z03	●	32	3	32	150	45	15.4	R390-1806..	4015-M4x11	

R: Sağ / Right / Rechts L: Sol/Left/Links
● Stokta / In Stock / Auf Lager ○ Stokta Yok / Non Stock Item / Kein Lagerartikel, Lieferzeit auf Anfrage
SNDVK Ucuna Uygunudur. / Compatible with SNDVK Insert. Kompatibel mit SNDVK Wendeplatten.

Sipariş Örneği/Ordering Example/Bestellbeispiel
1 ad./pcs./stück AEM90-R390.11-D16-W16-L100-Z02-H
Kesme Hesabı : S 331 / Cutting Calculation : P 331 / Schnittberechnung : 331

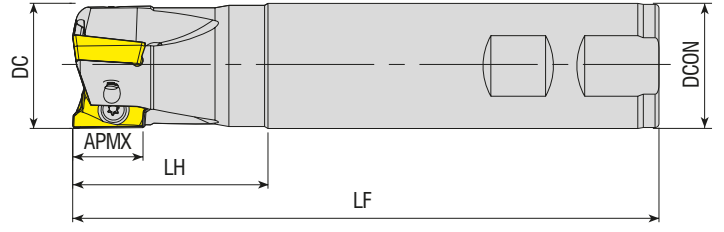

Takım Kodu Ordering Code Bestell-Bezeichnung	Stok Stock Lager	Takım Ölçüleri (mm) Dimension (mm) Abmessung (mm)						Kesici Uç Insert Wendeschneidplatte	Yedek Parçaları / Spare Parts / Ersatzteile	
		DC	ZEFP	DCON	LF	LH	APMX		Sıkma Vidası Screw Schraube	Tork Anahtar Torx Key Torx-Schlüssel
AEM90-RT07-D10-W10-L120-Z02	●	10	2	10	120	30	7	RT 0702	3006-M2x4	80-T06
AEM90-RT07-D12-C12-L120-Z02	●	12	2	12	120	30	7			
AEM90-RT07-D12-W12-L120-Z02	●	12	2	12	120	30	7			
AEM90-RT07-D14-W12-L120-Z02	●	14	2	12	120	30	7			
AEM90-RT10-D16-C15-L160-Z02	●	16	2	15	160	30	10	RT 1003	3008-M2.5x6	80-T08
AEM90-RT10-D16-W16-L120-Z02-H	●	16	2	16	120	30	10			
AEM90-RT10-D16-W16-L150-Z02	●	16	2	16	150	50	10			
AEM90-RT10-D16-C16-L200-Z02	●	16	2	16	200	100	10			
AEM90-RT10-D17-W16-L160-Z02	●	17	2	16	160	30	10			
AEM90-RT10-D17-C16-L200-Z02	●	17	2	16	200	30	10			
AEM90-RT10-D18-W16-L120-Z02-H	●	18	2	16	120	30	10			
AEM90-RT10-D20-C19-L200-Z03	●	20	3	19	200	30	10			
AEM90-RT10-D20-C20-L110-Z03	●	20	3	20	110	30	10			
AEM90-RT10-D20-W20-L120-Z03-H	●	20	3	20	120	30	10			
AEM90-RT10-D20-W20-L150-Z03	●	20	3	20	150	50	10			
AEM90-RT10-D20-C20-L200-Z03	●	20	3	20	200	100	10			
AEM90-RT10-D21-W20-L200-Z03	●	21	3	20	200	30	10			
AEM90-RT10-D22-W20-L120-Z03-H	●	22	3	20	120	30	10			
AEM90-RT10-D22-C20-L150-Z03	●	22	3	20	150	30	10			
AEM90-RT10-D22-C20-L200-Z03	●	22	3	20	200	30	10			
AEM90-RT10-D25-W25-L120-Z04-H	●	25	4	25	120	40	10			
AEM90-RT10-D25-W25-L150-Z04	●	25	4	25	150	50	10			
AEM90-RT10-D25-C25-L200-Z04	●	25	4	25	200	100	10			
AEM90-RT10-D26-C25-L250-Z04	●	26	4	25	250	32	10			
AEM90-RT10-D32-W32-L120-Z05-H	●	32	5	32	120	50	10			
AEM90-RT10-D32-W32-L150-Z05	●	32	5	32	150	50	10			
AEM90-RT10-D32-C32-L200-Z05	●	32	5	32	200	100	10			
AEM90-RT10-D33-C32-L250-Z04	●	33	4	32	250	32	10			
AEM90-RT13-D32-C32-L250-Z04	●	32	4	32	250	50	13	RT 1304	3008-M3x8	
AEM90-RT16-D25-W25-L120-Z02-H	●	25	2	25	120	40	16	RT 1606	4015-M4x9	80-T15
AEM90-RT16-D25-W25-L150-Z02	●	25	2	25	150	50	16			
AEM90-RT16-D25-C25-L200-Z02	●	25	2	25	200	100	16			
AEM90-RT16-D32-W32-L120-Z03-H	●	32	3	32	120	50	16			
AEM90-RT16-D32-W32-L150-Z03	●	32	3	32	150	50	16			
AEM90-RT16-D32-C32-L200-Z03	●	32	3	32	200	100	16			
AEM90-RT16-D32-C32-L250-Z03	●	32	3	32	250	100	16			
AEM90-RT16-D32-C32-L270-Z03	●	32	3	32	270	100	16			
AEM90-RT16-D40-W32-L120-Z04-H	●	40	4	32	120	50	16			
AEM90-RT16-D40-W32-L150-Z04	●	40	4	32	150	50	16			
AEM90-RT16-D40-C32-L200-Z04	●	40	4	32	200	100	16		4015-M4x11	

R: Sağ / Right / Rechts L: Sol/Left/Links

● Stokta / In Stock / Auf Lager ○ Stokta Yok / Non Stock Item / Kein Lagerartikel, Lieferzeit auf Anfrage
SFTY Ucuna Uygunudur. / Compatiple with SFTY Insert. Kompatibel mit SFTY Wendepplatten.

Sipariş Örneği/Ordering Example/Bestellbeispiel

1 ad./pcs./stück AEM90-RT07-D10-W10-L120-Z02

Kesme Hesabı : S 331 / Cutting Calculation : P 331 / Schnittberechnung : 331

KAPR=90°

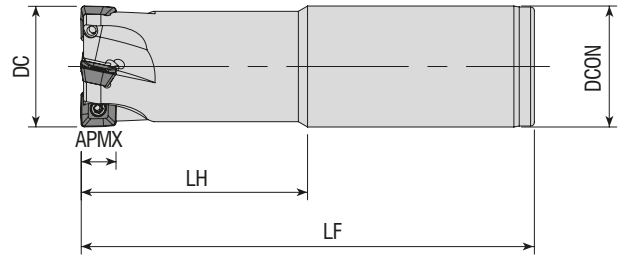

Takım Kodu Ordering Code Bestell-Bezeichnung	Stok Stock Lager	Takım Ölçüleri (mm) Dimension (mm) Abmessung (mm)						Kesici Uç Insert Wendeschneidplatte	Yedek Parçaları / Spare Parts / Ersatzteile	
		DC	ZAFP	DCON	LF	LH	APMX		Sıkma Vidası Screw Schraube	Tork Anahtar Torx Key Torx-Schlüssel
AEM90-SE09-D25-C25-L120-Z03-H	●	25	3	25	120	60	6.7	SEET 09T3..	3008-M3x8	80-T08
AEM90-SE09-D25-C25-L150-Z02	●	25	2	25	150	50	6.7			
AEM90-SE09-D32-C32-L120-Z04-H	●	32	4	32	120	60	6.7			
AEM90-SE09-D32-C32-L150-Z03	●	32	3	32	150	50	6.7			

ZCC Ucuna Uygun. / Compatible with ZCC Insert. Kompatibel mit ZCC Wendeplatten.

KAPR=90°

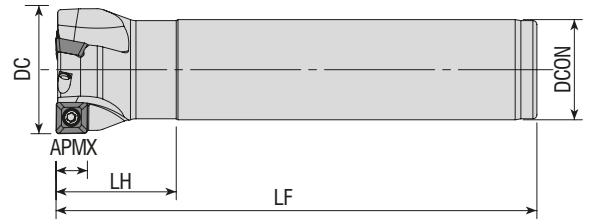

Takım Kodu Ordering Code Bestell-Bezeichnung	Stok Stock Lager	Takım Ölçüleri (mm) Dimension (mm) Abmessung (mm)						Kesici Uç Insert Wendeschneidplatte	Yedek Parçaları / Spare Parts / Ersatzteile	
		DC	ZAFP	DCON	LF	LH	APMX		Sıkma Vidası Screw Schraube	Tork Anahtar Torx Key Torx-Schlüssel
AEM90-S00803-D20-C16-L110-Z02-H	●	20	2	16	110	25	7	SOMT 0803..	3008-M3x7	80-T08
AEM90-S00803-D25-C20-L110-Z02-H	●	25	2	20	110	25	7			
AEM90-S00803-D32-C25-L120-Z03-H	●	32	3	25	120	30	7			

R: Sağ / Right / Rechts L: Sol/Left/Links

● Stokta / In Stock / Auf Lager ○ Stokta Yok / Non Stock Item / Kein Lagerartikel, Lieferzeit auf Anfrage

SMTM Ucuna Uygun. / Compatible with SMTM Insert. Kompatibel mit SMTM Wendeplatten.

Sipariş Örneği/Ordering Example/Bestellbeispiel

1 ad./pcs./stück AEM90-SE09-D25-C25-L120-Z03-H

Kesme Hesabı : S 331 / Cutting Calculation : P 331 / Schnittberechnung : 331

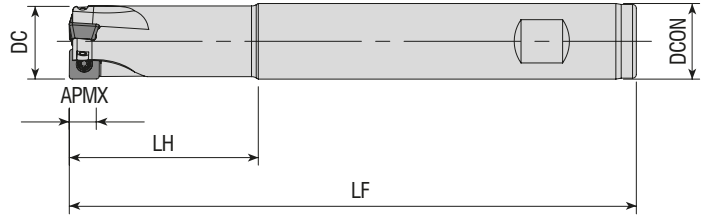

Takım Kodu Ordering Code Bestell-Bezeichnung	Stok Stock Lager	Takım Ölçüleri (mm) Dimension (mm) Abmessung (mm)						Kesici Uç Insert Wendeschneidplatte	Yedek Parçaları / Spare Parts / Ersatzteile		
		DC	ZEFP	DCON	LF	LH	APMX		Sıkma Vidası Screw Schraube	Tork Anahtar Torx Key Torx-Schlüssel	
AEM90-SPGT0602-D16-W16-L150-Z02	●	16	2	16	150	50	5.5				
AEM90-SPGT07T3-D20-W20-L150-Z03	●	20	3	20	150	50	7	SPGT 07T308	3008-M2.5x6	80-T08	
AEM90-SPGT07T3-D25-W25-L150-Z03	●	25	3	25	150	50	7				
AEM90-SPGT0904-D30-W32-L150-Z03	●	30	3	32	150	50	9	SPGT 090408	4015-M3.5x9	80-T15	

ZCC Ucuna Uygundur. / Compatible with ZCC Insert. Kompatibel mit ZCC Wendeplatten.

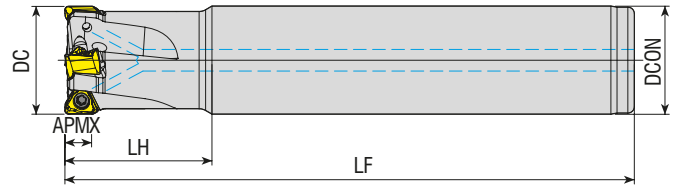

Takım Kodu Ordering Code Bestell-Bezeichnung	Stok Stock Lager	Takım Ölçüleri (mm) Dimension (mm) Abmessung (mm)						Kesici Uç Insert Wendeschneidplatte	Yedek Parçaları / Spare Parts / Ersatzteile		
		DC	ZEFP	DCON	LF	LH	APMX		Sıkma Vidası Screw Schraube	Tork Anahtar Torx Key Torx-Schlüssel	
AEM90-TNG10-D20-C20-L125-Z02-H	●	20	2	20	125	29	5				
AEM90-TNG10-D20-C20-L125-Z03-H	●	20	3	20	125	29	5				
AEM90-TNG10-D20-C20-L150-Z03-H	○	20	3	20	150	50	5				
AEM90-TNG10-D25-C25-L150-Z03-H	●	25	3	25	150	34	5				
AEM90-TNG10-D25-C25-L150-Z04-H	●	25	4	25	150	34	5				
AEM90-TNG10-D25-C25-L170-Z04-H	○	25	4	25	170	50	5				
AEM90-TNG10-D32-C32-L170-Z04-H	●	32	4	32	170	37	5				
AEM90-TNG10-D32-C32-L170-Z05-H	○	32	5	32	170	37	5				

R: Sağ / Right / Rechts L: Sol/Left/Links

● Stokta / In Stock / Auf Lager ○ Stokta Yok / Non Stock Item / Kein Lagerartikel, Lieferzeit auf Anfrage
PRMT Ucuna Uygundur. / Compatible with PRMT Insert. Kompatibel mit PRMT Wendeplatten.

Sipariş Örneği/Ordering Example/Bestellbeispiel

1 ad./pcs./stück AEM90-SPGT0602-D16-W16-L150-Z02

Kesme Hesabı : S 331 / Cutting Calculation : P 331 / Schnittberechnung : 331

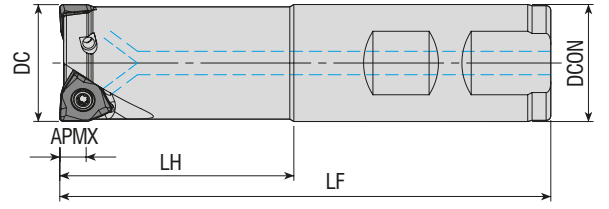

Takım Kodu Ordering Code Bestell-Bezeichnung	Stok Stock Lager	Takım Ölçüleri (mm) Dimension (mm) Abmessung (mm)						Kesici Uç Insert Wendeschneidplatte	Yedek Parçaları / Spare Parts / Ersatzteile	
		DC	ZEFP	DCON	LF	LH	APMX		Sıkma Vidası Screw Schraube	Tork Anahtar Torx Key Torx-Schlüssel
AEM90-WN0604Z-D25-W25-L150-Z02-H	●	25	2	25	150	50	5.7	WNHU 0604..	3008-M3x8	80-T08
AEM90-WN0604Z-D32-W32-L150-Z03-H	●	32	3	32	150	50	5.7			
AEM90-WN0604Z-D40-W32-L150-Z04-H	●	40	4	32	150	35	5.7			

ZCC Ucuna Uygunur. / Compatible with ZCC Insert. Kompatibel mit ZCC Wendeplatten.

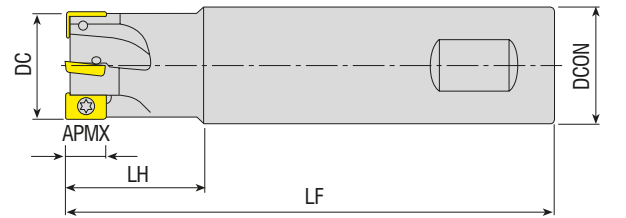

Takım Kodu Ordering Code Bestell-Bezeichnung	Stok Stock Lager	Takım Ölçüleri (mm) Dimension (mm) Abmessung (mm)						Kesici Uç Insert Wendeschneidplatte	Yedek Parçaları / Spare Parts / Ersatzteile	
		DC	ZEFP	DCON	LF	LH	APMX		Sıkma Vidası Screw Schraube	Tork Anahtar Torx Key Torx-Schlüssel
AEM90-XD11T3-D16-W16-L150-Z02	●	16	2	16	150	30	10	XD.T 11T3..	3008-M2.5x5	80-T08
AEM90-XD11T3-D17-C16-L150-Z02	●	17	2	16	150	30	10			
AEM90-XD11T3-D20-W20-L150-Z03	●	20	3	20	150	50	10			
AEM90-XD11T3-D21-C20-L080-Z03-H	●	21	3	20	80	25	10			
AEM90-XD11T3-D21-C20-L150-Z03	●	21	3	20	150	30	10			
AEM90-XD11T3-D25-W25-L150-Z04	●	25	4	25	150	50	10			
AEM90-XD11T3-D30-W25-L120-Z04	●	30	4	25	120	30	10			
AEM90-XD11T3-D32-W32-L150-Z04	●	32	4	32	150	50	10			
AEM90-XD11T3-D33-C20-L080-Z04-H	●	33	4	20	80	30	10			

R: Sağ / Right / Rechts L: Sol/Left/Links

● Stokta / In Stock / Auf Lager ○ Stokta Yok / Non Stock Item / Kein Lagerartikel, Lieferzeit auf Anfrage
CRTZT Ucuna Uygunur. / Compatible with CRTZT Insert. Kompatibel mit CRTZT Wendeplatten.

Sipariş Örneği/Ordering Example/Bestellbeispiel

1 ad./pcs./stück AEM90-XD11T3-D16-W16-L150-Z02

Kesme Hesabı : S 331 / Cutting Calculation : P 331 / Schnittberechnung : 331

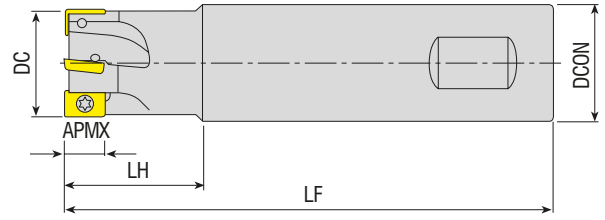

Takım Kodu Ordering Code Bestell-Bezeichnung	Stok Stock Lager	Takım Ölçüleri (mm) Dimension (mm) Abmessung (mm)						Kesici Uç Insert Wendeschneidplatte	Yedek Parçaları / Spare Parts / Ersatzteile		
		DC	ZEFP	DCON	LF	LH	APMX		Sıkma Vidası Screw Schraube	Tork Anahtar Torx Key Torx-Schlüssel	
AEM90-XC13-D20-W20-L150-Z02	●	20	2	20	150	60	13	XCKX 13T3..	3008-M3x6	80-T08	
AEM90-XC13-D25-W25-L150-Z03	●	25	3	25	150	60	13		3008-M3x8		
AEM90-XC13-D32-W32-L150-Z04	●	32	4	32	150	60	13				

SC Ucuna Uygunur. / Compatiple with SC Insert. Kompatibel mit SC Wendeplatten.

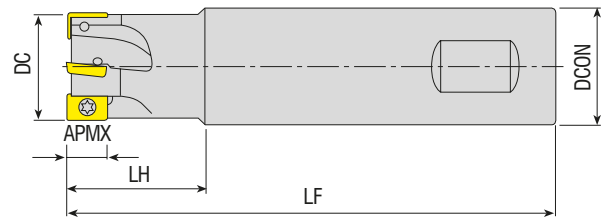

Takım Kodu Ordering Code Bestell-Bezeichnung	Stok Stock Lager	Takım Ölçüleri (mm) Dimension (mm) Abmessung (mm)						Kesici Uç Insert Wendeschneidplatte	Yedek Parçaları / Spare Parts / Ersatzteile		
		DC	ZEFP	DCON	LF	LH	APMX		Sıkma Vidası Screw Schraube	Tork Anahtar Torx Key Torx-Schlüssel	
AEM90-X006-D10-C12-L120-Z02	●	10	2	12	120	50	5	XO.. 0602..	3006-M1.8x4	80-T06	
AEM90-X006-D12-C12-L120-Z02	●	12	2	12	120	25	5				
AEM90-X009-D16-W16-L150-Z02	●	16	2	16	150	50	8	XO.. 0903..	3008-M2.5x5	80-T08	
AEM90-X009-D20-W20-L150-Z03	●	20	3	20	150	50	8				
AEM90-X012-D20-W20-L150-Z02	●	20	2	20	150	50	11	XO.. 1204..	3010-M3.5x7	80-T10	
AEM90-X012-D20-C20-L200-Z02	●	20	2	20	200	100	11				
AEM90-X012-D22-W20-L150-Z02	●	22	2	20	150	30	11				
AEM90-X012-D25-W25-L150-Z03	●	25	3	25	150	50	11				
AEM90-X012-D25-C25-L200-Z03	●	25	3	25	200	100	11				
AEM90-X012-D32-C25-L150-Z04	●	32	4	25	150	40	11				
AEM90-X012-D32-W32-L150-Z04	●	32	4	32	150	50	11				
AEM90-X012-D32-C32-L250-Z04	●	32	4	32	250	100	11				

R: Sağ / Right / Rechts L: Sol/Left/Links

● Stokta / In Stock / Auf Lager ○ Stokta Yok / Non Stock Item / Kein Lagerartikel, Lieferzeit auf Anfrage
SC Ucuna Uygunur. / Compatiple with SC Insert. Kompatibel mit SC Wendeplatten.

Sipariş Örneği/Ordering Example/Bestellbeispiel

1 ad./pcs./stück AEM90-XC13-D20-W20-L150-Z02

Kesme Hesabı : S 331 / Cutting Calculation : P 331 / Schnittberechnung : 331



KAPR=90°

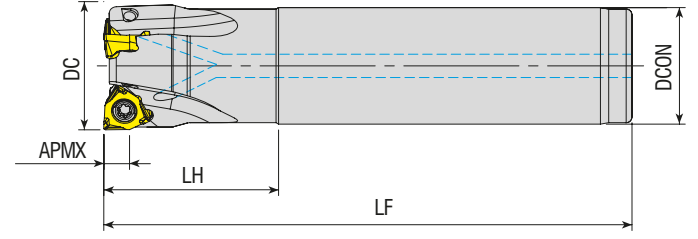

Takım Kodu Ordering Code Bestell-Bezeichnung	Stok Stock Lager	Takım Ölçüleri (mm) Dimension (mm) Abmessung (mm)						Kesici Uç Insert Wendeschneidplatte	Yedek Parçaları / Spare Parts / Ersatzteile				
		DC	ZEFP	DCON	LF	LH	APMX		Sıkma Vidası Screw Schraube	Tork Anahtar Torx Key Torx-Schlüssel			
AEM90-XN0403-D16-C16-L100-Z01-H	●	16	1	16	100	30	4						
AEM90-XN0403-D22-C20-L110-Z03-H	●	22	3	20	110	30	4				XNEX 0403..	4008-M2.5x6	80-T08
AEM90-XN0806-D32-C32-L110-Z02-H	●	32	2	32	110	40	7.5				XNEX 0806..	4015-M4x11	80-T15

SC Ucuna Uygun. / Compatible with SC Insert. Kompatibel mit SC Wendeplatten.

KAPR=90°

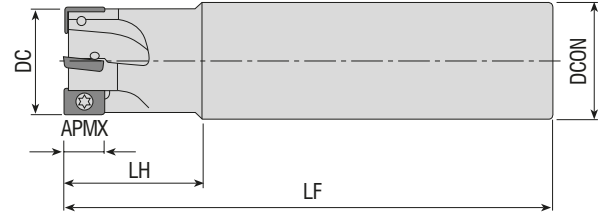

Takım Kodu Ordering Code Bestell-Bezeichnung	Stok Stock Lager	Takım Ölçüleri (mm) Dimension (mm) Abmessung (mm)						Kesici Uç Insert Wendeschneidplatte	Yedek Parçaları / Spare Parts / Ersatzteile	
		DC	ZEFP	DCON	LF	LH	APMX		Sıkma Vidası Screw Schraube	Tork Anahtar Torx Key Torx-Schlüssel
AEM90-ZC1003-D16-C14-L150-Z02	●	16	2	14	150	25	9			
AEM90-ZC1003-D16-C14-L200-Z02	●	16	2	14	200	25	9			
AEM90-ZC1003-D16-C15-L150-Z02	●	16	2	15	150	25	9			
AEM90-ZC1003-D16-C16-L150-Z02	●	16	2	16	150	25	9			
AEM90-ZC1003-D17-C16-L150-Z02	●	17	2	16	150	25	9			
AEM90-ZC1003-D17-C16-L200-Z02	●	17	2	16	200	25	9			
AEM90-ZC1003-D20-C18-L150-Z03	●	20	3	18	150	25	9			
AEM90-ZC1003-D20-C18-L200-Z02	●	20	2	18	200	25	9			
AEM90-ZC1003-D20-C20-L150-Z03	●	20	3	20	150	40	9			
AEM90-ZC1003-D20-C18-L200-Z03	●	20	3	18	200	25	9			
AEM90-ZC1003-D21-C20-L150-Z02	●	21	2	20	150	30	9			
AEM90-ZC1003-D21-C20-L150-Z03	●	21	3	20	150	30	9			
AEM90-ZC1003-D21-C20-L200-Z03	●	21	3	20	200	30	9			
AEM90-ZC1003-D25-C20-L150-Z03	●	25	3	20	150	30	9			
AEM90-ZC1003-D25-C20-L200-Z03	●	25	3	20	200	30	9			
AEM90-ZC1003-D25-C25-L150-Z03	●	25	3	25	150	40	9			
AEM90-ZC1003-D26-C25-L170-Z03	●	26	3	25	170	25	9			
AEM90-ZC1003-D26-C25-L200-Z03	●	26	3	25	200	25	9			
AEM90-ZC1003-D32-C25-L180-Z04	●	32	4	25	180	30	9			
AEM90-ZC1003-D33-C32-L200-Z04	●	33	4	32	200	25	9			

R: Sağ / Right / Rechts L: Sol/Left/Links

● Stokta / In Stock / Auf Lager ○ Stokta Yok / Non Stock Item / Kein Lagerartikel, Lieferzeit auf Anfrage
DJT Ucuna Uygun. / Compatible with DJT Insert. Kompatibel mit DJT Wendeplatten.

Sipariş Örneği/Ordering Example/Bestellbeispiel

1 ad./pcs./stück AEM90-XN0403-D16-C16-L110-Z01-H

Kesme Hesabı : S 331 / Cutting Calculation : P 331 / Schnittberechnung : 331

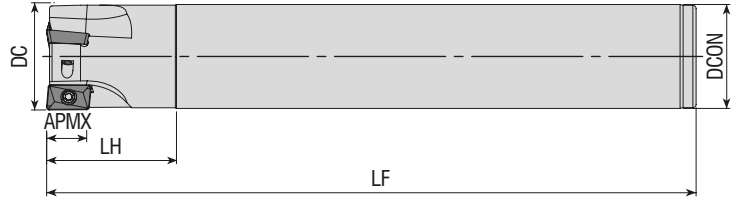

Takım Kodu Ordering Code Bestell-Bezeichnung	Stok Stock Lager	Takım Ölçüleri (mm) Dimension (mm) Abmessung (mm)						Kesici Uç Insert Wendeschneidplatte	Yedek Parçaları / Spare Parts / Ersatzteile	
		DC	ZEPF	DCON	LF	LH	APMX		Sıkma Vidası Screw Schraube	Tork Anahtar Torx Key Torx-Schlüssel
AEM90-ZP13T3-D26-C25-L200-Z02	●	26	2	25	200	35	13	ZPMT 13T3..	4010-M3x8	80-T10
AEM90-ZP13T3-D26-C25-L200-Z03	●	26	3	25	200	35	13			
AEM90-ZP13T3-D26-C25-L250-Z02	●	26	2	25	250	35	13			
AEM90-ZP13T3-D33-C32-L200-Z03	●	33	3	32	200	40	13			
AEM90-ZP13T3-D33-C32-L250-Z03	●	33	3	32	250	40	13			

DJT Ucuna Uygundur. / Compatiple with DJT Insert. Kompatibel mit DJT Wendeplatten.

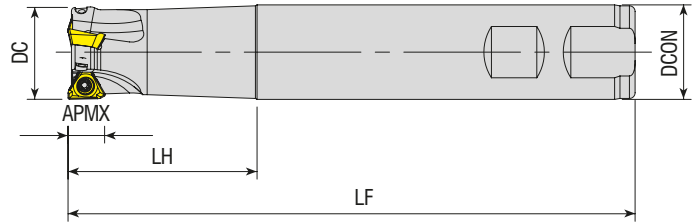

Takım Kodu Ordering Code Bestell-Bezeichnung	Stok Stock Lager	Takım Ölçüleri (mm) Dimension (mm) Abmessung (mm)						Kesici Uç Insert Wendeschneidplatte	Yedek Parçaları / Spare Parts / Ersatzteile	
		DC	ZEPF	DCON	LF	LH	APMX		Sıkma Vidası Screw Schraube	Tork Anahtar Torx Key Torx-Schlüssel
AEM90-3P0603-D16-W16-L120-Z03-H	●	16	3	16	120	25	4.7	3PT 0603	3006-M2x4	80-T06
AEM90-3P0603-D20-W20-L150-Z03-H	●	20	3	20	150	25	4.7			
AEM90-3P0603-D25-W25-L150-Z05-H	●	25	5	25	150	25	4.7			
AEM90-3P1004-D20-W20-L150-Z02	●	20	2	20	150	40	7	3PT 1004	1108-M2.5x6	80-T08
AEM90-3P1004-D21-C20-L200-Z02	●	21	2	20	200	30	7			
AEM90-3P1004-D25-W25-L150-Z03	●	25	3	25	150	40	7	3PT 1505	1115-M4x10	80-T15
AEM90-3P1505-D32-W32-L150-Z03	●	32	3	32	150	50	11			
AEM90-3P1505-D40-W32-L150-Z04	●	40	4	32	150	35	11			

R: Sağ / Right / Rechts L: Sol/Left/Links

● Stokta / In Stock / Auf Lager ○ Stokta Yok / Non Stock Item / Kein Lagerartikel, Lieferzeit auf Anfrage

TGTC Ucuna Uygundur. / Compatiple with TGTC Insert. Kompatibel mit TGTC Wendeplatten.

Sipariş Örneği/Ordering Example/Bestellbeispiel

1 ad./pcs./stück AEM90-ZP13T3-D26-C25-L200-Z02

Kesme Hesabı : S 331 / Cutting Calculation : P 331 / Schnittberechnung : 331

➤ **S-SİSTEM YÜZEY PARMAK FREZELER**
S-SYSTEM END MILLS
S-SYSTEM SCHAFTFRÄSER

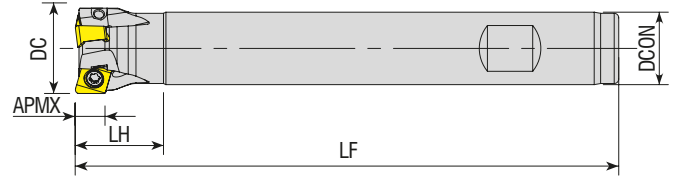

Takım Kodu Ordering Code Bestell-Bezeichnung	Stok Stock Lager	Takım Ölçüleri (mm) Dimension (mm) Abmessung (mm)						Kesici Uç Insert Wendeschneidplatte	Yedek Parçaları / Spare Parts / Ersatzteile		
		DC	ZEFP	DCON	LF	LH	APMX		Sıkma Vidası Screw Schraube	Tork Anahtar Torx Key Torx-Schlüssel	
AEM90-4N06-D16-W16-L120-Z02-H	●	16	2	16	120	25	6	4NKT 0603..	1108-M3x6.8	80-T08	
AEM90-4N06-D16-W16-L160-Z02	●	16	2	16	160	25	6				
AEM90-4N06-D20-W16-L120-Z03-H	●	20	3	16	120	20	6				
AEM90-4N06-D20-W16-L160-Z03	●	20	3	16	160	20	6				

TGTC Ucuna Uygun. / Compatible with TGTC Insert. Kompatibel mit TGTC Wendepplatten.

➤ **S-SİSTEM YÜZEY ve KOPYA PARMAK FREZELER**
S-SYSTEM FACE and COPY END MILLS
S-SYSTEM KOPIER- UND SCHAFTFRÄSER

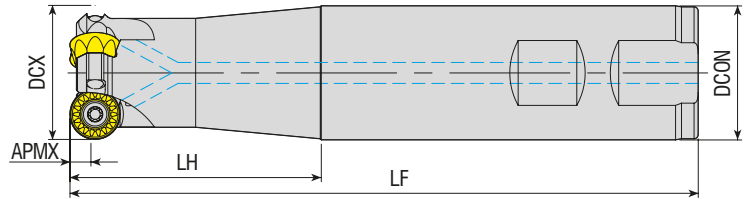

Takım Kodu Ordering Code Bestell-Bezeichnung	Stok Stock Lager	Takım Ölçüleri (mm) Dimension (mm) Abmessung (mm)						Kesici Uç Insert Wendeschneidplatte	Yedek Parçaları / Spare Parts / Ersatzteile			
		DCX	ZEFP	DCON	LF	LH	APMX		Sıkma Vidası Screw Schraube	Baskı Parçası Wedge Clamp Spannpratze	Baskı Vidası Clamp Screw Klemmschraube	Tork Anahtar Torx Key Torx-Schlüssel
AEMR-RP08T2M-D20-W20-L150-Z02-H	●	20	2	20	150	60	4	RPMT 08T2..	3008-M2.5x6	-	-	80-T08
AEMR-RP08T2M-D25-W25-L200-Z03-H	●	25	3	25	200	100	4	RPMT 10T3..	4015-M3.5x9	-	-	80-T15
AEMR-RP10T3M-D25-W25-L200-Z02-H	●	25	2	25	200	100	5	RPMT 1204..	4015-M4x9	-	-	80-T20
AEMR-RP10T3M-D32-W32-L200-Z03-H	●	32	3	32	200	100	5	RPMT 1606..	1020-M5x11	-	-	80-T20
AEMR-RP1204M-D32-W32-L150-Z03-H	●	32	3	32	150	60	6					
AEMR-RP1204M-D32-W32-L200-Z03-H	●	32	3	32	200	100	6					
AEMR-RP1606M-D40-W32-L150-Z02-H	●	40	2	16	150	35	8					
AEMR-RP1606M-D40-W32-L200-Z02-H	●	40	2	16	200	35	8					

R: Sağ / Right / Rechts L: Sol/Left/Links

● Stokta / In Stock / Auf Lager ○ Stokta Yok / Non Stock Item / Kein Lagerartikel, Lieferzeit auf Anfrage
MTSBSH Ucuna Uygun. / Compatible with MTSBSH Insert. Kompatibel mit MTSBSH Wendepplatten.

Sipariş Örneği/Ordering Example/Bestellbeispiel

1 ad./pcs./stück AEMR-4N06-D16-W16-L120-Z02-H

Kesme Hesabı : S 331 / Cutting Calculation : P 331 / Schnittberechnung : 331



www.akkо.com.tr

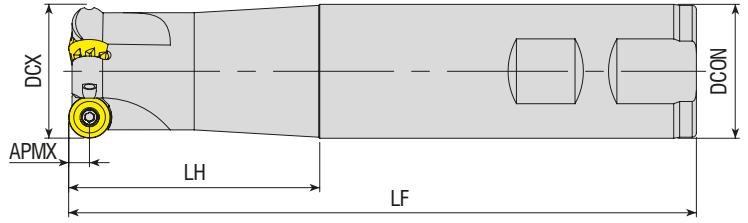

Takım Kodu Ordering Code Bestell-Bezeichnung	Stok Stock Lager	Takım Ölçüleri (mm) Dimension (mm) Abmessung (mm)						Kesici Uç Insert Wendeschneidplatte	Yedek Parçaları / Spare Parts / Ersatzteile			
		DCX	ZEFP	DCON	LF	LH	APMX		Sıkma Vidası Screw Schraube	Baskı Parçası Wedge Clamp Spannpratze	Baskı Vidası Clamp Screw Klemmschraube	Tork Anahtar Torx Key Torx-Schlüssel
AEMR-RP10T3-D25-W25-L125-Z02	●	25	2	25	125	60	5	RPNX 10T3..	4010-M3x8	-	-	80-T10
AEMR-RP10T3-D25-W25-L150-Z02	●	25	2	25	150	60	5					
AEMR-RP10T3-D32-W32-L150-Z03	●	32	3	32	150	60	5					

CRTZT Ucuna Uygun. / Compatible with CRTZT Insert. Kompatibel mit CRTZT Wendeplatten.

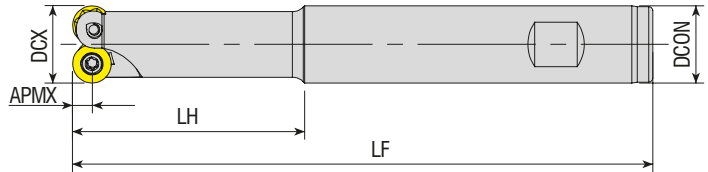

Takım Kodu Ordering Code Bestell-Bezeichnung	Stok Stock Lager	Takım Ölçüleri (mm) Dimension (mm) Abmessung (mm)						Kesici Uç Insert Wendeschneidplatte	Yedek Parçaları / Spare Parts / Ersatzteile	
		DCX	ZEFP	DCON	LF	LH	APMX		Sıkma Vidası Screw Schraube	Tork Anahtar Torx Key Torx-Schlüssel
AEMR-RY08-D16-W16-L150-Z02	●	16	2	16	150	55	4	RYMX 0803..	4010-M3x6	80-T10
AEMR-RY10-D20-W20-L150-Z02	●	20	2	20	150	60	5			
AEMR-RY10-D20-C20-L200-Z02	●	20	2	20	200	100	5			
AEMR-RY10-D21-W20-L200-Z02-H	●	21	2	20	200	30	5	RYMX 1004..	4015-M3.5x8	80-T15
AEMR-RY10-D25-W25-L150-Z02	●	25	2	25	150	60	5			
AEMR-RY10-D25-W25-L150-Z03	●	25	3	25	150	60	5			
AEMR-RY10-D26-W25-L200-Z02-H	●	26	2	25	200	60	5			
AEMR-RY10-D32-W32-L160-Z04-H	●	32	4	32	160	60	5			
AEMR-RY12-D32-C25-L160-Z03	●	32	3	25	160	30	6			

R: Sağ / Right / Rechts L: Sol/Left/Links

● Stokta / In Stock / Auf Lager ○ Stokta Yok / Non Stock Item / Kein Lagerartikel, Lieferzeit auf Anfrage

TGTC Ucuna Uygun. / Compatible with TGTC Insert. Kompatibel mit TGTC Wendeplatten.

Sipariş Örneği/Ordering Example/Bestellbeispiel

1 ad./pcs./stück AEMR-RP10T3-D25-W25-L125-Z02

Kesme Hesabı : S 331 / Cutting Calculation : P 331 / Schnittberechnung : 331

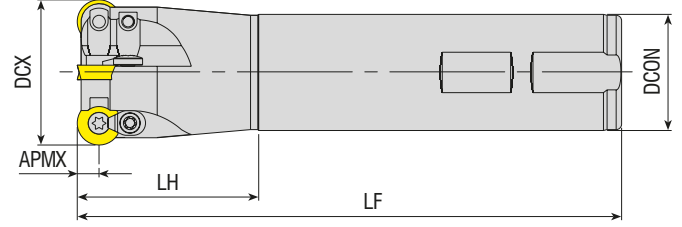

Takım Kodu
Ordering Code
Bestell-Bezeichnung

Stok
Stock
Lager

Takım Ölçüleri (mm)
Dimension (mm)
Abmessung (mm)

Kesici Uç
Insert
Wendeschneidplatte

Yedek Parçaları / Spare Parts / Ersatzteile

Sıkma Vidası
Screw
Schraube

Baskı Parçası
Wedge Clamp
Spannpratze

Baskı Vidası
Clamp Screw
Klemmschraube

Tork Anahtar
Torx Key
Torx-Schlüssel

Takım Kodu Ordering Code Bestell-Bezeichnung	Stok Stock Lager	DCX	ZEFP	DCON	LF	LH	APMX	Kesici Uç Insert Wendeschneidplatte	Sıkma Vidası Screw Schraube	Baskı Parçası Wedge Clamp Spannpratze	Baskı Vidası Clamp Screw Klemmschraube	Tork Anahtar Torx Key Torx-Schlüssel		
AEMR-RD0501-D08-W10-L100-Z01-H	●	8	1	10	100	20	2.5	RD.. 0501	3006-M2x3.6			80-T06		
AEMR-RD0501-D10-W12-L100-Z02-H	●	10	2	12	100	20	2.5		3006-M2x4					
AEMR-RD0501-D12-W12-L120-Z02-H	●	12	2	12	120	20	2.5							
AEMR-RD0803-D16-W16-L150-Z02	●	16	2	16	150	60	4	RD.. 0803	3008-M3x6	-	-	80-T08		
AEMR-RD0803-D16-C20-L200-Z02	●	16	2	20	200	60	4							
AEMR-RD0803-D20-W20-L150-Z03	●	20	3	20	150	60	4							
AEMR-RD08T2-D16-W16-L150-Z02	●	16	2	16	150	60	4	RD.. 08T2	3008-M2.5x6					
AEMR-RD08T2-D20-W20-L150-Z02	●	20	2	20	150	60	4							
AEMRC-RD1003-D20-W20-L150-Z02	●	20	2	20	150	60	5	RD.. 1003						
AEMRC-RD1003-D20-C20-L160-Z02	●	20	2	20	160	70	5							
AEMRC-RD1003-D20-C20-L250-Z02	●	20	2	20	250	150	5							
AEMRC-RD1003-D21-C20-L160-Z02	●	21	2	20	160	70	5							
AEMRC-RD1003-D25-W25-L150-Z02	●	25	2	25	150	60	5							
AEMRC-RD1003-D25-C25-L160-Z02	●	25	2	25	160	70	5							
AEMRC-RD1003-D25-W25-L200-Z02	●	25	2	25	200	100	5							
AEMRC-RD1003-D25-C25-L200-Z02	●	25	2	25	200	100	5							
AEMRC-RD1003-D25-C25-L250-Z02	●	25	2	25	250	150	5							
AEMRC-RD1003-D26-C25-L160-Z02	●	26	2	25	160	70	5							
AEMRC-RD1003-D32-W32-L150-Z03	●	32	3	32	150	60	5							
AEMRC-RD1003-D32-C32-L250-Z02	●	32	2	32	250	150	5							
AEMRC-RD1003-D33-C32-L160-Z03	●	33	3	32	160	70	5							
AEMRC-RD1003-D40-W32-L150-Z04	●	40	4	32	150	35	5							
AEMRC-RD1003-D40-C32-L250-Z02	●	40	2	32	250	50	5							
AEMRC-RD10T3-D20-C20-L150-Z02	●	20	2	20	150	60	5		RD.. 10T3	4015-M3.5x9	ACK-15		4015-M3.5x11	80-T15
AEMRC-RD10T3-D20-W20-L150-Z02	●	20	2	20	150	60	5							
AEMRC-RD10T3-D25-C25-L150-Z02	●	25	2	25	150	60	5							
AEMRC-RD10T3-D25-W25-L150-Z02	●	25	2	25	150	60	5							
AEMRC-RD10T3-D32-W32-L150-Z03	●	32	3	32	150	60	5							
AEMRC-RD12T3-D25-W25-L150-Z02	●	25	2	25	150	60	6	RD.. 12T3						
AEMRC-RD12T3-D25-W25-L200-Z02	●	25	2	25	200	100	6							
AEMRC-RD12T3-D25-C25-L250-Z02	●	25	2	25	250	150	6							
AEMRC-RD12T3-D25-C25-L300-Z02	●	25	2	25	300	200	6							
AEMRC-RD12T3-D32-W32-L150-Z03	●	32	3	32	150	60	6							
AEMRC-RD12T3-D32-C32-L250-Z02	●	32	2	32	250	150	6							
AEMRC-RD12T3-D40-W32-L150-Z04	●	40	4	32	150	50	6							
AEMRC-RD12T3-D40-C32-L250-Z02	●	40	2	32	250	50	6							
AEMRC-RD1204-D32-C32-L160-Z03	●	32	3	32	160	70	6	RD.. 1204						
AEMRC-RD1204-D32-W32-L160-Z03	●	32	3	32	160	50	6							
AEMRC-RD1204-D33-C32-L160-Z03	●	33	3	32	160	70	6							
AEMRC-RD1604-D40-W32-L150-Z02	●	40	2	32	150	35	8	RD.. 1604	4015-M4.5x11	ACK-05	4015-M4x11			

R: Sağ / Right / Rechts L: Sol/Left/Links

● Stokta / In Stock / Auf Lager ○ Stokta Yok / Non Stock Item / Kein Lagerartikel, Lieferzeit auf Anfrage
ISO Uçuna Uygundur. / Compatible with ISO Insert. Kompatibel mit ISO Wendepplatten.

Sipariş Örneği/Ordering Example/Bestellbeispiel

1 ad./pcs./stück AEMR-RD0501-D08-W10-L100-Z01-H

Kesme Hesabı : S 331 / Cutting Calculation : P 331 / Schnittberechnung : 331



www.akkо.com.tr

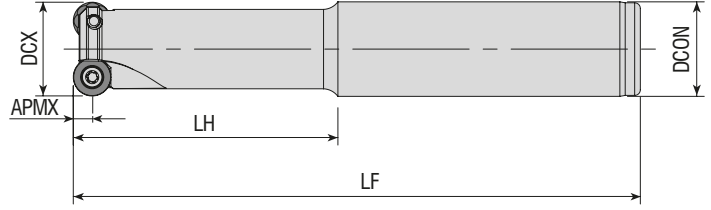

Takım Kodu
Ordering Code
Bestell-Bezeichnung

Takım Kodu Ordering Code Bestell-Bezeichnung	Stok Stock Lager	Takım Ölçüleri (mm) Dimension (mm) Abmessung (mm)						Kesici Uç Insert Wendeschneidplatte	Yedek Parçaları / Spare Parts / Ersatzteile			
		DCX	ZEFP	DCON	LF	LH	APMX		Sıkma Vidası Screw Schraube	Baskı Parçası Wedge Clamp Spannpratze	Baskı Vidası Clamp Screw Klemmschraube	Tork Anahtar Torx Key Torx-Schlüssel
AEMR-QP10T3-D20-C20-L150-Z01-H	●	20	1	20	150	70	5	QP.. 10T3..	4015-M3.5x9	-	-	80-T15
AEMR-QP10T3-D25-C25-L120-Z02-H	●	25	2	25	120	40	5					
AEMR-QP10T3-D25-C25-L150-Z02-H	●	25	2	25	150	70	5					
AEMR-QP10T3-D25-C25-L170-Z02	●	25	2	25	170	90	5					
AEMR-QP10T3-D32-C32-L150-Z03-H	●	32	3	32	150	70	5					
AEMR-QP10T3-D32-C32-L170-Z03	●	32	3	32	170	90	5					
AEMR-QP1204-D25-C25-L150-Z02-H	●	25	2	25	150	70	6	QP.. 1204..	4015-M4x9	-	-	

SMTM Ucuna Uygun. / Compatible with SMTM Insert. Kompatibel mit SMTM Wendeplatten.

S-SİSTEM HIZLI İLERLEMELİ PARMAK FREZELER
S-SYSTEM HIGHFEED END MILLS
S-SYSTEM HOCHVORSCHUB- SCHAFTFRÄSER

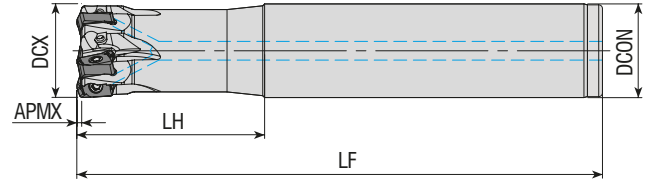

Takım Kodu
Ordering Code
Bestell-Bezeichnung

Takım Kodu Ordering Code Bestell-Bezeichnung	Stok Stock Lager	Takım Ölçüleri (mm) Dimension (mm) Abmessung (mm)						Kesici Uç Insert Wendeschneidplatte	Yedek Parçaları / Spare Parts / Ersatzteile	
		DCX	ZEFP	DCON	LF	LH	APMX		Sıkma Vidası Screw Schraube	Tork Anahtar Torx Key Torx-Schlüssel
AHFM-BN10T3-D16-C16-L100-Z02-H	●	16	2	16	100	30	1	BNGX 10T3..	3008-M2.5x6	80-T08
AHFM-BN10T3-D16-C16-L150-Z02-H	●	16	2	16	150	50	1			
AHFM-BN10T3-D20-C20-L130-Z03-H	●	20	3	20	130	40	1			
AHFM-BN10T3-D20-C20-L130-Z04-H	●	20	4	20	130	40	1			
AHFM-BN10T3-D20-C20-L160-Z03-H	●	20	3	20	160	80	1			
AHFM-BN10T3-D25-C25-L140-Z04-H	●	25	4	25	140	50	1			
AHFM-BN10T3-D25-W25-L140-Z04-H	●	25	4	25	140	50	1			
AHFM-BN10T3-D25-C25-L140-Z05-H	●	25	5	25	140	50	1			
AHFM-BN10T3-D25-C25-L180-Z04-H	●	25	4	25	180	100	1			
AHFM-BN10T3-D32-C32-L150-Z05-H	●	32	5	32	150	70	1			
AHFM-BN10T3-D32-C32-L150-Z06-H	●	32	6	32	150	70	1			
AHFM-BN10T3-D35-C32-L200-Z06-H	●	35	6	32	200	50	1			

R: Sağ / Right / Rechts L: Sol/Left/Links

● Stokta / In Stock / Auf Lager ○ Stokta Yok / Non Stock Item / Kein Lagerartikel, Lieferzeit auf Anfrage

PRMT Ucuna Uygun. / Compatible with PRMT Insert. Kompatibel mit PRMT Wendeplatten.

Sipariş Örneği/Ordering Example/Bestellbeispiel

1 ad./pcs./stück AHFM-QP10T3-D20-C20-L150-Z01-H

Kesme Hesabı : S 331 / Cutting Calculation : P 331 / Schnittberechnung : 331

S-SİSTEM HIZLI İLERLEMELİ PARMAK FREZELER
S-SYSTEM HIGHFEED END MILLS
S-SYSTEM HOCHVORSCHUB- SCHAFTFRÄSER

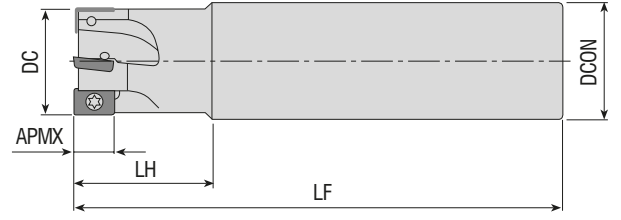

Takım Kodu Ordering Code Bestell-Bezeichnung	Stok Stock Lager	Takım Ölçüleri (mm) Dimension (mm) Abmessung (mm)						Kesici Uç Insert Wendeschneidplatte	Yedek Parçaları / Spare Parts / Ersatzteile	
		DC	ZEFP	DCON	LF	LH	APMX		Sıkma Vidası Screw Schraube	Tork Anahtar Torx Key Torx-Schlüssel
AHFM-E00602-D10-C10-L080-Z02	●	10	2	10	80	20	-	EO.. 0602.. ZOMT 0602..	3006-M1.8x4	80-T06
AHFM-E00602-D10-C09-L120-Z02	●	10	2	9	120	15	-			
AHFM-E00602-D10-C10-L120-Z02	●	10	2	10	120	60	-			
AHFM-E00602-D12-C12-L080-Z02	●	12	2	12	80	20	-			
AHFM-E00602-D12-C12-L080-Z03	●	12	3	12	80	20	-			
AHFM-E00602-D12-C11-L120-Z02	●	12	2	11	120	15	-			
AHFM-E00602-D12-C11-L120-Z03	●	12	3	11	120	15	-			
AHFM-E00602-D12-C12-L120-Z02	●	12	2	12	120	60	-			
AHFM-E00602-D12-C12-L120-Z03	●	12	3	12	120	60	-			
AHFM-E00602-D16-C16-L150-Z04	●	16	4	16	150	60	-			

DJT Ucuna Uygundur. / Compatible with DJT Insert. Kompatibel mit DJT Wendepplatten.

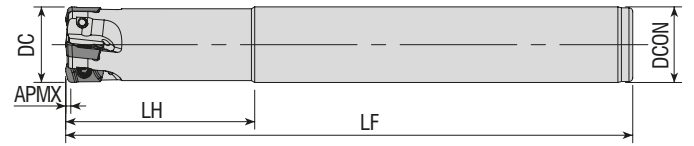

Takım Kodu Ordering Code Bestell-Bezeichnung	Stok Stock Lager	Takım Ölçüleri (mm) Dimension (mm) Abmessung (mm)						Kesici Uç Insert Wendeschneidplatte	Yedek Parçaları / Spare Parts / Ersatzteile	
		DC	ZEFP	DCON	LF	LH	APMX		Sıkma Vidası Screw Schraube	Tork Anahtar Torx Key Torx-Schlüssel
AHFM-EP1003-D16-C16-L150-Z02-H	●	16	2	16	150	50	1	EP.. 1003.. ZPMT 1003.. YPHW 1003..	3008-M2.5x5	80-T08
AHFM-EP1003-D17-C16-L150-Z02-H	●	17	2	16	150	20	1			
AHFM-EP1003-D20-C20-L150-Z04-H	●	20	4	20	150	50	1			
AHFM-EP1003-D21-C20-L150-Z04-H	●	21	4	20	150	20	1			

R: Sağ / Right / Rechts L: Sol/Left/Links

● Stokta / In Stock / Auf Lager ○ Stokta Yok / Non Stock Item / Kein Lagerartikel, Lieferzeit auf Anfrage
 DJT Ucuna Uygundur. / Compatible with DJT Insert. Kompatibel mit DJT Wendepplatten.

Sipariş Örneği/Ordering Example/Bestellbeispiel

1 ad./pcs./stück AHFM-E00602-D10-C10-L080-Z02

Kesme Hesabı : S 331 / Cutting Calculation : P 331 / Schnittberechnung : 331



www.akko.com.tr

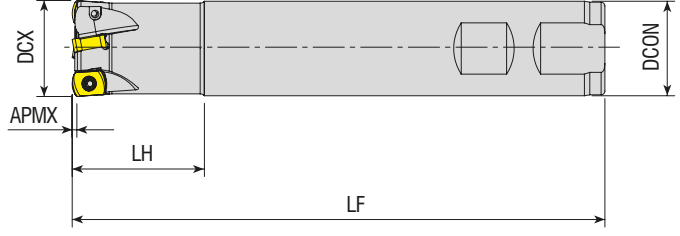

Takım Kodu Ordering Code Bestell-Bezeichnung	Stok Stock Lager	Takım Ölçüleri (mm) Dimension (mm) Abmessung (mm)						Kesici Uç Insert Wendeschneidplatte	Yedek Parçaları / Spare Parts / Ersatzteile		
		DCX	ZEPF	DCON	LF	LH	APMX		Sıkma Vidası Screw Schraube	Tork Anahtar Torx Key Torx-Schlüssel	
AHFM-BL0603-D16-C15-L150-Z02	●	16	2	15	150	20	1	BLMP 0603..	3008-M2.5x6	80-T08	
AHFM-BL0603-D16-C16-L100-Z02-H	●	16	2	16	100	30	1				
AHFM-BL0603-D16-C16-L150-Z02	●	16	2	16	150	50	1				
AHFM-BL0603-D17-C16-L150-Z02	●	17	2	16	170	20	1				
AHFM-BL0603-D17-W16-L170-Z02	●	17	2	16	170	20	1				
AHFM-BL0603-D17-W16-L170-Z02-H	●	17	2	16	170	20	1				
AHFM-BL0603-D17-C16-L200-Z02	●	17	2	16	200	30	1				
AHFM-BL0603-D18-C16-L150-Z02	●	18	2	16	150	20	1				
AHFM-BL0603-D18-W16-L150-Z02-H	●	18	2	16	150	20	1				
AHFM-BL0603-D20-C20-L130-Z03	●	20	3	20	130	50	1				
AHFM-BL0603-D20-C20-L160-Z03	●	20	3	20	160	50	1				
AHFM-BL0603-D21-C20-L200-Z03	●	21	3	20	200	25	1				
AHFM-BL0603-D21-W20-L200-Z03	●	21	3	20	200	25	1				
AHFM-BL0603-D22-W20-L150-Z03	●	22	3	20	150	20	1				
AHFM-BL0603-D25-C25-L250-Z04	●	25	4	25	250	40	1				
AHFM-BL0603-D26-C25-L200-Z04	●	26	4	25	200	35	1				
AHFM-BL0603-D26-W25-L200-Z04	●	26	4	25	200	35	1				
AHFM-BL0603-D26-C25-L250-Z04	●	26	4	25	250	35	1				
AHFM-BL0603-D32-C32-L150-Z05	●	32	5	32	150	70	1				
AHFM-BL0603-D32-C32-L200-Z05	●	32	5	32	200	120	1				
AHFM-BL0603-D33-C32-L200-Z05	●	33	5	32	200	40	1				
AHFM-BL0603-D33-C32-L250-Z05	●	33	5	32	250	40	1				

R: Sağ / Right / Rechts L: Sol/Left/Links

● Stokta / In Stock / Auf Lager ○ Stokta Yok / Non Stock Item / Kein Lagerartikel, Lieferzeit auf Anfrage

TGTC Ucuna Uygun. / Compatible with TGTC Insert. Kompatibel mit TGTC Wendeplatten.

Sipariş Örneği/Ordering Example/Bestellbeispiel

1 ad./pcs./stück AHFM-BL0603-D16-C15-L150-Z02

Kesme Hesabı : S 331 / Cutting Calculation : P 331 / Schnittberechnung : 331

S-SİSTEM HIZLI İLERLEMELİ PARMAK FREZELER
S-SYSTEM HIGHFEED END MILLS
S-SYSTEM HOCHVORSCHUB- SCHAFTFRÄSER

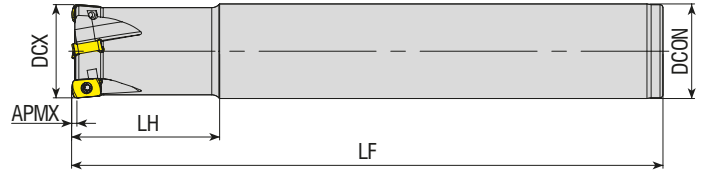

Takım Kodu Ordering Code Bestell-Bezeichnung	Stok Stock Lager	Takım Ölçüleri (mm) Dimension (mm) Abmessung (mm)						Kesici Uç Insert Wendeschneidplatte	Yedek Parçaları / Spare Parts / Ersatzteile	
		DCX	ZEPF	DCON	LF	LH	APMX		Sıkma Vidası Screw Schraube	Tork Anahtar Torx Key Torx-Schlüssel
AHFM-EN1004-D16-C15-L150-Z02	●	16	2	15	150	25	1	ENMU 1004..	3008-M2.5x5	80-T08
AHFM-EN1004-D16-C16-L150-Z02	●	16	2	16	150	25	1			
AHFM-EN1004-D17-C16-L150-Z02-H	●	17	2	16	150	25	1			
AHFM-EN1004-D17-C16-L150-Z02	●	17	2	16	150	25	1			
AHFM-EN1004-D17-C16-L200-Z02	●	17	2	16	200	25	1			
AHFM-EN1004-D18-C16-L150-Z02	●	18	2	16	150	25	1			
AHFM-EN1004-D20-C20-L150-Z03	●	20	3	20	150	40	1			
AHFM-EN1004-D21-C20-L150-Z02	●	21	2	20	150	30	1			
AHFM-EN1004-D21-C20-L150-Z03	●	21	3	20	150	30	1			
AHFM-EN1004-D21-C20-L200-Z03	●	21	3	20	200	30	1			
AHFM-EN1004-D22-C20-L150-Z03	●	22	3	20	150	30	1			
AHFM-EN1004-D25-C25-L150-Z03	●	25	3	25	150	40	1			
AHFM-EN1004-D25-C25-L150-Z04	●	25	4	25	150	40	1			
AHFM-EN1004-D26-C25-L150-Z03	●	26	3	25	150	30	1			
AHFM-EN1004-D26-C25-L150-Z04	●	26	4	25	150	30	1			
AHFM-EN1004-D26-C25-L200-Z03	●	26	3	25	150	30	1			
AHFM-EN1004-D26-C25-L200-Z03-H	●	26	3	25	200	30	1			
AHFM-EN1004-D26-C25-L250-Z03-H	●	26	3	25	250	30	1			
AHFM-EN1004-D28-C25-L200-Z04	●	28	4	25	200	30	1			
AHFM-EN1004-D32-C32-L200-Z04	●	32	4	32	200	50	1			
AHFM-EN1004-D33-C32-L200-Z04	●	33	4	32	200	30	1			
									3008-M2.5x6	

R: Sağ / Right / Rechts L: Sol/Left/Links

● Stokta / In Stock / Auf Lager ○ Stokta Yok / Non Stock Item / Kein Lagerartikel, Lieferzeit auf Anfrage
 DJT Ucuna Uygundur. / Compatiple with DJT Insert. Kompatibel mit DJT Wendeplatten.

Sipariş Örneği/Ordering Example/ Bestellbeispiel

1 ad./pcs./stück AHFM-EN1004-D16-C15-L150-Z02

Kesme Hesabı : S 331 / Cutting Calculation : P 331 / Schnittberechnung : 331



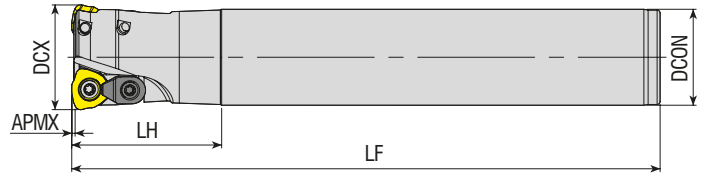

Takım Kodu Ordering Code Bestell-Bezeichnung	Stok Stock Lager	Takım Ölçüleri (mm) Dimension (mm) Abmessung (mm)						Kesici Uç Insert Wendeschneidplatte	Yedek Parçaları / Spare Parts / Ersatzteile			
		DCX	ZEFP	DCON	LF	LH	APMX		Sıkma Vidası Screw Schraube	Baskı Parçası Wedge Clamp Spannpratze	Baskı Vidası Clamp Screw Klemmschraube	Tork Anahtar Torx Key Torx-Schlüssel
AHFMC-JD1204-D32-C32-L150-Z02	●	32	2	32	150	50	1	JDMW 1204..	4615-M4x11	ACK-05	4015-M4x11	80-T15
AHFMC-JD1204-D32-C32-L200-Z02	●	32	2	32	200	50	1					
AHFMC-JD1204-D35-C32-L200-Z02	●	35	2	32	200	50	1					
AHFMC-JD1204-D35-C32-L250-Z02	●	35	2	32	250	50	1					

MTSBH Ucuna Uygunur. / Compatiple with MTSBHInsert. Kompatibel mit MTSBH Wendeplatten.

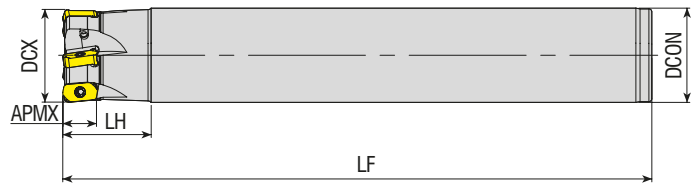

Takım Kodu Ordering Code Bestell-Bezeichnung	Stok Stock Lager	Takım Ölçüleri (mm) Dimension (mm) Abmessung (mm)						Kesici Uç Insert Wendeschneidplatte	Yedek Parçaları / Spare Parts / Ersatzteile		
		DCX	ZEFP	DCON	LF	LH	APMX		Sıkma Vidası Screw Schraube	Tork Anahtar Torx Key Torx-Schlüssel	
AHFM-LN120-D16-C15-L150-Z02	●	16	2	15	150	30	12	LNMX 1235..	3008-M2.5x6	80-T08	
AHFM-LN120-D21-C20-L150-Z03	●	21	3	20	150	30	12				
AHFM-LN120-D26-C25-L150-Z04	●	26	4	25	150	30	12				
AHFM-LN120-D33-C32-L200-Z05	●	33	5	32	200	30	12				

R: Sağ / Right / Rechts L: Sol/Left/Links

● Stokta / In Stock / Auf Lager ○ Stokta Yok / Non Stock Item / Kein Lagerartikel, Lieferzeit auf Anfrage
B.OKE Ucuna Uygunur. / Compatiple with B.OKE Insert. Kompatibel mit B.OKE Wendeplatten.

Sipariş Örneği/Ordering Example/Bestellbeispiel

1 ad./pcs./stück AHFM-JD1204-D32-C32-L150-Z02

Kesme Hesabı : S 331 / Cutting Calculation : P 331 / Schnittberechnung : 331

S-SİSTEM HIZLI İLERLEMELİ PARMAK FREZELER
S-SYSTEM HIGHFEED END MILLS
S-SYSTEM HOCHVORSCHUB- SCHAFTFRÄSER

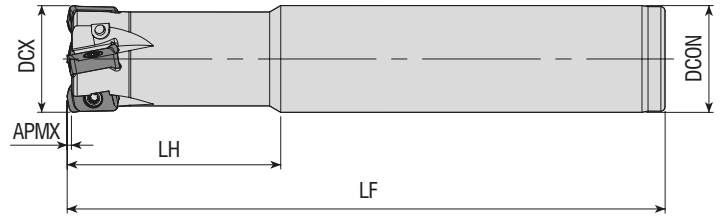

Takım Kodu Ordering Code Bestell-Bezeichnung	Stok Stock Lager	Takım Ölçüleri (mm) Dimension (mm) Abmessung (mm)						Kesici Uç Insert Wendeschneidplatte	Yedek Parçaları / Spare Parts / Ersatzteile		
		DCX	ZEFP	DCON	LF	LH	APMX		Sıkma Vidası Screw Schraube	Tork Anahtar Torx Key Torx-Schlüssel	
AHFM-L003-D16-C15-L160-Z02	●	16	2	15	160	30	1	LOGU 0303..	1108-M3x6.8	80-T08	
AHFM-L003-D16-C16-L100-Z02-F	●	16	2	16	100	30	1				
AHFM-L003-D16-C16-L100-Z02	●	16	2	16	100	30	1				
AHFM-L003-D16-C16-L130-Z02-H	●	16	2	16	130	40	1				
AHFM-L003-D16-C16-L160-Z02	●	16	2	16	160	50	1				
AHFM-L003-D16-C16-L160-Z02-H	●	16	2	16	160	100	1				
AHFM-L003-D17-C16-L180-Z02	●	17	2	16	180	30	1				
AHFM-L003-D20-C20-L130-Z03	●	20	3	20	130	40	1				
AHFM-L003-D20-C20-L130-Z03-H	●	20	3	20	130	40	1				
AHFM-L003-D20-C20-L160-Z03	●	20	3	20	160	80	1				
AHFM-L003-D20-C20-L160-Z03-H	●	20	3	20	160	100	1				
AHFM-L003-D21-C20-L200-Z03	●	21	3	20	200	30	1				
AHFM-L003-D25-C25-L140-Z04-F	●	25	4	25	140	50	1				
AHFM-L003-D25-C25-L140-Z04	●	25	4	25	140	50	1				
AHFM-L003-D25-C25-L180-Z04	●	25	4	25	180	100	1				
AHFM-L003-D26-C25-L250-Z04	●	26	4	25	250	40	1				
AHFM-L003-D32-C32-L200-Z05	●	32	5	32	200	120	1				
AHFM-L003-D33-C32-L250-Z05	●	33	5	32	250	40	1				

R: Sağ / Right / Rechts L: Sol/Left/Links

● Stokta / In Stock / Auf Lager ○ Stokta Yok / Non Stock Item / Kein Lagerartikel, Lieferzeit auf Anfrage
 KYCR Ucuna Uygunudur. / Compatible with KYCR Insert. Kompatibel mit KYCR Wendeplatten.

Sipariş Örneği/Ordering Example/Bestellbeispiel

1 ad./pcs./stück AHFM-L003-D16-C15-L160-Z02

Kesme Hesabı : S 331 / Cutting Calculation : P 331 / Schnittberechnung : 331

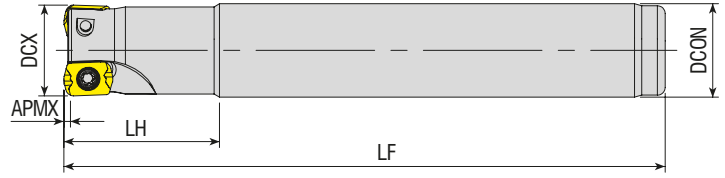

Takım Kodu Ordering Code Bestell-Bezeichnung	Stok Stock Lager	Takım Ölçüleri (mm) Dimension (mm) Abmessung (mm)						Kesici Uç Insert Wendeschneidplatte	Yedek Parçaları / Spare Parts / Ersatzteile		
		DCX	ZEPF	DCON	LF	LH	APMX		Sıkma Vidası Screw Schraube	Tork Anahtar Torx Key Torx-Schlüssel	
AHFM-LP0102-D10-C09-L120-Z02	●	10	2	9	120	20	0.5	LPGT 0102..	3006-M1.8x4	80-T06	
AHFM-LP0102-D10-C10-L120-Z02	●	10	2	10	120	20	0.5				
AHFM-LP0102-D12-C11-L120-Z02	●	12	2	11	120	20	0.5				
AHFM-LP0102-D12-C12-L120-Z02	●	12	2	12	120	20	0.5				

KYCR Ucuna Uygun. / Compatible with KYCR Insert. Kompatibel mit KYCR Wendeplatten.

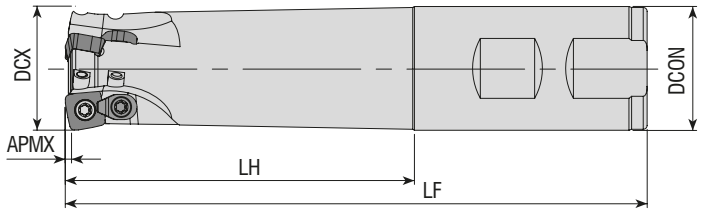

Takım Kodu Ordering Code Bestell-Bezeichnung	Stok Stock Lager	Takım Ölçüleri (mm) Dimension (mm) Abmessung (mm)						Kesici Uç Insert Wendeschneidplatte	Yedek Parçaları / Spare Parts / Ersatzteile				
		DCX	ZEPF	DCON	LF	LH	APMX		Sıkma Vidası Screw Schraube	Baskı Parçası Wedge Clamp Spannpratze	Baskı Vidası Clamp Screw Klemmschraube	Tork Anahtar Torx Key Torx-Schlüssel	
AHFM-SD06T2-D16-C16-L100-Z02-H	●	16	2	16	100	50	0.8	SD.. 06T2..	3007-M2.2x5	-	-	80-T07	
AHFM-SD06T2-D16-C16-L150-Z02-H	●	16	2	16	150	50	0.8						
AHFM-SD06T2-D16-C16-L200-Z02	●	16	2	16	200	100	0.8						
AHFM-SD06T2-D17-C16-L150-Z02-H	●	17	2	16	150	50	0.8						
AHFM-SD06T2-D20-C20-L150-Z03-H	●	20	3	20	150	50	0.8						
AHFM-SD06T2-D20-C20-L200-Z03	●	20	3	20	200	100	0.8						
AHFM-SD06T2-D21-C20-L150-Z03-H	●	21	3	20	150	50	0.8						
AHFM-SD06T2-D25-C25-L150-Z04-H	●	25	4	25	150	60	0.8						
AHFM-SD06T2-D26-C25-L150-Z04-H	●	26	4	25	150	60	0.8						
AHFM-SD09T3-D22-W20-L150-Z02	●	22	2	20	150	30	1.4						SD.. 09T3..
AHFM-SD09T3-D25-C25-L150-Z02	●	25	2	25	150	94	1.4						
AHFM-SD09T3-D25-W25-L150-Z02	●	25	2	25	150	94	1.4						
AHFM-SD09T3-D28-C25-L150-Z02	●	28	2	25	150	30	1.4						
AHFM-SD09T3-D32-C32-L150-Z03	●	32	3	32	150	100	1.4						
AHFM-SD09T3-D32-W32-L150-Z03	●	32	3	32	150	90	1.4						
AHFM-SD09T3-D25-C25-L150-Z03	●	25	3	25	150	60	1.4						
AHFM-SD09T3-D32-C32-L150-Z04	●	32	4	25	150	60	1.4						

R: Sağ / Right / Rechts L: Sol/Left/Links

● Stokta / In Stock / Auf Lager ○ Stokta Yok / Non Stock Item / Kein Lagerartikel, Lieferzeit auf Anfrage
ZCC Ucuna Uygun. / Compatible with ZCC Insert. Kompatibel mit ZCC Wendeplatten.

Sipariş Örneği/Ordering Example/Bestellbeispiel

1 ad./pcs./stück AHFM-LP0102-D10-C09-L120-Z02

Kesme Hesabı : S 331 / Cutting Calculation : P 331 / Schnittberechnung : 331

S-SİSTEM HIZLI İLERLEMELİ PARMAK FREZELER
S-SYSTEM HIGHFEED END MILLS
S-SYSTEM HOCHVORSCHUB- SCHAFTFRÄSER

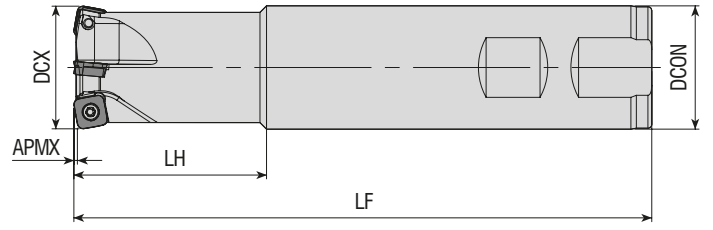

Takım Kodu Ordering Code Bestell-Bezeichnung	Stok Stock Lager	Takım Ölçüleri (mm) Dimension (mm) Abmessung (mm)						Kesici Uç Insert Wendeschneidplatte	Yedek Parçaları / Spare Parts / Ersatzteile		
		DCX	ZEFP	DCON	LF	LH	APMX		Sıkma Vidası Screw Schraube	Tork Anahtar Torx Key Torx-Schlüssel	
AHFM-S00803-D20-W20-L150-Z02	●	20	2	20	150	50	-	SOMW 0803..	4010-M3x8	80-T10	
AHFM-S00803-D25-W25-L150-Z03	●	25	3	25	150	50	-				
AHFM-S00803-D32-W32-L150-Z04	●	32	4	32	150	50	-				

KPTK Ucuna Uygunur. / Compatible with KPTK Insert. Kompatibel mit KPTK Wendepplatten.

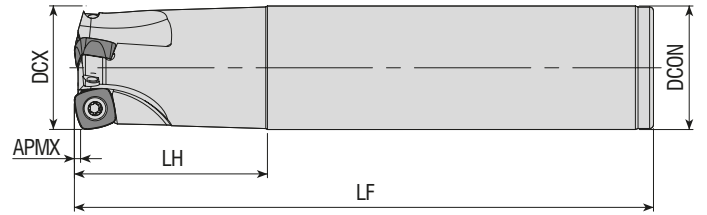

Takım Kodu Ordering Code Bestell-Bezeichnung	Stok Stock Lager	Takım Ölçüleri (mm) Dimension (mm) Abmessung (mm)						Kesici Uç Insert Wendeschneidplatte	Yedek Parçaları / Spare Parts / Ersatzteile		
		DCX	ZEFP	DCON	LF	LH	APMX		Sıkma Vidası Screw Schraube	Tork Anahtar Torx Key Torx-Schlüssel	
AHFM-SP1004-D25-C25-L150-Z02	●	25	2	25	150	50	1.5	SPNW 1004..	3015-M3.5x9	80-T15	
AHFM-SP1004-D32-C32-L150-Z03	●	32	3	32	150	50	1.5				

R: Sağ / Right / Rechts L: Sol/Left/Links



● Stokta / In Stock / Auf Lager ○ Stokta Yok / Non Stock Item / Kein Lagerartikel, Lieferzeit auf Anfrage
 DJT Ucuna Uygunur. / Compatible with DJT Insert. Kompatibel mit DJT Wendepplatten.

Sipariş Örneği/Ordering Example/Bestellbeispiel

1 ad./pcs./stück AHFM-S00803-D20-W20-L150-Z02

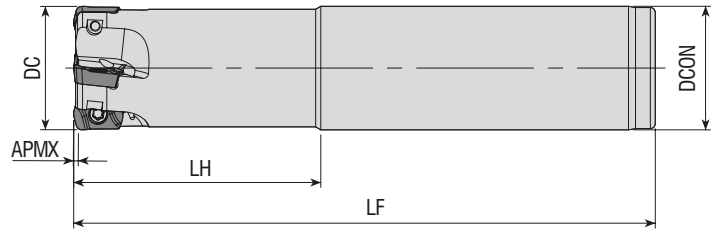
Kesme Hesabı : S 331 / Cutting Calculation : P 331 / Schnittberechnung : 331

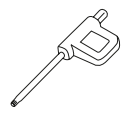

Takım Kodu Ordering Code Bestell-Bezeichnung	Stok Stock Lager	Takım Ölçüleri (mm) Dimension (mm) Abmessung (mm)						Kesici Uç Insert Wendeschneidplatte	Yedek Parçaları / Spare Parts / Ersatzteile	
		DC	ZEPF	DCON	LF	LH	APMX		Sıkma Vidası Screw Schraube	Tork Anahtar Torx Key Torx-Schlüssel
AHFM-YP1003-D16-C15-L150-Z02-F	●	16	2	15	150	20	1	 EP. 1003.. YPHW 1003.. ZPMT 1003..	 3008-M2.5x5	 80-T08
AHFM-YP1003-D16-C15-L200-Z02-F	●	16	2	15	200	20	1			
AHFM-YP1003-D16-C16-L150-Z02-F	●	16	2	16	150	50	1			
AHFM-YP1003-D17-C16-L150-Z02-F	●	17	2	16	150	20	1			
AHFM-YP1003-D17-C16-L200-Z02-F	●	17	2	16	200	20	1			
AHFM-YP1003-D20-C18-L150-Z03-F	●	20	3	18	150	25	1			
AHFM-YP1003-D20-C18-L200-Z03-F	●	20	3	18	200	25	1			
AHFM-YP1003-D20-C20-L150-Z03-F	●	20	3	20	150	50	1			
AHFM-YP1003-D21-C20-L150-Z03-F	●	21	3	20	150	20	1			
AHFM-YP1003-D21-C20-L150-Z03-H	●	21	3	20	150	20	1			
AHFM-YP1003-D21-C20-L150-Z04-F	●	21	4	20	150	20	1			
AHFM-YP1003-D21-C20-L200-Z03	●	21	3	20	200	20	1			
AHFM-YP1003-D21-C20-L200-Z03-F	●	21	3	20	200	20	1			
AHFM-YP1003-D25-C20-L150-Z04-F	●	25	4	20	150	25	1			
AHFM-YP1003-D25-C20-L200-Z04-F	●	25	4	20	200	25	1			
AHFM-YP1003-D25-C25-L150-Z04-F	●	25	4	25	150	50	1			
AHFM-YP1003-D26-C25-L150-Z04	●	26	4	25	150	30	1			
AHFM-YP1003-D26-C25-L150-Z04-F	●	26	4	25	150	30	1			
AHFM-YP1003-D26-C25-L200-Z03-F	●	26	3	25	200	30	1			
AHFM-YP1003-D26-C25-L200-Z04-F	●	26	4	25	200	30	1			

R: Sağ / Right / Rechts L: Sol/Left/Links

● Stokta / In Stock / Auf Lager ○ Stokta Yok / Non Stock Item / Kein Lagerartikel, Lieferzeit auf Anfrage
DJT Ucuna Uygunudur. / Compatible with DJT Insert. Kompatibel mit DJT Wendepplatten.

Sipariş Örneği/Ordering Example/Bestellbeispiel

1 ad./pcs./stück AHFM-YP1003-D16-C15-L150-Z02-F

Kesme Hesabı : S 331 / Cutting Calculation : P 331 / Schnittberechnung : 331



S-SİSTEM HIZLI İLERLEMELİ PARMAK FREZELER

S-SYSTEM HIGHFEED END MILLS

S-SYSTEM HOCHVORSCHUB- SCHAFTFRÄSER

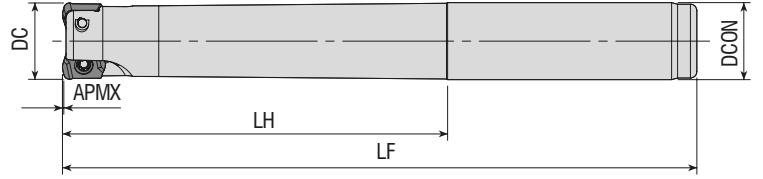

Takım Kodu Ordering Code Bestell-Bezeichnung	Stok Stock Lager	Takım Ölçüleri (mm) Dimension (mm) Abmessung (mm)						Kesici Uç Insert Wendeschneidplatte	Yedek Parçaları / Spare Parts / Ersatzteile		
		DC	ZEPF	DCON	LF	LH	APMX		Sıkma Vidası Screw Schraube	Tork Anahtar Torx Key Torx-Schlüssel	
AHFM-YO0602-D10-C09-L120-Z02-F	●	10	2	9	120	15	0.3	YOHW 0602..	3006-M1.8X4	80-T06	
AHFM-YO0602-D10-C10-L080-Z02-F	●	10	2	10	80	20	0.3				
AHFM-YO0602-D10-C10-L120-Z02-F	●	10	2	10	120	60	0.3				
AHFM-YO0602-D10-C10-L120-Z02-H-F	●	10	2	10	120	60	0.3				
AHFM-YO0602-D10-C10-L120-Z02-H	●	10	2	10	120	60	0.3				
AHFM-YO0602-D12-C11-L120-Z02-F	●	12	2	11	120	15	0.3				
AHFM-YO0602-D12-C11-L120-Z02-H-F	●	12	2	11	120	15	0.3				
AHFM-YO0602-D12-C11-L120-Z02-H	●	12	2	11	120	15	0.3				
AHFM-YO0602-D12-C11-L120-Z03-F	●	12	3	11	120	15	0.3				
AHFM-YO0602-D12-C12-L080-Z02-F	●	12	2	12	80	20	0.3				
AHFM-YO0602-D12-C12-L080-Z03-F	●	12	3	12	80	20	0.3				
AHFM-YO0602-D12-C12-L120-Z02-F	●	12	2	12	120	60	0.3				
AHFM-YO0602-D12-C12-L120-Z03-F	●	12	3	12	120	60	0.3				

DJT Ucuna Uygun. / Compatible with DJT Insert. Kompatibel mit DJT Wendeplatten.

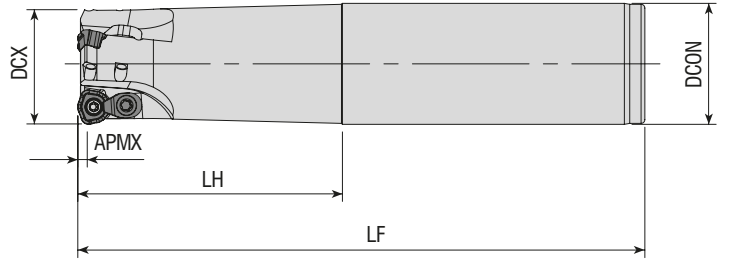

Takım Kodu Ordering Code Bestell-Bezeichnung	Stok Stock Lager	Takım Ölçüleri (mm) Dimension (mm) Abmessung (mm)						Kesici Uç Insert Wendeschneidplatte	Yedek Parçaları / Spare Parts / Ersatzteile			
		DCX	ZEPF	DCON	LF	LH	APMX		Sıkma Vidası Screw Schraube	Baskı Parçası Wedge Clamp Spannpratze	Baskı Vidası Clamp Screw Klemmschraube	Tork Anahtar Torx Key Torx-Schlüssel
AHFM-WD0603-D16-C16-L150-Z02	●	16	2	16	150	70	2	WDMT 0603..	3008-M2.5x6	-	-	80-T08
AHFM-WD0603-D20-C20-L150-Z03	●	20	3	20	150	70	2					
AHFMC-WD0804-D25-C25-L150-Z02	●	25	2	25	150	70	1.5	WDMT 0804..	4010-M3x8	ACK-15	4010-M3x8	80-T10
AHFMC-WD0804-D32-C32-L150-Z03	●	32	3	32	150	70	1.5					
AHFMC-WD1205-D32-C32-L150-Z02	●	32	2	32	150	70	3	WDMT 1205..	1415-M4x11	ACK-05	4015-M4x11	80-T15

R: Sağ / Right / Rechts L: Sol/Left/Links

● Stokta / In Stock / Auf Lager ○ Stokta Yok / Non Stock Item / Kein Lagerartikel, Lieferzeit auf Anfrage

SMTM Ucuna Uygun. / Compatible with SMTM Insert. Kompatibel mit SMTM Wendeplatten.

Sipariş Örneği/Ordering Example/Bestellbeispiel

1 ad./pcs./stück AHFM-YO0602-D10-C09-L120-Z02-F

Kesme Hesabı : S 331 / Cutting Calculation : P 331 / Schnittberechnung : 331



www.akkо.com.tr

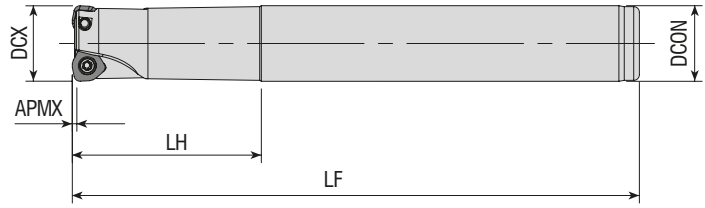

Takım Kodu Ordering Code Bestell-Bezeichnung	Stok Stock Lager	Takım Ölçüleri (mm) Dimension (mm) Abmessung (mm)						Kesici Uç Insert Wendeschneidplatte	Yedek Parçaları / Spare Parts / Ersatzteile			
		DCX	ZEFP	DCON	LF	LH	APMX		Sıkma Vidası Screw Schraube	Baskı Parçası Wedge Clamp Spannpratze	Baskı Vidası Clamp Screw Klemmschraube	Tork Anahtar Torx Key Torx-Schlüssel
AHFM-WD0503D-D20-C20-L150-Z02	●	20	2	20	150	50	1.25	WD.W 0503..	4010-M3x6	-	-	80-T10
AHFM-WD0503D-D21-C20-L150-Z02	●	21	2	20	150	30	1.25					
AHFMC-WD06T3D-D26-C25-L200-Z02	●	26	2	25	200	30	1.5	WD.W 06T3..	3015-M3.5x9	ACK-15	4015-M3.5x11	80-T15
AHFMC-WD06T3D-D33-C32-L200-Z03	●	33	3	32	200	32	1.5					

DJT Ucuna Uygunur. / Compatiple with DJT Insert. Kompatibel mit DJT Wendeplatten.

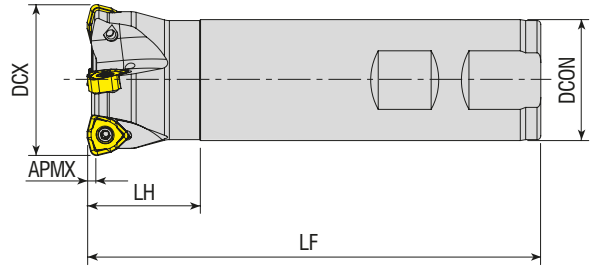

Takım Kodu Ordering Code Bestell-Bezeichnung	Stok Stock Lager	Takım Ölçüleri (mm) Dimension (mm) Abmessung (mm)						Kesici Uç Insert Wendeschneidplatte	Yedek Parçaları / Spare Parts / Ersatzteile	
		DCX	ZEFP	DCON	LF	LH	APMX		Sıkma Vidası Screw Schraube	Tork Anahtar Torx Key Torx-Schlüssel
AHFM-WN0603-D16-C16-L110-Z02-H	●	16	2	16	110	30	1	WNMX 0603..	3008-M2.5x6	80-T08
AHFM-WN0603-D16-C16-L150-Z02-H	●	16	2	16	150	70	1			
AHFM-WN0603-D17-C16-L150-Z02-H	●	17	2	16	150	20	1			
AHFM-WN0603-D20-C20-L150-Z02-H	●	20	2	20	150	70	1			
AHFM-WN0603-D20-C20-L200-Z02-H	●	20	2	20	200	100	1			
AHFM-WN0603-D21-C20-L150-Z02-H	●	21	2	20	150	20	1			
AHFM-WN09T3-D25-W25-L120-Z02-H	●	25	2	25	120	40	1.5	WNMX 09T3..	4010-M3x8	80-T10
AHFML-WN09T3-D25-W25-L120-Z02-H	●	25	2	25	120	40	1.5			
AHFM-WN09T3-D25-C25-L200-Z02	●	25	2	25	200	120	1.5			
AHFM-WN09T3-D32-W32-L120-Z03-H	●	32	3	32	120	30	1.5			
AHFM-WN09T3-D32-W32-L200-Z03-H	○	32	3	32	200	100	1.5			
AHFM-WN09T3-D35-W32-L200-Z04-H	●	35	4	32	200	50	1.5			
AHFM-WN09T3-D40-W32-L120-Z04-H	●	40	4	32	120	30	1.5	WNMX 1305..	4015-M4x11	80-T15
AHFM-WN09T3-D40-C32-L200-Z04	●	40	4	32	200	30	1.5			
AHFM-WN1305-D32-C32-L150-Z02-H	○	32	2	32	150	70	2			
AHFM-WN1305-D32-C32-L200-Z02-H	●	32	2	32	200	120	2	WNMX 1305..	4015-M4x11	80-T15
AHFM-WN1305-D40-C32-L200-Z03-H	●	40	3	32	200	30	2			

R: Sağ / Right / Rechts L: Sol/Left/Links

● Stokta / In Stock / Auf Lager ○ Stokta Yok / Non Stock Item / Kein Lagerartikel, Lieferzeit auf Anfrage
KRLY Ucuna Uygunur. / Compatiple with KRLY Insert. Kompatibel mit KRLY Wendeplatten.

Sipariş Örneği/Ordering Example/Bestellbeispiel

1 ad./pcs./stück AHFM-WD0503D-D20-C20-L150-Z02

Kesme Hesabı : S 331 / Cutting Calculation : P 331 / Schnittberechnung : 331

S-SİSTEM HIZLI İLERLEMELİ PARMAK FREZELER
S-SYSTEM HIGHFEED END MILLS
S-SYSTEM HOCHVORSCHUB- SCHAFTFRÄSER

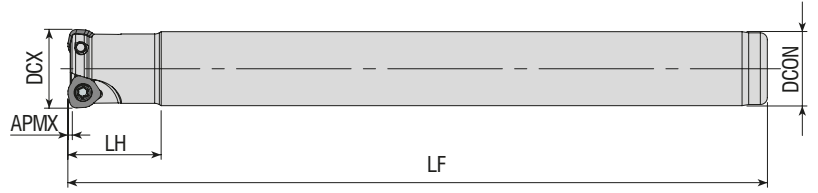

Takım Kodu Ordering Code Bestell-Bezeichnung	Stok Stock Lager	Takım Ölçüleri (mm) Dimension (mm) Abmessung (mm)						Kesici Uç Insert Wendeschneidplatte	Yedek Parçaları / Spare Parts / Ersatzteile	
		DCX	ZEFP	DCON	LF	LH	APMX		Sıkma Vidası Screw Schraube	Tork Anahtar Torx Key Torx-Schlüssel
AHFM-W004T2D-D16-C16-L150-Z02	●	16	2	16	150	20	0.8	WOMW 04T2..	3008-M2.5x6	80-T08
AHFM-W004T2D-D17-C16-L150-Z02	●	17	2	16	150	20	0.8			

DJT Ucuna Uygunur. / Compatible with DJT Insert. Kompatibel mit DJT Wendepplatten.

S-SİSTEM MODÜLER PARMAK FREZELER
S-SYSTEM MODULAR END MILLS (SCREW TYPE TOOLS)
S-SYSTEM EINSCHRAUBFRASER

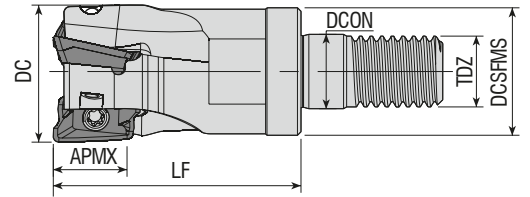
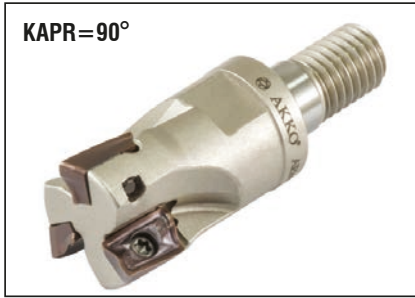

Takım Kodu Ordering Code Bestell-Bezeichnung	Stok Stock Lager	Takım Ölçüleri (mm) Dimension (mm) Abmessung (mm)							Kesici Uç Insert Wendeschneidplatte	Yedek Parçaları / Spare Parts / Ersatzteile	
		DC	Z	DCSFMS	TDZ	LF	DCON	APMX		Sıkma Vidası Screw Schraube	Tork Anahtar Torx Key Torx-Schlüssel
AEM90-A01236-D16-M08-L30-Z02	●	16	2	14.8	M08	30	8.5	12	AO.. 1236..	3008-M2.5x6	80-T08
AEM90-A01236-D20-M10-L35-Z03	●	20	3	18	M10	35	10.5	12			

R: Sağ / Right / Rechts L: Sol/Left/Links

● Stokta / In Stock / Auf Lager ○ Stokta Yok / Non Stock Item / Kein Lagerartikel, Lieferzeit auf Anfrage
MTSBH Ucuna Uygunur. / Compatible with MTSBH Insert. Kompatibel mit MTSBH Wendepplatten.

Sipariş Örneği/Ordering Example/Bestellbeispiel

1 ad./pcs./stück AHFM-W004T2D-D16-C16-L150-Z02

Kesme Hesabı : S 331 / Cutting Calculation : P 331 / Schnittberechnung : 331

Sıkma Tork Değeri : S 330 / Tightening Torque : P 330 / Anzugsmoment : 330



www.akko.com.tr

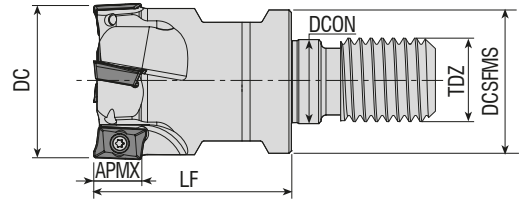

Takım Kodu Ordering Code Bestell-Bezeichnung	Stok Stock Lager	Takım Ölçüleri (mm) Dimension (mm) Abmessung (mm)							Kesici Uç Insert Wendeschneidplatte	Yedek Parçaları / Spare Parts / Ersatzteile	
		DC	ZEFP	DCSFMS	TDZ	LF	DCON	APMX		Sıkma Vidası Screw Schraube	Tork Anahtar Torx Key Torx-Schlüssel
AEM90-AD1505D-D25-M12-L43-Z02-H	●	25	2	21	M12	43	12.5	14.3	ADKT 150508	4015-M4x9	80-T15
AEM90-AD1505D-D32-M16-L43-Z03-H	●	32	3	29	M16	43	17	14.3		4015-M4x11	

DJT Ucuna Uygunur. / Compatible with DJT Insert. Kompatibel mit DJT Wendeplatten.

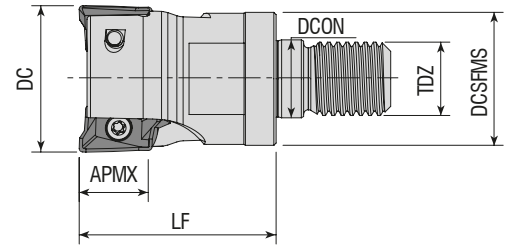

Takım Kodu Ordering Code Bestell-Bezeichnung	Stok Stock Lager	Takım Ölçüleri (mm) Dimension (mm) Abmessung (mm)							Kesici Uç Insert Wendeschneidplatte	Yedek Parçaları / Spare Parts / Ersatzteile	
		DC	ZEFP	DCSFMS	TDZ	LF	DCON	APMX		Sıkma Vidası Screw Schraube	Tork Anahtar Torx Key Torx-Schlüssel
AEM90-AX1235-D16-M08-L30-Z02-H	●	16	2	14.75	M08	30	8.5	10	AX.T 1235..	3008-M3x6	80-T08
AEM90-AX1235-D20-M10-L30-Z03-H	●	20	3	18	M10	30	10.5	10		4015-M4x9	
AEM90-AX1235-D25-M12-L35-Z04-H	●	25	4	21	M12	35	12.5	10	AX.T 1705..	4015-M4x9	80-T15
AEM90-AX1705-D25-M12-L43-Z02-H	●	25	2	21	M12	43	12.5	14			
AEM90-AX1705-D32-M16-L43-Z02-H	●	32	2	29	M16	43	17	14			

R: Sağ / Right / Rechts L: Sol/Left/Links

● Stokta / In Stock / Auf Lager ○ Stokta Yok / Non Stock Item / Kein Lagerartikel, Lieferzeit auf Anfrage
SMTM Ucuna Uygunur. / Compatible with SMTM Insert. Kompatibel mit SMTM Wendeplatten.





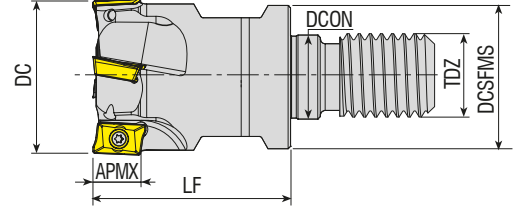

Sipariş Örneği/Ordering Example/Bestellbeispiel

1 ad./pcs./stück AEM90-AD1505D-D25-M12-L43-Z02-H

Kesme Hesabı : S 331 / Cutting Calculation : P 331 / Schnittberechnung : 331

Sıkma Tork Değeri : S 330 / Tightening Torque : P 330 / Anzugsmoment : 330



Takım Kodu Ordering Code Bestell-Bezeichnung	Stok Stock Lager	Takım Ölçüleri (mm) Dimension (mm) Abmessung (mm)							Kesici Uç Insert Wendeschneidplatte	Yedek Parçaları / Spare Parts / Ersatzteile	
		DC	ZEFP	DCSFMS	TDZ	LF	DCON	APMX		Sıkma Vidası Screw Schraube	Tork Anahtar Torx Key Torx-Schlüssel
AEM90-AP10-D16-M08-L30-Z02-H	●	16	2	14.75	M08	30	8.5	10	 AP. 1003.. ISO UCUNA UYGUNDUR. FOR ISO INSERT. <i>Kompatibel mit Wendeschneidplatte ISO</i>	 3008-M2.5x6	 80-T08
AEM90-AP10-D20-M10-L30-Z03-H	●	20	3	18	M10	30	10.5	10			
AEM90-AP10-D25-M12-L35-Z03-H	●	25	3	21	M12	35	12.5	10			
AEM90-AP10-D32-M16-L35-Z04-H	●	32	4	29	M16	35	17	10			
AEM90-AP10-D40-M16-L43-Z05-H	●	40	5	29	M16	43	17	10			
AEM90-AP10-D42-M16-L43-Z05-H	●	42	5	29	M16	43	17	10	 AP. 1003.. DJT UCUNA UYGUNDUR. FOR DJT INSERT. <i>Kompatibel mit Wendeschneidplatte DJT</i>	3008-M2.5x6	80-T08
AEM90-AP10D-D16-M08-L30-Z02-H	●	16	2	14.75	M08	30	8.5	10			
AEM90-AP10D-D20-M10-L30-Z03-H	●	20	3	18	M10	30	10.5	10			
AEM90-AP10D-D25-M12-L35-Z03-H	●	25	3	21	M12	35	12.5	10			
AEM90-AP11-D16-M08-L30-Z02-H	●	16	2	14.75	M08	30	8.5	11			
AEM90-AP11-D20-M10-L30-Z03-H	●	20	3	18	M10	30	10.5	11	 AP. 11T3.. ZCC UCUNA UYGUNDUR. FOR ZCC INSERT. <i>Kompatibel mit Wendeschneidplatte ZCC</i>	4015-M4x9	80-T15
AEM90-AP11-D25-M12-L35-Z03-H	●	25	3	21	M12	35	12.5	11			
AEM90-AP11-D32-M16-L35-Z04-H	●	32	4	29	M16	35	17	11			
AEM90-AP11-D40-M16-L43-Z05-H	●	40	5	29	M16	43	17	11			
AEM90-AP16-D25-M12-L43-Z02-H	●	25	2	21	M12	43	12.5	16			
AEM90-AP16-D32-M16-L43-Z03-H	●	32	3	29	M16	43	17	16	 AP. 1604.. ISO UCUNA UYGUNDUR. FOR ISO INSERT. <i>Kompatibel mit Wendeschneidplatte ISO</i>	4015-M4x9	80-T15
AEM90-AP16-D40-M16-L43-Z04-H	●	40	4	29	M16	43	17	16			
AEM90-AP16-D42-M16-L43-Z04-H	●	42	4	29	M16	43	17	16			
AEM90-AP16D-D25-M12-L43-Z02-H	●	25	2	21	M12	43	12.5	16			
AEM90-AP16D-D32-M16-L43-Z03-H	●	32	3	29	M16	43	17	16			
AEM90-AP16D-D40-M16-L43-Z04-H	●	40	4	29	M16	43	17	16	 AP. 1604.. DJT UCUNA UYGUNDUR. FOR DJT INSERT. <i>Kompatibel mit Wendeschneidplatte DJT</i>	4015-M4x9	80-T15
AEM90-AP16L-D25-M12-L43-Z02-H	●	25	2	21	M12	43	12.5	16			
AEM90-AP16L-D32-M16-L43-Z03-H	●	32	3	29	M16	43	17	16			
AEM90-AP16L-D40-M16-L43-Z04-H	●	40	4	29	M16	43	17	16			
AEM90-AP16L-D32-M16-L43-Z03-H	●	32	3	29	M16	43	17	16			
AEM90-AP16L-D40-M16-L43-Z04-H	●	40	4	29	M16	43	17	16			

R: Sağ / Right / Rechts L: Sol/Left/Links

● Stokta / In Stock / Auf Lager ○ Stokta Yok / Non Stock Item / Kein Lagerartikel, Lieferzeit auf Anfrage

Sipariş Örneği/Ordering Example/Bestellbeispiel

1 ad./pcs./stück AEM90-AP10-D16-M08-L30-Z02-H

Kesme Hesabı : S 331 / Cutting Calculation : P 331 / Schnittberechnung : 331

Sıkma Tork Değeri : S 330 / Tightening Torque : P 330 / Anzugsmoment : 330

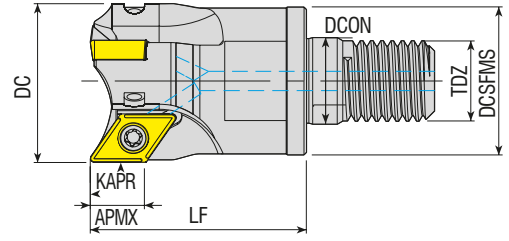

Takım Kodu Ordering Code Bestell-Bezeichnung	Stok Stock Lager	Takım Ölçüleri (mm) Dimension (mm) Abmessung (mm)							Kesici Uç Insert Wendeschneidplatte	Yedek Parçaları / Spare Parts / Ersatzteile	
		DC	ZEFP	DCSFMS	TDZ	LF	DCON	APMX		Sıkma Vidası Screw Schraube	Tork Anahtar Torx Key Torx-Schlüssel
AEM90-DC07-D20-M10-L30-Z02-H	●	20	2	18	M10	30	10.5	7	DC.T 0702.		80-T08
AEM90-DC07-D25-M12-L35-Z03-H	●	25	3	21	M12	35	12.5	7			
AEM90-DC07-D32-M16-L43-Z04-H	●	32	4	29	M16	43	17	7			
AEM90-DC07-D40-M16-L43-Z05-H	●	40	5	29	M16	43	17	7			
AEM90-DC11-D32-M16-L43-Z03-H-F	●	32	3	29	M16	43	17	11	DC.T 11T3..		80-T15
AEM90-DC11-D40-M16-L43-Z03-H-F	●	40	3	29	M16	43	17	11			

F: Çap toleransı +/- 0.02 mm içerisinde anlamına gelmektedir. / F: Diameter tolerance is between +/- 0.02 mm. / F: Durchmesser-toleranz zwischen +/- 0,02 mm
ISO Ucuna Uygunudur. / Compatible with ISO Insert. Kompatibel mit ISO Wendeplatten.

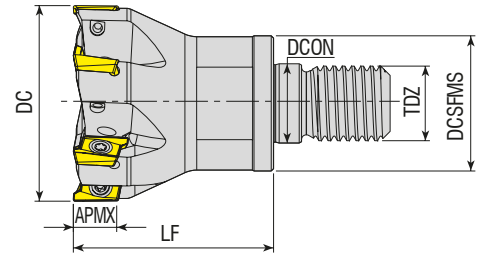

Takım Kodu Ordering Code Bestell-Bezeichnung	Stok Stock Lager	Takım Ölçüleri (mm) Dimension (mm) Abmessung (mm)							Kesici Uç Insert Wendeschneidplatte	Yedek Parçaları / Spare Parts / Ersatzteile	
		DC	ZEFP	DCSFMS	TDZ	LF	DCON	APMX		Sıkma Vidası Screw Schraube	Tork Anahtar Torx Key Torx-Schlüssel
AEM90-RT10-D16-M08-L20-Z02-H	●	16	2	14.75	M08	20	8.5	10	RT 1003..		80-T08
AEM90-RT10-D20-M10-L25-Z03-H	●	20	3	18	M10	25	10.5	10			
AEM90-RT10-D25-M12-L30-Z04-H	●	25	4	21	M12	30	12.5	10			
AEM90-RT10-D32-M16-L43-Z05-H	●	32	5	29	M16	43	17	10			
AEM90-RT10-D42-M16-L43-Z06-H	●	42	6	29	M16	43	17	10			

R: Sağ / Right / Rechts L: Sol/Left/Links
● Stokta / In Stock / Auf Lager ○ Stokta Yok / Non Stock Item / Kein Lagerartikel, Lieferzeit auf Anfrage
SFTY Ucuna Uygunudur. / Compatible with SFTY Insert. Kompatibel mit SFTY Wendeplatten.

Sipariş Örneği/Ordering Example/Bestellbeispiel
1 ad./pcs./stück AEM90-DC07-D20-M10-L30-Z02-H
Kesme Hesabı : S 331 / Cutting Calculation : P 331 / Schnittberechnung : 331
Sıkma Tork Değeri : S 330 / Tightening Torque : P 330 / Anzugsmoment : 330

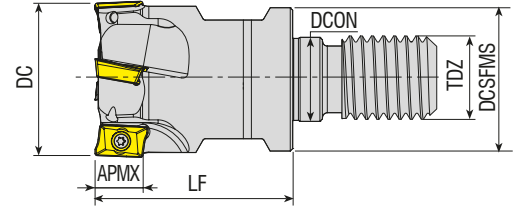

Takım Kodu Ordering Code Bestell-Bezeichnung	Stok Stock Lager	Takım Ölçüleri (mm) Dimension (mm) Abmessung (mm)							Kesici Uç Insert Wendeschneidplatte	Yedek Parçaları / Spare Parts / Ersatzteile	
		DC	ZEFP	DCSFMS	TDZ	LF	DCON	APMX		Sıkma Vidası Screw Schraube	Tork Anahtar Torx Key Torx-Schlüssel
AEM90-R390.11-D16-M08-L30-Z02-H	●	16	2	14.75	M08	30	8.5	10	R390-11T3..		80-T08
AEM90-R390.11-D20-M10-L30-Z03-H	●	20	3	18	M10	30	10.5	10			
AEM90-R390.11-D25-M12-L35-Z03-H	●	25	3	21	M12	35	12.5	10			
AEM90-R390.11-D32-M16-L43-Z04-H	●	32	4	29	M16	43	17	10			

SNDVK Ucuna Uygun. / Compatible with SNDVK Insert. Kompatibel mit SNDVK Wendeplatten.

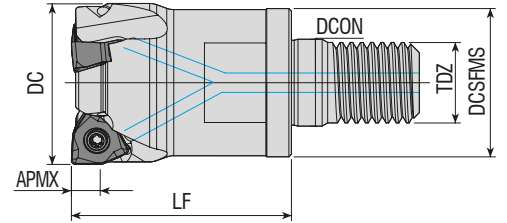

Takım Kodu Ordering Code Bestell-Bezeichnung	Stok Stock Lager	Takım Ölçüleri (mm) Dimension (mm) Abmessung (mm)							Kesici Uç Insert Wendeschneidplatte	Yedek Parçaları / Spare Parts / Ersatzteile	
		DC	ZEFP	DCSFMS	TDZ	LF	DCON	APMX		Sıkma Vidası Screw Schraube	Tork Anahtar Torx Key Torx-Schlüssel
AEM90-WN0604Z-D25-M12-L35-Z02-H	●	25	2	21	M12	35	12.5	5.7	WNHU 0604..		80-T08
AEM90-WN0604Z-D32-M16-L43-Z03-H	●	32	3	29	M16	43	17	5.7			
AEM90-WN0604Z-D40-M16-L43-Z04-H	●	40	4	29	M16	43	17	5.7			

R: Sağ / Right / Rechts L: Sol/Left/Links
 ● Stokta / In Stock / Auf Lager ○ Stokta Yok / Non Stock Item / Kein Lagerartikel, Lieferzeit auf Anfrage
 ZCC Ucuna Uygun. / Compatible with ZCC Insert. Kompatibel mit ZCC Wendeplatten.

Sipariş Örneği/Ordering Example/Bestellbeispiel
 1 ad./pcs./stück AEM90-R390.11-D16-M08-L30-Z02-H
 Kesme Hesabı : S 331 / Cutting Calculation : P 331 / Schnittberechnung : 331
 Sıkma Tork Değeri : S 330 / Tightening Torque : P 330 / Anzugsmoment : 330



KAPR=90°

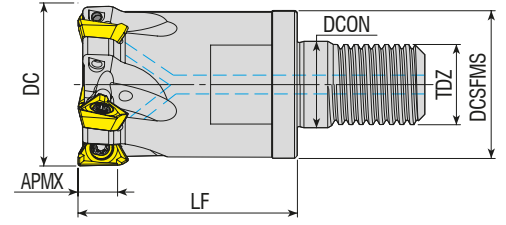

Takım Kodu Ordering Code Bestell-Bezeichnung	Stok Stock Lager	Takım Ölçüleri (mm) Dimension (mm) Abmessung (mm)							Kesici Uç Insert Wendeschneidplatte	Yedek Parçaları / Spare Parts / Ersatzteile		
		DC	ZEP	DCSFMS	TDZ	LF	DCON	APMX		Sıkma Vidası Screw Schraube	Baskı Parçası Wedge Clamp Spannpratze	Tork Anahtar Torx Key Torx-Schlüssel
AEM90-3P1004-D20-M10-L35-Z02	●	20	2	18	10	35	10.5	7	3PT 1004	1108-M2.5x6	80-T08	
AEM90-3P1004-D32-M16-L43-Z05-H	●	32	5	29	16	43	17	7				

TGTC Ucuna Uygun. / Compatible with TGTC Insert. Kompatibel mit TGTC Wendeplatten.

KAPR=95°

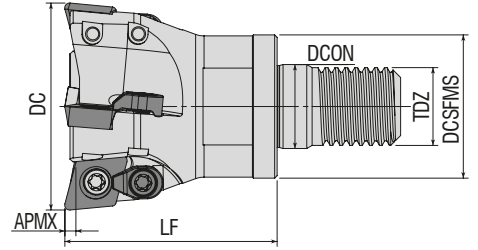
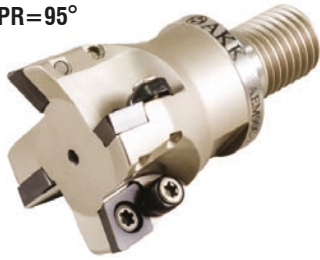

Takım Kodu Ordering Code Bestell-Bezeichnung	Stok Stock Lager	Takım Ölçüleri (mm) Dimension (mm) Abmessung (mm)							Kesici Uç Insert Wendeschneidplatte	Yedek Parçaları / Spare Parts / Ersatzteile			
		DC	ZEP	DCSFMS	TDZ	LF	DCON	APMX		Sıkma Vidası Screw Schraube	Baskı Parçası Wedge Clamp Spannpratze	Baskı Vidası Clamp Screw Klemmschraube	Tork Anahtar Torx Key Torx-Schlüssel
AEM95-XD0206-D16-M08-L23-Z02-H	●	16	2	14.75	M08	23	8.5	1	XDHW 0206..	3008-M2.5x5	-	-	80-T08
AEM95-XD0206-D16-M08-L23-Z02-H-F	●	16	2	14.75	M08	23	8.5	1					
AEM95-XD0206-D20-M10-L30-Z03-H	●	20	3	18	M10	30	10.5	1					
AEM95-XD0206-D20-M10-L30-Z03-H-F	●	20	3	18	M10	30	10.5	1					
AEM95-XD0206-D25-M12-L35-Z03-H	●	25	3	21	M12	35	12.5	1					
AEM95-XD0206-D25-M12-L35-Z03-H-F	●	25	3	21	M12	35	12.5	1					
AEM95C-XD0310-D35-M16-L43-Z03-H	●	35	3	29	M16	43	17	1.5	XDHW 0310..	3015-M3.5x9	ACK-15	4015-M3.5x11	80-T15
AEM95C-XD0310-D35-M16-L43-Z03-H-F	●	35	3	29	M16	43	17	1.5					
AEM95C-XD0310-D42-M16-L43-Z04-H	●	42	4	29	M16	43	17	1.5					
AEM95C-XD0310-D42-M16-L43-Z04-H-F	●	42	4	29	M16	43	17	1.5					

F: Çap toleransı +/- 0.02 mm içerisinde anlamına gelmektedir. / F: Diameter tolerance is between +/- 0.02 mm. / F: Durchmesser toleranz zwischen +/- 0,02 mm

R: Sağ / Right / Rechts L: Sol/Left/Links

● Stokta / In Stock / Auf Lager ○ Stokta Yok / Non Stock Item / Kein Lagerartikel, Lieferzeit auf Anfrage

DJT Ucuna Uygun. / Compatible with DJT Insert. Kompatibel mit DJT Wendeplatten.

Sipariş Örneği/Ordering Example/Bestellbeispiel

1 ad./pcs./stück AEM90-3P1004-D20-M10-L35-Z02

Kesme Hesabı : S 331 / Cutting Calculation : P 331 / Schnittberechnung : 331

Sıkma Tork Değeri : S 330 / Tightening Torque : P 330 / Anzugsmoment : 330

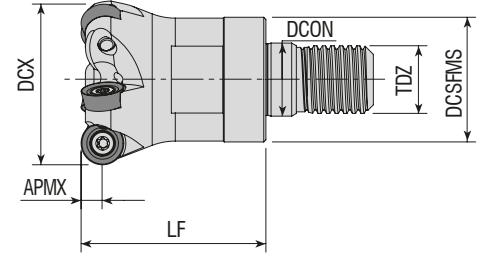

Takım Kodu Ordering Code Bestell-Bezeichnung	Stok Stock Lager	Takım Ölçüleri (mm) Dimension (mm) Abmessung (mm)							Kesici Uç Insert Wendeschneidplatte	Yedek Parçaları / Spare Parts / Ersatzteile		
		DCX	ZEFP	DCSFMS	TDZ	LF	DCON	APMX		Sıkma Vidası Screw Schraube	Tork Anahtar Torx Key Torx-Schlüssel	
AEMR-RC10T3-D25-M12-L35-Z03-H	●	25	3	21	M12	35	12.5	5	RC.. 10T3..	4015-M4x9	80-T15	
AEMR-RC10T3-D32-M16-L43-Z04-H	●	32	4	29	M16	43	17	5				
AEMR-RC10T3-D40-M16-L43-Z05-H	●	40	5	29	M16	43	17	5				

ZCC Ucuna Uygundur. / Compatible with ZCC Insert. Kompatibel mit ZCC Wendeplatten.

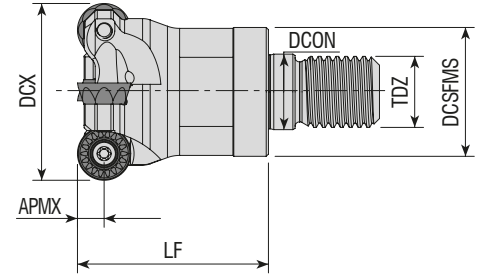

Takım Kodu Ordering Code Bestell-Bezeichnung	Stok Stock Lager	Takım Ölçüleri (mm) Dimension (mm) Abmessung (mm)							Kesici Uç Insert Wendeschneidplatte	Yedek Parçaları / Spare Parts / Ersatzteile		
		DCX	ZEFP	DCSFMS	TDZ	LF	DCON	APMX		Sıkma Vidası Screw Schraube	Tork Anahtar Torx Key Torx-Schlüssel	
AEMR-RP08T2M-D20-M10-L30-Z02-H	●	20	2	18	M10	30	10.5	4	RPMT 08T2..	3008-M2.5x6	80-T08	
AEMR-RP10T3M-D25-M12-L35-Z02-H	●	25	2	21	M12	35	12.5	5	RPMT 10T3..	4015-M3.5x9	80-T15	
AEMR-RP10T3M-D32-M16-L43-Z03-H	●	32	3	29	M16	43	17	5	RPMT 1204..	4015-M4x9		
AEMR-RP1204M-D32-M16-L43-Z03-H	●	32	3	29	M16	43	17	6				
AEMR-RP1204M-D40-M16-L43-Z04-H	●	40	4	29	M16	43	17	6				

R: Sağ / Right / Rechts L: Sol/Left/Links

● Stokta / In Stock / Auf Lager ○ Stokta Yok / Non Stock Item / Kein Lagerartikel, Lieferzeit auf Anfrage
MTSBSH Ucuna Uygundur. / Compatible with MTSBSH Insert. Kompatibel mit MTSBSH Wendeplatten.

Sipariş Örneği/Ordering Example/Bestellbeispiel

1 ad./pcs./stück AEMR-RC10T3-D25-M12-L35-Z03-H

Kesme Hesabı : S 331 / Cutting Calculation : P 331 / Schnittberechnung : 331

Sıkma Tork Değeri : S 330 / Tightening Torque : P 330 / Anzugsmoment : 330

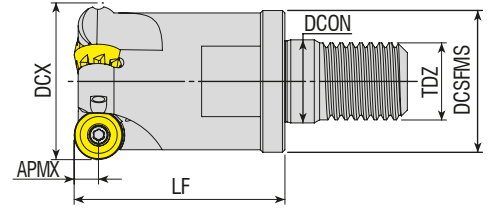

Takım Kodu Ordering Code Bestell-Bezeichnung	Stok Stock Lager	Takım Ölçüleri (mm) Dimension (mm) Abmessung (mm)							Kesici Uç Insert Wendeschneidplatte	Yedek Parçaları / Spare Parts / Ersatzteile		
		DCX	ZEPF	DCSFMS	TDZ	LF	DCON	APMX		Sıkma Vidası Screw Schraube	Tork Anahtar Torx Key Torx-Schlüssel	
AEMR-RP10T3-D25-M12-L35-Z02-H	●	25	2	21	12	35	12.5	5	RPNX 10T3..	4010-M3x8	80-T10	
AEMR-RP10T3-D32-M16-L43-Z03-H	●	32	3	29	16	43	17	5				
AEMR-RP1204-D32-M16-L43-Z03-H	●	32	3	29	16	43	17	6	RPNX 1204..	4015-M4x9	80-T15	

CRTZT Ucuna Uygun. / Compatible with CRTZT Insert. Kompatibel mit CRTZT Wendeplatten.

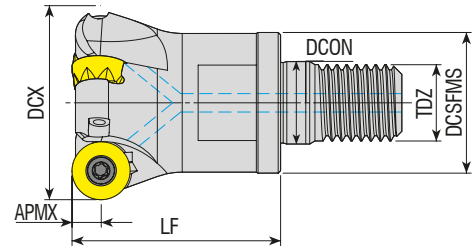

Takım Kodu Ordering Code Bestell-Bezeichnung	Stok Stock Lager	Takım Ölçüleri (mm) Dimension (mm) Abmessung (mm)							Kesici Uç Insert Wendeschneidplatte	Yedek Parçaları / Spare Parts / Ersatzteile		
		DCX	ZEPF	DCSFMS	TDZ	LF	DCON	APMX		Sıkma Vidası Screw Schraube	Tork Anahtar Torx Key Torx-Schlüssel	
AEMR-RY10-D32-M16-L43-Z04-H	●	32	4	29	M16	43	17	5	RYMX 1004..	4015-M3.5x9	80-T15	
AEMR-RY10-D40-M16-L43-Z05-H	●	40	5	29	M16	43	17	5				
AEMR-RY12-D32-M16-L43-Z03-H	●	32	3	29	M16	43	17	6	RYMX 1205..	4015-M4x9	80-T15	
AEMR-RY12-D40-M16-L43-Z03-H	●	40	3	29	M16	43	17	6				

R: Sağ / Right / Rechts L: Sol/Left/Links

● Stokta / In Stock / Auf Lager ○ Stokta Yok / Non Stock Item / Kein Lagerartikel, Lieferzeit auf Anfrage

TGTC Ucuna Uygun. / Compatible with TGTC Insert. Kompatibel mit TGTC Wendeplatten.

Sipariş Örneği/Ordering Example/Bestellbeispiel

1 ad./pcs./stück AEMR-RP10T3-D25-M12-L35-Z02-H

Kesme Hesabı : S 331 / Cutting Calculation : P 331 / Schnittberechnung : 331

Sıkma Tork Değeri : S 330 / Tightening Torque : P 330 / Anzugsmoment : 330

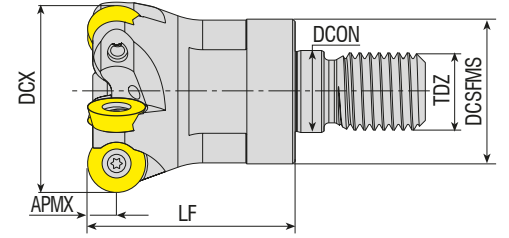

Takım Kodu Ordering Code Bestell-Bezeichnung	Stok Stock Lager	Takım Ölçüleri (mm) Dimension (mm) Abmessung (mm)							Kesici Uç Insert Wendeschneidplatte	Yedek Parçaları / Spare Parts / Ersatzteile	
		DCX	ZEPF	DCSFMS	TDZ	LF	DCON	APMX		Sıkma Vidası Screw Schraube	Tork Anahtar Torx Key Torx-Schlüssel
AEMR-RD0702-D15-M08-L23-Z02-H	●	15	2	13	M08	23	8.5	3.5	RD.. 0702	3008-M2.5x6	80-T08
AEMR-RD0702-D16-M08-L23-Z02-H	●	16	2	13	M08	23	8.5	3.5			
AEMR-RD0702-D20-M10-L30-Z04-H	●	20	4	18	M10	30	10.5	3.5			
AEMR-RD0702-D25-M12-L35-Z05-H	●	25	5	21	M12	35	12.5	3.5			
AEMR-RD0702-D30-M16-L42-Z05-H	●	30	5	29	M16	42	17	3.5			
AEMR-RD0702-D32-M16-L43-Z05-H	●	32	5	29	M16	43	17	3.5			
AEMR-RD0702-D35-M16-L42-Z06-H	●	35	6	29	M16	42	17	3.5			
AEMR-RD0702-D42-M16-L43-Z05-H	●	42	5	29	M16	43	17	3.5			
AEMR-RD0702-D42-M16-L43-Z07-H	●	42	7	29	M16	43	17	3.5			
AEMR-RD08T2-D16-M08-L23-Z02-H	●	16	2	13	M08	23	8.5	4	RD.. 08T2	3008-M2.5x6	80-T08
AEMR-RD08T2-D16-M10-L23-Z02-H	●	16	2	13	M10	23	8.5	4			
AEMR-RD08T2-D20-M10-L30-Z03-H	●	20	3	18	M10	30	10.5	4			
AEMR-RD08T2-D25-M12-L35-Z04-H	●	25	4	21	M12	35	12.5	4	RD.. 0802	3008-M3x6	80-T15
AEMR-RD0802-D16-M08-L23-Z02-H	●	16	2	13	M08	23	8.5	4	RD.. 0803	3008-M3x8	
AEMR-RD0803-D16-M08-L23-Z02-H	●	16	2	13	M08	23	8.5	4			
AEMR-RD0803-D20-M10-L30-Z03-H	●	20	3	18	M10	30	10.5	4			
AEMR-RD0803-D25-M12-L35-Z04-H	●	25	4	21	M12	35	12.5	4			
AEMR-RD1003-D20-M10-L30-Z02-H	●	20	2	18	M10	30	10.5	5	RD.. 1003	4015-M3.5x9	80-T15
AEMR-RD1003-D25-M12-L35-Z02-H	●	25	2	21	M12	35	12.5	5			
AEMR-RD1003-D25-M12-L35-Z03-H	●	25	3	21	M12	35	12.5	5			
AEMR-RD1003-D30-M16-L43-Z04-H	●	30	4	29	M16	43	17	5			
AEMR-RD1003-D32-M16-L43-Z04-H	●	32	4	29	M16	43	17	5			
AEMR-RD1003-D35-M16-L43-Z04-H	●	35	4	29	M16	43	17	5			
AEMR-RD1003-D40-M16-L43-Z05-H	●	40	5	29	M16	43	17	5			
AEMR-RD1003-D42-M16-L43-Z05-H	●	42	5	29	M16	43	17	5			
AEMR-RD1004-D25-M12-L35-Z03-H	●	25	3	21	M12	35	12.5	5	RD.. 1004	4515-M4x8	
AEMR-RD1004-D32-M16-L43-Z04-H	●	32	4	29	M16	43	17	5			
AEMR-RD12T3-D24-M12-L35-Z02-H	●	24	2	21	M12	35	12.5	6	RD.. 12T3	4015-M3.5x9	80-T15
AEMR-RD12T3-D25-M12-L35-Z02-H	●	25	2	21	M12	35	12.5	6			
AEMR-RD12T3-D32-M16-L43-Z03-H	●	32	3	29	M16	43	17	6			
AEMR-RD12T3-D35-M16-L43-Z03-H	●	35	3	29	M16	43	17	6			
AEMR-RD12T3-D35-M16-L43-Z04-H	●	35	4	29	M16	43	17	6			
AEMR-RD12T3-D40-M16-L43-Z04-H	●	40	4	29	M16	43	17	6			
AEMR-RD12T3-D42-M16-L43-Z05-H	●	42	5	29	M16	43	17	6			
AEMR-RD1204-D32-M16-L43-Z03-H	●	32	3	29	M16	43	17	6			
AEMR-RD1204-D42-M16-L43-Z04-H	●	42	4	29	M16	43	17	6			
AEMR-RD1604-D32-M16-L43-Z02-H	●	32	2	29	M16	43	17	8	RD.. 1604	4015-M4.5x11	80-T15
AEMR-RD1604-D40-M16-L43-Z02-H	●	40	2	29	M16	43	17	8			
AEMR-RD1604-D42-M16-L43-Z03-H	●	42	3	29	M16	43	17	8			

R: Sağ / Right / Rechts L: Sol/Left/Links

● Stokta / In Stock / Auf Lager ○ Stokta Yok / Non Stock Item / Kein Lagerartikel, Lieferzeit auf Anfrage
ISO Uçuna Uygunudur. / Compatible with ISO Insert. Kompatibel mit ISO Wendepalten.

Sipariş Örneği/Ordering Example/Bestellbeispiel



1 ad./pcs./stück AEMR-RD0702-D15-M08-L23-Z02-H

Kesme Hesabı : S 331 / Cutting Calculation : P 331 / Schnittberechnung : 331

Sıkma Tork Değeri : S 330 / Tightening Torque : P 330 / Anzugsmoment : 330

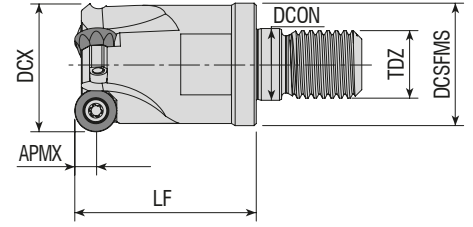



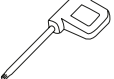



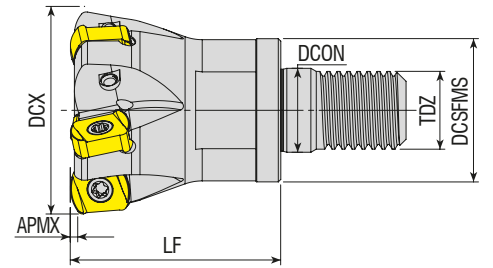

Takım Kodu Ordering Code Bestell-Bezeichnung	Stok Stock Lager	Takım Ölçüleri (mm) Dimension (mm) Abmessung (mm)							Kesici Uç Insert Wendeschneidplatte	Yedek Parçaları / Spare Parts / Ersatzteile		
		DCX	ZEFP	DCSFMS	TDZ	LF	DCON	APMX		Sıkma Vidası Screw Schraube	Tork Anahtar Torx Key Torx-Schlüssel	
AEMR-QP10T3-D25-M12-L35-Z02-H	●	25	2	21	M12	35	12.5	5				
AEMR-QP10T3-D32-M16-L43-Z03-H	●	32	3	29	M16	43	17	5				QP. 10T3..

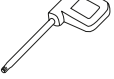
SMTM Ucuna Uygun. / Compatiple with SMTM Insert. Kompatibel mit SMTM Wendeplatten.



Takım Kodu Ordering Code Bestell-Bezeichnung	Stok Stock Lager	Takım Ölçüleri (mm) Dimension (mm) Abmessung (mm)							Kesici Uç Insert Wendeschneidplatte	Yedek Parçaları / Spare Parts / Ersatzteile		
		DCX	ZEFP	DCSFMS	TDZ	LF	DCON	APMX		Sıkma Vidası Screw Schraube	Tork Anahtar Torx Key Torx-Schlüssel	
AHFM-BL0603-D20-M10-L30-Z03-H	●	20	3	18	M10	30	10.5	1				
AHFM-BL0603-D32-M16-L40-Z05-H	●	32	5	29	M16	40	17	1				BLMP 0603..
AHFM-BL0904-D32-M16-L40-Z04-H	●	32	4	29	M16	40	17	1.5				
AHFM-BL0904-D42-M16-L43-Z05-H	●	42	5	29	M16	43	17	1.5				BLMP 0904..

R: Sağ / Right / Rechts L: Sol/Left/Links

● Stokta / In Stock / Auf Lager ○ Stokta Yok / Non Stock Item / Kein Lagerartikel, Lieferzeit auf Anfrage

TGTC Ucuna Uygun. / Compatiple with TGTC Insert. Kompatibel mit TGTC Wendeplatten.

Sipariş Örneği/Ordering Example/Bestellbeispiel

1 ad./pcs./stück AEMR-QP10T3-D25-M12-L35-Z02-H

Kesme Hesabı : S 331 / Cutting Calculation : P 331 / Schnittberechnung : 331

Sıkma Tork Değeri : S 330 / Tightening Torque : P 330 / Anzugsmoment : 330

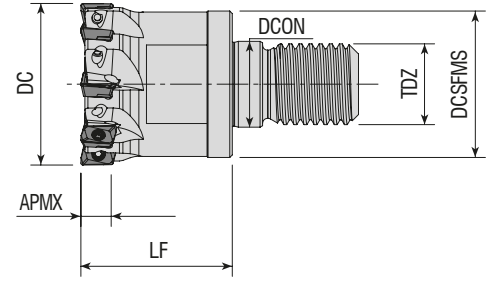

Takım Kodu Ordering Code Bestell-Bezeichnung	Stok Stock Lager	Takım Ölçüleri (mm) Dimension (mm) Abmessung (mm)							Kesici Uç Insert Wendeschneidplatte	Yedek Parçaları / Spare Parts / Ersatzteile	
		DC	ZEFP	DCSFMS	TDZ	LF	DCON	APMX		Sıkma Vidası Screw Schraube	Tork Anahtar Torx Key Torx-Schlüssel
AHFM-ED0702-D12-M06-L20-Z03	●	12	3	10	M06	20	6.5	6	EDMT 0702 JDMT 070204	3006-M1.8x4	80-T06
AHFM-ED0702-D16-M08-L25-Z04-H	●	16	4	14.75	M08	25	8.5	6			
AHFM-ED0702-D20-M10-L30-Z05-H	●	20	5	18	M10	30	10.5	6			
AHFM-ED0702-D25-M12-L30-Z06-H	●	25	6	21	M12	30	12.5	6			
AHFM-ED0702-D32-M16-L30-Z08-H	●	32	8	29	M16	30	17	6			

HTCH Ucuna Uygunur. / Compatible with HTCH Insert. Kompatibel mit HTCH Wendeplatten.

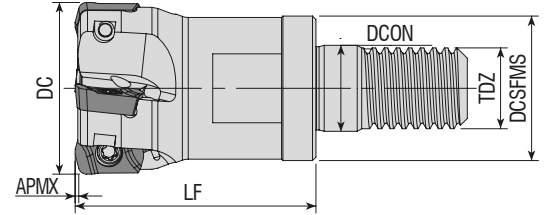

Takım Kodu Ordering Code Bestell-Bezeichnung	Stok Stock Lager	Takım Ölçüleri (mm) Dimension (mm) Abmessung (mm)							Kesici Uç Insert Wendeschneidplatte	Yedek Parçaları / Spare Parts / Ersatzteile	
		DC	ZEFP	DCSFMS	TDZ	LF	DCON	APMX		Sıkma Vidası Screw Schraube	Tork Anahtar Torx Key Torx-Schlüssel
AHFM-EP1003-D16-M08-L23-Z02-H	●	16	2	14.75	M08	23	8.5	1	EP. 1003.. ZPMT 1003.. YPHW 1003..	3008-M2.5x5	80-T08
AHFM-EP1003-D20-M10-L30-Z04-H	●	20	4	18	M10	30	10.5	1			
AHFM-EP1003-D25-M12-L35-Z04-H	●	25	4	21	M12	35	12.5	1			
AHFM-EP1003-D32-M16-L43-Z05-H	●	32	5	29	M16	43	17	1			
AHFM-EP1003-D35-M16-L43-Z05-H	●	35	5	29	M16	43	17	1			
AHFM-EP1003-D42-M16-L43-Z06-H	●	42	6	29	M16	43	17	1			

R: Sağ / Right / Rechts L: Sol/Left/Links

● Stokta / In Stock / Auf Lager ○ Stokta Yok / Non Stock Item / Kein Lagerartikel, Lieferzeit auf Anfrage

DJT Ucuna Uygunur. / Compatible with DJT Insert. Kompatibel mit DJT Wendeplatten.

Sipariş Örneği/Ordering Example/Bestellbeispiel

1 ad./pcs./stück AHFM-ED0702-D12-M06-L20-Z03

Kesme Hesabı : S 331 / Cutting Calculation : P 331 / Schnittberechnung : 331

Sıkma Tork Değeri : S 330 / Tightening Torque : P 330 / Anzugsmoment : 330

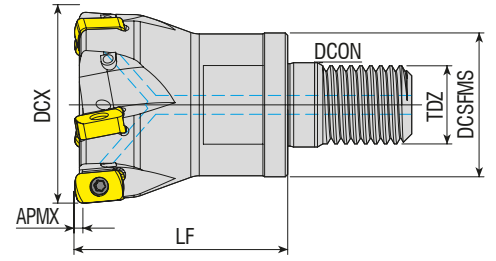

Takım Kodu Ordering Code Bestell-Bezeichnung	Stok Stock Lager	Takım Ölçüleri (mm) Dimension (mm) Abmessung (mm)						Kesici Uç Insert Wendeschneidplatte	Yedek Parçaları / Spare Parts / Ersatzteile				
		DCX	ZEP	DCSFMS	TDZ	LF	DCON		APMX	Sıkma Vidası Screw Schraube	Baskı Parçası Wedge Clamp Spannpratze	Baskı Vidası Clamp Screw Klemmschraube	Tork Anahtar Torx Key Torx-Schlüssel
AHFM-EN1004-D16-M08-L23-Z02-H	●	16	2	14.75	M08	23	8.5	1	ENMU 1004..	3008-M2.5x5			80-T08
AHFM-EN1004-D20-M10-L30-Z03-H	●	20	3	18	M10	30	10.5	1					
AHFM-EN1004-D25-M12-L35-Z03-H	●	25	3	21	M12	35	12.5	1					
AHFM-EN1004-D25-M12-L35-Z04-H	●	25	4	21	M12	35	12.5	1					
AHFM-EN1004-D32-M16-L43-Z05-H	●	32	5	29	M16	43	17	1					
AHFM-EN1004-D35-M16-L43-Z05-H	●	35	5	29	M16	43	17	1					
AHFM-EN1004-D40-M16-L43-Z05-H	●	40	5	29	M16	43	17	1					
AHFM-EN1004-D42-M16-L43-Z05-H	●	42	5	29	M16	43	17	1					

DJT Ucuna Uygundur. / Compatiple with DJT Insert. Kompatibel mit DJT Wendepplatten.

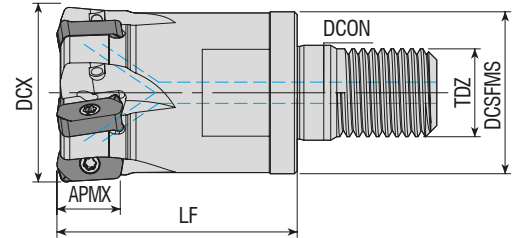

Takım Kodu Ordering Code Bestell-Bezeichnung	Stok Stock Lager	Takım Ölçüleri (mm) Dimension (mm) Abmessung (mm)						Kesici Uç Insert Wendeschneidplatte	Yedek Parçaları / Spare Parts / Ersatzteile				
		DCX	ZEP	DCSFMS	TDZ	LF	DCON		APMX	Sıkma Vidası Screw Schraube	Baskı Parçası Wedge Clamp Spannpratze	Baskı Vidası Clamp Screw Klemmschraube	Tork Anahtar Torx Key Torx-Schlüssel
AHFM-LN120-D25-M12-L35-Z04-H	●	25	4	21	M12	35	12.5	12	LNMX 1235..	3008-M2.5x6			80-T08
AHFM-LN120-D32-M16-L43-Z05-H	●	32	5	29	M16	43	17	12					
AHFM-LN120-D42-M16-L43-Z06-H	●	42	6	29	M16	43	17	12					

R: Sağ / Right / Rechts L: Sol/Left/Links

● Stokta / In Stock / Auf Lager ○ Stokta Yok / Non Stock Item / Kein Lagerartikel, Lieferzeit auf Anfrage

B.OKE Ucuna Uygundur. / Compatiple with B.OKE Insert. Kompatibel mit B.OKE Wendepplatten.

Sipariş Örneği/Ordering Example/Bestellbeispiel

1 ad./pcs./stück AHFM-EN1004-D16-M08-L23-Z02-H

Kesme Hesabı : S 331 / Cutting Calculation : P 331 / Schnittberechnung : 331

Sıkma Tork Değeri : S 330 / Tightening Torque : P 330 / Anzugsmoment : 330

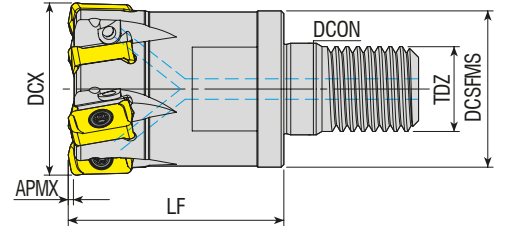

Takım Kodu Ordering Code Bestell-Bezeichnung	Stok Stock Lager	Takım Ölçüleri (mm) Dimension (mm) Abmessung (mm)							Kesici Uç Insert Wendeschneidplatte	Yedek Parçaları / Spare Parts / Ersatzteile			
		DCX	ZEFP	DCSFMS	TDZ	LF	DCON	APMX		Sıkma Vidası Screw Schraube	Baskı Parçası Wedge Clamp Spannpratze	Baskı Vidası Clamp Screw Klemmschraube	Tork Anahtar Torx Key Torx-Schlüssel
AHFM-L003-D20-M10-L30-Z04-H-F	●	20	4	18	M10	30	10.5	1	LOGU 0303..	1108-M3x6.8	-	-	80-T08
AHFM-L003-D25-M12-L35-Z04-H-F	●	25	4	21	M12	35	12.5	1					
AHFM-L003-D25-M12-L35-Z04-H	●	25	4	21	M12	35	12.5	1					
AHFM-L003-D32-M16-L40-Z05-H-F	●	32	5	29	M16	40	17	1					
AHFM-L003-D32-M16-L40-Z05-H	●	32	5	29	M16	40	17	1					
AHFM-L003-D32-M16-L40-Z06-H-F	●	32	6	29	M16	40	17	1					
AHFM-L003-D32-M16-L40-Z06-H	●	32	6	29	M16	40	17	1					
AHFM-L003-D35-M16-L40-Z06-H	●	35	6	29	M16	40	17	1					
AHFM-L003-D42-M16-L40-Z05-H	●	42	5	29	M16	40	17	1					
AHFM-L003-D42-M16-L40-Z06-H	●	42	6	29	M16	40	17	1					

F: Çap toleransı +/- 0.02 mm içerisinde anlamına gelmektedir. / F: Diameter tolerance is between +/- 0.02 mm. / F: Durchmesser-toleranz zwischen +/- 0,02 mm
KYCR Ucuna Uygunur. / Compatible with KYCR Insert. Kompatibel mit KYCR Wendepfatten.

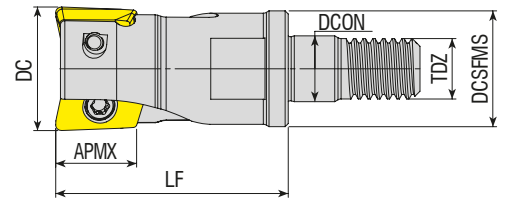
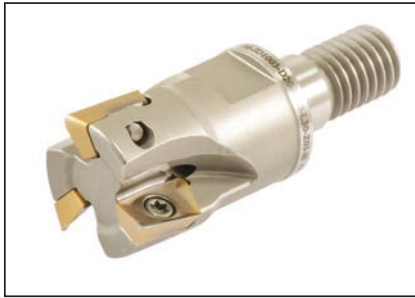

Takım Kodu Ordering Code Bestell-Bezeichnung	Stok Stock Lager	Takım Ölçüleri (mm) Dimension (mm) Abmessung (mm)							Kesici Uç Insert Wendeschneidplatte	Yedek Parçaları / Spare Parts / Ersatzteile	
		DC	ZEFP	DCSFMS	TDZ	LF	DCON	APMX		Sıkma Vidası Screw Schraube	Tork Anahtar Torx Key Torx-Schlüssel
AHFM-JD1003-D16-M08-L30-Z02-H	●	16	2	14.75	M8	30	8.5	9	JDMT 1003..	3008-M2.5x6	80-T08
AHFM-JD1003-D20-M10-L30-Z03-H	●	20	3	18	M10	30	10.5	9			

R: Sağ / Right / Rechts L: Sol/Left/Links
● Stokta / In Stock / Auf Lager ○ Stokta Yok / Non Stock Item / Kein Lagerartikel, Lieferzeit auf Anfrage
HTCH Ucuna Uygunur. / Compatible with HTCH Insert. Kompatibel mit HTCH Wendepfatten.

Sipariş Örneği/Ordering Example/Bestellbeispiel
1 ad./pcs./stück AHFM-L003-D20-M10-L30-Z04-H-F
Kesme Hesabı : S 331 / Cutting Calculation : P 331 / Schnittberechnung : 331
Sıkma Tork Değeri : S 330 / Tightening Torque : P 330 / Anzugsmoment : 330

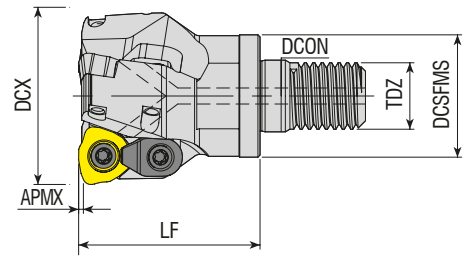
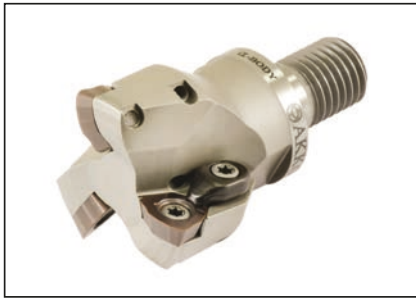

Takım Kodu Ordering Code Bestell-Bezeichnung	Stok Stock Lager	Takım Ölçüleri (mm) Dimension (mm) Abmessung (mm)						Kesici Uç Insert Wendeschneidplatte	Yedek Parçaları / Spare Parts / Ersatzteile				
		DCX	ZEFP	DCSFMS	TDZ	LF	DCON		APMX	Sıkma Vidası Screw Schraube	Baskı Parçası Wedge Clamp Spannpratze	Baskı Vidası Clamp Screw Klemmschraube	Tork Anahtar Torx Key Torx-Schlüssel
AHFMC-JD1204-D32-M16-L43-Z02-H	●	32	2	29	M16	43	17	1.5	JDMW 1204..	4615-M4x11	ACK-05	4015-M4x11	80-T15
AHFMC-JD1204-D42-M16-L43-Z03-H	●	42	3	29	M16	43	17	1.5					

MTSBSH Ucuna Uygundur. / Compatible with MTSBSH Insert. Kompatibel mit MTSBSH Wendepplatten.

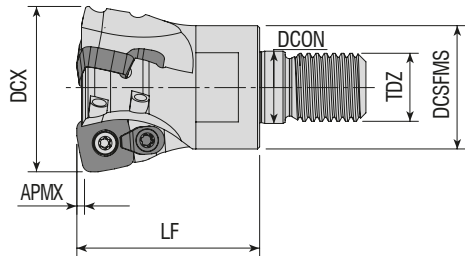

Takım Kodu Ordering Code Bestell-Bezeichnung	Stok Stock Lager	Takım Ölçüleri (mm) Dimension (mm) Abmessung (mm)						Kesici Uç Insert Wendeschneidplatte	Yedek Parçaları / Spare Parts / Ersatzteile				
		DCX	ZEFP	DCSFMS	TDZ	LF	DCON		APMX	Sıkma Vidası Screw Schraube	Baskı Parçası Wedge Clamp Spannpratze	Baskı Vidası Clamp Screw Klemmschraube	Tork Anahtar Torx Key Torx-Schlüssel
AHFMC-SD06T2-D16-M08-L23-Z02-H	●	16	2	14.75	M08	23	8.5	0.8	SD.. 06T2..	3007-M2.2x5	-	-	80-T07
AHFMC-SD06T2-D20-M10-L30-Z03-H	●	20	3	18	M10	30	10.5	0.8					
AHFMC-SD06T2-D25-M12-L35-Z04-H	●	25	4	21	M12	35	12.5	0.8					
AHFMC-SD09T3-D25-M12-L30-Z02-H	●	25	2	22	M12	30	12.5	1.4	SD.. 09T3..	3010-M3.5x9	ACK-15	1510-M3.5x9	80-T10
AHFMC-SD09T3-D32-M16-L43-Z03-H	●	32	3	29	M16	43	17	1.4					
AHFMC-SD09T3-D35-M16-L43-Z03-H	●	35	3	29	M16	43	17	1.4					
AHFMC-SD09T3-D40-M16-L43-Z04-H	●	40	4	29	M16	43	17	1.4					
AHFMC-SD1204-D32-M16-L43-Z02-H	●	32	2	29	M16	43	17	1.8	SD.. 1204..	4015-M4x9			80-T15
AHFMC-SD1204-D40-M16-L43-Z03-H	●	40	3	29	M16	43	17	1.8					

R: Sağ / Right / Rechts L: Sol/Left/Links

● Stokta / In Stock / Auf Lager ○ Stokta Yok / Non Stock Item / Kein Lagerartikel, Lieferzeit auf Anfrage
ZCC Ucuna Uygundur. / Compatible with ZCC Insert. Kompatibel mit ZCC Wendepplatten.

Sipariş Örneği/Ordering Example/Bestellbeispiel

1 ad./pcs./stück AHFMC-JD1204-D32-M16-L43-Z02-H

Kesme Hesabı : S 331 / Cutting Calculation : P 331 / Schnittberechnung : 331

Sıkma Tork Değeri : S 330 / Tightening Torque : P 330 / Anzugsmoment : 330

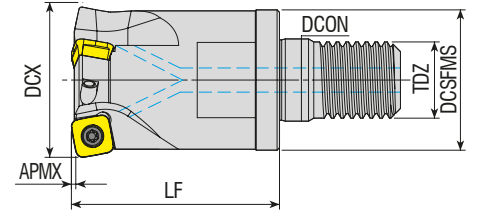

Takım Kodu Ordering Code Bestell-Bezeichnung	Stok Stock Lager	Takım Ölçüleri (mm) Dimension (mm) Abmessung (mm)							Kesici Uç Insert Wendeschneidplatte	Yedek Parçaları / Spare Parts / Ersatzteile			
		DCX	ZEPF	DCSFMS	TDZ	LF	DCON	APMX		Sıkma Vidası Screw Schraube	Baskı Parçası Wedge Clamp Spannpratze	Baskı Vidası Clamp Screw Klemmschraube	Tork Anahtar Torx Key Torx-Schlüssel
AHFM-S00803-D20-M10-L30-Z02-H	●	20	2	18	M10	30	10.5	1	SOMW 0803..				
AHFM-S00803-D25-M12-L35-Z03-H	●	25	3	22	M12	35	12.5	1					
AHFM-S00803-D32-M16-L43-Z03-H	●	32	3	29	M16	43	17	1					
AHFM-S00803-D32-M16-L43-Z04-H	●	32	4	29	M16	43	17	1					
AHFM-S00803-D40-M16-L43-Z04-H	●	40	4	29	M16	43	17	1					

KPTK Ucuna Uygunudur. / Compatible with KPTK Insert. Kompatibel mit KPTK Wendeplatten.

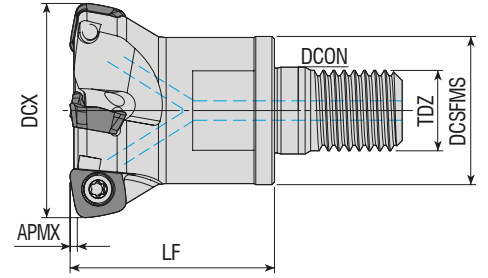

Takım Kodu Ordering Code Bestell-Bezeichnung	Stok Stock Lager	Takım Ölçüleri (mm) Dimension (mm) Abmessung (mm)							Kesici Uç Insert Wendeschneidplatte	Yedek Parçaları / Spare Parts / Ersatzteile			
		DCX	ZEPF	DCSFMS	TDZ	LF	DCON	APMX		Sıkma Vidası Screw Schraube	Baskı Parçası Wedge Clamp Spannpratze	Baskı Vidası Clamp Screw Klemmschraube	Tork Anahtar Torx Key Torx-Schlüssel
AHFM-S01004-D32-M16-L40-Z03-H	●	32	3	29	M16	40	17	1.5	SOMT 1004..				
AHFM-S01004-D40-M16-L40-Z04-H	●	40	4	29	M16	40	17	1.5					
AHFM-S01004-D42-M16-L40-Z04-H	●	42	4	29	M16	40	17	1.5					

R: Sağ / Right / Rechts L: Sol/Left/Links

● Stokta / In Stock / Auf Lager ○ Stokta Yok / Non Stock Item / Kein Lagerartikel, Lieferzeit auf Anfrage
KYCR Ucuna Uygunudur. / Compatible with KYCR Insert. Kompatibel mit KYCR Wendeplatten.

Sipariş Örneği/Ordering Example/Bestellbeispiel

1 ad./pcs./stück AHFM-S00803-D20-M10-L30-Z02-H

Kesme Hesabı : S 331 / Cutting Calculation : P 331 / Schnittberechnung : 331

Sıkma Tork Değeri : S 330 / Tightening Torque : P 330 / Anzugsmoment : 330

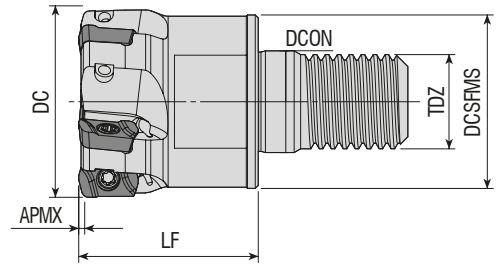

Takım Kodu
Ordering Code
Bestell-Bezeichnung

Takım Kodu Ordering Code Bestell-Bezeichnung	Stok Stock Lager	Takım Ölçüleri (mm) Dimension (mm) Abmessung (mm)						Kesici Uç Insert Wendeschneidplatte	Yedek Parçaları / Spare Parts / Ersatzteile				
		DC	ZEPF	DCSFMS	TDZ	LF	DCON		APMX	Sıkma Vidası Screw Schraube	Baskı Parçası Wedge Clamp Spannpratze	Baskı Vidası Clamp Screw Klemmschraube	Tork Anahtar Torx Key Torx-Schlüssel
AHFM-YP1003-D16-M08-L23-Z02-F	●	16	2	14.75	M08	23	8.5	1	YPHW 1003..	3008-M2.5x5	-	-	80-T08
AHFM-YP1003-D16-M08-L23-Z02-H-F	●	16	2	14.75	M08	23	8.5	1					
AHFM-YP1003-D17-M08-L23-Z02-H	●	17	2	14.75	M08	23	8.5	1					
AHFM-YP1003-D17-M08-L23-Z02-H-F	●	17	2	14.75	M08	23	8.5	1					
AHFM-YP1003-D20-M10-L30-Z03-H	●	20	3	18	M10	30	10.5	1					
AHFM-YP1003-D20-M10-L30-Z03-H-F	●	20	3	18	M10	30	10.5	1					
AHFM-YP1003-D20-M10-L30-Z04-H	●	20	4	18	M10	30	10.5	1					
AHFM-YP1003-D20-M10-L30-Z04-F	●	20	4	18	M10	30	10.5	1					
AHFM-YP1003-D21-M10-L30-Z03-H	●	21	3	18	M10	30	10.5	1					
AHFM-YP1003-D21-M10-L30-Z03-H-F	●	21	3	18	M10	30	10.5	1					
AHFM-YP1003-D25-M12-L35-Z04-H	●	25	4	21	M12	35	12.5	1					
AHFM-YP1003-D25-M12-L35-Z04-F	●	25	4	21	M12	35	12.5	1					
AHFM-YP1003-D25-M12-L35-Z04-H-F	●	25	4	21	M12	35	12.5	1					
AHFM-YP1003-D26-M12-L35-Z04-H-F	●	26	4	21	M12	35	12.5	1					
AHFM-YP1003-D32-M16-L30-Z05-F	●	32	5	29	M16	30	17	1		3008-M2.5x6			
AHFM-YP1003-D32-M16-L43-Z05-H-F	●	32	5	29	M16	43	17	1					
AHFM-YP1003-D40-M16-L43-Z06-H-F	●	40	6	29	M16	43	17	1					
AHFM-YP1003-D42-M16-L43-Z06-H-F	●	42	6	29	M16	43	17	1					

F: Çap toleransı +/- 0.02 mm içerisinde anlamına gelmektedir. / F: Diameter tolerance is between +/- 0.02 mm. / F: Durchmesser-toleranz zwischen +/- 0,02 mm

R: Sağ / Right / Rechts L: Sol/Left/Links

● Stokta / In Stock / Auf Lager ○ Stokta Yok / Non Stock Item / Kein Lagerartikel, Lieferzeit auf Anfrage

DJT Ucuna Uygunudur. / Compatiple with DJT Insert. Kompatibel mit DJT Wendeplatten.

Sipariş Örneği/Ordering Example/Bestellbeispiel

1 ad./pcs./stück AHFM-YP1003-D16-M08-L23-Z02-H

Kesme Hesabı : S 331 / Cutting Calculation : P 331 / Schnittberechnung : 331

Sıkma Tork Değeri : S 330 / Tightening Torque : P 330 / Anzugsmoment : 330



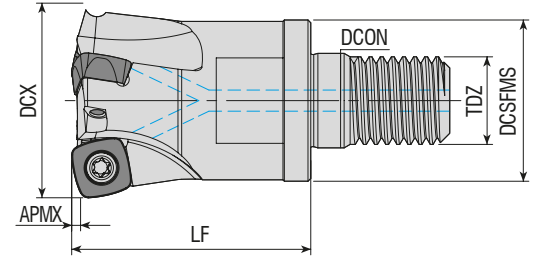

Takım Kodu Ordering Code Bestell-Bezeichnung	Stok Stock Lager	Takım Ölçüleri (mm) Dimension (mm) Abmessung (mm)							Kesici Uç Insert Wendeschneidplatte	Yedek Parçaları / Spare Parts / Ersatzteile			
		DCX	ZEPF	DCSFMS	TDZ	LF	DCON	APMX		Sıkma Vidası Screw Schraube	Baskı Parçası Wedge Clamp Spannpratze	Baskı Vidası Clamp Screw Klemmschraube	Tork Anahtar Torx Key Torx-Schlüssel
AHFM-SP1004-D32-M16-L43-Z03-H	●	32	3	29	M16	43	17	1.5	SPNW 1004..		-	-	80-T15
AHFM-SP1004-D35-M16-L43-Z03-H	●	35	3	29	M16	43	17	1.5					
AHFM-SP1004-D42-M16-L43-Z04-H	●	42	4	29	M16	43	17	1.5					

DJT Ucuna Uygunudur. / Compatible with DJT Insert. Kompatibel mit DJT Wendeplatten.

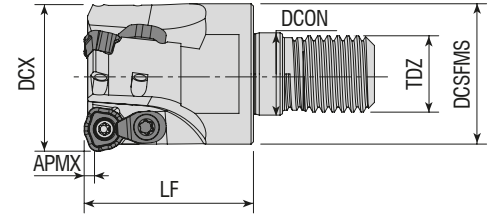

Takım Kodu Ordering Code Bestell-Bezeichnung	Stok Stock Lager	Takım Ölçüleri (mm) Dimension (mm) Abmessung (mm)							Kesici Uç Insert Wendeschneidplatte	Yedek Parçaları / Spare Parts / Ersatzteile			
		DCX	ZEPF	DCSFMS	TDZ	LF	DCON	APMX		Sıkma Vidası Screw Schraube	Baskı Parçası Wedge Clamp Spannpratze	Baskı Vidası Clamp Screw Klemmschraube	Tork Anahtar Torx Key Torx-Schlüssel
AHFMC-WD0804-D25-M12-L35-Z02-H	●	25	2	21	M12	35	12.5	1.5	WDMT 0804..		ACK-15	4010-M3x8	80-T10
AHFMC-WD0804-D32-M16-L35-Z03-H	●	32	3	29	M16	35	17	1.5					

R: Sağ / Right / Rechts L: Sol/Left/Links

● Stokta / In Stock / Auf Lager ○ Stokta Yok / Non Stock Item / Kein Lagerartikel, Lieferzeit auf Anfrage

SMTM Ucuna Uygunudur. / Compatible with SMTM Insert. Kompatibel mit SMTM Wendeplatten.

Sipariş Örneği/Ordering Example/Bestellbeispiel

1 ad./pcs./stück AHFM-SP1004-D32-M16-L43-Z03-H

Kesme Hesabı : S 331 / Cutting Calculation : P 331 / Schnittberechnung : 331

Sıkma Tork Değeri : S 330 / Tightening Torque : P 330 / Anzugsmoment : 330

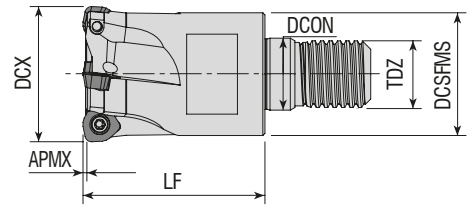

Takım Kodu Ordering Code Bestell-Bezeichnung	Stok Stock Lager	Takım Ölçüleri (mm) Dimension (mm) Abmessung (mm)							Kesici Uç Insert Wendeschneidplatte	Yedek Parçaları / Spare Parts / Ersatzteile			
		DCX	ZEP	DCSFMS	TDZ	LF	DCON	APMX		Sıkma Vidası Screw Schraube	Baskı Parçası Wedge Clamp Spannpratze	Baskı Vidası Clamp Screw Klemmschraube	Tork Anahtar Torx Key Torx-Schlüssel
AHFM-WD0503D-D20-M10-L30-Z02-H	●	20	2	18	M10	30	10.5	1.25	WDMT 0503..	4010-M3x6			80-T10
AHFM-WD0503D-D25-M12-L35-Z03-H	●	25	3	21	M12	35	12.5	1.25		4010-M3x8	-	-	
AHFM-WD0503D-D32-M16-L43-Z04-H	●	32	4	29	M16	43	17	1.25					
AHFM-WD0503D-D40-M16-L43-Z05-H	●	40	5	29	M16	43	17	1.25					
AHFMC-WD06T3D-D35-M16-L43-Z03-H	●	35	3	29	M16	43	17	1.5	WDHW 06T3..	3015-M3.5x9	ACK-15	4015-M3.5x11	80-T15
AHFMC-WD0805D-D32-M16-L43-Z02-H	●	32	2	29	M16	43	17	2	WDHW 0805..	4020-M4.5x10	ACK-19	4020-M4.5x12	

DJT Ucuna Uygun. / Compatible with DJT Insert. Kompatibel mit DJT Wendeplatten.

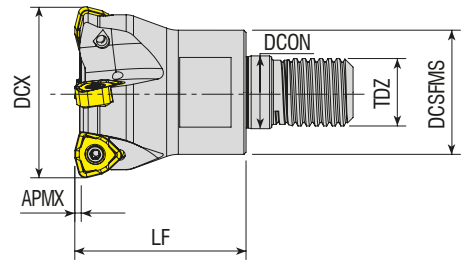

Takım Kodu Ordering Code Bestell-Bezeichnung	Stok Stock Lager	Takım Ölçüleri (mm) Dimension (mm) Abmessung (mm)							Kesici Uç Insert Wendeschneidplatte	Yedek Parçaları / Spare Parts / Ersatzteile		
		DCX	ZEP	DCSFMS	TDZ	LF	DCON	APMX		Sıkma Vidası Screw Schraube	Tork Anahtar Torx Key Torx-Schlüssel	
AHFM-WN09T3-D32-M16-L40-Z03-H	●	32	3	29	M16	40	17	1.5	WNMX 09T3..	4010-M3x8	80-T10	
AHFM-WN09T3-D40-M16-L40-Z04-H	●	40	4	29	M16	40	17	1.5				

R: Sağ / Right / Rechts L: Sol/Left/Links

● Stokta / In Stock / Auf Lager ○ Stokta Yok / Non Stock Item / Kein Lagerartikel, Lieferzeit auf Anfrage

KRLY Ucuna Uygun. / Compatible with KRLY Insert. Kompatibel mit KRLY Wendeplatten.

Sipariş Örneği/Ordering Example/Bestellbeispiel

1 ad./pcs./stück AHFM-WD0503D-D20-M10-L30-Z02-H

Kesme Hesabı : S 331 / Cutting Calculation : P 331 / Schnittberechnung : 331

Sıkma Tork Değeri : S 330 / Tightening Torque : P 330 / Anzugsmoment : 330

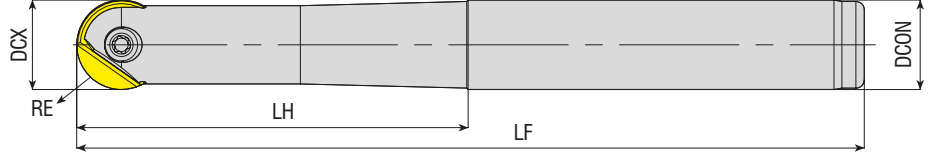

Takım Kodu Ordering Code Bestell-Bezeichnung	Stok Stock Lager	Takım Ölçüleri (mm) Dimension (mm) Abmessung (mm)					Kesici Uç Insert Wendeschneidplatte	Yedek Parçaları / Spare Parts / Ersatzteile	
		DCX	RE	DCON	LF	LH		Sıkma Vidası Screw Schraube	Tork Anahtar Torx Key Torx-Schlüssel
APMR-BNM12-D12-C12-L130	●	12	6	12	130	32			
APMR-BNM16-D16-C16-L175	●	16	8	16	175	70			

DJT Ucuna Uygunudur. / Compatible with DJT Insert. Kompatibel mit DJT Wendepplatten.

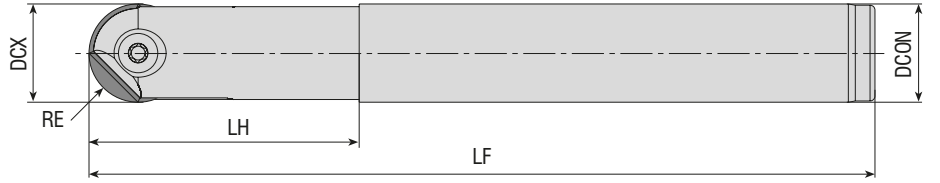

Takım Kodu Ordering Code Bestell-Bezeichnung	Stok Stock Lager	Takım Ölçüleri (mm) Dimension (mm) Abmessung (mm)					Kesici Uç Insert Wendeschneidplatte	Yedek Parçaları / Spare Parts / Ersatzteile	
		DCX	RE	DCON	LF	LH		Sıkma Vidası Screw Schraube	Tork Anahtar Torx Key Torx-Schlüssel
APMR-RO12-D12-C12-L120	●	12	6	12	120	35			
APMR-RO12-D12-C16-L160	●	12	6	16	160	50			
APMR-RO16-D16-C16-L160	●	16	8	16	160	45			
APMR-RO16-D16-C16-L200	●	16	8	16	200	45			
APMR-RO16-D16-C20-L200	●	16	8	20	200	65			
APMR-RO20-D20-C20-L160	●	20	10	20	160	55			
APMR-RO20-D20-C20-L200	●	20	10	20	200	55			
APMR-RO20-D20-C25-L220	●	20	10	25	220	80			

R: Sağ / Right / Rechts L: Sol/Left/Links

● Stokta / In Stock / Auf Lager ○ Stokta Yok / Non Stock Item / Kein Lagerartikel, Lieferzeit auf Anfrage

ZCC Ucuna Uygunudur. / Compatible with ZCC Insert. Kompatibel mit ZCC Wendepplatten.

Sipariş Örneği/Ordering Example/Bestellbeispiel

1 ad./pcs./stück APMR-BNM12-D12-C12-L30

Kesme Hesabı : S 331 / Cutting Calculation : P 331 / Schnittberechnung : 331

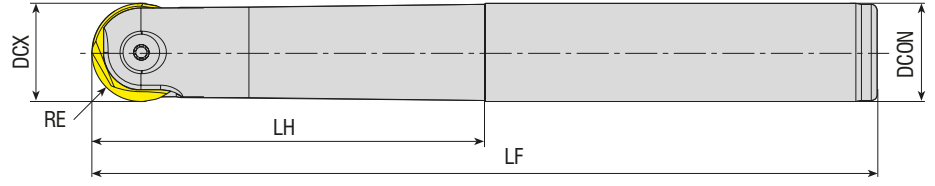

Takım Kodu Ordering Code Bestell-Bezeichnung	Stok Stock Lager	Takım Ölçüleri (mm) Dimension (mm) Abmessung (mm)					Kesici Uç Insert Wendeschneidplatte	Yedek Parçaları / Spare Parts / Ersatzteile	
		DCX	RE	DCON	LF	LH		Sıkma Vidası Screw Schraube	Tork Anahtar Torx Key Torx-Schlüssel
APMR-P3208-D08-C10-L110	●	8	4	10	110	25		1208-M3x7	80-T08
APMR-P3210-D10-C10-L130	●	10	5	10	130	30		1215-M4x0.5x9	80-T15
APMR-P3210-D10-C12-L130	●	10	5	12	130	30		1220-M5x0.5x9	80-T20
APMR-P3212-D12-C12-L130	●	12	6	12	130	32		1220-M5x0.5x12	
APMR-P3216-D16-C16-L175	●	16	8	16	175	60		1220-M5x0.5x15	
APMR-P3220-D20-C20-L200	●	20	10	20	200	100		1220-M6x0.75x20	AAL-05-4
APMR-P3225-D25-C25-L200	●	25	12.5	25	200	100		1204-M8x0.75x26	
APMR-P3232-D32-C32-L200	●	32	16	32	200	100			

WLTR Ucuna Uygun. / Compatible with WLTR Insert. Kompatibel mit WLTR Wendeplatten.

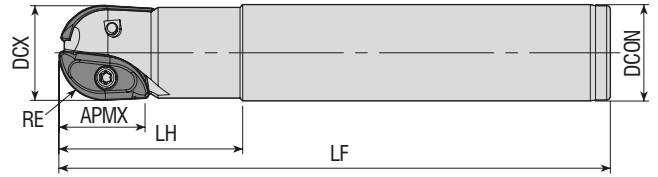

Takım Kodu Ordering Code Bestell-Bezeichnung	Stok Stock Lager	Takım Ölçüleri (mm) Dimension (mm) Abmessung (mm)						Kesici Uç Insert Wendeschneidplatte	Yedek Parçaları / Spare Parts / Ersatzteile	
		DCX	RE	DCON	LF	LH	APMX		Sıkma Vidası Screw Schraube	Tork Anahtar Torx Key Torx-Schlüssel
APMR-XP16-D16-C16-L150	●	16	8	16	150	40	16		3008-M2.5x6	80-T08
APMR-XP20-D20-C20-L150	●	20	10	20	150	50	20		3010-M3.5x9	80-T10
APMR-XP25-D25-C25-L150	●	25	12.5	25	150	50	25		4015-M4x9	80-T15

R: Sağ / Right / Rechts L: Sol/Left/Links

● Stokta / In Stock / Auf Lager ○ Stokta Yok / Non Stock Item / Kein Lagerartikel, Lieferzeit auf Anfrage



ZCC Ucuna Uygun. / Compatible with ZCC Insert. Kompatibel mit ZCC Wendeplatten.

Sipariş Örneği/Ordering Example/Bestellbeispiel

1 ad./pcs./stück APMR-P3208-D08-C10-L110

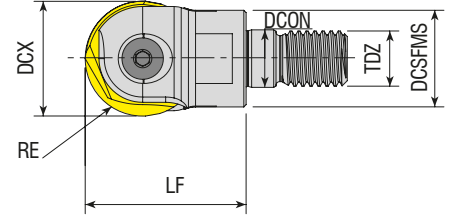

Kesme Hesabı : S 331 / Cutting Calculation : P 331 / Schnittberechnung : 331

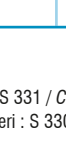

Takım Kodu Ordering Code Bestell-Bezeichnung	Stok Stock Lager	Takım Ölçüleri (mm) Dimension (mm) Abmessung (mm)						Kesici Uç Insert Wendeschneidplatte	Yedek Parçaları / Spare Parts / Ersatzteile		
		DCX	RE	DCSFMS	TDZ	LF	DCON		Sıkma Vidası Screw Schraube	Tork Anahtar Torx Key Torx-Schlüssel	
APMR-P3216-D16-M08-L25	●	16	8	14	M08	25	8.5				
APMR-P3220-D20-M10-L30	●	20	10	18	M10	30	10.5			80-T20	
APMR-P3225-D25-M12-L35	●	25	12.5	21	M12	35	12.5				
APMR-P3232-D32-M16-L43	●	32	16	30	M16	43	17			AAL-05-4	

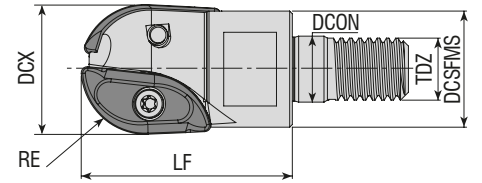
WLTR Ucuna Uygundur. / Compatible with WLTR Insert. Kompatibel mit WLTR Wendeplatten.

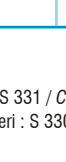

Takım Kodu Ordering Code Bestell-Bezeichnung	Stok Stock Lager	Takım Ölçüleri (mm) Dimension (mm) Abmessung (mm)						Kesici Uç Insert Wendeschneidplatte	Yedek Parçaları / Spare Parts / Ersatzteile		
		DCX	RE	DCSFMS	TDZ	LF	DCON		Sıkma Vidası Screw Schraube	Tork Anahtar Torx Key Torx-Schlüssel	
APMR-SWB225-D25-M12-L35	●	25	12.5	23.5	M12	35	12.5				
APMR-SWB230-D30-M16-L43	●	30	15	28	M16	43	17			80-T15	
APMR-SWB232-D32-M16-L43	●	32	16	30	M16	43	17			80-T20	

R: Sağ / Right / Rechts L: Sol/Left/Links

● Stokta / In Stock / Auf Lager ○ Stokta Yok / Non Stock Item / Kein Lagerartikel, Lieferzeit auf Anfrage

DJT Ucuna Uygundur. / Compatible with DJT Insert. Kompatibel mit DJT Wendeplatten.

Sipariş Örneği/Ordering Example/Bestellbeispiel

1 ad./pcs./stück APMR-P3216-D16-M08-L25

Kesme Hesabı : S 331 / Cutting Calculation : P 331 / Schnittberechnung : 331

Sıkma Tork Değeri : S 330 / Tightening Torque : P 330 / Anzugsmoment : 330

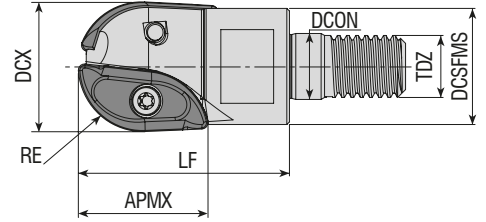

Takım Kodu Ordering Code Bestell-Bezeichnung	Stok Stock Lager	Takım Ölçüleri (mm) Dimension (mm) Abmessung (mm)							Kesici Uç Insert Wendeschneidplatte	Yedek Parçaları / Spare Parts / Ersatzteile		
		DCX	RE	DCSFMS	TDZ	LF	APMX	DCON		Sıkma Vidası Screw Schraube	Tork Anahtar Torx Key Torx-Schlüssel	
APMR-XP16-D16-M08-L25	●	16	8	14.75	M08	25	16	8.5				
APMR-XP20-D20-M10-L30	●	20	10	18	M10	30	20	10.5	XPHT 20R10T3	3010-M3.5x9	80-T10	
APMR-XP25-D25-M12-L40	●	25	12.5	22	M12	40	25	12.5	XPHT 25R1204	4015-M4x9	80-T15	

ZCC Ucuna Uygunudur. / Compatible with ZCC Insert. Kompatibel mit ZCC Wendeplatten.

VİDALI TAKIM TUTUCULARI
SCREWED TOOL HOLDERS
AUFNAHME FÜR EINSCHRAUBFRÄSER

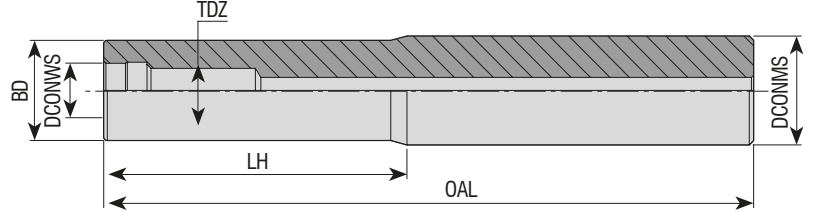

Takım Kodu Ordering Code Bestell-Bezeichnung	Stok Stock Lager	Takım Ölçüleri (mm) Dimension (mm) Abmessung (mm)					
		DCONMS	TDZ	DCONWS	BD	OAL	LH
AVTT-D13-C16-M08-L100-H	●	16	M08	8.5	13	100	40
AVTT-D15-C16-M08-L130-H	●	16	M08	8.5	15	130	70
AVTT-D18-C20-M10-L130-H	●	20	M10	10.5	18	130	70
AVTT-D18-C20-M10-L160-H	●	20	M10	10.5	18	160	80
AVTT-D23-C25-M12-L150-H	●	25	M12	12.5	23	150	70
AVTT-D23-C25-M12-L200-H	●	25	M12	12.5	23	200	100
AVTT-D23-C25-M12-L250-H	●	25	M12	12.5	23	250	150
AVTT-D30-C32-M16-L150-H	●	32	M16	17	30	150	70
AVTT-D30-C32-M16-L200-H	●	32	M16	17	30	200	100
AVTT-D30-C32-M16-L250-H	●	32	M16	17	30	250	150
AVTT-D30-C32-M16-L300-H	●	32	M16	17	30	300	200

R: Sağ / Right / Rechts L: Sol/Left/Links

● Stokta / In Stock / Auf Lager ○ Stokta Yok / Non Stock Item / Kein Lagerartikel, Lieferzeit auf Anfrage

Sipariş Örneği/Ordering Example/Bestellbeispiel
1 ad./pcs./stück APMR-XP16-D16-M08-L25

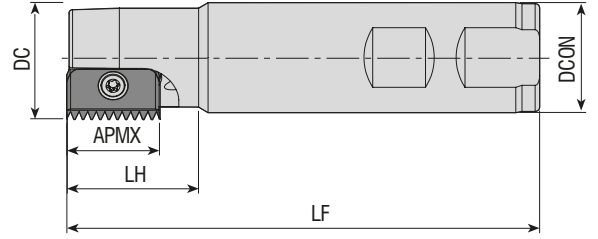

Takım Kodu Ordering Code Bestell-Bezeichnung	Stok Stock Lager	Takım Ölçüleri (mm) Dimension (mm) Abmessung (mm)						Kesici Uç Insert Wendeschneidplatte	Yedek Parçaları / Spare Parts / Ersatzteile	
		DC	ZEPF	DCON	LF	LH	APMX		Sıkma Vidası Screw Schraube	Tork Anahtar Torx Key Torx-Schlüssel
ATM-C14-D14-W20-L100-Z01-H	●	14	1	20	100	25	14	C14	3008-M2.5x6	80-T08
ATM-C21-D18-W20-L100-Z01-H	●	18	1	20	100	30	21		4015-M4x9	
ATM-C21-D21-W25-L125-Z01-H	●	21	1	25	125	40	21	C21	4015-M4x11	80-T15
ATM-C21-D25-W20-L125-Z01-H	●	25	1	20	125	30	21			
ATM-C21-D28-W25-L90-Z01-H	●	28	1	25	90	30	21			
ATM-C21-D38-W32-L90-Z03-H	●	38	3	32	90	30	21			
ATM-C21-D38-W32-L120-Z03-H	●	38	3	32	120	30	21			
ATM-C21-D43-W32-L90-Z03-H	●	43	3	32	90	30	21	C30	1020-M5x14	80-T20
ATM-C30-D29-W25-L150-Z01-H	●	29	1	25	150	50	30			

CPT Ucuna Uygundur. / Compatible with CPT Insert. Kompatibel mit CPT Wendeplatten.

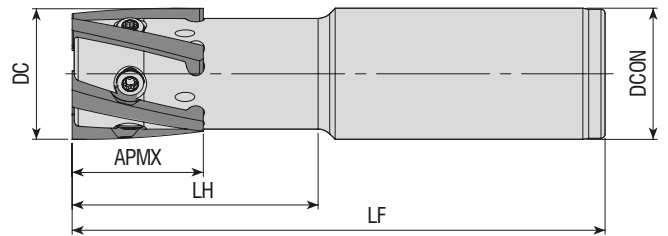

Takım Kodu Ordering Code Bestell-Bezeichnung	Stok Stock Lager	Takım Ölçüleri (mm) Dimension (mm) Abmessung (mm)						Kesici Uç Insert Wendeschneidplatte	Yedek Parçaları / Spare Parts / Ersatzteile	
		DC	ZEPF	DCON	LF	LH	APMX		Sıkma Vidası Screw Schraube	Tork Anahtar Torx Key Torx-Schlüssel
ATM-H23-D23-C25-L100-Z02-H	●	23	2	25	100	30	27	H23	1015-M4x8	80-T15
ATM-H32-D32-C32-L130-Z05-H	●	32	5	32	130	35	32		1720-U8-32x10	

R: Sağ / Right / Rechts L: Sol/Left/Links

● Stokta / In Stock / Auf Lager ○ Stokta Yok / Non Stock Item / Kein Lagerartikel, Lieferzeit auf Anfrage
CPT Ucuna Uygundur. / Compatible with CPT Insert. Kompatibel mit CPT Wendeplatten.

Sipariş Örneği/Ordering Example/Bestellbeispiel

1 ad./pcs./stück ATM-C14-D14-W20-L100-Z01-H

Kesme Hesabı : S 331 / Cutting Calculation : P 331 / Schnittberechnung : 331

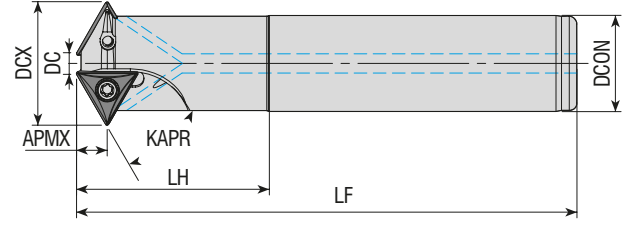

Takım Kodu
Ordering Code
Bestell-Bezeichnung

Stok
Stock
Lager

Takım Ölçüleri (mm)
Dimension (mm)
Abmessung (mm)

Kesici Uç
Insert
Wendeschneidplatte

Yedek Parçaları / Spare Parts / Ersatzteile

Sıkma Vidası
Screw
Schraube

Tork Anahtar
Torx Key
Torx-Schlüssel

ATM60-TB0601-D13-C10-L150-Z02-H	●	60	13	10	2.5	150	40	2	3.3	TBGT 060102	3006-M2x4	80-T06
ATM60-TC0902-D20.5-C16-L150-Z02-H	●	60	20.5	16	5.2	150	40	2	4.7	TC.T 090202	3007-M2.2x5	80-T07
ATM60-TC1102-D26-C20-L150-Z03-H	●	60	26	20	8.3	150	50	3	5.4	TC.T 110202	3008-M2.5x6	80-T08
ATM60-TC16T3-D32-C25-L150-Z02-H	●	60	32	25	6.4	150	50	2	8	TC.T 16T304	4015-M3.5x9	80-T15
ATM60-TC16T3-D40-C32-L250-Z03-H	●	60	40	32	13.7	250	50	3	8			

ISO Ucuna Uygun. / Compatible with ISO Insert. Kompatibel mit ISO Wendepplatten.

S-SİSTEM HELİS FREZELER
S-SYSTEM HELIX END MILL
S-SYSTEM WENDELSCHAFTFRÄSER

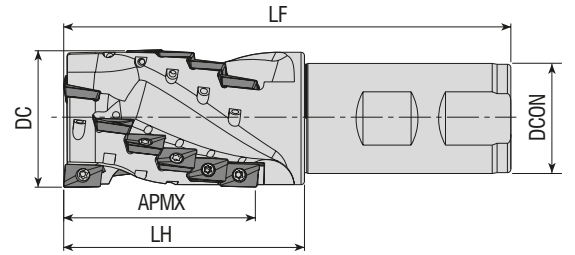
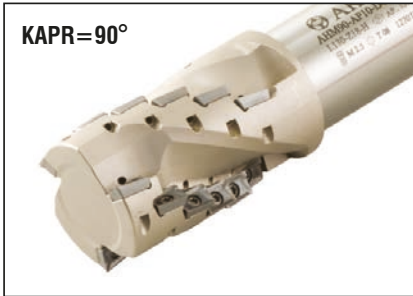

Takım Kodu
Ordering Code
Bestell-Bezeichnung

Stok
Stock
Lager

Takım Ölçüleri (mm)
Dimension (mm)
Abmessung (mm)

Kesici Uç
Insert
Wendeschneidplatte

Yedek Parçaları / Spare Parts / Ersatzteile

Sıkma Vidası
Screw
Schraube

Tork Anahtar
Torx Key
Torx-Schlüssel

	Stok Stock Lager	ZEFP		DC	DCON	APMX	LH	LF	Kesici Uç Insert Wendeschneidplatte	Sıkma Vidası Screw Schraube	Tork Anahtar Torx Key Torx-Schlüssel
		Toplam Total Gesamt	Etkili Effective Effektiv								
AHM90-AP10-D20-W20-L087-Z0204	●	4	2	20	20	28	37	87	AP. 1003..	3008-M2.5x6	80-T08
AHM90-AP10-D20-W20-L087-Z0206	●	6	2	20	20	28	37	87			
AHM90-AP10-D25-W25-L105-Z0208-H	●	8	2	25	25	37	50	105			
AHM90-AP10-D32-W32-L115-Z0315-H	●	15	3	32	32	46	55	115			
AHM90-AP10-D40-W32-L130-Z0318-H	●	18	3	40	32	55	70	130			

R: Sağ / Right / Rechts L: Sol/Left/Links

● Stokta / In Stock / Auf Lager ○ Stokta Yok / Non Stock Item / Kein Lagerartikel, Lieferzeit auf Anfrage
ISO Ucuna Uygun. / Compatible with ISO Insert. Kompatibel mit ISO Wendepplatten.

Sipariş Örneği/Ordering Example/Bestellbeispiel
1 ad./pcs./stück ATM60-TB0601-D13-C10-L150-Z02-H
Kesme Hesabı : S 331 / Cutting Calculation : P 331 / Schnittberechnung : 331

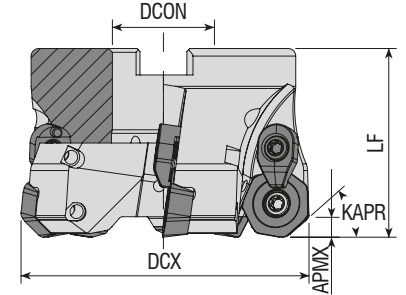

Takım Kodu Ordering Code Bestell-Bezeichnung	Stok Stock Lager	Takım Ölçüleri (mm) Dimension (mm) Abmessung (mm)					Kesici Uç Insert Wendeschneidplatte	Yedek Parçaları / Spare Parts / Ersatzteile					
		DCX	ZEFP	DCON	LF	APMX		Sıkma Vidası Screw Schraube	Baskı Parçası Wedge Clamp Spannpratze	Baskı Vidası Clamp Screw Klemmschraube	Tork Anahtar Torx Key Torx-Schlüssel	Montaj Vidası Mounting Screw Befestigungsschraube	
AFM42C-XD0806-D063-A27-Z04-H	●	63	4	27	50	12	XDMW 0806..	4020-M4.5x12	ACK-24	4020-M4.5x12	80-T20	2510-M12x35	
AFM42C-XD0806-D080-A27-Z05-H	●	80	5	27	50	12							
AFM42C-XD0806-D100-A32-Z06-H	●	100	6	32	63	12							2514-M16x35
AFM42C-XD0806-D125-B40-Z07	●	125	7	40	63	12							-
AFM42C-XD0806-D160-C40-Z08	●	160	8	40	63	12							-
AFM42C-XD0806-D200-C60-Z09	●	200	9	60	63	12							-

DJT Ucuna Uygunudur. / Compatible with DJT Insert. Kompatibel mit DJT Wendeplatten.

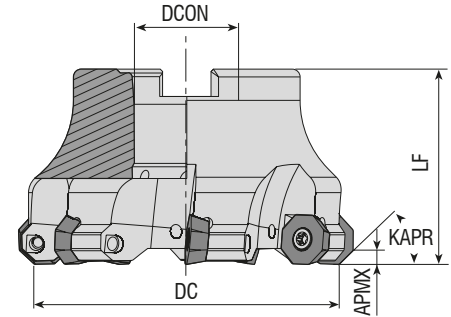

Takım Kodu Ordering Code Bestell-Bezeichnung	Stok Stock Lager	Takım Ölçüleri (mm) Dimension (mm) Abmessung (mm)					Kesici Uç Insert Wendeschneidplatte	Yedek Parçaları / Spare Parts / Ersatzteile			
		DC	ZEFP	DCON	LF	APMX		Sıkma Vidası Screw Schraube	Tork Anahtar Torx Key Torx-Schlüssel	Montaj Vidası Mounting Screw Befestigungsschraube	
AFM43-OD0504-D040-A16-Z04-H	●	40	4	16	40	3.5	OD.. 0504..	4015-M3.5x11	80-T15	2506-M8x30	
AFM43-OD0504-D050-A22-Z05-H	●	50	5	22	40	3.5					
AFM43-OD0504-D063-A22-Z06-H	●	63	6	22	40	3.5					2407-M10x30
AFM43-OD0504-D080-A27-Z07-H	●	80	7	27	50	3.5					2510-M12x35
AFM43-OD0504-D100-A32-Z08-H	●	100	8	32	50	3.5					2514-M16x35

R: Sağ / Right / Rechts L: Sol/Left/Links

● Stokta / In Stock / Auf Lager ○ Stokta Yok / Non Stock Item / Kein Lagerartikel, Lieferzeit auf Anfrage
WLTR Ucuna Uygunudur. / Compatible with WLTR Insert. Kompatibel mit WLTR Wendeplatten.

Sipariş Örneği/Ordering Example/Bestellbeispiel

1 ad./pcs./stück AFM42C-XD0806-D063-A27-Z04-H

Kesme Hesabı : S 331 / Cutting Calculation : P 331 / Schnittberechnung : 331

Montaj Ölçüleri : S 328 / Mounting Reference : P 328 / Montagehinweis : 328

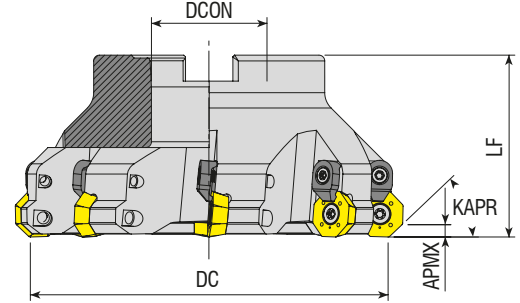

Takım Kodu Ordering Code Bestell-Bezeichnung	Stok Stock Lager	Takım Ölçüleri (mm) Dimension (mm) Abmessung (mm)					Kesici Uç Insert Wendeschneidplatte	Yedek Parçaları / Spare Parts / Ersatzteile									
		DC	ZEFP	DCON	LF	APMX		Sıkma Vidası Screw Schraube	Baskı Parçası Wedge Clamp Spannpratze	Baskı Vidası Clamp Screw Klemmschraube	Tork Anahtar Torx Key Torx-Schlüssel	Montaj Vidası Mounting Screw Befestigungsschraube					
AFM43C-OD0605-D080-A27-Z06-H	●	80	6	27	50	4	OD.. 0605..										
AFM43C-OD0605-D100-A32-Z07-H	●	100	7	32	50	4							1020-M5x11	ACK-05	4015-M4x11	80-T20	2510-M12x35
AFM43C-OD0605-D125-B40-Z08	●	125	8	40	63	4							-	-	-	-	-

WLTR-LMN Ucuna Uygun. / Compatible with WLTR-LMN Insert. Kompatibel mit WLTR-LMN Wendeplatten.

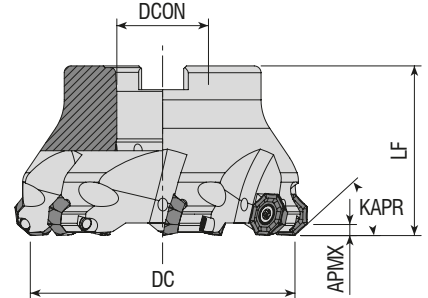

Takım Kodu Ordering Code Bestell-Bezeichnung	Stok Stock Lager	Takım Ölçüleri (mm) Dimension (mm) Abmessung (mm)					Kesici Uç Insert Wendeschneidplatte	Yedek Parçaları / Spare Parts / Ersatzteile					
		DC	ZEFP	DCON	LF	APMX		Sıkma Vidası Screw Schraube	Tork Anahtar Torx Key Torx-Schlüssel	Montaj Vidası Mounting Screw Befestigungsschraube			
AFM43-OF05T3-D050-A22-Z05-H	●	50	5	22	40	3	OF.. 05T3..						
AFM43-OF05T3-D063-A22-Z06-H	●	63	6	22	40	3					4015-M4x9	80-T15	2407-M10x30
AFM43-OF05T3-D080-A27-Z07-H	●	80	7	27	50	3					4015-M4x11		2510-M12x35
AFM43-OF05T3-D125-B40-Z09	●	125	9	40	63	3					-		-

R: Sağ / Right / Rechts L: Sol/Left/Links
● Stokta / In Stock / Auf Lager ○ Stokta Yok / Non Stock Item / Kein Lagerartikel, Lieferzeit auf Anfrage
ISO Ucuna Uygun. / Compatible with ISO Insert. Kompatibel mit ISO Wendeplatten.

Sipariş Örneği/Ordering Example/Bestellbeispiel
1 ad./pcs./stück AFM43C-OD0605-D080-A27-Z06-H
Kesme Hesabı : S 331 / Cutting Calculation : P 331 / Schnittberechnung : 331
Montaj Ölçüleri : S 328 / Mounting Reference : P 328 / Montagehinweis : 328

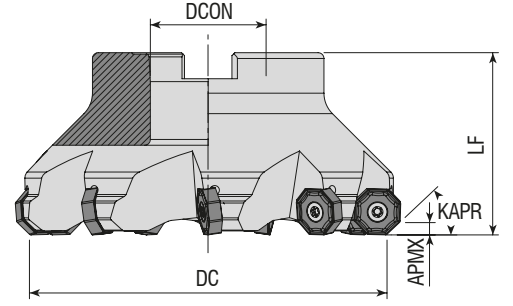

Takım Kodu Ordering Code Bestell-Bezeichnung	Stok Stock Lager	Takım Ölçüleri (mm) Dimension (mm) Abmessung (mm)					Kesici Uç Insert Wendeschneidplatte	Yedek Parçaları / Spare Parts / Ersatzteile		
		DC	ZEFP	DCON	LF	APMX		Sıkma Vidası Screw Schraube	Tork Anahtar Torx Key Torx-Schlüssel	Montaj Vidası Mounting Screw Befestigungsschraube
AFM43-ON0604-D050-A22-Z05-H	●	50	5	22	40	4	ON.. 0604..	4015-M4x11	80-T15	2407-M10x30
AFM43-ON0604-D063-A22-Z06-H	●	63	6	22	40	4				
AFM43-ON0604-D080-A27-Z07-H	●	80	7	27	50	4				
AFM43-ON0604-D100-A32-Z08-H	●	100	8	32	50	4				
AFM43-ON0604-D125-B40-Z09	●	125	9	40	63	4				

ZCC Ucuna Uygunur. / Compatible with ZCC Insert. Kompatibel mit ZCC Wendeplatten.

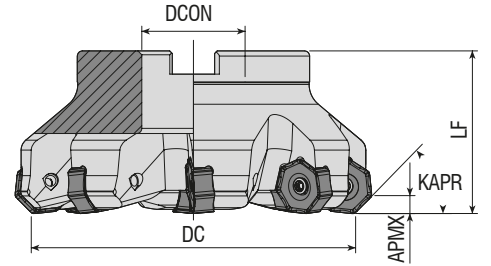

Takım Kodu Ordering Code Bestell-Bezeichnung	Stok Stock Lager	Takım Ölçüleri (mm) Dimension (mm) Abmessung (mm)					Kesici Uç Insert Wendeschneidplatte	Yedek Parçaları / Spare Parts / Ersatzteile		
		DC	ZEFP	DCON	LF	APMX		Sıkma Vidası Screw Schraube	Tork Anahtar Torx Key Torx-Schlüssel	Montaj Vidası Mounting Screw Befestigungsschraube
AFM44-ON0606-D063-A22-Z06-H	●	63	6	22	40	3.8	ONHX 0606..	4020-M4.5x12	80-T20	2407-M10x30
AFM44-ON0606-D080-A27-Z08-H	●	80	8	27	50	3.8				
AFM44-ON0606-D100-A32-Z10-H	●	100	10	32	50	3.8				

R: Sağ / Right / Rechts L: Sol/Left/Links

● Stokta / In Stock / Auf Lager ○ Stokta Yok / Non Stock Item / Kein Lagerartikel, Lieferzeit auf Anfrage
KRLY Ucuna Uygunur. / Compatible with KRLY Insert. Kompatibel mit KRLY Wendeplatten.

Sipariş Örneği/Ordering Example/Bestellbeispiel

1 ad./pcs./stück AFM43-ON0604-D050-A22-Z05-H

Kesme Hesabı : S 331 / Cutting Calculation : P 331 / Schnittberechnung : 331

Montaj Ölçüleri : S 328 / Mounting Reference : P 328 / Montagehinweis : 328

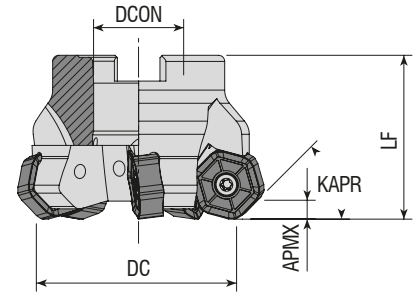

Takım Kodu Ordering Code Bestell-Bezeichnung	Stok Stock Lager	Takım Ölçüleri (mm) Dimension (mm) Abmessung (mm)					Kesici Uç Insert Wendeschneidplatte	Yedek Parçaları / Spare Parts / Ersatzteile			
		DC	ZEFP	DCON	LF	APMX		Sıkma Vidası Screw Schraube	Tork Anahtar Torx Key Torx-Schlüssel	Montaj Vidası Mounting Screw Befestigungsschraube	
AFM45-HN0905-D050-A22-Z05-H	●	50	5	22	40	4.5	HN.. 0905..	4015-M4x11	80-T15	-	
AFM45-HN0905-D063-A22-Z06-H	●	63	6	22	40	4.5					2407-M10x30
AFM45-HN0905-D080-A27-Z07-H	●	80	7	27	50	4.5					2510-M12x35
AFM45-HN0905-D125-B40-Z10	●	125	10	40	63	4.5					
AFM45-HN0905-D160-C40-Z12	●	160	12	40	63	4.5					
AFM45L-HN0905-D160-C40-Z12	●	160	12	40	63	4.5					
AFM45-HN0905-D200-C60-Z16	●	200	16	60	63	4.5					
AFM45-HN0905-D200-C60-Z16	●	200	16	60	63	5.5					
AFM45L-HN0905-D200-C60-Z16	●	200	16	60	63	4.5					

WDA Ucuna Uygundur. / Compatible with WDA Insert. Kompatibel mit WDA Wendeplatten.

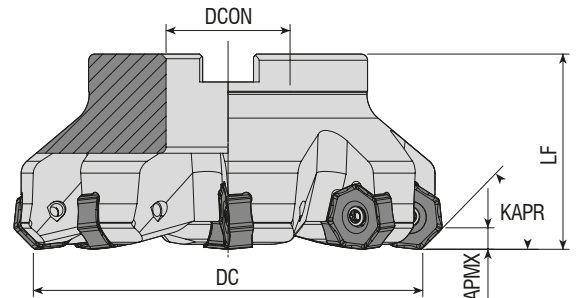

Takım Kodu Ordering Code Bestell-Bezeichnung	Stok Stock Lager	Takım Ölçüleri (mm) Dimension (mm) Abmessung (mm)					Kesici Uç Insert Wendeschneidplatte	Yedek Parçaları / Spare Parts / Ersatzteile			
		DC	ZEFP	DCON	LF	APMX		Sıkma Vidası Screw Schraube	Tork Anahtar Torx Key Torx-Schlüssel	Montaj Vidası Mounting Screw Befestigungsschraube	
AFM45-NN2007-D100-A32-Z07-H	●	100	7	32	50	6	NNMU 2007..	1020-M5x14	80-T20	2514-M16x35	
AFM45-NN2007-D125-B40-Z08	●	125	8	40	63	6					
AFM45-NN2007-D160-C40-Z10	●	160	10	40	63	6					

R: Sağ / Right / Rechts L: Sol/Left/Links
● Stokta / In Stock / Auf Lager ○ Stokta Yok / Non Stock Item / Kein Lagerartikel, Lieferzeit auf Anfrage
MTSBSH Ucuna Uygundur. / Compatible with MTSBSH Insert. Kompatibel mit MTSBSH Wendeplatten.

Sipariş Örneği/Ordering Example/Bestellbeispiel
1 ad./pcs./stück AFM45-HN0905-D063-A22-Z06-H
Kesme Hesabı : S 331 / Cutting Calculation : P 331 / Schnittberechnung : 331
Montaj Ölçüleri : S 328 / Mounting Reference : P 328 / Montagehinweis : 328

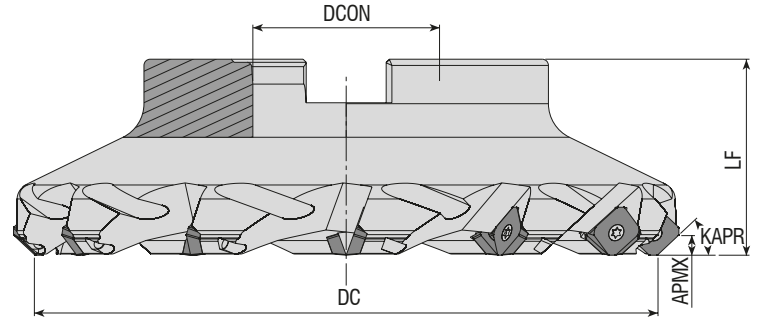

Takım Kodu Ordering Code Bestell-Bezeichnung	Stok Stock Lager	Takım Ölçüleri (mm) Dimension (mm) Abmessung (mm)					Kesici Uç Insert Wendeschneidplatte	Yedek Parçaları / Spare Parts / Ersatzteile			
		DC	ZEPF	DCON	LF	APMX		Sıkma Vidası Screw Schraube	Tork Anahtar Torx Key Torx-Schlüssel	Montaj Vidası Mounting Screw Befestigungsschraube	
AFM45-SE12-D050-A22-Z04-H	●	50	4	22	40	6	SE.. 12T3.. R245-12T3..	4015-M3.5x11	80-T15	2407-M10x30	
AFM45L-SE12-D050-A22-Z04-H	●	50	4	22	40	6					
AFM45-SE12-D063-A22-Z05-H	●	63	5	22	40	6					
AFM45L-SE12-D063-A22-Z05-H	●	63	5	22	40	6					
AFM45-SE12-D080-A27-Z06-H	●	80	6	27	50	6					
AFM45L-SE12-D080-A27-Z06-H	●	80	6	27	50	6					
AFM45-SE12-D100-A32-Z07-H	●	100	7	32	50	6					
AFM45-SE12-D125-B40-Z08	●	125	8	40	63	6					
AFM45-SE12-D160-C40-Z10	●	160	10	40	63	6					
AFM45L-SE12-D160-C40-Z10	●	160	10	40	63	6					
AFM45-SE12-D200-C60-Z12	●	200	12	60	63	6	-	-	-		

ZCC-SNDVK Ucuna Uygun. / Compatible with ZCC-SNDVK Insert. Kompatibel mit ZCC-SNDVK Wendeplatten.

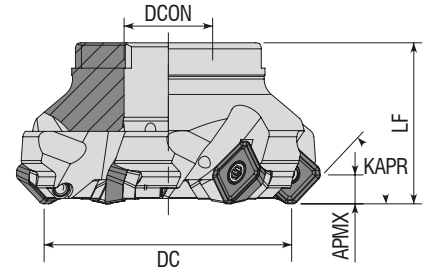

Takım Kodu Ordering Code Bestell-Bezeichnung	Stok Stock Lager	Takım Ölçüleri (mm) Dimension (mm) Abmessung (mm)					Kesici Uç Insert Wendeschneidplatte	Yedek Parçaları / Spare Parts / Ersatzteile				
		DC	ZEPF	DCON	LF	APMX		Altık Screw Unterlage	Altık Vidası Wedge Clamp Schraube für Unterlage	Sıkma Vidası Screw Schraube	Tork Anahtar Torx Key Torx-Schlüssel	Montaj Vidası Mounting Screw Befestigungsschraube
AFM45-SE13-D050-A22-Z04-H	●	50	4	22	40	6	SEMT 13T3..	AASE-3-0001	AAV-16-M3.5x8	4015-M3.5x11	80-T15	2407-M10x30
AFM45-SE13-D063-A22-Z05-H	●	63	5	22	40	6						
AFM45-SE13-D080-A27-Z06-H	●	80	6	27	50	6						
AFM45S-SE13-D050-A22-Z05-H	●	50	5	22	40	6						
AFM45S-SE13-D063-A22-Z06-H	●	63	6	22	40	6						
AFM45S-SE13-D080-A27-Z08-H	●	80	8	27	50	6						
AFM45S-SE13-D100-A32-Z10-H	●	100	10	32	50	6						
AFM45S-SE13-D125-B40-Z12	●	125	12	40	63	6						

R: Sağ / Right / Rechts L: Sol/Left/Links

● Stokta / In Stock / Auf Lager ○ Stokta Yok / Non Stock Item / Kein Lagerartikel, Lieferzeit auf Anfrage

SMTM-DJT Ucuna Uygun. / Compatible with SMTM-DJT Insert. Kompatibel mit SMTM-DJT Wendeplatten.

Sipariş Örneği/Ordering Example/Bestellbeispiel

1 ad./pcs./stück AFM45-SE12-D050-A22-Z04-H

Kesme Hesabı : S 331 / Cutting Calculation : P 331 / Schnittberechnung : 331

Montaj Ölçüleri : S 328 / Mounting Reference : P 328 / Montagehinweis : 328

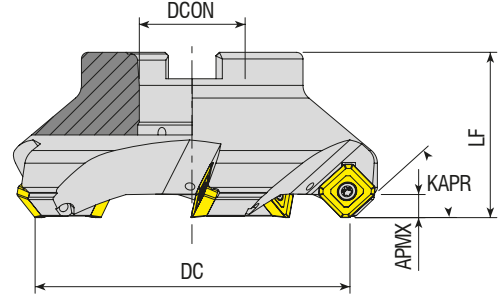

Takım Kodu Ordering Code Bestell-Bezeichnung	Stok Stock Lager	Takım Ölçüleri (mm) Dimension (mm) Abmessung (mm)					Kesici Uç Insert Wendeschneidplatte	Yedek Parçaları / Spare Parts / Ersatzteile			
		DC	ZEFP	DCON	LF	APMX		Sıkma Vidası Screw Schraube	Tork Anahtar Torx Key Torx-Schlüssel	Montaj Vidası Mounting Screw Befestigungsschraube	
AFM45-SE14M4-D063-A22-Z04-H	●	63	4	22	40	7	SE.. 14M4..	4015-M3.5x11	80-T15	-	2407-M10x30
AFM45-SE14M4-D080-A27-Z05-H	●	80	5	27	50	7					2510-M12x35
AFM45-SE14M4-D100-A32-Z05-H	●	100	5	32	50	7					2514-M16x35
AFM45-SE14M4-D125-B40-Z06	●	125	6	40	63	7					-
AFM45-SE14M4-D160-C40-Z07	●	160	7	40	63	7					-

KRLY Ucuna Uygun. / Compatible with KRLY Insert. Kompatibel mit KRLY Wendepalten.

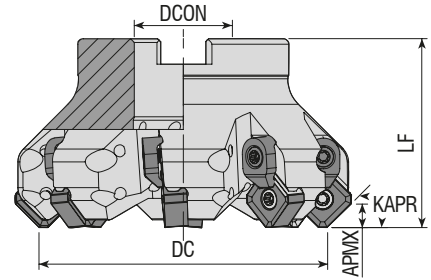

Takım Kodu Ordering Code Bestell-Bezeichnung	Stok Stock Lager	Takım Ölçüleri (mm) Dimension (mm) Abmessung (mm)					Kesici Uç Insert Wendeschneidplatte	Yedek Parçaları / Spare Parts / Ersatzteile					
		DC	ZEFP	DCON	LF	APMX		Sıkma Vidası Screw Schraube	Baskı Parçası Wedge Clamp Spannpratze	Baskı Vidası Clamp Screw Klemmschraube	Tork Anahtar Torx Key Torx-Schlüssel	Montaj Vidası Mounting Screw Befestigungsschraube	
AFM45C-SN12..-D050-A22-Z04-H	●	50	4	22	42	6	SN.. 12..	1015-M4x11	ACK-05	4015-M4x11	80-T15	-	
AFM45C-SN12..-D050-A22-Z05-H	●	50	5	22	42	6							
AFM45C-SN12..-D063-A22-Z06-H	●	63	6	22	42	6							2407-M10X30
AFM45C-SN12..-D063-A22-Z07-H	●	63	7	22	42	6							
AFM45CL-SN12..-D063-A22-Z07-H	●	63	7	22	42	6							
AFM45C-SN12..-D080-A27-Z07-H	●	80	7	27	52	6							
AFM45C-SN12..-D080-A27-Z08-H	●	80	8	27	52	6							2510-M12x35
AFM45CL-SN12..-D080-A27-Z08-H	●	80	8	27	52	6							
AFM45C-SN12..-D100-A32-Z08-H	●	100	8	32	52	6							
AFM45C-SN12..-D100-A32-Z10-H	●	100	10	32	52	6							2514-M16x35
AFM45CL-SN12..-D100-A32-Z10-H	●	100	10	32	52	6							
AFM45C-SN12..-D125-B40-Z11	●	125	11	40	65	6							
AFM45CL-SN12..-D125-B40-Z11	●	125	11	40	65	6							
AFM45C-SN12..-D160-C40-Z12	●	160	12	40	65	6							
AFM45C-SN12..-D200-C60-Z14	●	200	14	60	65	6							
AFM45CL-SN12..-D200-C60-Z14	●	200	14	60	65	6							

R: Sağ / Right / Rechts L: Sol/Left/Links

● Stokta / In Stock / Auf Lager ○ Stokta Yok / Non Stock Item / Kein Lagerartikel, Lieferzeit auf Anfrage

WLTR-LMN-ACHTK Ucuna Uygun. / Compatible with WLTR-LMN-ACHTK Insert. Kompatibel mit WLTR-LMN-ACHTK Wendepalten.

Montaj Ölçüleri : S 328 / Mounting Reference : P 328 / Montagehinweis : 328

Sipariş Örneği/Ordering Example/Bestellbeispiel

1 ad./pcs./stück AFM45-SE14M4-D063-A22-Z04-H

Kesme Hesabı : S 331 / Cutting Calculation : P 331 / Schnittberechnung : 331

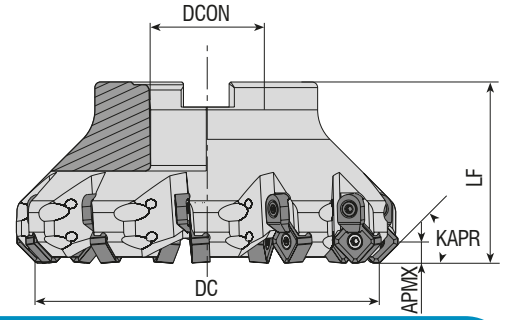

Takım Kodu Ordering Code Bestell-Bezeichnung	Stok Stock Lager	Takım Ölçüleri (mm) Dimension (mm) Abmessung (mm)					Kesici Uç Insert Wendeschneidplatte	Yedek Parçaları / Spare Parts / Ersatzteile					
		DC	ZEFP	DCON	LF	APMX		Sıkma Vidası Screw Schraube	Baskı Parçası Wedge Clamp Spannpratze	Baskı Vidası Clamp Screw Klemmschraube	Tork Anahtar Torx Key Torx-Schlüssel	Montaj Vidası Mounting Screw Befestigungsschraube	
AFM45C-SN1206-D050-A22-Z04-H	●	50	4	22	42	6	SN.. 1206..						
AFM45CL-SN1206-D050-A22-Z05-H	●	50	5	22	42	6							
AFM45C-SN1206-D050-A22-Z05-H	●	50	5	22	42	6							
AFM45C-SN1206-D063-A22-Z06-H	●	63	6	22	42	6							2407-M10x30
AFM45C-SN1206-D063-A22-Z07-H	●	63	7	22	42	6							
AFM45CL-SN1206-D063-A22-Z07-H	●	63	7	22	42	6							
AFM45C-SN1206-D080-A27-Z07-H	●	80	7	27	52	6							
AFM45C-SN1206-D080-A27-Z08-H	●	80	8	27	52	6							2510-M12x35
AFM45CL-SN1206-D080-A27-Z08-H	●	80	8	27	52	6							
AFM45C-SN1206-D100-A32-Z08-H	●	100	8	32	52	6							
AFM45C-SN1206-D100-A32-Z10-H	●	100	10	32	52	6							2514-M16x35
AFM45CL-SN1206-D100-A32-Z10-H	●	100	10	32	52	6							
AFM45C-SN1206-D125-B40-Z11	●	125	11	40	65	6							
AFM45CL-SN1206-D125-B40-Z11	●	125	11	40	65	6							
AFM45C-SN1206-D160-C40-Z12	●	160	12	40	65	6							-
AFM45C-SN1206-D200-C60-Z14	●	200	14	60	65	6							
AFM45CL-SN1206-D200-C60-Z14	●	200	14	60	65	6							

KRLY-PLBT-BHLR Ucuna Uygunudur. / Compatible with KRLY-PLBT-BHLR Insert. Kompatibel mit KRLY-PLBT-BHLR Wendepfatten.

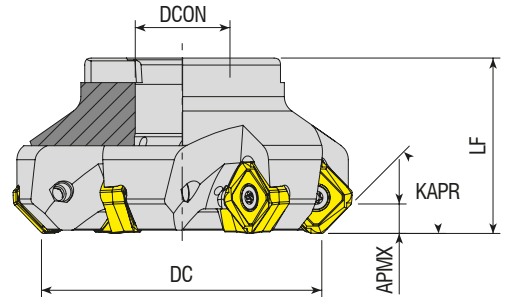

Takım Kodu Ordering Code Bestell-Bezeichnung	Stok Stock Lager	Takım Ölçüleri (mm) Dimension (mm) Abmessung (mm)					Kesici Uç Insert Wendeschneidplatte	Yedek Parçaları / Spare Parts / Ersatzteile					
		DC	ZEFP	DCON	LF	APMX		Sıkma Vidası Screw Schraube	Tork Anahtar Torx Key Torx-Schlüssel	Montaj Vidası Mounting Screw Befestigungsschraube			
AFM45-SA1706-D080-A27-Z06-H	●	80	6	27	50	8.4	SAKU 1706..						
AFM45-SA1706-D100-A32-Z07-H	●	100	7	32	50	8.4					1020-M5x14	80-T20	2510-M12x35
AFM45-SA1706-D125-B40-Z09	●	125	9	40	63	8.4					-	-	2514-M16x35

R: Sağ / Right / Rechts L: Sol/Left/Links

● Stokta / In Stock / Auf Lager ○ Stokta Yok / Non Stock Item / Kein Lagerartikel, Lieferzeit auf Anfrage

CRTZT Ucuna Uygunudur. / Compatible with CRTZT Insert. Kompatibel mit CRTZT Wendepfatten.

Sipariş Örneği/Ordering Example/Bestellbeispiel

1 ad./pcs./stück AFM45C-SN1206-D050-A22-Z04-H

Kesme Hesabı : S 331 / Cutting Calculation : P 331 / Schnittberechnung : 331

Montaj Ölçüleri : S 328 / Mounting Reference : P 328 / Montagehinweis : 328

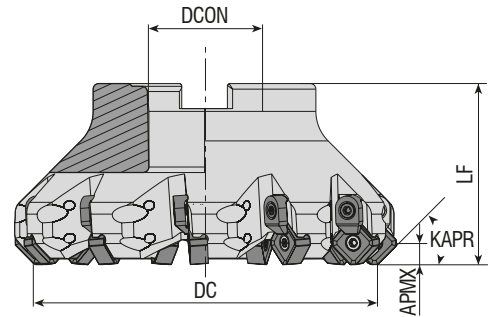

Takım Kodu Ordering Code Bestell-Bezeichnung	Stok Stock Lager	Takım Ölçüleri (mm) Dimension (mm) Abmessung (mm)					Kesici Uç Insert Wendeschneidplatte	Yedek Parçaları / Spare Parts / Ersatzteile					
		DC	ZEFP	DCON	LF	APMX		Sıkma Vidası Screw Schraube	Baskı Parçası Wedge Clamp Spannpratze	Baskı Vidası Clamp Screw Klemmschraube	Tork Anahtar Torx Key Torx-Schlüssel	Montaj Vidası Mounting Screw Befestigungsschraube	
AFM45C-SN12Z-D050-A22-Z05-H	●	50	5	22	42	6	SNEG 1205..	4015-M4x11	ACK-05	4015-M4x11	80-T15	2407-M10x30	
AFM45C-SN12Z-D063-A22-Z06-H	●	63	6	22	42	6							2510-M12x35
AFM45C-SN12Z-D080-A27-Z07-H	●	80	7	27	52	6							2514-M16x35
AFM45C-SN12Z-D100-A32-Z09-H	●	100	9	32	52	6							-
AFM45C-SN12Z-D125-B40-Z11	●	125	11	40	65	6							-
AFM45C-SN12Z-D160-C40-Z12	●	160	12	60	65	6							-
AFM45C-SN12Z-D200-C60-Z14	●	200	14	60	65	6							-

ZCC Ucuna Uygundur. / Compatiple with ZCC Insert. Kompatibel mit ZCC Wendeplatten.

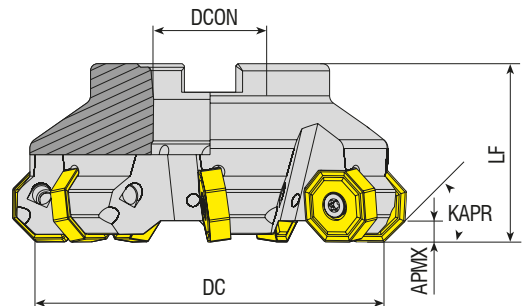

Takım Kodu Ordering Code Bestell-Bezeichnung	Stok Stock Lager	Takım Ölçüleri (mm) Dimension (mm) Abmessung (mm)					Kesici Uç Insert Wendeschneidplatte	Yedek Parçaları / Spare Parts / Ersatzteile			
		DC	ZEFP	DCON	LF	APMX		Sıkma Vidası Screw Schraube	Tork Anahtar Torx Key Torx-Schlüssel	Montaj Vidası Mounting Screw Befestigungsschraube	
AFM45-ON0806-D063-A22-Z05-H	●	63	5	22	40	5.5	ON.. 0806..	1020-M5x14	80-T20	2508-M10x30	
AFM45-ON0806-D063-A22-Z06-H	●	63	6	22	40	5.5					2510-M12x35
AFM45-ON0806-D080-A27-Z06-H	●	80	6	27	50	5.5					2514-M16x35
AFM45-ON0806-D080-A27-Z08-H	●	80	8	27	50	5.5					-
AFM45-ON0806-D100-A32-Z07-H	●	100	7	32	50	5.5					-
AFM45-ON0806-D100-A32-Z10-H	●	100	10	32	50	5.5					-
AFM45-ON0806-D125-B40-Z08	●	125	8	40	63	5.5					-
AFM45-ON0806-D160-C40-Z10	●	160	10	40	63	5.5					-
AFM45-ON0806-D200-C60-Z12	●	200	12	60	63	5.5					-
AFM45-ON0806-D315-D60-Z16	●	315	16	60	63	5.5					-

R: Sağ / Right / Rechts L: Sol/Left/Links

● Stokta / In Stock / Auf Lager ○ Stokta Yok / Non Stock Item / Kein Lagerartikel, Lieferzeit auf Anfrage
ISO Ucuna Uygundur. / Compatiple with ISO Insert. Kompatibel mit ISO Wendeplatten.

Sipariş Örneği/Ordering Example/Bestellbeispiel
1 ad./pcs./stück AFM45C-SN12Z-D050-A22-Z05-H
Kesme Hesabı : S 331 / Cutting Calculation : P 331 / Schnittberechnung : 331
Montaj Ölçüleri : S 328 / Mounting Reference : P 328 / Montagehinweis : 328



KAPR=45°

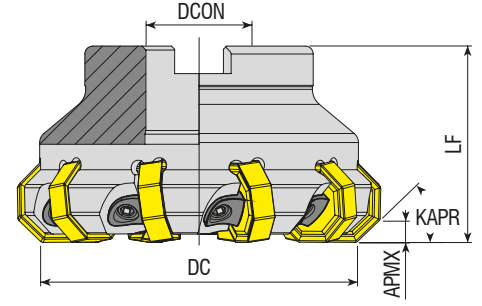

Takım Kodu Ordering Code Bestell-Bezeichnung	Stok Stock Lager	Takım Ölçüleri (mm) Dimension (mm) Abmessung (mm)					Kesici Uç Insert Wendeschneidplatte	Yedek Parçaları / Spare Parts / Ersatzteile				
		DC	ZEFP	DCON	LF	APMX		Baskı Parçası Wedge Clamp Spannpratze	Baskı Vidası Clamp Screw Klemmschraube	Anahtar Allen Key Innensechskantschlüssel	Montaj Vidası Mounting Screw Befestigungsschraube	
AFM45C-ON0806-D080-A27-Z10	●	80	10	27	50	5.5	ON.. 0806..	ACK-26	AKV-26-M6x0.75x20	AAL-03-3	2510-M12x35 2514-M16x35	
AFM45C-ON0806-D100-A32-Z14	●	100	14	32	50	5.5						
AFM45C-ON0806-D125-B40-Z18	●	125	18	40	63	5.5						
AFM45C-ON0806-D160-C40-Z22	●	160	22	40	63	5.5						

ISO Ucuna Uygundur. / Compatible with ISO Insert. Kompatibel mit ISO Wendeplatten.

KAPR=45°

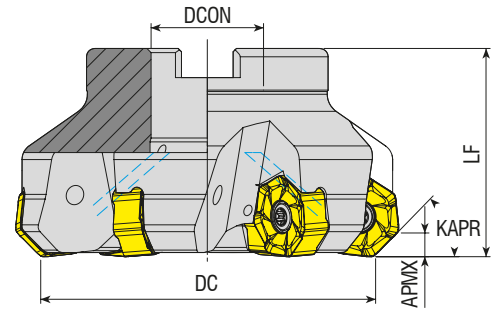

Takım Kodu Ordering Code Bestell-Bezeichnung	Stok Stock Lager	Takım Ölçüleri (mm) Dimension (mm) Abmessung (mm)					Kesici Uç Insert Wendeschneidplatte	Yedek Parçaları / Spare Parts / Ersatzteile				
		DC	ZEFP	DCON	LF	APMX		Sıkma Vidası Screw Schraube	Baskı Parçası Wedge Clamp Spannpratze	Baskı Vidası Clamp Screw Klemmschraube	Tork Anahtar Torx Key Torx-Schlüssel	Montaj Vidası Mounting Screw Befestigungsschraube
AFM45-XN0906-D063-A22-Z06-H	●	63	6	22	50	5	XNMU 0906..	1120-M5x13	-	-	80-T20	2407-M10x30 2510-M12x35 2514-M16x35
AFM45-XN0906-D080-A27-Z06-H	●	80	6	27	50	5						
AFM45-XN0906-D100-A32-Z07-H	●	100	7	32	55	5						
AFM45-XN0906-D125-B40-Z08	●	125	8	40	63	5						

R: Sağ / Right / Rechts L: Sol/Left/Links

● Stokta / In Stock / Auf Lager ○ Stokta Yok / Non Stock Item / Kein Lagerartikel, Lieferzeit auf Anfrage

TGTC Ucuna Uygundur. / Compatible with TGTC Insert. Kompatibel mit TGTC Wendeplatten.

Sipariş Örneği/Ordering Example/Bestellbeispiel

1 ad./pcs./stück AFM45C-ON0806-D080-A27-Z10

Kesme Hesabı : S 331 / Cutting Calculation : P 331 / Schnittberechnung : 331

Montaj Ölçüleri : S 328 / Mounting Reference : P 328 / Montagehinweis : 328

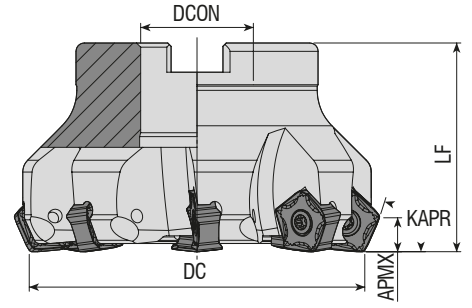

Takım Kodu Ordering Code Bestell-Bezeichnung	Stok Stock Lager	Takım Ölçüleri (mm) Dimension (mm) Abmessung (mm)					Kesici Uç Insert Wendeschneidplatte	Yedek Parçaları / Spare Parts / Ersatzteile			
		DC	ZEFP	DCON	LF	APMX		Sıkma Vidası Screw Schraube	Tork Anahtar Torx Key Torx-Schlüssel	Montaj Vidası Mounting Screw Befestigungsschraube	
AFM66-PN0905-D050-A22-Z05	●	50	5	22	40	8	PNMU 0905..	4015-M4x11	80-T15	2508-M10x30	
AFM66-PN0905-D063-A22-Z06	●	63	6	22	40	8					
AFM66-PN0905-D080-A27-Z08	●	80	8	27	50	8					
AFM66-PN0905-D100-A32-Z10	●	100	10	32	50	8					
AFM66-PN0905-D125-B40-Z12	●	125	12	40	63	8					

KYCR Ucuna Uygun. / Compatible with KYCR Insert. Kompatibel mit KYCR Wendeplatten.

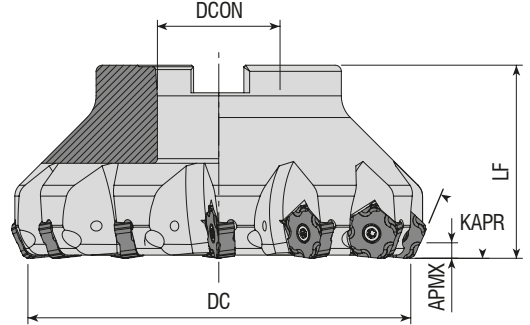

Takım Kodu Ordering Code Bestell-Bezeichnung	Stok Stock Lager	Takım Ölçüleri (mm) Dimension (mm) Abmessung (mm)					Kesici Uç Insert Wendeschneidplatte	Yedek Parçaları / Spare Parts / Ersatzteile			
		DC	ZEFP	DCON	LF	APMX		Sıkma Vidası Screw Schraube	Tork Anahtar Torx Key Torx-Schlüssel	Montaj Vidası Mounting Screw Befestigungsschraube	
AFM67-PN1105-D050-A22-Z05	●	50	5	22	50	5	PNEG 1105..	4015-M4x11	80-T15	2508-M10x30	
AFM67-PN1105-D063-A22-Z06	●	63	6	22	50	5					
AFM67-PN1105-D080-A27-Z08	●	80	8	27	50	5					
AFM67-PN1105-D100-B32-Z10	●	100	10	32	50	5					
AFM67-PN1105-D125-B40-Z12	●	125	12	40	63	5					
AFM67-PN1105-D160-C40-Z14	●	160	14	40	63	5					

R: Sağ / Right / Rechts L: Sol/Left/Links

● Stokta / In Stock / Auf Lager ○ Stokta Yok / Non Stock Item / Kein Lagerartikel, Lieferzeit auf Anfrage
ZCC Ucuna Uygun. / Compatible with ZCC Insert. Kompatibel mit ZCC Wendeplatten.

Sipariş Örneği/Ordering Example/Bestellbeispiel

1 ad./pcs./stück AFM66-PN0905-D050-A22-Z05

Kesme Hesabı : S 331 / Cutting Calculation : P 331 / Schnittberechnung : 331

Montaj Ölçüleri : S 328 / Mounting Reference : P 328 / Montagehinweis : 328

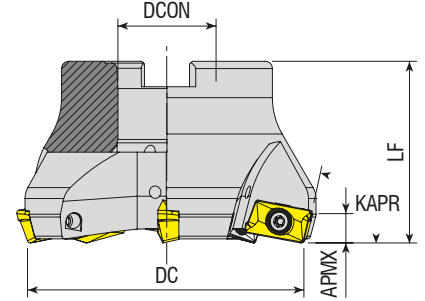

Takım Kodu Ordering Code Bestell-Bezeichnung	Stok Stock Lager	Takım Ölçüleri (mm) Dimension (mm) Abmessung (mm)					Kesici Uç Insert Wendeschneidplatte	Yedek Parçaları / Spare Parts / Ersatzteile		
		DC	ZEFP	DCON	LF	APMX		Sıkma Vidası Screw Schraube	Tork Anahtar Torx Key Torx-Schlüssel	Montaj Vidası Mounting Screw Befestigungsschraube
AFM75-AP16-D063-A22-Z04-H	●	63	4	22	40	6	AP. 1604..		80-T15	2508-M10x30
AFM75-AP16-D080-A27-Z05-H	●	80	5	27	50	6				2510-M12x35
AFM75-AP16-D100-A32-Z06-H	●	100	6	32	50	6				2514-M16x35
AFM75-AP16-D125-B40-Z07	●	125	7	40	63	6				-

ISO Ucuna Uygun. / Compatible with ISO Insert. Kompatibel mit ISO Wendeplatten.

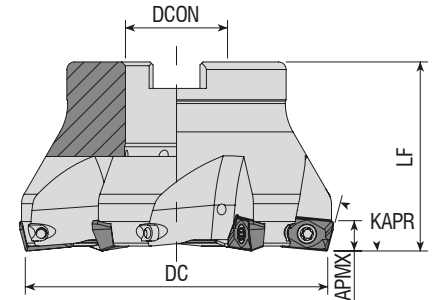

Takım Kodu Ordering Code Bestell-Bezeichnung	Stok Stock Lager	Takım Ölçüleri (mm) Dimension (mm) Abmessung (mm)					Kesici Uç Insert Wendeschneidplatte	Yedek Parçaları / Spare Parts / Ersatzteile			
		DC	ZEFP	DCON	LF	APMX		Sıkma Vidası Screw Schraube	Tork Anahtar Torx Key Torx-Schlüssel	Montaj Vidası Mounting Screw Befestigungsschraube	
AFM75-X012-D050-A22-Z04-H	●	50	4	22	40	-	XOMX 1204..		80-T10	2508-M10x30	
AFM75-X012-D063-A22-Z05-H	●	63	5	22	40	-				3010-M3.5x9	2510-M12x35
AFM75-X012-D080-A27-Z06-H	●	80	6	27	50	-					

R: Sağ / Right / Rechts L: Sol/Left/Links

● Stokta / In Stock / Auf Lager ○ Stokta Yok / Non Stock Item / Kein Lagerartikel, Lieferzeit auf Anfrage
SC Ucuna Uygun. / Compatible with SC Insert. Kompatibel mit SC Wendeplatten.

Sipariş Örneği/Ordering Example/Bestellbeispiel

1 ad./pcs./stück AFM75-AP16-D063-A22-Z04-H

Kesme Hesabı : S 331 / Cutting Calculation : P 331 / Schnittberechnung : 331

Montaj Ölçüleri : S 328 / Mounting Reference : P 328 / Montagehinweis : 328

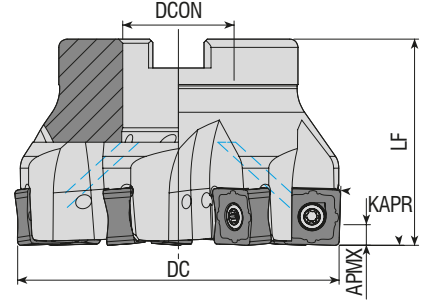

Takım Kodu Ordering Code Bestell-Bezeichnung	Stok Stock Lager	Takım Ölçüleri (mm) Dimension (mm) Abmessung (mm)					Kesici Uç Insert Wendeschneidplatte	Yedek Parçaları / Spare Parts / Ersatzteile		
		DC	ZEFP	DCON	LF	APMX		Sıkma Vidası Screw Schraube	Tork Anahtar Torx Key Torx-Schlüssel	Montaj Vidası Mounting Screw Befestigungsschraube
AFM88-SN1305-D050-A22-Z04	●	50	4	22	40	5	SNMU 1305..	4015-M4x11	80-T15	2508-M10x30
AFM88-SN1305-D050-A22-Z05	●	50	5	22	40	5				
AFM88-SN1305-D063-A22-Z05	●	63	5	22	40	5				
AFM88-SN1305-D063-A22-Z07	●	63	7	22	40	5				
AFM88-SN1305-D080-A27-Z06	●	80	6	27	50	5				
AFM88-SN1305-D080-A27-Z09	●	80	9	27	50	5				
AFM88-SN1305-D100-A32-Z07	●	100	7	32	50	5				
AFM88-SN1305-D100-A32-Z11	●	100	11	32	50	5				
AFM88-SN1305-D125-B40-Z13	●	125	13	40	63	5				-

KYCR Ucuna Uygundur. / Compatible with KYCR Insert. Kompatibel mit KYCR Wendeplatten.

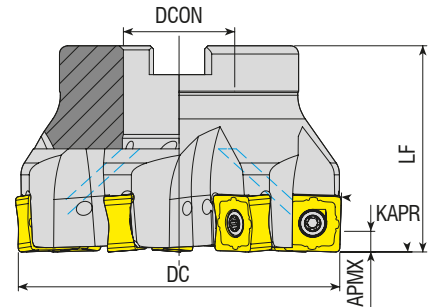

Takım Kodu Ordering Code Bestell-Bezeichnung	Stok Stock Lager	Takım Ölçüleri (mm) Dimension (mm) Abmessung (mm)					Kesici Uç Insert Wendeschneidplatte	Yedek Parçaları / Spare Parts / Ersatzteile		
		DC	ZEFP	DCON	LF	APMX		Sıkma Vidası Screw Schraube	Tork Anahtar Torx Key Torx-Schlüssel	Montaj Vidası Mounting Screw Befestigungsschraube
AFM88-SN1306-D050-A22-Z05-H	●	50	5	22	40	5	SNGX 1306..	1115-M4x10	80-T15	2508-M10x30
AFM88-SN1306-D063-A22-Z06-H	●	63	6	22	40	5				
AFM88-SN1306-D080-A27-Z07-H	●	80	7	27	50	5				2510-M12x35

R: Sağ / Right / Rechts L: Sol/Left/Links

● Stokta / In Stock / Auf Lager ○ Stokta Yok / Non Stock Item / Kein Lagerartikel, Lieferzeit auf Anfrage
TGTC Ucuna Uygundur. / Compatible with TGTC Insert. Kompatibel mit TGTC Wendeplatten.

Sipariş Örneği/Ordering Example/Bestellbeispiel
1 ad./pcs./stück AFM88-SN1305-D050-A22-Z04
Kesme Hesabı : S 331 / Cutting Calculation : P 331 / Schnittberechnung : 331
Montaj Ölçüleri : S 328 / Mounting Reference : P 328 / Montagehinweis : 328

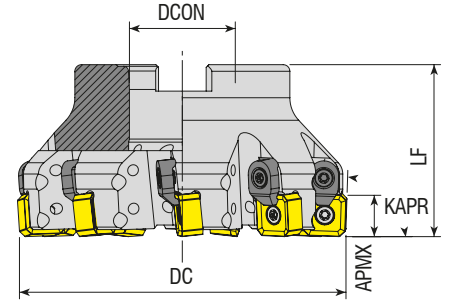
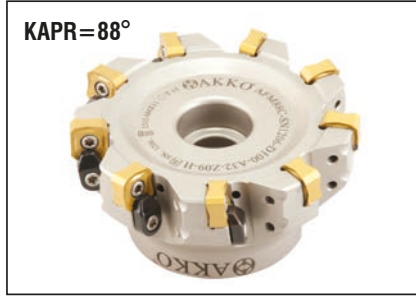

Takım Kodu Ordering Code Bestell-Bezeichnung	Stok Stock Lager	Takım Ölçüleri (mm) Dimension (mm) Abmessung (mm)					Kesici Uç Insert Wendeschneidplatte	Yedek Parçaları / Spare Parts / Ersatzteile				
		DC	ZEFP	DCON	LF	APMX		Sıkma Vidası Screw Schraube	Baskı Parçası Wedge Clamp Spannpratze	Baskı Vidası Clamp Screw Klemmschraube	Tork Anahtar Torx Key Torx-Schlüssel	Montaj Vidası Mounting Screw Befestigungsschraube
AFM88C-SN1206-D063-A22-Z06-H	●	63	6	22	40	11.5	SN.. 1206..	4615-M4x11	ACK-05	4015-M4x11	80-T15	2508-M10x30
AFM88C-SN1206-D080-A27-Z07-H	●	80	7	27	50	11.5						2510-M12x35
AFM88C-SN1206-D100-A32-Z09-H	●	100	9	32	52	11.5						2514-M16x35

ISO Ucuna Uygundur. / Compatible with ISO Insert. Kompatibel mit ISO Wendepfetten.

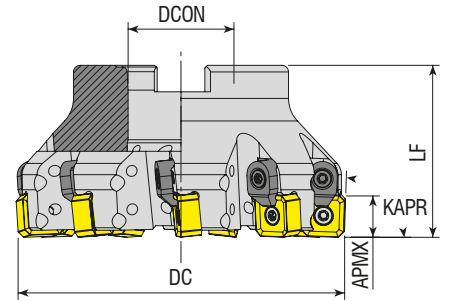

Takım Kodu Ordering Code Bestell-Bezeichnung	Stok Stock Lager	Takım Ölçüleri (mm) Dimension (mm) Abmessung (mm)					Kesici Uç Insert Wendeschneidplatte	Yedek Parçaları / Spare Parts / Ersatzteile				
		DC	ZEFP	DCON	LF	APMX		Sıkma Vidası Screw Schraube	Baskı Parçası Wedge Clamp Spannpratze	Baskı Vidası Clamp Screw Klemmschraube	Tork Anahtar Torx Key Torx-Schlüssel	Montaj Vidası Mounting Screw Befestigungsschraube
AFM88C-SN12..-D063-A22-Z06-H	●	63	6	22	40	11.5	SN.. 12..	1015-M4x11	ACK-05	4015-M4x11	80-T15	2508-M10x30
AFM88C-SN12..-D080-A27-Z07-H	●	80	7	27	50	11.5						2510-M12x35
AFM88C-SN12..-D100-A32-Z09-H	●	100	9	32	52	11.5						2514-M16x35

R: Sağ / Right / Rechts L: Sol/Left/Links

● Stokta / In Stock / Auf Lager ○ Stokta Yok / Non Stock Item / Kein Lagerartikel, Lieferzeit auf Anfrage
ISO Ucuna Uygundur. / Compatible with ISO Insert. Kompatibel mit ISO Wendepfetten.

Sipariş Örneği/Ordering Example/Bestellbeispiel

1 ad./pcs./stück AFM88C-SN1206-D063-A22-Z06-H

Kesme Hesabı : S 331 / Cutting Calculation : P 331 / Schnittberechnung : 331

Montaj Ölçüleri : S 328 / Mounting Reference : P 328 / Montagehinweis : 328

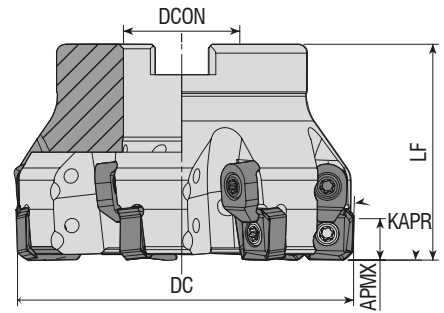

Takım Kodu Ordering Code Bestell-Bezeichnung	Stok Stock Lager	Takım Ölçüleri (mm) Dimension (mm) Abmessung (mm)					Kesici Uç Insert Wendeschneidplatte	Yedek Parçaları / Spare Parts / Ersatzteile				
		DC	ZEFP	DCON	LF	APMX		Sıkma Vidası Screw Schraube	Baskı Parçası Wedge Clamp Spannpratze	Baskı Vidası Clamp Screw Klemmschraube	Tork Anahtar Torx Key Torx-Schlüssel	Montaj Vidası Mounting Screw Befestigungsschraube
AFM88C-SN12Z-D063-A22-Z06-H	●	63	6	22	40	11.5	SNEG 1205..	4015-M4x11	ACK-05	4015-M4X11	80-T15	2508-M10x30 2510-M12x35
AFM88C-SN12Z-D080-A27-Z07-H	●	80	7	27	50	11.5						

ZCC Ucuna Uygunudur. / Compatible with ZCC Insert. Kompatibel mit ZCC Wendeplatten.

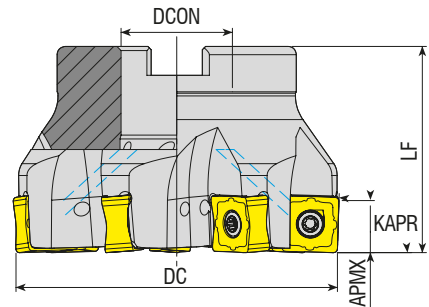

Takım Kodu Ordering Code Bestell-Bezeichnung	Stok Stock Lager	Takım Ölçüleri (mm) Dimension (mm) Abmessung (mm)					Kesici Uç Insert Wendeschneidplatte	Yedek Parçaları / Spare Parts / Ersatzteile				
		DC	ZEFP	DCON	LF	APMX		Sıkma Vidası Screw Schraube	Baskı Parçası Wedge Clamp Spannpratze	Baskı Vidası Clamp Screw Klemmschraube	Tork Anahtar Torx Key Torx-Schlüssel	Montaj Vidası Mounting Screw Befestigungsschraube
AFM89-SN1305I-D040-A16-Z04-H	●	40	4	16	40	10	SNMU 1305..	1015 M4x11	-	-	80-T15	2306-M8x37 2508-M10x30 2510-M12x35 2514-M16x35
AFM89-SN1305I-D050-A22-Z05-H	●	50	5	22	40	10						
AFM89-SN1305I-D063-A22-Z06-H	●	63	6	22	40	10	SNMU 1305.. OXMT 0507..	1015 M4x11	-	-	80-T15	2508-M10x30 2510-M12x35 2514-M16x35
AFM89-SN1305I-D063-A22-Z07-H	●	63	7	22	40	10						
AFM89-SN1305I-D080-A27-Z08-H	●	80	8	27	50	10						
AFM89-SN1305I-D100-A32-Z10-H	●	100	10	32	50	10						

R: Sağ / Right / Rechts L: Sol/Left/Links
● Stokta / In Stock / Auf Lager ○ Stokta Yok / Non Stock Item / Kein Lagerartikel, Lieferzeit auf Anfrage
ISCR Ucuna Uygunudur. / Compatible with ISCR Insert. Kompatibel mit ISCR Wendeplatten.

Sipariş Örneği/Ordering Example/Bestellbeispiel
1 ad./pcs./stück AFM88C-SN12Z-D063-A22-Z06-H
Kesme Hesabı : S 331 / Cutting Calculation : P 331 / Schnittberechnung : 331
Montaj Ölçüleri : S 328 / Mounting Reference : P 328 / Montagehinweis : 328

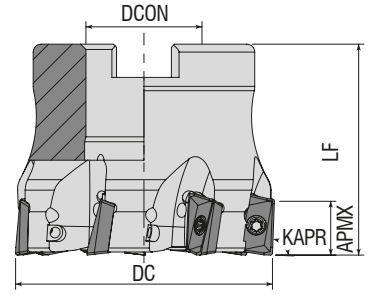

Takım Kodu Ordering Code Bestell-Bezeichnung	Stok Stock Lager	Takım Ölçüleri (mm) Dimension (mm) Abmessung (mm)					Kesici Uç Insert Wendeschneidplatte	Yedek Parçaları / Spare Parts / Ersatzteile		
		DC	ZEFP	DCON	LF	APMX		Sıkma Vidası Screw Schraube	Tork Anahtar Torx Key Torx-Schlüssel	Montaj Vidası Mounting Screw Befestigungsschraube
AFM90-AD10T3-D040-A16-Z06-H	●	40	6	16	40	10	ADMT 10T3..	3008-M2.5x6	80-T08	2506-M8x30
AFM90-AD10T3-D050-A22-Z07-H	●	50	7	22	40	10				2508-M10x30

WLTR Ucuna Uygunur. / Compatiple with WLTR Insert. Kompatibel mit WLTR Wendeplatten.

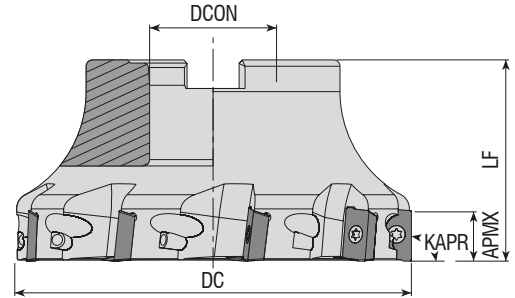

Takım Kodu Ordering Code Bestell-Bezeichnung	Stok Stock Lager	Takım Ölçüleri (mm) Dimension (mm) Abmessung (mm)					Kesici Uç Insert Wendeschneidplatte	Yedek Parçaları / Spare Parts / Ersatzteile		
		DC	ZEFP	DCON	LF	APMX		Sıkma Vidası Screw Schraube	Tork Anahtar Torx Key Torx-Schlüssel	Montaj Vidası Mounting Screw Befestigungsschraube
AFM90-AD1505-D040-A16-Z04-H	●	40	4	16	40	15	AD.. 1505..	4015-M4x11	80-T15	2506-M8x30
AFM90-AD1505-D050-A22-Z05-H	●	50	5	22	40	15				2508-M10x30
AFM90-AD1505-D063-A22-Z06-H	●	63	6	22	40	15				2510-M12x35
AFM90-AD1505-D080-A27-Z07-H	●	80	7	27	50	15				2514-M16x35
AFM90-AD1505-D100-A32-Z08-H	●	100	8	32	50	15				-
AFM90-AD1505-D125-B40-Z09	●	125	9	40	63	15				-

R: Sağ / Right / Rechts L: Sol/Left/Links

● Stokta / In Stock / Auf Lager ○ Stokta Yok / Non Stock Item / Kein Lagerartikel, Lieferzeit auf Anfrage
ISCR Ucuna Uygunur. / Compatiple with ISCR Insert. Kompatibel mit ISCR Wendeplatten.

Sipariş Örneği/Ordering Example/Bestellbeispiel

1 ad./pcs./stück AFM90-AD10T3-D040-A16-Z06-H

Kesme Hesabı : S 331 / Cutting Calculation : P 331 / Schnittberechnung : 331

Montaj Ölçüleri : S 328 / Mounting Reference : P 328 / Montagehinweis : 328

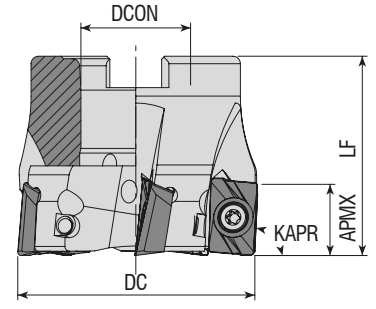

Takım Kodu Ordering Code Bestell-Bezeichnung	Stok Stock Lager	Takım Ölçüleri (mm) Dimension (mm) Abmessung (mm)					Kesici Uç Insert Wendeschneidplatte	Yedek Parçaları / Spare Parts / Ersatzteile		
		DC	ZEFP	DCON	LF	APMX		Sıkma Vidası Screw Schraube	Tork Anahtar Torx Key Torx-Schlüssel	Montaj Vidası Mounting Screw Befestigungsschraube
AFM90-AD1505D-D050-A22-Z05-H	●	50	5	22	40	14.3	ADKT 150508	4015-M4x11	80-T15	2508-M10x30
AFM90-AD1505D-D063-A27-Z06-H	●	63	6	27	50	14.3				2510-M12x35
AFM90-AD1505D-D080-A27-Z08-H	●	80	8	27	50	14.3				2514-M16x35
AFM90-AD1505D-D100-A32-Z08-H	●	100	8	32	50	14.3				-
AFM90-AD1505D-D125-B40-Z09	●	125	9	40	63	14.3				-

DJT Ucuna Uygunur. / Compatiple with DJT Insert. Kompatibel mit DJT Wendepplatten.

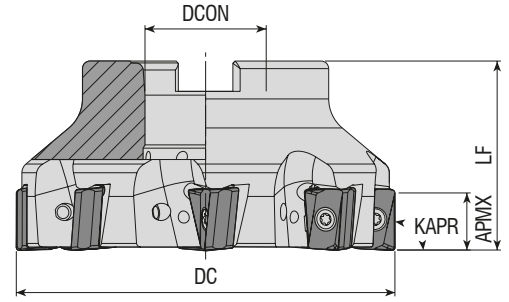

Takım Kodu Ordering Code Bestell-Bezeichnung	Stok Stock Lager	Takım Ölçüleri (mm) Dimension (mm) Abmessung (mm)					Kesici Uç Insert Wendeschneidplatte	Yedek Parçaları / Spare Parts / Ersatzteile					
		DC	ZEFP	DCON	LF	APMX		Sıkma Vidası Screw Schraube	Tork Anahtar Torx Key Torx-Schlüssel	Montaj Vidası Mounting Screw Befestigungsschraube			
AFM90-AN11-D040-A16-Z04-H	●	40	4	16	40	11	ANGX 1105..	4010-M3x8	80-T10	2506-M8x30			
AFM90-AN1506-D050-A22-Z04-H	●	50	4	22	40	14.5				2508-M10x30			
AFM90-AN1506-D063-A22-Z05-H	●	63	5	22	40	14.5				ANGX 1506..	4015-M4x12	80-T15	2510-M12x35
AFM90-AN1506-D080-A27-Z06-H	●	80	6	27	50	14.5							2514-M16x35
AFM90-AN1506-D100-A32-Z08-H	●	100	8	32	50	14.5							-
AFM90-AN1506-D125-B40-Z09	●	125	9	40	63	14.5							-
AFM90-AN1506-D160-C40-Z10	●	160	10	40	63	14.5	-						

R: Sağ / Right / Rechts L: Sol/Left/Links

● Stokta / In Stock / Auf Lager ○ Stokta Yok / Non Stock Item / Kein Lagerartikel, Lieferzeit auf Anfrage
ZCC Ucuna Uygunur. / Compatiple with ZCC Insert. Kompatibel mit ZCC Wendepplatten.

Sipariş Örneği/Ordering Example/Bestellbeispiel

1 ad./pcs./stück AFM90-AD1505D-D050-A22-Z05-H

Kesme Hesabı : S 331 / Cutting Calculation : P 331 / Schnittberechnung : 331

Montaj Ölçüleri : S 328 / Mounting Reference : P 328 / Montagehinweis : 328

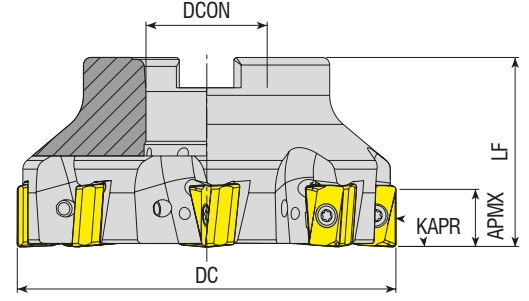

Takım Kodu Ordering Code Bestell-Bezeichnung	Stok Stock Lager	Takım Ölçüleri (mm) Dimension (mm) Abmessung (mm)					Kesici Uç Insert Wendeschneidplatte	Yedek Parçaları / Spare Parts / Ersatzteile		
		DC	ZEFP	DCON	LF	APMX		Sıkma Vidası Screw Schraube	Tork Anahtar Torx Key Torx-Schlüssel	Montaj Vidası Mounting Screw Befestigungsschraube
AFM90-AN1607-D050-A22-Z04-H	●	50	4	22	40	15	AN.X 1607..	4015-M4x11	80-T15	2508-M10x30 2510-M12x35 2514-M16x35 -
AFM90-AN1607-D063-A22-Z06-H	●	63	6	22	40	15				
AFM90-AN1607-D080-A27-Z07-H	●	80	7	27	50	15				
AFM90-AN1607-D100-A32-Z08-H	●	100	8	32	50	15				
AFM90-AN1607-D125-B40-Z10	●	125	9	40	63	15				

TGTC Ucuna Uygundur. / Compatible with TGTC Insert. Kompatibel mit TGTC Wendeplatten.

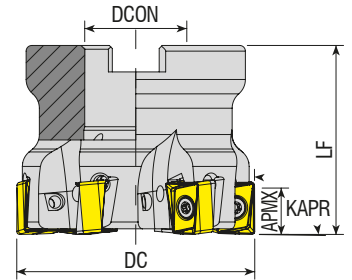

Takım Kodu Ordering Code Bestell-Bezeichnung	Stok Stock Lager	Takım Ölçüleri (mm) Dimension (mm) Abmessung (mm)					Kesici Uç Insert Wendeschneidplatte	Yedek Parçaları / Spare Parts / Ersatzteile		
		DC	ZEFP	DCON	LF	APMX		Sıkma Vidası Screw Schraube	Tork Anahtar Torx Key Torx-Schlüssel	Montaj Vidası Mounting Screw Befestigungsschraube
AFM90-AN12-D040-A16-Z04-H	●	40	4	16	40	12	ANKX 1205..	4015-M4x12	80-T15	2406-M8x30 2508-M10x30 2510-M12x35
AFM90-AN12-D050-A22-Z05-H	●	50	5	22	40	12				
AFM90-AN12-D063-A27-Z06-H	●	63	6	27	50	12				

R: Sağ / Right / Rechts L: Sol/Left/Links

● Stokta / In Stock / Auf Lager ○ Stokta Yok / Non Stock Item / Kein Lagerartikel, Lieferzeit auf Anfrage
ISCR Ucuna Uygundur. / Compatible with ISCR Insert. Kompatibel mit ISCR Wendeplatten.

Sipariş Örneği/Ordering Example/Bestellbeispiel

1 ad./pcs./stück AFM90-AN1607-D050-A22-Z04-H

Kesme Hesabı : S 331 / Cutting Calculation : P 331 / Schnittberechnung : 331

Montaj Ölçüleri : S 328 / Mounting Reference : P 328 / Montagehinweis : 328

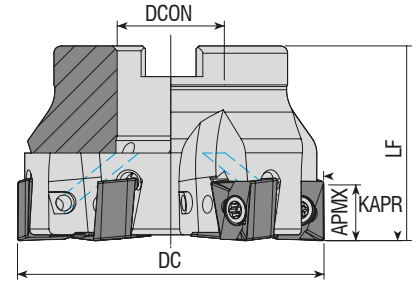

Takım Kodu Ordering Code Bestell-Bezeichnung	Stok Stock Lager	Takım Ölçüleri (mm) Dimension (mm) Abmessung (mm)					Kesici Uç Insert Wendeschneidplatte	Yedek Parçaları / Spare Parts / Ersatzteile		
		DC	ZEFP	DCON	LF	APMX		Sıkma Vidası Screw Schraube	Tork Anahtar Torx Key Torx-Schlüssel	Montaj Vidası Mounting Screw Befestigungsschraube
AFM90-AN1207-D040-A16-Z04-H	●	40	4	16	40	10	ANKX 1207..	4015-M4x11	80-T15	2506-M8x30
AFM90-AN1207-D050-A22-Z05-H	●	50	5	22	40	10				2508-M10x30
AFM90-AN1207-D063-A22-Z06-H	●	63	6	22	40	10	ANKX 1607..	4015-M4x11	80-T15	2508-M10x30
AFM90-AN1607X-D050-A22-Z04-H	●	50	4	22	40	15				2510-M12x35
AFM90-AN1607X-D063-A22-Z06-H	●	63	6	22	40	15				
AFM90-AN1607X-D080-A27-Z07-H	●	80	7	27	50	15				

XTC-GSC Ucuna Uygundur. / Compatible with XTC-GSC Insert. Kompatibel mit XTC-GSC Wendeplatten.

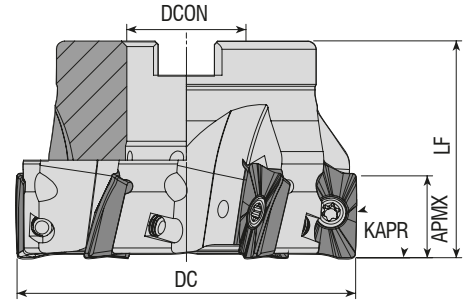

Takım Kodu Ordering Code Bestell-Bezeichnung	Stok Stock Lager	Takım Ölçüleri (mm) Dimension (mm) Abmessung (mm)					Kesici Uç Insert Wendeschneidplatte	Yedek Parçaları / Spare Parts / Ersatzteile		
		DC	ZEFP	DCON	LF	APMX		Sıkma Vidası Screw Schraube	Tork Anahtar Torx Key Torx-Schlüssel	Montaj Vidası Mounting Screw Befestigungsschraube
AFM90-A01236-D050-A22-Z05-H	●	50	5	22	40	12	AO.. 1236..	3008-M2.5x6	80-T08	2508-M10x30
AFM90-A01848-D050-A22-Z05-H	●	50	5	22	40	15	AO.. 1848..	4015-M4x11	80-T15	
AFM90-A01848-D063-A22-Z06-H	●	63	6	22	40	15				

R: Sağ / Right / Rechts L: Sol/Left/Links
● Stokta / In Stock / Auf Lager ○ Stokta Yok / Non Stock Item / Kein Lagerartikel, Lieferzeit auf Anfrage
MTSBH Ucuna Uygundur. / Compatible with MTSBH Insert. Kompatibel mit MTSBH Wendeplatten.

Sipariş Örneği/Ordering Example/Bestellbeispiel
1 ad./pcs./stück AFM90-AN1207-D040-A16-Z04-H
Kesme Hesabı : S 331 / Cutting Calculation : P 331 / Schnittberechnung : 331
Montaj Ölçüleri : S 328 / Mounting Reference : P 328 / Montagehinweis : 328

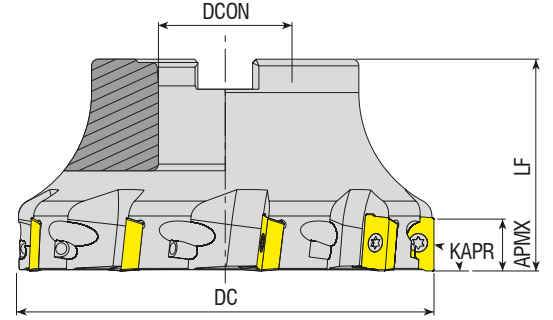

Yedek Parçaları / Spare Parts / Ersatzteile

Takım Kodu Ordering Code Bestell-Bezeichnung	Stok Stock Lager	Takım Ölçüleri (mm) Dimension (mm) Abmessung (mm)					Kesici Uç Insert Wendeschneidplatte	Yedek Parçaları / Spare Parts / Ersatzteile		
		DC	ZEFP	DCON	LF	APMX		Sıkma Vidası Screw Schraube	Tork Anahtar Torx Key Torx-Schlüssel	Montaj Vidası Mounting Screw Befestigungsschraube
AFM90-AP10-D040-A16-Z05-H	●	40	5	16	40	10	AP. 1003.. ISO UCUNA UYGUNDUR. FOR ISO INSERT. FÜR ISO-WENDEPLATTE	3008-M2.5x6	80-T08	2506-M8x30
AFM90-AP10-D050-A22-Z06-H	●	50	6	22	40	10				2508-M10x30
AFM90-AP10-D063-A22-Z07-H	●	63	7	22	40	10				2510-M12x35
AFM90-AP10-D080-A27-Z08-H	●	80	8	27	50	10	AP. 1604.. ISO UCUNA UYGUNDUR. FOR ISO INSERT. FÜR ISO-WENDEPLATTE			2514-M16x35
AFM90-AP10-D100-A32-Z09-H	●	100	9	32	50	10				2506-M8x30
AFM90-AP16-D040-A16-Z04-H	●	40	4	16	40	16				2508-M10x30
AFM90-AP16-D050-A22-Z05-H	●	50	5	22	40	16	AP. 1604.. DJT UCUNA UYGUNDUR. FOR DJT INSERT. FÜR DJT-WENDEPLATTE	4015-M4x11	80-T15	2510-M12x35
AFM90-AP16-D052-A22-Z05-H	●	52	5	22	40	16				2514-M16x35
AFM90-AP16-D063-A22-Z06-H	●	63	6	22	40	16				-
AFM90-AP16-D080-A27-Z07-H	●	80	7	27	50	16	AP. 1604.. LMN UCUNA UYGUNDUR. FOR LMN INSERT. FÜR LMN-WENDEPLATTE			2506-M8x30
AFM90-AP16-D100-A32-Z08-H	●	100	8	32	50	16				2508-M10x30
AFM90-AP16-D125-B40-Z09	●	125	9	40	63	16				2510-M12x35
AFM90-AP16-D160-C40-Z10	●	160	10	40	63	16	AP. 1604.. PLBT UCUNA UYGUNDUR. FOR PLBT INSERT. FÜR PLBT-WENDEPLATTE			2514-M16x35
AFM90-AP16-D200-C60-Z12	●	200	12	60	63	16				2506-M8x30
AFM90-AP16DJ-D050-A22-Z05-H	●	50	5	22	40	16				2508-M10x30
AFM90-AP16DJ-D063-A22-Z06-H	●	63	6	22	40	16	AP. 1604.. ACHTK UCUNA UYGUNDUR. FOR ACHTK INSERT. FÜR ACHTK-WENDEPLATTE			2510-M12x35
AFM90-AP16DJ-D080-A27-Z07-H	●	80	7	27	50	16				2514-M16x35
AFM90-AP16L-D050-A22-Z05-H	●	50	5	22	40	16				-
AFM90-AP16L-D063-A22-Z06-H	●	63	6	22	40	16	AP. 1604.. ACHTK UCUNA UYGUNDUR. FOR ACHTK INSERT. FÜR ACHTK-WENDEPLATTE			2506-M8x30
AFM90-AP16L-D080-A27-Z07-H	●	80	7	27	50	16				2508-M10x30
AFM90-AP16P-D040-A16-Z04-H	●	40	4	16	40	16				2510-M12x35
AFM90-AP16P-D050-A22-Z05-H	●	50	5	22	40	16	AP. 1604.. ACHTK UCUNA UYGUNDUR. FOR ACHTK INSERT. FÜR ACHTK-WENDEPLATTE			2514-M16x35
AFM90-AP16P-D063-A22-Z06-H	●	63	6	22	40	16				2506-M8x30
AFM90-AP16P-D080-A27-Z07-H	●	80	7	27	50	16				2508-M10x30
AFM90-AP16P-D100-A32-Z08-H	●	100	8	32	50	16	AP. 1604.. ACHTK UCUNA UYGUNDUR. FOR ACHTK INSERT. FÜR ACHTK-WENDEPLATTE			2510-M12x35
AFM90-AP16A-D050-A22-Z05-H	●	50	5	22	40	15				2514-M16x35
AFM90-AP16A-D063-A22-Z06-H	●	63	6	22	40	15				2506-M8x30
AFM90-AP16A-D080-A27-Z07-H	●	80	7	27	50	15	AP. 1604.. ACHTK UCUNA UYGUNDUR. FOR ACHTK INSERT. FÜR ACHTK-WENDEPLATTE			2508-M10x30
AFM90-AP16A-D100-A32-Z08-H	●	100	8	32	50	15				2510-M12x35
AFM90-AP16A-D125-B40-Z09	●	125	9	40	63	15				-

R: Sağ / Right / Rechts L: Sol/Left/Links

● Stokta / In Stock / Auf Lager ○ Stokta Yok / Non Stock Item / Kein Lagerartikel, Lieferzeit auf Anfrage

Sipariş Örneği/Ordering Example/Bestellbeispiel

1 ad./pcs./stück AFM90-AP10-D040-A16-Z05-H

Kesme Hesabı : S 331 / Cutting Calculation : P 331 / Schnittberechnung : 331

Montaj Ölçüleri : S 328 / Mounting Reference : P 328 / Montagehinweis : 328

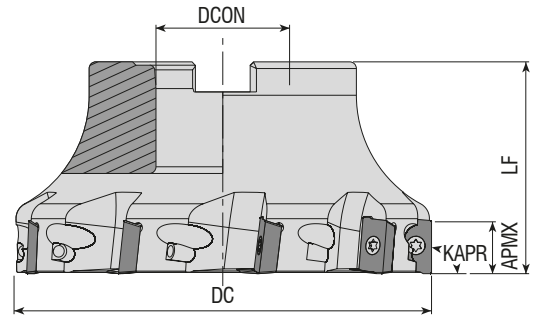
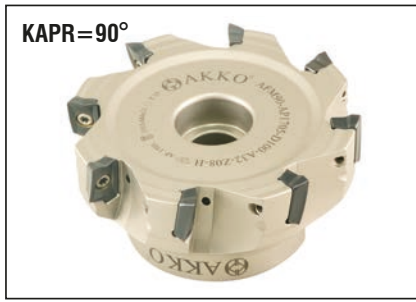

Takım Kodu Ordering Code Bestell-Bezeichnung	Stok Stock Lager	Takım Ölçüleri (mm) Dimension (mm) Abmessung (mm)					Kesici Uç Insert Wendeschneidplatte	Yedek Parçaları / Spare Parts / Ersatzteile		
		DC	ZAFP	DCON	LF	APMX		Sıkma Vidası Screw Schraube	Tork Anahtar Torx Key Torx-Schlüssel	Montaj Vidası Mounting Screw Befestigungsschraube
AFM90-AP1705-D050-A22-Z05-H	●	50	5	22	40	16	AP. 1705..	4015-M4x11	80-T15	2508-M10x30
AFM90-AP1705-D063-A22-Z06-H	●	63	6	22	40	16				2510-M12x35
AFM90-AP1705-D080-A27-Z07-H	●	80	7	27	50	16				2514-M16x35
AFM90-AP1705-D100-A32-Z08-H	●	100	8	32	50	16				

TGTC Ucuna Uygun. / Compatible with TGTC Insert. Kompatibel mit TGTC Wendeplatten.

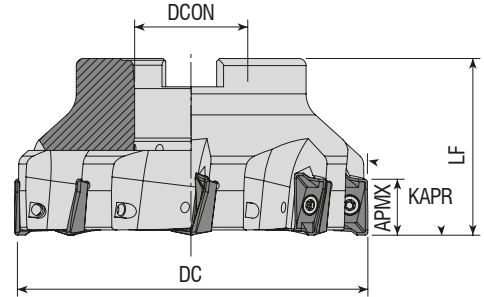

Takım Kodu Ordering Code Bestell-Bezeichnung	Stok Stock Lager	Takım Ölçüleri (mm) Dimension (mm) Abmessung (mm)					Kesici Uç Insert Wendeschneidplatte	Yedek Parçaları / Spare Parts / Ersatzteile		
		DC	ZAFP	DCON	LF	APMX		Sıkma Vidası Screw Schraube	Tork Anahtar Torx Key Torx-Schlüssel	Montaj Vidası Mounting Screw Befestigungsschraube
AFM90-AX1235-D040-A16-Z06-H	●	40	6	16	40	10	AX.T 1235..	3108-M3x6	80-T08	2506-M8x30
AFM90-AX1235-D050-A22-Z07-H	●	50	7	22	40	10				2508-M10x30
AFM90-AX1235-D063-A22-Z08-H	●	63	8	22	40	10				2510-M12x35
AFM90-AX1235-D080-A27-Z10-H	●	80	10	27	50	10				2514-M16x35
AFM90-AX1705-D040-A16-Z04-H	●	40	4	16	40	14	AX.T 1705..	4015-M4x11	80-T15	2506-M8x30
AFM90-AX1705-D050-A22-Z05-H	●	50	5	22	40	14				2508-M10x30
AFM90-AX1705-D063-A22-Z06-H	●	63	6	22	40	14				2510-M12x35
AFM90-AX1705-D080-A27-Z07-H	●	80	7	27	50	14				2514-M16x35
AFM90-AX1705-D100-A32-Z08-H	●	100	8	32	50	14				

R: Sağ / Right / Rechts L: Sol/Left/Links
● Stokta / In Stock / Auf Lager ○ Stokta Yok / Non Stock Item / Kein Lagerartikel, Lieferzeit auf Anfrage
SMTM Ucuna Uygun. / Compatible with SMTM Insert. Kompatibel mit SMTM Wendeplatten.

Sipariş Örneği/Ordering Example/Bestellbeispiel
1 ad./pcs./stück AFM90-AP1705-D050-A22-Z05-H
Kesme Hesabı : S 331 / Cutting Calculation : P 331 / Schnittberechnung : 331
Montaj Ölçüleri : S 328 / Mounting Reference : P 328 / Montagehinweis : 328

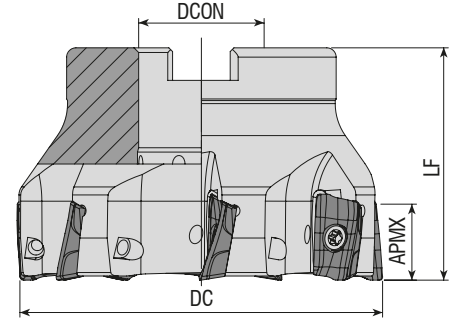

Takım Kodu Ordering Code Bestell-Bezeichnung	Stok Stock Lager	Takım Ölçüleri (mm) Dimension (mm) Abmessung (mm)					Kesici Uç Insert Wendeschneidplatte	Yedek Parçaları / Spare Parts / Ersatzteile		
		DC	ZEFP	DCON	LF	APMX		Sıkma Vidası Screw Schraube	Tork Anahtar Torx Key Torx-Schlüssel	Montaj Vidası Mounting Screw Befestigungsschraube
AFM90-BD11T3-D040-A16-Z04-H	●	40	4	16	40	10	BDMT 11T3..	3008-M2.5x6	80-T08	2506-M8x30
AFM90-BD11T3-D050-A22-Z05-H	●	50	5	22	40	10				2508-M10x30
AFM90-BD11T3-D063-A22-Z06-H	●	63	6	22	40	10				2510-M12x35
AFM90-BD1704-D050-A22-Z05-H	●	50	5	22	40	15.7	BDMT 1704..	4015-M4x11	80-T15	2508-M10x30
AFM90-BD1704-D063-A22-Z06-H	●	63	6	22	40	15.7				2510-M12x35
AFM90-BD1704-D080-A27-Z07-H	●	80	7	27	50	15.7				2510-M12x35

KYCR Ucuna Uygundur. / Compatiple with KYCR Insert. Kompatibel mit KYCR Wendeplatten.

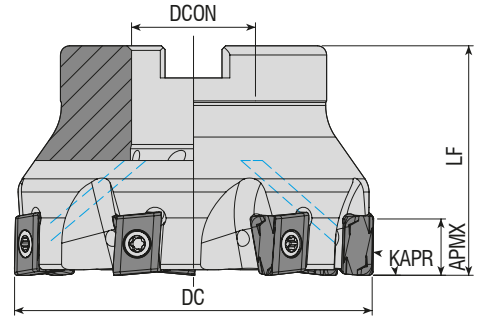

Takım Kodu Ordering Code Bestell-Bezeichnung	Stok Stock Lager	Takım Ölçüleri (mm) Dimension (mm) Abmessung (mm)					Kesici Uç Insert Wendeschneidplatte	Yedek Parçaları / Spare Parts / Ersatzteile		
		DC	ZEFP	DCON	LF	APMX		Sıkma Vidası Screw Schraube	Tork Anahtar Torx Key Torx-Schlüssel	Montaj Vidası Mounting Screw Befestigungsschraube
AFM90-LN1506X-D063-A22-Z06	●	63	6	22	40	7	LNMT 1506..	3015-M4x11	80-T15	2508-M10x30
AFM90-LN1506X-D080-A27-Z07	●	80	7	27	50	7				2510-M12x35
AFM90-LN1506X-D100-A32-Z08	●	100	8	32	50	7				2514-M16x35

R: Sağ / Right / Rechts L: Sol/Left/Links

● Stokta / In Stock / Auf Lager ○ Stokta Yok / Non Stock Item / Kein Lagerartikel, Lieferzeit auf Anfrage
XTC-GSC Ucuna Uygundur. / Compatiple with XTC-GSC Insert. Kompatibel mit XTC-GSC Wendeplatten.

Sipariş Örneği/Ordering Example/Bestellbeispiel

1 ad./pcs./stück AFM90-BD11T3-D040-A16-Z04-H

Kesme Hesabı : S 331 / Cutting Calculation : P 331 / Schnittberechnung : 331

Montaj Ölçüleri : S 328 / Mounting Reference : P 328 / Montagehinweis : 328

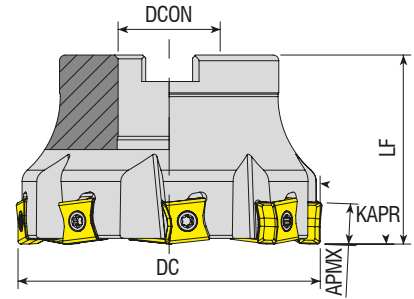

Takım Kodu Ordering Code Bestell-Bezeichnung	Stok Stock Lager	Takım Ölçüleri (mm) Dimension (mm) Abmessung (mm)					Kesici Uç Insert Wendeschneidplatte	Yedek Parçaları / Spare Parts / Ersatzteile		
		DC	ZEFP	DCON	LF	APMX		Sıkma Vidası Screw Schraube	Tork Anahtar Torx Key Torx-Schlüssel	Montaj Vidası Mounting Screw Befestigungsschraube
AFM90-LN1106-D050-A22-Z05	●	50	5	22	40	10	LNMT 1106..	4015-M3.5x11	80-T15	2508-M10x30
AFM90-LN1106-D063-A22-Z06	●	63	6	22	40	10				2510-M12x35
AFM90-LN1106-D080-A27-Z08	●	80	8	27	50	10				2514-M16x35
AFM90L-LN1106-D080-A27-Z08	●	80	8	27	50	10				-
AFM90-LN1106-D100-A32-Z09	●	100	9	32	50	10				2506-M8x30
AFM90L-LN1106-D100-A32-Z09	●	100	9	32	50	10				2508-M10x30
AFM90-LN1106-D125-B40-Z10	●	125	10	40	63	10	T490 LNMT 1306..	4015-M4x11	80-T15	2510-M12x35
AFM90-LN1306-D040-A16-Z04-H	●	40	4	16	40	12.5				2514-M16x35
AFM90-LN1306-D050-A22-Z05-H	●	50	5	22	40	12.5				-
AFM90-LN1306-D063-A22-Z06-H	●	63	6	22	40	12.5				2506-M8x30
AFM90-LN1306-D080-A27-Z07-H	●	80	7	27	50	12.5				2508-M10x30
AFM90-LN1306-D100-A32-Z08-H	●	100	8	32	50	12.5				2510-M12x35
AFM90L-LN1506-D040-A16-Z04	●	40	4	16	40	14	LNMT 1506..	4015-M4x11	80-T20	2514-M16x35
AFM90-LN1506-D040-A16-Z04	○	40	4	16	40	14				2506-M8x30
AFM90-LN1506-D050-A22-Z05	○	50	5	22	40	14				2508-M10x30
AFM90-LN1506-D063-A22-Z06	○	63	6	22	40	14				2510-M12x35
AFM90-LN1506-D080-A27-Z07	○	80	7	27	50	14				2514-M16x35
AFM90-LN1607-D050-A22-Z03-H	●	50	3	22	40	16				T490 LNHT 1607..
AFM90-LN1607-D063-A22-Z04-H	○	63	4	22	40	16	2510-M12x35			
AFM90-LN1607-D080-A27-Z05-H	●	80	5	27	50	16	2514-M16x35			
AFM90-LN1607-D100-A32-Z06-H	●	100	6	32	50	16	-			

R: Sağ / Right / Rechts L: Sol/Left/Links

● Stokta / In Stock / Auf Lager ○ Stokta Yok / Non Stock Item / Kein Lagerartikel, Lieferzeit auf Anfrage
ISCR Ucuna Uygunudur. / Compatiple with ISCR Insert. Kompatibel mit ISCR Wendepplatten.

Sipariş Örneği/Ordering Example/Bestellbeispiel

1 ad./pcs./stück AFM90-LN1106-D050-A22-Z05

Kesme Hesabı : S 331 / Cutting Calculation : P 331 / Schnittberechnung : 331

Montaj Ölçüleri : S 328 / Mounting Reference : P 328 / Montagehinweis : 328

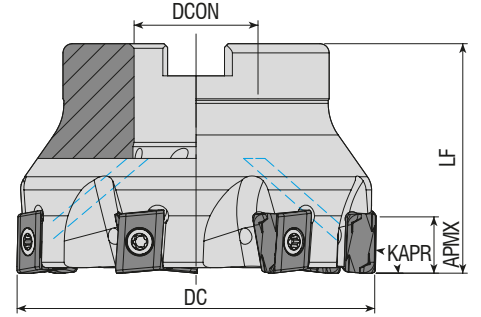

Takım Kodu Ordering Code Bestell-Bezeichnung	Stok Stock Lager	Takım Ölçüleri (mm) Dimension (mm) Abmessung (mm)					Kesici Uç Insert Wendeschneidplatte	Yedek Parçaları / Spare Parts / Ersatzteile		
		DC	ZEFP	DCON	LF	APMX		Sıkma Vidası Screw Schraube	Tork Anahtar Torx Key Torx-Schlüssel	Montaj Vidası Mounting Screw Befestigungsschraube
AFM90-LN1306W-D050-A22-Z05-H	●	50	5	22	40	12	LNHU 1306..	4115-M4x12	80-T15	2508-M10x30
AFM90-LN1306W-D063-A22-Z06-H	●	63	6	22	40	12				
AFM90-LN1306W-D080-A27-Z07-H	●	80	7	27	50	12				2510-M12x35

WLTR Ucuna Uygunudur. / Compatible with WLTR Insert. Kompatibel mit WLTR Wendeplatten.

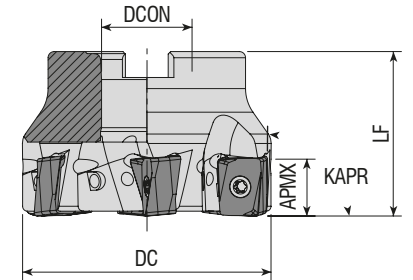

Takım Kodu Ordering Code Bestell-Bezeichnung	Stok Stock Lager	Takım Ölçüleri (mm) Dimension (mm) Abmessung (mm)					Kesici Uç Insert Wendeschneidplatte	Yedek Parçaları / Spare Parts / Ersatzteile		
		DC	ZEFP	DCON	LF	APMX		Sıkma Vidası Screw Schraube	Tork Anahtar Torx Key Torx-Schlüssel	Montaj Vidası Mounting Screw Befestigungsschraube
AFM90-LN1307-D050-A22-Z04-H	●	50	4	22	40	13	LNGX 1307..	1315-M4x11	80-T15	2508-M10x30
AFM90-LN1307-D063-A22-Z06-H	●	63	6	22	40	13				
AFM90-LN1307-D080-A27-Z07-H	●	80	7	27	50	13				2510-M12x35
AFM90-LN1307-D100-A32-Z08-H	●	100	8	32	50	13				2514-M16x35

R: Sağ / Right / Rechts L: Sol/Left/Links

● Stokta / In Stock / Auf Lager ○ Stokta Yok / Non Stock Item / Kein Lagerartikel, Lieferzeit auf Anfrage

WLTR Ucuna Uygunudur. / Compatible with WLTR Insert. Kompatibel mit WLTR Wendeplatten.

Sipariş Örneği/Ordering Example/Bestellbeispiel

1 ad./pcs./stück AFM90-LN1306W-D050-A22-Z05-H

Kesme Hesabı : S 331 / Cutting Calculation : P 331 / Schnittberechnung : 331

Montaj Ölçüleri : S 328 / Mounting Reference : P 328 / Montagehinweis : 328

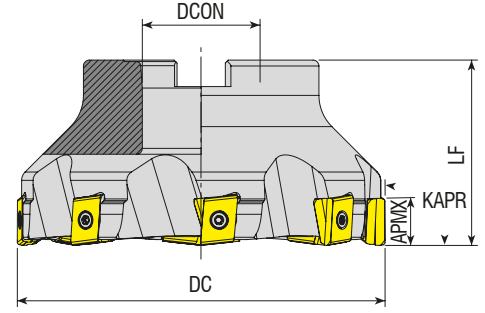

Takım Kodu Ordering Code Bestell-Bezeichnung	Stok Stock Lager	Takım Ölçüleri (mm) Dimension (mm) Abmessung (mm)					Kesici Uç Insert Wendeschneidplatte	Yedek Parçaları / Spare Parts / Ersatzteile		
		DC	ZEFP	DCON	LF	APMX		Sıkma Vidası Screw Schraube	Tork Anahtar Torx Key Torx-Schlüssel	Montaj Vidası Mounting Screw Befestigungsschraube
AFM90-LN15Z-D050-A22-Z04	●	50	4	22	40	15	LNKT 1506..	4015-M4x11	80-T15	2508-M10x30
AFM90-LN15Z-D063-A22-Z05	●	63	5	22	40	15				
AFM90-LN15Z-D080-A27-Z06	●	80	6	27	50	15				
AFM90-LN15Z-D100-A32-Z07	●	100	7	32	50	15				
AFM90-LN15Z-D125-B40-Z08	●	125	8	40	63	15				

ZCC Ucuna Uygundur. / Compatible with ZCC Insert. Kompatibel mit ZCC Wendepplatten.

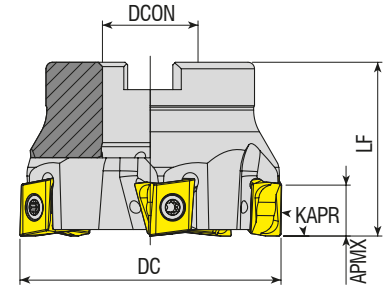

Takım Kodu Ordering Code Bestell-Bezeichnung	Stok Stock Lager	Takım Ölçüleri (mm) Dimension (mm) Abmessung (mm)					Kesici Uç Insert Wendeschneidplatte	Yedek Parçaları / Spare Parts / Ersatzteile		
		DC	ZEFP	DCON	LF	APMX		Sıkma Vidası Screw Schraube	Tork Anahtar Torx Key Torx-Schlüssel	Montaj Vidası Mounting Screw Befestigungsschraube
AFM90-LO1207-D040-A16-Z04-H	●	40	4	16	40	11	LOGU 1207..	3015-M4x11	80-T15	2506-M8x30
AFM90-LO1207-D050-A22-Z05-H	●	50	5	22	40	11				2508-M10x30
AFM90-LO1207-D063-A22-Z05-H	●	63	5	22	40	11				

R: Sağ / Right / Rechts L: Sol/Left/Links
● Stokta / In Stock / Auf Lager ○ Stokta Yok / Non Stock Item / Kein Lagerartikel, Lieferzeit auf Anfrage
MTSBSH Ucuna Uygundur. / Compatible with MTSBSH Insert. Kompatibel mit MTSBSH Wendepplatten.

Sipariş Örneği/Ordering Example/Bestellbeispiel
1 ad./pcs./stück AFM90-LN15Z-D050-A22-Z04
Kesme Hesabı : S 331 / Cutting Calculation : P 331 / Schnittberechnung : 331
Montaj Ölçüleri : S 328 / Mounting Reference : P 328 / Montagehinweis : 328

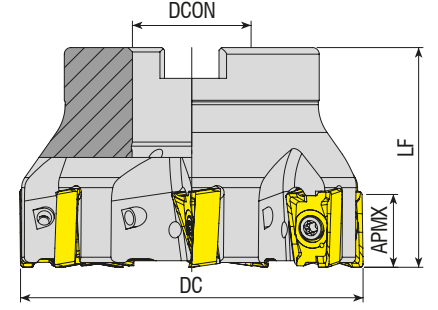

Takım Kodu Ordering Code Bestell-Bezeichnung	Stok Stock Lager	Takım Ölçüleri (mm) Dimension (mm) Abmessung (mm)					Kesici Uç Insert Wendeschneidplatte	Yedek Parçaları / Spare Parts / Ersatzteile		
		DC	ZEFP	DCON	LF	APMX		Sıkma Vidası Screw Schraube	Tork Anahtar Torx Key Torx-Schlüssel	Montaj Vidası Mounting Screw Befestigungsschraube
AFM90-LN15T6-D050-A22-Z05-H	●	50	5	22	40	15.5	LNGU 15T6..	4015-M4x12	80-T15	2508-M10x30
AFM90-LN15T6-D063-A22-Z06-H	●	63	6	22	40	15.5				
AFM90-LN15T6-D080-A27-Z07-H	●	80	7	27	50	15.5				2510-M12x35

KNMTL Ucuna Uygun. / Compatible with KNMTL Insert. Kompatibel mit KNMTL Wendepplatten.

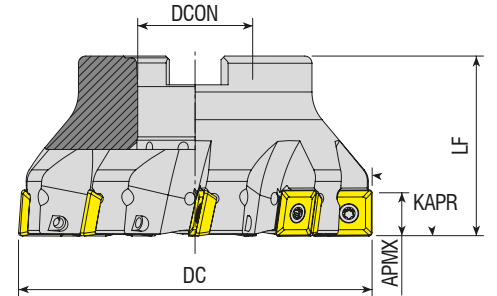

Takım Kodu Ordering Code Bestell-Bezeichnung	Stok Stock Lager	Takım Ölçüleri (mm) Dimension (mm) Abmessung (mm)					Kesici Uç Insert Wendeschneidplatte	Yedek Parçaları / Spare Parts / Ersatzteile		
		DC	ZEFP	DCON	LF	APMX		Sıkma Vidası Screw Schraube	Tork Anahtar Torx Key Torx-Schlüssel	Montaj Vidası Mounting Screw Befestigungsschraube
AFM90-R290.12-D050-A22-Z04-H	●	50	4	22	40	10.7	R290-12T3..	4015-M3.5x11	80-T15	2508-M10x30
AFM90-R290.12-D063-A22-Z05-H	●	63	5	22	40	10.7				
AFM90-R290.12-D080-A27-Z07-H	●	80	7	27	50	10.7				2510-M12x35
AFM90-R290.12-D100-A32-Z09-H	●	100	9	32	50	10.7				2514-M16x35
AFM90-R290.12-D125-B40-Z11	●	125	11	40	63	10.7				-

R: Sağ / Right / Rechts L: Sol/Left/Links

● Stokta / In Stock / Auf Lager ○ Stokta Yok / Non Stock Item / Kein Lagerartikel, Lieferzeit auf Anfrage
SNDVK Ucuna Uygun. / Compatible with SNDVK Insert. Kompatibel mit SNDVK Wendepplatten.

Sipariş Örneği/Ordering Example/Bestellbeispiel

1 ad./pcs./stück AFM90-LN15T6-D050-A22-Z05-H

Kesme Hesabı : S 331 / Cutting Calculation : P 331 / Schnittberechnung : 331

Montaj Ölçüleri : S 328 / Mounting Reference : P 328 / Montagehinweis : 328

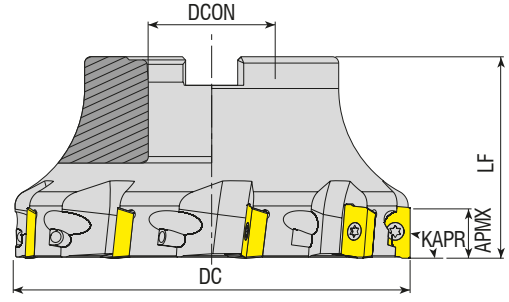

Takım Kodu Ordering Code Bestell-Bezeichnung	Stok Stock Lager	Takım Ölçüleri (mm) Dimension (mm) Abmessung (mm)					Kesici Uç Insert Wendeschneidplatte	Yedek Parçaları / Spare Parts / Ersatzteile		
		DC	ZEFP	DCON	LF	APMX		Sıkma Vidası Screw Schraube	Tork Anahtar Torx Key Torx-Schlüssel	Montaj Vidası Mounting Screw Befestigungsschraube
AFM90-R390.11-D040-A16-Z05-H	●	40	5	16	40	10	R390-11T3..	3008-M2.5x6	80-T08	2506-M8x30
AFM90-R390.11-D050-A22-Z06-H	●	50	6	22	40	10				2508-M10x30
AFM90-R390.11-D063-A22-Z07-H	●	63	7	22	40	10				2510-M12x35
AFM90-R390.11-D080-A27-Z09-H	●	80	9	27	50	10	R390-1704..	4015-M3.5x11	80-T15	2506-M8x30
AFM90-R390.17-D040-A16-Z04-H	●	40	4	16	40	15.4				2508-M10x30
AFM90-R390.17-D050-A22-Z05-H	●	50	5	22	40	15.4				2510-M12x35
AFM90-R390.17-D063-A22-Z06-H	●	63	6	22	40	15.4				2514-M16x35
AFM90-R390.17-D080-A27-Z07-H	●	80	7	27	50	15.4				-
AFM90-R390.17-D100-A32-Z08-H	●	100	8	32	50	15.4				-
AFM90-R390.17-D125-B40-Z09	●	125	9	40	63	15.4	R390-1806..	4015-M4x11	80-T15	2508-M10x30
AFM90-R390.18-D050-A22-Z04-H	●	50	4	22	40	15.4				2510-M12x35
AFM90-R390.18-D063-A22-Z05-H	●	63	5	22	40	15.4				2514-M16x35
AFM90-R390.18-D080-A27-Z06-H	●	80	6	27	50	15.4				-
AFM90-R390.18-D100-A32-Z07-H	●	100	7	32	50	15.4				-
AFM90-R390.18-D125-B40-Z08	●	125	8	40	63	15.4	-			

SNDVK Ucuna Uygunudur. / Compatible with SNDVK Insert. Kompatibel mit SNDVK Wendeplatten.

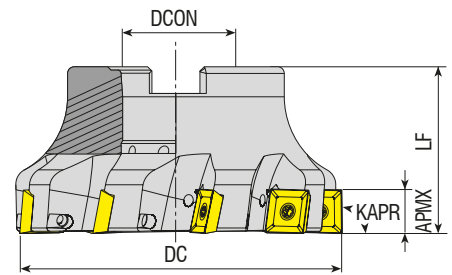

Takım Kodu Ordering Code Bestell-Bezeichnung	Stok Stock Lager	Takım Ölçüleri (mm) Dimension (mm) Abmessung (mm)					Kesici Uç Insert Wendeschneidplatte	Yedek Parçaları / Spare Parts / Ersatzteile		
		DC	ZEFP	DCON	LF	APMX		Sıkma Vidası Screw Schraube	Tork Anahtar Torx Key Torx-Schlüssel	Montaj Vidası Mounting Screw Befestigungsschraube
AFM90-490R14-D050-A22-Z04-H	●	50	4	22	40	10	490R-1404..	4015-M3.5x11	80-T15	2508-M10x30
AFM90-490R14-D063-A22-Z05-H	●	63	5	22	40	10				2510-M12x35
AFM90-490R14-D080-A27-Z07-H	●	80	7	27	50	10				-

R: Sağ / Right / Rechts L: Sol/Left/Links

● Stokta / In Stock / Auf Lager ○ Stokta Yok / Non Stock Item / Kein Lagerartikel, Lieferzeit auf Anfrage
SNDVK Ucuna Uygunudur. / Compatible with SNDVK Insert. Kompatibel mit SNDVK Wendeplatten.

Sipariş Örneği/Ordering Example/Bestellbeispiel

1 ad./pcs./stück AFM90-R390.11-D040-A16-Z05-H

Kesme Hesabı : S 331 / Cutting Calculation : P 331 / Schnittberechnung : 331

Montaj Ölçüleri : S 328 / Mounting Reference : P 328 / Montagehinweis : 328

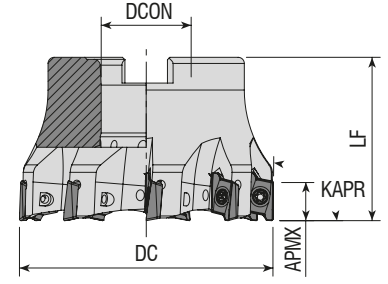

Takım Kodu Ordering Code Bestell-Bezeichnung	Stok Stock Lager	Takım Ölçüleri (mm) Dimension (mm) Abmessung (mm)					Kesici Uç Insert Wendeschneidplatte	Yedek Parçaları / Spare Parts / Ersatzteile		
		DC	ZEFP	DCON	LF	APMX		Sıkma Vidası Screw Schraube	Tork Anahtar Torx Key Torx-Schlüssel	Montaj Vidası Mounting Screw Befestigungsschraube
AFM90-RT10-D040-A16-Z06-H	●	40	6	16	40	10	RT 1003..	3008-M2.5x6	80-T08	2506-M8x30
AFM90-RT10-D050-A22-Z07-H	●	50	7	22	40	10				2407-M10x30
AFM90-RT10-D063-A22-Z09-H	●	63	9	22	40	10				

SFTY Ucuna Uygunudur. / Compatible with SFTY Insert. Kompatibel mit SFTY Wendeplatten.

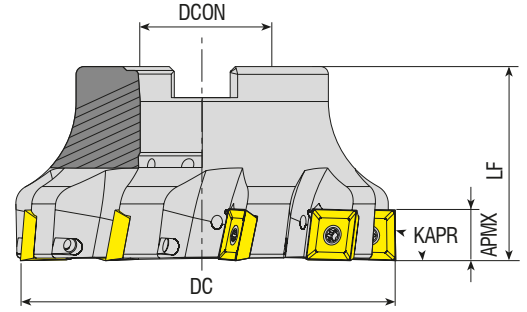

Takım Kodu Ordering Code Bestell-Bezeichnung	Stok Stock Lager	Takım Ölçüleri (mm) Dimension (mm) Abmessung (mm)					Kesici Uç Insert Wendeschneidplatte	Yedek Parçaları / Spare Parts / Ersatzteile		
		DC	ZEFP	DCON	LF	APMX		Sıkma Vidası Screw Schraube	Tork Anahtar Torx Key Torx-Schlüssel	Montaj Vidası Mounting Screw Befestigungsschraube
AFM90-SD09M4-D040-A16-Z04-H	●	40	4	16	40	9	SD.. 09M4..	4015-M3.5x11	80-T15	2406-M8x30
AFM90-SD09M4-D050-A22-Z05-H	●	50	5	22	40	9				2508-M10x30
AFM90-SD09M4-D063-A22-Z06-H	●	63	6	22	40	9				2510-M12x35
AFM90-SD09M4-D080-A27-Z07-H	●	80	7	27	50	9	SD.. 1305..	1020-M5x11	80-T20	2408-M10x30
AFM90-SD1305-D050-A22-Z04-H	●	50	4	22	40	13				2508-M10x30
AFM90-SD1305-D063-A22-Z05-H	●	63	5	22	40	13				2510-M12x35
AFM90-SD1305-D080-A27-Z06-H	●	80	6	27	50	13				2514-M16x35
AFM90-SD1305-D100-A32-Z07-H	●	100	7	32	50	13				-
AFM90-SD1305-D125-B40-Z08	●	125	8	40	63	13				
AFM90-SD1305-D160-C40-Z10	●	160	10	40	63	13				

R: Sağ / Right / Rechts L: Sol/Left/Links

● Stokta / In Stock / Auf Lager ○ Stokta Yok / Non Stock Item / Kein Lagerartikel, Lieferzeit auf Anfrage
KRLY Ucuna Uygunudur. / Compatible with KRLY Insert. Kompatibel mit KRLY Wendeplatten.

Sipariş Örneği/Ordering Example/Bestellbeispiel

1 ad./pcs./stück AFM90-RT10-D040-A16-Z06-H

Kesme Hesabı : S 331 / Cutting Calculation : P 331 / Schnittberechnung : 331

Montaj Ölçüleri : S 328 / Mounting Reference : P 328 / Montagehinweis : 328

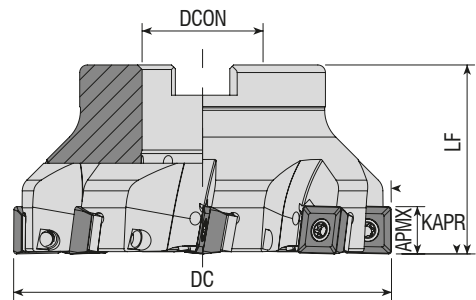

Takım Kodu Ordering Code Bestell-Bezeichnung	Stok Stock Lager	Takım Ölçüleri (mm) Dimension (mm) Abmessung (mm)					Kesici Uç Insert Wendeschneidplatte	Yedek Parçaları / Spare Parts / Ersatzteile				
		DC	ZEP	DCON	LF	APMX		Altlık Screw Unterlage	Baskı Parçası Wedge Clamp Spannpratze	Sıkma Vidası Screw Schraube	Tork Anahtar Torx Key Torx-Schlüssel	Montaj Vidası Mounting Screw Befestigungsschraube
AFM90S-SD1204-D050-A22-Z04-H	●	50	4	22	40	11	SDMT 1204..	AASD-3-0001	AAV-08-M3.5x8	4015-M3.5x12	80-T15	2408-M10x30
AFM90S-SD1204-D063-A22-Z05-H	●	63	5	22	40	11						2508-M10x30
AFM90S-SD1204-D080-A27-Z06-H	●	80	6	27	50	11						2510-M12x35
AFM90S-SD1204-D100-A32-Z08-H	●	100	8	32	50	11						2514-M16x35
AFM90S-SD1204-D125-B40-Z10	●	125	10	40	63	11						-
AFM90S-SD1204-D160-C40-Z12	●	160	12	40	63	11						-

DJT Ucuna Uygundur. / Compatible with DJT Insert. Kompatibel mit DJT Wendeplatten.

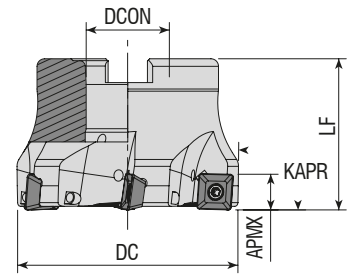

Takım Kodu Ordering Code Bestell-Bezeichnung	Stok Stock Lager	Takım Ölçüleri (mm) Dimension (mm) Abmessung (mm)					Kesici Uç Insert Wendeschneidplatte	Yedek Parçaları / Spare Parts / Ersatzteile		
		DC	ZEP	DCON	LF	APMX		Sıkma Vidası Screw Schraube	Tork Anahtar Torx Key Torx-Schlüssel	Montaj Vidası Mounting Screw Befestigungsschraube
AFM90-SE09-D040-A16-Z04-H	●	40	4	16	40	6.7	SEET 09T3..	3008-M3x8	80-T08	2506-M8x30
AFM90-SE09-D050-A22-Z05-H	●	50	5	22	40	6.7				2508-M10x30
AFM90-SE09-D063-A22-Z06-H	●	63	6	22	40	6.7				-

R: Sağ / Right / Rechts L: Sol/Left/Links

● Stokta / In Stock / Auf Lager ○ Stokta Yok / Non Stock Item / Kein Lagerartikel, Lieferzeit auf Anfrage

ZCC Ucuna Uygundur. / Compatible with ZCC Insert. Kompatibel mit ZCC Wendeplatten.

Sipariş Örneği/Ordering Example/Bestellbeispiel

1 ad./pcs./stück AFM90S-SD1204-D050-A22-Z04-H

Kesme Hesabı : S 331 / Cutting Calculation : P 331 / Schnittberechnung : 331

Montaj Ölçüleri : S 328 / Mounting Reference : P 328 / Montagehinweis : 328

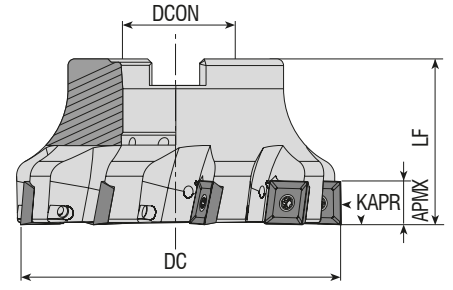

Takım Kodu Ordering Code Bestell-Bezeichnung	Stok Stock Lager	Takım Ölçüleri (mm) Dimension (mm) Abmessung (mm)					Kesici Uç Insert Wendeschneidplatte	Yedek Parçaları / Spare Parts / Ersatzteile		
		DC	ZEFP	DCON	LF	APMX		Sıkma Vidası Screw Schraube	Tork Anahtar Torx Key Torx-Schlüssel	Montaj Vidası Mounting Screw Befestigungsschraube
AFM90-SE12-D050-A22-Z04-H	●	50	4	22	40	12	SEET 1203..	4015-M3.5x11	80-T15	2508-M10x30 2510-M12x35 2514-M16x35 -
AFM90-SE12-D063-A22-Z05-H	●	63	5	22	40	12				
AFM90-SE12-D080-A27-Z07-H	●	80	7	27	50	12				
AFM90-SE12-D100-A32-Z09-H	●	100	9	32	50	12				
AFM90-SE12-D125-B40-Z11	●	125	11	40	63	12				

ZCC Ucuına Uyğundur. / Compatible with ZCC Insert. Kompatibel mit ZCC Wendepfatten.

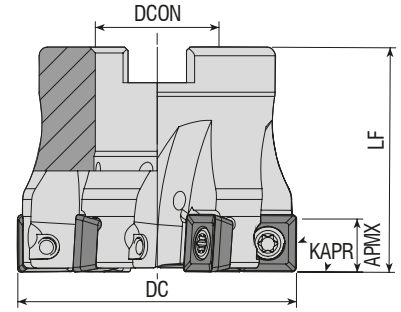

Takım Kodu Ordering Code Bestell-Bezeichnung	Stok Stock Lager	Takım Ölçüleri (mm) Dimension (mm) Abmessung (mm)					Kesici Uç Insert Wendeschneidplatte	Yedek Parçaları / Spare Parts / Ersatzteile		
		DC	ZEFP	DCON	LF	APMX		Sıkma Vidası Screw Schraube	Tork Anahtar Torx Key Torx-Schlüssel	Montaj Vidası Mounting Screw Befestigungsschraube
AFM90-SP1004-D040-A16-Z04-H	●	40	4	16	40	9.4	SPMT 1004.. XPMT 1004.. QPMR 1004.. QPMT 1004..	4015-M4x10	80-T15	2506-M8x30 2508-M10x30 2510-M12x35 2514-M16x35
AFM90-SP1004-D050-A22-Z04-H	●	50	4	22	40	9.4				
AFM90-SP1004-D050-A22-Z06-H	●	50	6	22	40	9.4				
AFM90-SP1004-D063-A22-Z05-H	●	63	5	22	40	9.4				
AFM90-SP1004-D080-A27-Z07-H	●	80	7	27	50	9.4				
AFM90-SP1004-D100-A32-Z08-H	●	100	8	32	50	9.4				

R: Sağ / Right / Rechts L: Sol/Left/Links
● Stokta / In Stock / Auf Lager ○ Stokta Yok / Non Stock Item / Kein Lagerartikel, Lieferzeit auf Anfrage
ISCR Ucuına Uyğundur. / Compatible with ISCR Insert. Kompatibel mit ISCR Wendepfatten.

Sipariş Örneği/Ordering Example/Bestellbeispiel
1 ad./pcs./stück AFM90-SE12-D050-A22-Z04-H

Kesme Hesabı : S 331 / Cutting Calculation : P 331 / Schnittberechnung : 331
Montaj Ölçüleri : S 328 / Mounting Reference : P 328 / Montagehinweis : 328

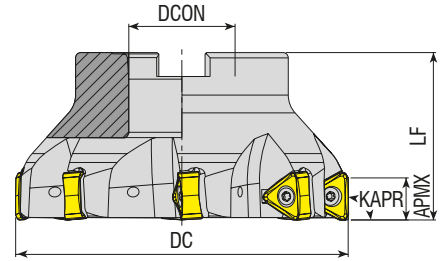

Takım Kodu Ordering Code Bestell-Bezeichnung	Stok Stock Lager	Takım Ölçüleri (mm) Dimension (mm) Abmessung (mm)					Kesici Uç Insert Wendeschneidplatte	Yedek Parçaları / Spare Parts / Ersatzteile		
		DC	ZEFP	DCON	LF	APMX		Sıkma Vidası Screw Schraube	Tork Anahtar Torx Key Torx-Schlüssel	Montaj Vidası Mounting Screw Befestigungsschraube
AFM90-TN2207-D063-A22-Z04-H	●	63	4	22	40	15	TN.X 2207..	1120-M4.5x12	80-T20	2508-M10x30
AFM90-TN2207-D080-A27-Z05-H	●	80	5	27	50	15				2510-M12x35
AFM90-TN2207-D100-B32-Z06	●	100	6	32	50	15				-
AFM90-TN2207-D125-B40-Z08	●	125	8	40	63	15				-

TGTC Ucuna Uygundur. / Compatible with TGTC Insert. Kompatibel mit TGTC Wendeplatten.

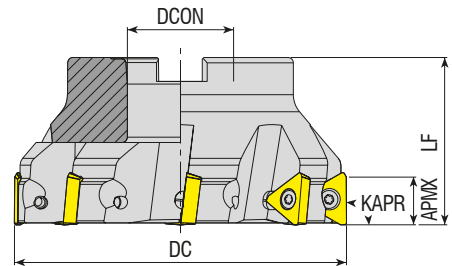

Takım Kodu Ordering Code Bestell-Bezeichnung	Stok Stock Lager	Takım Ölçüleri (mm) Dimension (mm) Abmessung (mm)					Kesici Uç Insert Wendeschneidplatte	Yedek Parçaları / Spare Parts / Ersatzteile		
		DC	ZEFP	DCON	LF	APMX		Sıkma Vidası Screw Schraube	Tork Anahtar Torx Key Torx-Schlüssel	Montaj Vidası Mounting Screw Befestigungsschraube
AFM90-TP2205-D063-A22-Z04	●	63	4	22	40	18	TPKT 2205..	1120-M4.5x12	80-T20	2508-M10x30
AFM90-TP2205-D080-A27-Z06	●	80	6	27	50	18				2510-M12x35
AFM90-TP2205-D100-A32-Z07	●	100	7	32	50	18				2514-M16x35
AFM90-TP2205-D125-B40-Z08	●	125	8	40	63	18				-
AFM90-TP2205-D160-C40-Z09	●	160	9	40	63	18				-
AFM90-TP2205-D200-C60-Z12	●	200	12	60	63	18				-

R: Sağ / Right / Rechts L: Sol/Left/Links

● Stokta / In Stock / Auf Lager ○ Stokta Yok / Non Stock Item / Kein Lagerartikel, Lieferzeit auf Anfrage

TGTC Ucuna Uygundur. / Compatible with TGTC Insert. Kompatibel mit TGTC Wendeplatten.

Sipariş Örneği/Ordering Example/Bestellbeispiel

1 ad./pcs./stück AFM90-TN2207-D063-A22-Z04-H

Kesme Hesabı : S 331 / Cutting Calculation : P 331 / Schnittberechnung : 331

Montaj Ölçüleri : S 328 / Mounting Reference : P 328 / Montagehinweis : 328

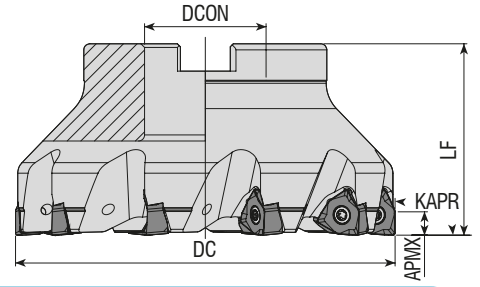

Takım Kodu Ordering Code Bestell-Bezeichnung	Stok Stock Lager	Takım Ölçüleri (mm) Dimension (mm) Abmessung (mm)					Kesici Uç Insert Wendeschneidplatte	Yedek Parçaları / Spare Parts / Ersatzteile		
		DC	ZEFP	DCON	LF	APMX		Sıkma Vidası Screw Schraube	Tork Anahtar Torx Key Torx-Schlüssel	Montaj Vidası Mounting Screw Befestigungsschraube
AFM90-WN0604Z-D040-A16-Z04-H	●	40	4	16	16	5.7	WNHU 0604..	3008-M3x8	80-T08	2506-M8x30
AFM90-WN0604Z-D050-A22-Z05-H	●	50	5	22	22	5.7				2508-M10x30
AFM90-WN0604Z-D063-A22-Z06-H	●	63	6	22	22	5.7				2510-M12x35
AFM90-WN0604Z-D080-A27-Z07-H	●	80	7	27	27	5.7				2514-M16x35
AFM90-WN0604Z-D100-A32-Z09-H	●	100	9	32	32	5.7				-
AFM90-WN0806Z-D050-A22-Z04-H	●	50	4	22	22	7.7	WNHU 0806..	4015-M4x11	80-T15	2508-M10x30
AFM90-WN0806Z-D063-A22-Z05-H	●	63	5	22	22	7.7				2510-M12x35
AFM90-WN0806Z-D080-A27-Z06-H	●	80	6	27	27	7.7				2514-M16x35
AFM90-WN0806Z-D100-A32-Z08-H	●	100	8	32	32	7.7				-
AFM90-WN0806Z-D125-B40-Z10	●	125	10	40	40	7.7				-
AFM90-WN0806Z-D160-C40-Z12	●	160	12	40	40	7.7	-	-	-	

ZCC Ucuna Uygundur. / Compatible with ZCC Insert. Kompatibel mit ZCC Wendeplatten.

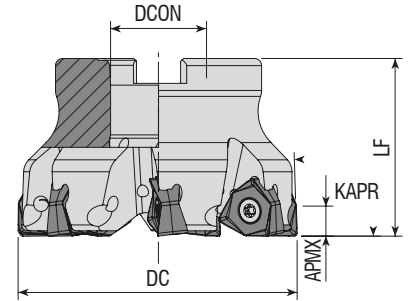

Takım Kodu Ordering Code Bestell-Bezeichnung	Stok Stock Lager	Takım Ölçüleri (mm) Dimension (mm) Abmessung (mm)					Kesici Uç Insert Wendeschneidplatte	Yedek Parçaları / Spare Parts / Ersatzteile		
		DC	ZEFP	DCON	LF	APMX		Sıkma Vidası Screw Schraube	Tork Anahtar Torx Key Torx-Schlüssel	Montaj Vidası Mounting Screw Befestigungsschraube
AFM90-WN0806-D050-A16-Z04-H	●	50	4	16	40	8	WNMX 080608	1615-M5x14	80-T15	2506-M8x30
AFM90-WN0806-D063-A22-Z05-H	●	63	5	22	40	8				2508-M10x30
AFM90-WN0806-D080-A27-Z07-H	●	80	7	27	50	8				2510-M12x35

R: Sağ / Right / Rechts L: Sol/Left/Links

● Stokta / In Stock / Auf Lager ○ Stokta Yok / Non Stock Item / Kein Lagerartikel, Lieferzeit auf Anfrage
KYCR-JD Ucuna Uygundur. / Compatible with KYCR-JD Insert. Kompatibel mit KYCR-JD Wendeplatten.

Sipariş Örneği/Ordering Example/Bestellbeispiel

1 ad./pcs./stück AFM90-WN0604Z-D040-A16-Z04-H

Kesme Hesabı : S 331 / Cutting Calculation : P 331 / Schnittberechnung : 331

Montaj Ölçüleri : S 328 / Mounting Reference : P 328 / Montagehinweis : 328

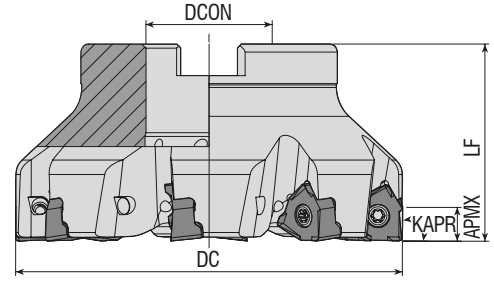

Takım Kodu Ordering Code Bestell-Bezeichnung	Stok Stock Lager	Takım Ölçüleri (mm) Dimension (mm) Abmessung (mm)					Kesici Uç Insert Wendeschneidplatte	Yedek Parçaları / Spare Parts / Ersatzteile			
		DC	ZEPF	DCON	LF	APMX		Sıkma Vidası Screw Schraube	Tork Anahtar Torx Key Torx-Schlüssel	Montaj Vidası Mounting Screw Befestigungsschraube	
AFM90-XN0403-D040-A16-Z05-H	●	40	5	16	40	4	XNEX 0403..	4008-M2.5x6	80-T08	2506-M8x30	
AFM90-XN0806-D050-A22-Z04-H	●	50	4	22	40	7.5				XNEX 0806..	4015-M4x11
AFM90-XN0806-D063-A22-Z05-H	●	63	5	22	40	7.5		2510-M12x35			
AFM90-XN0806-D080-A27-Z07-H	●	80	7	27	50	7.5		2514-M16x35			
AFM90-XN0806-D100-A32-Z08-H	●	100	8	32	50	7.5					

SC Ucuna Uygunur. / Compatible with SC Insert. Kompatibel mit SC Wendepplatten.

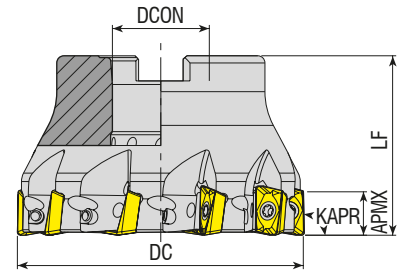

Takım Kodu Ordering Code Bestell-Bezeichnung	Stok Stock Lager	Takım Ölçüleri (mm) Dimension (mm) Abmessung (mm)					Kesici Uç Insert Wendeschneidplatte	Yedek Parçaları / Spare Parts / Ersatzteile		
		DC	ZEPF	DCON	LF	APMX		Sıkma Vidası Screw Schraube	Tork Anahtar Torx Key Torx-Schlüssel	Montaj Vidası Mounting Screw Befestigungsschraube
AFM90-X012-D040-A16-Z05-H	●	40	5	16	40	11	XO.. 1204..	3010-M3.5x9	80-T10	2506-M8x30
AFM90-X012-D050-A22-Z07-H	●	50	7	22	40	11				2508-M10x30
AFM90-X012-D063-A22-Z08-H	●	63	8	22	40	11				2510-M12x35
AFM90-X012-D080-A27-Z10-H	●	80	10	27	50	11				2514-M16x35
AFM90-X012-D100-A32-Z12-H	●	100	12	32	50	11				

R: Sağ / Right / Rechts L: Sol/Left/Links
● Stokta / In Stock / Auf Lager ○ Stokta Yok / Non Stock Item / Kein Lagerartikel, Lieferzeit auf Anfrage
SC Ucuna Uygunur. / Compatible with SC Insert. Kompatibel mit SC Wendepplatten.

Sipariş Örneği/Ordering Example/Bestellbeispiel
1 ad./pcs./stück AFM90-XN0403-D040-A16-Z05-H
Kesme Hesabı : S 331 / Cutting Calculation : P 331 / Schnittberechnung : 331
Montaj Ölçüleri : S 328 / Mounting Reference : P 328 / Montagehinweis : 328

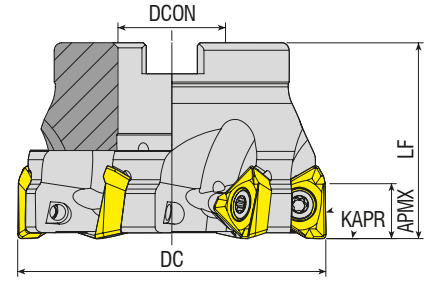

Takım Kodu Ordering Code Bestell-Bezeichnung	Stok Stock Lager	Takım Ölçüleri (mm) Dimension (mm) Abmessung (mm)					Kesici Uç Insert Wendeschneidplatte	Yedek Parçaları / Spare Parts / Ersatzteile		
		DC	ZEFP	DCON	LF	APMX		Sıkma Vidası Screw Schraube	Tork Anahtar Torx Key Torx-Schlüssel	Montaj Vidası Mounting Screw Befestigungsschraube
AFM90-3P1004-D040-A16-Z05-H	●	40	5	16	40	7	3PKT 1004..	1108-M2.5x6	80-T08	2506-M8x30
AFM90-3P1004-D050-A22-Z06-H	●	50	6	22	40	7				
AFM90-3P1505-D050-A22-Z04-H	●	50	4	22	40	11	3PKT 1505..	1115-M4x10	80-T15	2508-M10x30
AFM90-3P1505-D050-A22-Z05-H	●	50	5	22	40	11				
AFM90-3P1505-D063-A22-Z04-H	●	63	4	22	40	11				
AFM90-3P1505-D063-A22-Z06-H	●	63	6	22	40	11				
AFM90-3P1505-D080-A27-Z07-H	●	80	7	27	50	11				
AFM90-3P1505-D100-A32-Z08-H	●	100	8	32	50	11				
AFM90-3P1505-D125-B40-Z10	●	125	10	40	63	11				
										2510-M12x35
										2514-M16x35
										-

TGTC Ucuna Uygunudur. / Compatible with TGTC Insert. Kompatibel mit TGTC Wendepplatten.

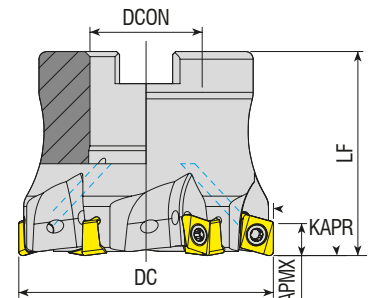

Takım Kodu Ordering Code Bestell-Bezeichnung	Stok Stock Lager	Takım Ölçüleri (mm) Dimension (mm) Abmessung (mm)					Kesici Uç Insert Wendeschneidplatte	Yedek Parçaları / Spare Parts / Ersatzteile		
		DC	ZEFP	DCON	LF	APMX		Sıkma Vidası Screw Schraube	Tork Anahtar Torx Key Torx-Schlüssel	Montaj Vidası Mounting Screw Befestigungsschraube
AFM90-4N06-D040-A16-Z05-H	●	40	5	16	40	6	4NKT 0603..	1108-M3x6.8	80-T08	2506-M8x30
AFM90-4N06-D050-A22-Z06-H	●	50	6	22	40	6				

R: Sağ / Right / Rechts L: Sol/Left/Links

● Stokta / In Stock / Auf Lager ○ Stokta Yok / Non Stock Item / Kein Lagerartikel, Lieferzeit auf Anfrage
TGTC Ucuna Uygunudur. / Compatible with TGTC Insert. Kompatibel mit TGTC Wendepplatten.

Sipariş Örneği/Ordering Example/Bestellbeispiel

1 ad./pcs./stück AFM90-3P1004-D040-A16-Z05-H

Kesme Hesabı : S 331 / Cutting Calculation : P 331 / Schnittberechnung : 331

Montaj Ölçüleri : S 328 / Mounting Reference : P 328 / Montagehinweis : 328

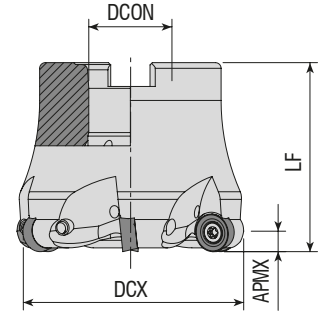

Takım Kodu Ordering Code Bestell-Bezeichnung	Stok Stock Lager	Takım Ölçüleri (mm) Dimension (mm) Abmessung (mm)					Kesici Uç Insert Wendeschneidplatte	Yedek Parçaları / Spare Parts / Ersatzteile		
		DCX	ZEFP	DCON	LF	APMX		Sıkma Vidası Screw Schraube	Tork Anahtar Torx Key Torx-Schlüssel	Montaj Vidası Mounting Screw Befestigungsschraube
AFMR-RC10T3-D040-A16-Z04-H	●	40	4	16	40	5	RC.. 10T3..	4015-M4x11	80-T15	2406-M8x30
AFMR-RC10T3-D050-A22-Z05-H	●	50	5	22	50	5				2508-M10x30
AFMR-RC10T3-D063-A22-Z06-H	●	63	6	22	50	5				

ZCC Ucuna Uygun. / Compatible with ZCC Insert. Kompatibel mit ZCC Wendeplatten.

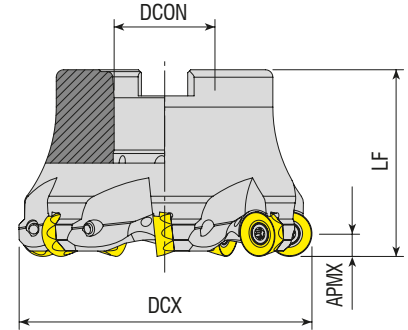

Takım Kodu Ordering Code Bestell-Bezeichnung	Stok Stock Lager	Takım Ölçüleri (mm) Dimension (mm) Abmessung (mm)					Kesici Uç Insert Wendeschneidplatte	Yedek Parçaları / Spare Parts / Ersatzteile		
		DCX	ZEFP	DCON	LF	APMX		Sıkma Vidası Screw Schraube	Tork Anahtar Torx Key Torx-Schlüssel	Montaj Vidası Mounting Screw Befestigungsschraube
AFMR-RC1204-D040-A16-Z04-H	●	40	4	16	40	6	RC.. 1204..	4015-M3.5x11	80-T15	2506-M8x30
AFMR-RC1204-D050-A22-Z05-H	●	50	5	22	50	6				2508-M10x30
AFMR-RC1204-D052-A22-Z05-H	●	52	5	22	50	6				
AFMR-RC1204-D063-A22-Z06-H	●	63	6	22	50	6				
AFMR-RC1204-D063-A27-Z06-H	●	80	7	27	50	6				
AFMR-RC1204-D080-A27-Z07-H	●	80	7	27	50	6				2510-M12x35

R: Sağ / Right / Rechts L: Sol/Left/Links
● Stokta / In Stock / Auf Lager ○ Stokta Yok / Non Stock Item / Kein Lagerartikel, Lieferzeit auf Anfrage
SNDVK Ucuna Uygun. / Compatible with SNDVK Insert. Kompatibel mit SNDVK Wendeplatten.

Sipariş Örneği/Ordering Example/Bestellbeispiel
1 ad./pcs./stück AFMR-RC10T3-D040-A16-Z04-H
Kesme Hesabı : S 331 / Cutting Calculation : P 331 / Schnittberechnung : 331
Montaj Ölçüleri : S 328 / Mounting Reference : P 328 / Montagehinweis : 328

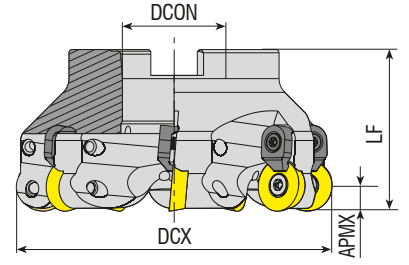

Takım Kodu Ordering Code Bestell-Bezeichnung	Stok Stock Lager	Takım Ölçüleri (mm) Dimension (mm) Abmessung (mm)					Kesici Uç Insert Wendeschneidplatte	Yedek Parçaları / Spare Parts / Ersatzteile				
		DCX	ZEPF	DCON	LF	APMX		Altık Screw Unterlage	Baskı Parçası Wedge Clamp Spannpratze	Sıkma Vidası Screw Schraube	Tork Anahtar Torx Key Torx-Schlüssel	Montaj Vidası Mounting Screw Befestigungsschraube
AFMR-RD0702-D050-A22-Z06-H	●	50	6	22	40	3.5	RD.. 0702..	3008-M2.5x6	-	-	80-T08	2407-M10x30
AFMR-RD0803-D050-A22-Z05-H	●	50	5	22	40	4	RD.. 0803..	3008-M3x8	-	-	80-T08	2407-M10x30
AFMRC-RD1003-D040-A16-Z04-H	●	40	4	16	40	5	RD.. 1003..					2406-M8x30
AFMRC-RD1003-D050-A22-Z05-H	●	50	5	22	50	5						2508-M10x30
AFMRC-RD1003-D052-A22-Z05	●	52	5	22	50	5						2510-M12x35
AFMRC-RD1003-D063-A22-Z06-H	●	63	6	22	50	5						2514-M16x35
AFMRC-RD1003-D080-A27-Z07-H	●	80	7	27	50	5						2508-M10x30
AFMRC-RD1003-D100-A32-Z08-H	●	100	8	32	50	5						2406-M8x30
AFMRC-RD10T3-D050-A22-Z05-H	●	50	5	22	50	5						RD.. 10T3..
AFMRC-RD10T3-D063-A22-Z06-H	●	63	6	22	50	5	RD.. 12T3..	4015-M3.5x11	ACK-15	4015-M3.5x11	80-T15	2508-M10x30
AFMRC-RD12T3-D040-A16-Z04-H	●	40	4	16	40	6						2406-M8x30
AFMRC-RD12T3-D050-A22-Z05-H	●	50	5	22	50	6						2508-M10x30
AFMRC-RD12T3-D052-A22-Z05-H	●	52	5	22	50	6						2510-M12x35
AFMRC-RD12T3-D063-A22-Z06-H	●	63	6	22	50	6						2514-M16x35
AFMRC-RD12T3-D080-A27-Z07-H	●	80	7	27	50	6						-
AFMRC-RD12T3-D100-A32-Z08-H	●	100	8	32	50	6						2406-M8x30
AFMRC-RD12T3-D125-B40-Z09	●	125	9	40	63	6	RD.. 1204..					2508-M10x30
AFMRC-RD1204-D040-A16-Z04-H	●	40	4	16	40	6						2510-M12x35
AFMRC-RD1204-D050-A22-Z05-H	●	50	5	22	50	6						2514-M16x35
AFMRC-RD1204-D052-A22-Z05-H	●	52	5	22	50	6						-
AFMRC-RD1204-D063-A22-Z06-H	●	63	6	22	50	6						2406-M8x30
AFMRC-RD1204-D080-A27-Z07-H	●	80	7	27	50	6						2508-M10x30
AFMRC-RD1204-D100-A32-Z07-H	●	100	7	32	50	6						2510-M12x35
AFMRC-RD1204-D100-A32-Z08-H	●	100	8	32	50	6	2514-M16x35					
AFMRC-RD1604-D050-A22-Z04-H	●	50	4	22	50	8	RD.. 1604..	4015-M4.5x11	ACK-05	4015-M4x11		2408-M10x30
AFMRC-RD1604-D052-A22-Z04-H	●	52	4	22	50	8						2508-M10x30
AFMRC-RD1604-D063-A22-Z05-H	●	63	5	22	50	8						2510-M12x35
AFMRC-RD1604-D066-A22-Z05-H	●	66	5	22	50	8						2514-M16x35
AFMRC-RD1604-D066-A27-Z05-H	●	66	5	27	50	8						-
AFMRC-RD1604-D080-A27-Z06-H	●	80	6	27	50	8						2408-M10x30
AFMRC-RD1604-D100-A32-Z07-H	●	100	7	32	50	8						2508-M10x30
AFMRC-RD1604-D100-A32-Z08-H	●	100	8	32	50	8						2510-M12x35
AFMRC-RD1604-D125-B40-Z07	●	125	7	40	63	8						2514-M16x35

R: Sağ / Right / Rechts L: Sol/Left/Links

● Stokta / In Stock / Auf Lager ○ Stokta Yok / Non Stock Item / Kein Lagerartikel, Lieferzeit auf Anfrage

ISO Ucuna Uygundur. / Compatible with ISO Insert. Kompatibel mit ISO Wendeschneidplatten.

Sipariş Örneği/Ordering Example/Bestellbeispiel

1 ad./pcs./stück AFMR-RD0702-D050-A22-Z06-H

Kesme Hesabı : S 331 / Cutting Calculation : P 331 / Schnittberechnung : 331

Montaj Ölçüleri : S 328 / Mounting Reference : P 328 / Montagehinweis : 328

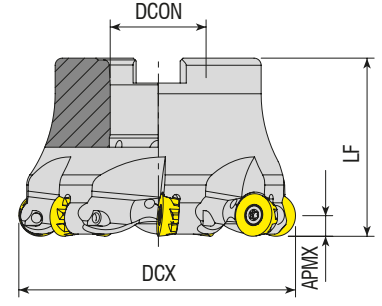

Takım Kodu Ordering Code Bestell-Bezeichnung	Stok Stock Lager	Takım Ölçüleri (mm) Dimension (mm) Abmessung (mm)					Kesici Uç Insert Wendeschneidplatte	Yedek Parçaları / Spare Parts / Ersatzteile			
		DCX	ZEFP	DCON	LF	APMX		Sıkma Vidası Screw Schraube	Tork Anahtar Torx Key Torx-Schlüssel	Montaj Vidası Mounting Screw Befestigungsschraube	
AFMR-RP10T3-D063-A22-Z06-H	●	63	6	22	40	5	RPNX 10T3..	4010-M3x8	80-T10	2508-M10x30	
AFMR-RP10T3-D080-A27-Z07-H	●	80	7	27	50	5				2510-M12x35	
AFMR-RP1204-D040-A16-Z04-H	●	40	4	16	40	6	RPNX 1204..	4015-M3.5x11	80-T15	2406-M8x30	
AFMR-RP1204-D080-A27-Z07-H	●	80	7	27	50	6				2510-M12x35	

CRTZT Ucuna Uygunudur. / Compatible with CRTZT Insert. Kompatibel mit CRTZT Wendeplatten.

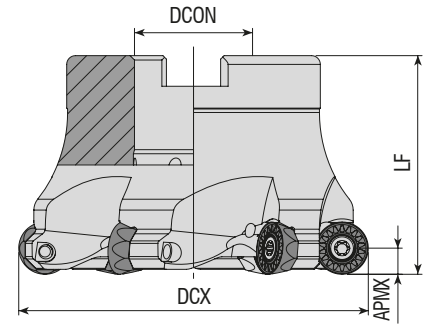

Takım Kodu Ordering Code Bestell-Bezeichnung	Stok Stock Lager	Takım Ölçüleri (mm) Dimension (mm) Abmessung (mm)					Kesici Uç Insert Wendeschneidplatte	Yedek Parçaları / Spare Parts / Ersatzteile			
		DCX	ZEFP	DCON	LF	APMX		Sıkma Vidası Screw Schraube	Tork Anahtar Torx Key Torx-Schlüssel	Montaj Vidası Mounting Screw Befestigungsschraube	
AFMR-RP1204M-D050-A22-Z04-H	●	50	4	22	50	6	RPMT 1204..	4015-M4x11	80-T15	2508-M10x30	
AFMR-RP1204M-D052-A22-Z05-H	●	52	5	22	50	6				2510-M12x35	
AFMR-RP1204M-D063-A22-Z05-H	●	63	5	22	50	6					
AFMR-RP1204M-D080-A27-Z06-H	●	80	6	27	50	6					

R: Sağ / Right / Rechts L: Sol/Left/Links

● Stokta / In Stock / Auf Lager ○ Stokta Yok / Non Stock Item / Kein Lagerartikel, Lieferzeit auf Anfrage
MTSBH Ucuna Uygunudur. / Compatible with MTSBH Insert. Kompatibel mit MTSBH Wendeplatten.

Sipariş Örneği/Ordering Example/Bestellbeispiel

1 ad./pcs./stück AFMR-RP10T3-D063-A22-Z06-H

Kesme Hesabı : S 331 / Cutting Calculation : P 331 / Schnittberechnung : 331

Montaj Ölçüleri : S 328 / Mounting Reference : P 328 / Montagehinweis : 328

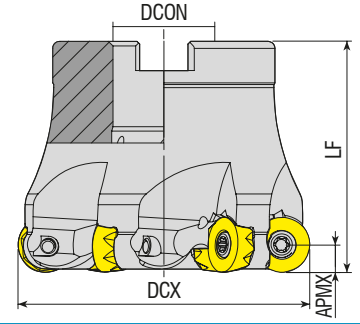

Yedek Parçaları / Spare Parts / Ersatzteile

Takım Kodu Ordering Code Bestell-Bezeichnung	Stok Stock Lager	Takım Ölçüleri (mm) Dimension (mm) Abmessung (mm)					Kesici Uç Insert Wendeschneidplatte	Sıkma Vidası Screw Schraube	Tork Anahtar Torx Key Torx-Schlüssel	Montaj Vidası Mounting Screw Befestigungsschraube
		DCX	ZEFP	DCON	LF	APMX				
AFMR-RY10-D040-A16-Z04-H	●	40	4	16	40	5	RYMX 1004..	4015-M3.5x11	80-T15	2406-M8x30
AFMR-RY10-D040-A16-Z05-H	●	40	5	16	40	5				2506-M8x30
AFMR-RY10-D050-A22-Z05-H	●	50	5	22	50	5				2508-M10x30
AFMR-RY10-D063-A22-Z06-H	●	63	6	22	50	5				2406-M8x30
AFMR-RY12-D040-A16-Z04-H	●	40	4	16	40	6	RYMX 1205..	4015-M4x11	80-T15	2406-M8x30
AFMR-RY12-D050-A22-Z05-H	●	50	5	22	50	6				2508-M10x30
AFMR-RY12-D052-A22-Z05-H	●	52	5	22	50	6				2510-M12x35
AFMR-RY12-D063-A22-Z06-H	●	63	6	22	50	6				2514-M16x35
AFMR-RY12-D080-A27-Z06-H	●	80	6	27	50	6				
AFMR-RY12-D100-A32-Z07-H	●	100	7	32	50	6				

TGTC Ucuna Uygunur. / Compatiple with TGTC Insert. Kompatibel mit TGTC Wendeplatten.

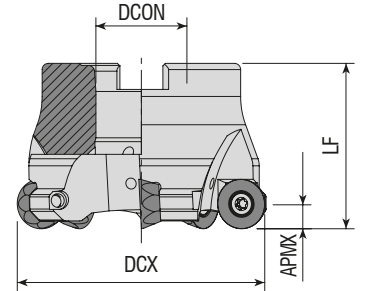

Yedek Parçaları / Spare Parts / Ersatzteile

Takım Kodu Ordering Code Bestell-Bezeichnung	Stok Stock Lager	Takım Ölçüleri (mm) Dimension (mm) Abmessung (mm)					Kesici Uç Insert Wendeschneidplatte	Sıkma Vidası Screw Schraube	Tork Anahtar Torx Key Torx-Schlüssel	Montaj Vidası Mounting Screw Befestigungsschraube
		DCX	ZEFP	DCON	LF	APMX				
AFMR-QP10T3-D040-A16-Z04-H	●	40	4	16	40	5	QP. 10T3..	4015-M3.5x11	80-T15	2506-M8x30
AFMR-QP10T3-D050-A22-Z05-H	●	50	5	22	40	5				2407-M10x30
AFMR-QP10T3-D063-A22-Z06-H	●	63	6	22	40	5				
AFMR-QP1204-D050-A22-Z04-H	●	50	4	22	40	6	QP. 1204..	4015-M4x11	80-T15	
AFMR-QP1204-D063-A22-Z05-H	●	63	5	22	40	6				

R: Sağ / Right / Rechts L: Sol/Left/Links

● Stokta / In Stock / Auf Lager ○ Stokta Yok / Non Stock Item / Kein Lagerartikel, Lieferzeit auf Anfrage
SMTM Ucuna Uygunur. / Compatiple with SMTM Insert. Kompatibel mit SMTM Wendeplatten.

Sipariş Örneği/Ordering Example/Bestellbeispiel

1 ad./pcs./stück AFMR-RY10-D040-A16-Z04-H

Kesme Hesabı : S 331 / Cutting Calculation : P 331 / Schnittberechnung : 331

Montaj Ölçüleri : S 328 / Mounting Reference : P 328 / Montagehinweis : 328

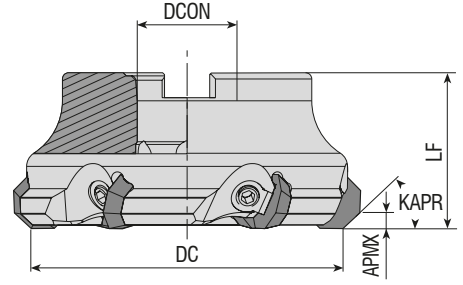

Takım Kodu Ordering Code Bestell-Bezeichnung	Stok Stock Lager	Takım Ölçüleri (mm) Dimension (mm) Abmessung (mm)					Kesici Uç Insert Wendeschneidplatte	Yedek Parçaları / Spare Parts / Ersatzteile				
		DC	ZEFP	DCON	LF	APMX		Baskı Parçası Wedge Clamp Spannpratze	Baskı Vidası Clamp Screw Klemmschraube	Anahtar Allen Key Innensechskantschlüssel	Montaj Vidası Mounting Screw Befestigungsschraube	
AFM43C-OF07-D063-A22-Z04	●	63	4	22	45	5	OF. 0704..	ACK-11	AKV-15-M8x1x20	AAL-05-4	2508-M10x30	
AFM43C-OF07-D080-A27-Z05	●	80	5	27	50	5					2510-M12x35	
AFM43C-OF07-D100-A32-Z06	●	100	6	32	50	5					2514-M16x35	
AFM43C-OF07-D125-B40-Z08	●	125	8	40	63	5					-	
AFM43C-OF07-D160-C40-Z09	●	160	9	40	63	5					-	

ISO Ucuna Uygundur. / Compatible with ISO Insert. Kompatibel mit ISO Wendeplatten.

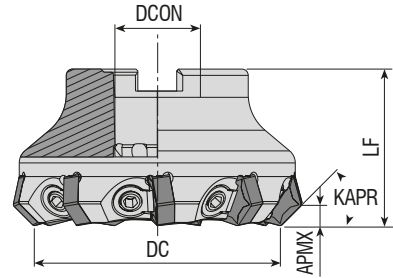

Takım Kodu Ordering Code Bestell-Bezeichnung	Stok Stock Lager	Takım Ölçüleri (mm) Dimension (mm) Abmessung (mm)					Kesici Uç Insert Wendeschneidplatte	Yedek Parçaları / Spare Parts / Ersatzteile				
		DC	ZEFP	DCON	LF	APMX		Baskı Parçası Wedge Clamp Spannpratze	Baskı Vidası Clamp Screw Klemmschraube	Anahtar Allen Key Innensechskantschlüssel	Montaj Vidası Mounting Screw Befestigungsschraube	
AFM45C-HN0905-D063-A22-Z07	●	63	7	22	40	4.5	HN.. 0905..	ACK-11	AKV-15-M8x1x20	AAL-05-4	2508-M10x30	
AFM45C-HN0905-D080-A27-Z09	●	80	9	27	50	4.5					2510-M12x35	
AFM45C-HN0905-D100-A32-Z11	●	100	11	32	50	4.5					2514-M16x35	
AFM45C-HN0905-D125-B40-Z13	●	125	13	40	63	4.5					-	
AFM45C-HN0905-D125-B40-Z10	●	125	10	40	63	4.5					-	
AFM45C-HN0905-D160-C40-Z15	●	160	15	40	63	4.5					-	

R: Sağ / Right / Rechts L: Sol/Left/Links

● Stokta / In Stock / Auf Lager ○ Stokta Yok / Non Stock Item / Kein Lagerartikel, Lieferzeit auf Anfrage

WDA-KNMTL Ucuna Uygundur. / Compatible with WDA-KNMTL Insert. Kompatibel mit WDA-KNMTL Wendeplatten.

Sipariş Örneği/Ordering Example/Bestellbeispiel

1 ad./pcs./stück AFM43C-OF07-D063-A22-Z04

Kesme Hesabı : S 331 / Cutting Calculation : P 331 / Schnittberechnung : 331

Montaj Ölçüleri : S 328 / Mounting Reference : P 328 / Montagehinweis : 328

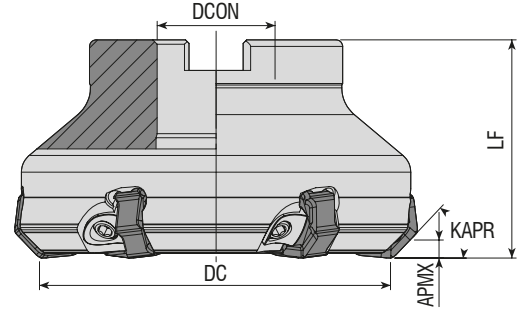

Takım Kodu Ordering Code Bestell-Bezeichnung	Stok Stock Lager	Takım Ölçüleri (mm) Dimension (mm) Abmessung (mm)					Kesici Uç Insert Wendeschneidplatte	Yedek Parçaları / Spare Parts / Ersatzteile				
		DC	ZEPF	DCON	LF	APMX		Baskı Parçası Wedge Clamp Spannpratze	Baskı Vidası Clamp Screw Klemmschraube	Anahtar Allen Key Innensechskantschlüssel	Montaj Vidası Mounting Screw Befestigungsschraube	
AFM45C-XN0806-D063-A22-Z05	●	63	5	22	50	4.5	XNMU 0806..	ACK-26	AKV-26-M6x0.75x20	AAL-03-03	2508-M10x30	
AFM45C-XN0806-D080-A27-Z06	●	80	6	27	50	4.5					2510-M12x35	
AFM45C-XN0806-D100-A32-Z08	●	100	8	32	50	4.5					2514-M16x35	
AFM45C-XN0806-D125-B40-Z08	●	125	8	40	63	4.5					-	
AFM45C-XN0806-D160-C40-Z10	●	160	10	40	63	4.5					-	
AFM45C-XN0806-D200-C60-Z12	●	200	12	60	63	4.5					-	

DJT Ucuna Uygun. / Compatible with DJT Insert. Kompatibel mit DJT Wendepfatten.

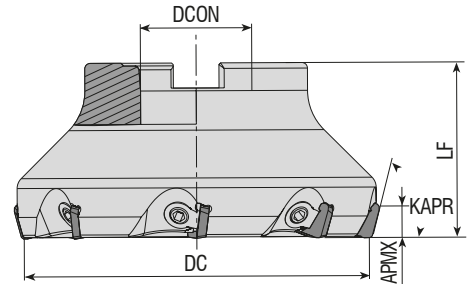

Takım Kodu Ordering Code Bestell-Bezeichnung	Stok Stock Lager	Takım Ölçüleri (mm) Dimension (mm) Abmessung (mm)					Kesici Uç Insert Wendeschneidplatte	Yedek Parçaları / Spare Parts / Ersatzteile				
		DC	ZEPF	DCON	LF	APMX		Baskı Parçası Wedge Clamp Spannpratze	Baskı Vidası Clamp Screw Klemmschraube	Anahtar Allen Key Innensechskantschlüssel	Montaj Vidası Mounting Screw Befestigungsschraube	
AFM75C-SP12-D050-A22-Z04	●	50	4	22	42	8	SPKN 1203..	ACK-10	AKV-22-M8x1x14	AAL-05-4	2508-M10x30	
AFM75C-SP12-D063-A22-Z05	●	63	5	22	40	8					2510-M12x35	
AFM75C-SP12-D080-A27-Z06	●	80	6	27	50	8					2514-M16x35	
AFM75C-SP12-D100-A32-Z07	●	100	7	32	50	8					-	
AFM75C-SP12-D125-B40-Z08	●	125	8	40	63	8					-	
AFM75C-SP12-D160-C40-Z09	●	160	9	40	63	8					-	
AFM75C-SP12-D200-C60-Z12	●	200	12	60	63	8	-					

R: Sağ / Right / Rechts L: Sol/Left/Links
● Stokta / In Stock / Auf Lager ○ Stokta Yok / Non Stock Item / Kein Lagerartikel, Lieferzeit auf Anfrage
ISO Ucuna Uygun. / Compatible with ISO Insert. Kompatibel mit ISO Wendepfatten.

Sipariş Örneği/Ordering Example/Bestellbeispiel
1 ad./pcs./stück AFM45C-XN0806-D063-A22-Z05

Kesme Hesabı : S 331 / Cutting Calculation : P 331 / Schnittberechnung : 331
Montaj Ölçüleri : S 328 / Mounting Reference : P 328 / Montagehinweis : 328



KAPR=88°

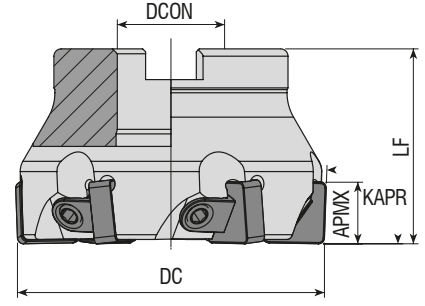

Takım Kodu Ordering Code Bestell-Bezeichnung	Stok Stock Lager	Takım Ölçüleri (mm) Dimension (mm) Abmessung (mm)					Kesici Uç Insert Wendeschneidplatte	Yedek Parçaları / Spare Parts / Ersatzteile			
		DC	ZEFP	DCON	LF	APMX		Baskı Parçası Wedge Clamp Spannpratze	Baskı Vidası Clamp Screw Klemmschraube	Anahtar Allen Key Innensechskantschlüssel	Montaj Vidası Mounting Screw Befestigungsschraube
AFM88C-SN1204-D050-A22-Z05	●	50	5	22	40	11	SN.. 1204..	ACK-21	AKV-24-M6x1x1	AAL-03-3	2408-M10x30
AFM88C-SN1204-D063-A22-Z06	●	63	6	22	40	11					
AFM88C-SN1204-D080-A27-Z07	●	80	7	27	50	11					
AFM88C-SN1204-D100-A32-Z08	●	100	8	32	50	11					
AFM88C-SN1204-D125-B40-Z11	●	125	11	40	63	11					

UNIN-NT.-KYCR Ucuna Uygun. / Compatible with UNIN-NT.-KYCR Insert. Kompatibel mit UNIN-NT.-KYCR Wendeplatten.

KAPR=90°

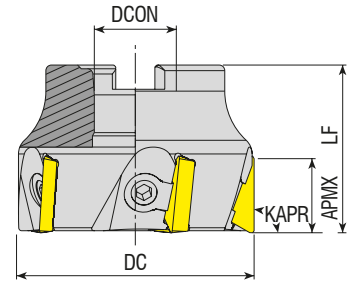

Takım Kodu Ordering Code Bestell-Bezeichnung	Stok Stock Lager	Takım Ölçüleri (mm) Dimension (mm) Abmessung (mm)					Kesici Uç Insert Wendeschneidplatte	Yedek Parçaları / Spare Parts / Ersatzteile			
		DC	ZEFP	DCON	LF	APMX		Baskı Parçası Wedge Clamp Spannpratze	Baskı Vidası Clamp Screw Klemmschraube	Anahtar Allen Key Innensechskantschlüssel	Montaj Vidası Mounting Screw Befestigungsschraube
AFM90C-TP16-D050-A22-Z04	●	50	4	22	40	12	TP. 1603..	ACK-10	AKV-22-M8x1x14 AKV-13-M8x1x16	AAL-05-4	2407-M10x30
AFM90C-TP16-D063-A22-Z06	●	63	6	22	45	12					2508-M10x30
AFM90C-TP16-D080-A27-Z07	●	80	7	27	50	12					2510-M12x35
AFM90C-TP16-D100-A32-Z08	●	100	8	32	50	12					2514-M16x35
AFM90C-TP16-D125-B40-Z08	●	125	8	40	63	12					-
AFM90C-TP22-D063-A22-Z05	●	63	5	22	45	18	TP. 2204..	ACK-11	AKV-14-M8x1x18	AAL-05-4	2508-M10x30
AFM90C-TP22-D080-A27-Z06	●	80	6	27	50	18					2510-M12x35
AFM90C-TP22-D100-A32-Z07	●	100	7	32	50	18					2514-M16x35
AFM90C-TP22-D125-B40-Z08	●	125	8	40	63	18					-
AFM90C-TP22-D160-C40-Z09	●	160	9	40	63	18					-
AFM90C-TP22-D200-C60-Z12	●	200	12	60	63	18					-
AFM90C-TP22-D250-C60-Z15	●	250	15	60	63	18					-
AFM90C-TP22-D315-D60-Z18	●	315	18	60	63	18	-				

R: Sağ / Right / Rechts L: Sol/Left/Links

● Stokta / In Stock / Auf Lager ○ Stokta Yok / Non Stock Item / Kein Lagerartikel, Lieferzeit auf Anfrage

ISO Ucuna Uygun. / Compatible with ISO Insert. Kompatibel mit ISO Wendeplatten.

Sipariş Örneği/Ordering Example/Bestellbeispiel

1 ad./pcs./stück AFM88C-SN1204-D040-A16-Z04

Kesme Hesabı : S 331 / Cutting Calculation : P 331 / Schnittberechnung : 331

Montaj Ölçüleri : S 328 / Mounting Reference : P 328 / Montagehinweis : 328

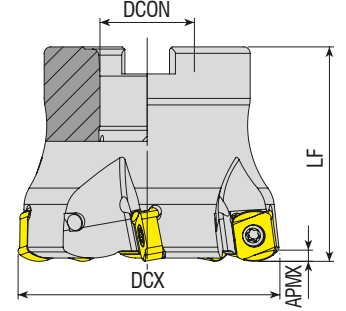

Takım Kodu Ordering Code Bestell-Bezeichnung	Stok Stock Lager	Takım Ölçüleri (mm) Dimension (mm) Abmessung (mm)					Kesici Uç Insert Wendeschneidplatte	Yedek Parçaları / Spare Parts / Ersatzteile		
		DCX	ZEFP	DCON	LF	APMX		Sıkma Vidası Screw Schraube	Tork Anahtar Torx Key Torx-Schlüssel	Montaj Vidası Mounting Screw Befestigungsschraube
AHFM-BL0603-D040-A16-Z06-H	●	40	6	16	40	1	BLMP 0603..	3008-M2.5x6	80-T08	2506-M8x30
AHFM-BL0603-D050-A22-Z07-H	●	50	7	22	40	1				
AHFM-BL0904-D040-A16-Z05-H	●	40	5	16	40	2	BLMP 0904..	3010-M3.5x9	80-T10	2508-M10x30
AHFM-BL0904-D050-A22-Z06-H	●	50	6	22	50	2				
AHFM-BL0904-D063-A22-Z05-H	●	63	5	22	50	2				
AHFM-BL0904-D063-A22-Z07-H	●	63	7	22	50	2				

TGTC Ucuna Uygundur. / Compatible with TGTC Insert. Kompatibel mit TGTC Wendeplatten.

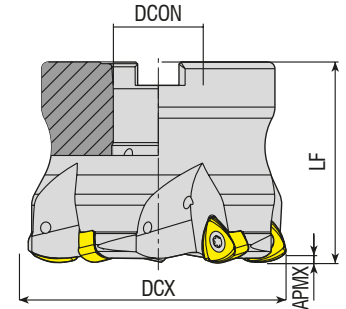

Takım Kodu Ordering Code Bestell-Bezeichnung	Stok Stock Lager	Takım Ölçüleri (mm) Dimension (mm) Abmessung (mm)					Kesici Uç Insert Wendeschneidplatte	Yedek Parçaları / Spare Parts / Ersatzteile		
		DCX	ZEFP	DCON	LF	APMX		Sıkma Vidası Screw Schraube	Tork Anahtar Torx Key Torx-Schlüssel	Montaj Vidası Mounting Screw Befestigungsschraube
AHFM-BL1205-D050-A22-Z03-H	●	50	3	22	40	2	BLMP 1205..	4015-M4x11	80-T15	2508-M10x30
AHFM-BL1205-D063-A22-Z04-H	●	63	4	22	40	2				2510-M12x35
AHFM-BL1205-D080-A27-Z05-H	●	80	5	27	50	2				

R: Sağ / Right / Rechts L: Sol/Left/Links

● Stokta / In Stock / Auf Lager ○ Stokta Yok / Non Stock Item / Kein Lagerartikel, Lieferzeit auf Anfrage
TGTC Ucuna Uygundur. / Compatible with TGTC Insert. Kompatibel mit TGTC Wendeplatten.

Sipariş Örneği/Ordering Example/Bestellbeispiel

1 ad./pcs./stück AHFM-BL0603-D040-A16-Z06-H

Kesme Hesabı : S 331 / Cutting Calculation : P 331 / Schnittberechnung : 331

Montaj Ölçüleri : S 328 / Mounting Reference : P 328 / Montagehinweis : 328

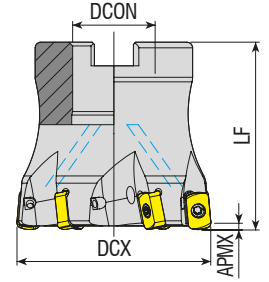

Takım Kodu Ordering Code Bestell-Bezeichnung	Stok Stock Lager	Takım Ölçüleri (mm) Dimension (mm) Abmessung (mm)					Kesici Uç Insert Wendeschneidplatte	Yedek Parçaları / Spare Parts / Ersatzteile		
		DCX	ZFP	DCON	LF	APMX		Sıkma Vidası Screw Schraube	Tork Anahtar Torx Key Torx-Schlüssel	Montaj Vidası Mounting Screw Befestigungsschraube
AHFM-EN1004-D050-A22-Z05-H	●	50	5	22	50	1	ENMU 1004..	3008-M2.5X6	80-T08	2508-M10x30
AHFM-EN1004-D050-A22-Z06-H	●	50	6	22	50	1				
AHFM-EN1004-D052-A22-Z06-H	●	52	6	22	50	1				
AHFM-EN1004-D063-A22-Z06-H	●	63	6	22	50	1				

DJT Ucuna Uygunur. / Compatiple with DJT Insert. Kompatibel mit DJT Wendeplatten.

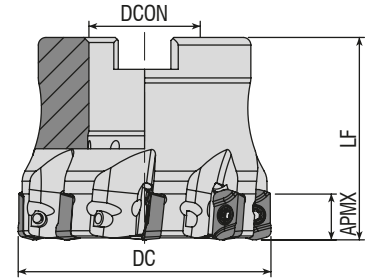

Takım Kodu Ordering Code Bestell-Bezeichnung	Stok Stock Lager	Takım Ölçüleri (mm) Dimension (mm) Abmessung (mm)					Kesici Uç Insert Wendeschneidplatte	Yedek Parçaları / Spare Parts / Ersatzteile		
		DC	ZFP	DCON	LF	APMX		Sıkma Vidası Screw Schraube	Tork Anahtar Torx Key Torx-Schlüssel	Montaj Vidası Mounting Screw Befestigungsschraube
AHFM-EP1003-D050-A22-Z08-H	●	50	8	22	40	1	EP. 1003.. ZPMT 1003.. YPHW 1003..	3008-M2.5X6	80-T08	2508-M10x30
AHFM-EP1003-D063-A22-Z08-H	●	63	8	22	40	1				

R: Sağ / Right / Rechts L: Sol/Left/Links

● Stokta / In Stock / Auf Lager ○ Stokta Yok / Non Stock Item / Kein Lagerartikel, Lieferzeit auf Anfrage

DJT Ucuna Uygunur. / Compatiple with DJT Insert. Kompatibel mit DJT Wendeplatten.

Sipariş Örneği/Ordering Example/Bestellbeispiel

1 ad./pcs./stück AHFM-EN1004-D050-A22-Z05-H

Kesme Hesabı : S 331 / Cutting Calculation : P 331 / Schnittberechnung : 331

Montaj Ölçüleri : S 328 / Mounting Reference : P 328 / Montagehinweis : 328

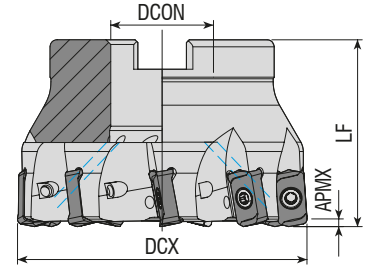

Takım Kodu Ordering Code Bestell-Bezeichnung	Stok Stock Lager	Takım Ölçüleri (mm) Dimension (mm) Abmessung (mm)					Kesici Uç Insert Wendeschneidplatte	Yedek Parçaları / Spare Parts / Ersatzteile			
		DCX	ZEFP	DCON	LF	APMX		Sıkma Vidası Screw Schraube	Tork Anahtar Torx Key Torx-Schlüssel	Montaj Vidası Mounting Screw Befestigungsschraube	
AHFM-L003-D040-A16-Z06-H	●	40	6	16	40	1	LOGU 0303..		80-T08	2506-M8x30	
AHFM-L003-D050-A22-Z07-H	●	50	7	22	40	1				1108-M3x6.8	2508-M10x30
AHFM-L003-D063-A22-Z09-H	●	63	9	22	40	1					

KYCR Ucuna Uygunur. / Compatiple with KYCR Insert. Kompatibel mit KYCR Wendeplatten.

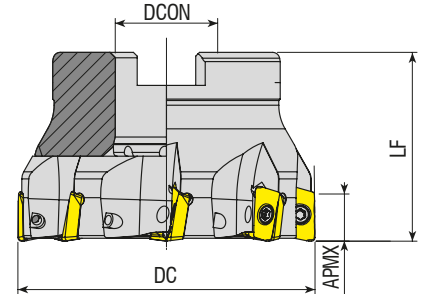

Takım Kodu Ordering Code Bestell-Bezeichnung	Stok Stock Lager	Takım Ölçüleri (mm) Dimension (mm) Abmessung (mm)					Kesici Uç Insert Wendeschneidplatte	Yedek Parçaları / Spare Parts / Ersatzteile		
		DC	ZEFP	DCON	LF	APMX		Sıkma Vidası Screw Schraube	Tork Anahtar Torx Key Torx-Schlüssel	Montaj Vidası Mounting Screw Befestigungsschraube
AHFM-JD1003-D040-A16-Z06-H	●	40	6	16	40	9	JDMT 1003..		80-T08	2506-M8x30
AHFM-JD1003-D063-A22-Z08-H	●	63	8	22	40	9				3008-M2.5x6

R: Sağ / Right / Rechts L: Sol/Left/Links

● Stokta / In Stock / Auf Lager ○ Stokta Yok / Non Stock Item / Kein Lagerartikel, Lieferzeit auf Anfrage
MTSBH Ucuna Uygunur. / Compatiple with MTSBH Insert. Kompatibel mit MTSBH Wendeplatten.

Sipariş Örneği/Ordering Example/ Bestellbeispiel

1 ad./pcs./stück AHFM-L003-D040-A16-Z06-H

Kesme Hesabı : S 331 / Cutting Calculation : P 331 / Schnittberechnung : 331

Montaj Ölçüleri : S 328 / Mounting Reference : P 328 / Montagehinweis : 328

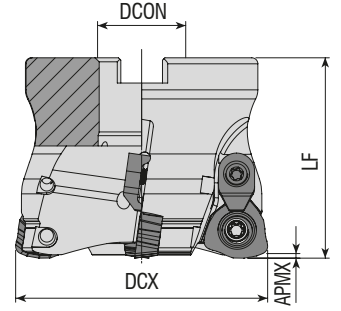

Takım Kodu Ordering Code Bestell-Bezeichnung	Stok Stock Lager	Takım Ölçüleri (mm) Dimension (mm) Abmessung (mm)					Kesici Uç Insert Wendeschneidplatte	Yedek Parçaları / Spare Parts / Ersatzteile					
		DCX	ZEFP	DCON	LF	APMX		Sıkma Vidası Screw Schraube	Baskı Pabucu Wedge Clamp Spannpratze	Baskı Vidası Clamp Screw Klemmschraube	Tork Anahtar Torx Key Torx-Schlüssel	Montaj Vidası Mounting Screw Befestigungsschraube	
AHFMC-JD1204-D052-A22-Z03-H	●	52	3	22	50	1.5	JDMW 1204..	4615-M4x11	ACK-05	4015-M4x11	80-T15	2508-M10x30	
AHFMC-JD1204-D052-A22-Z04-H	●	52	4	22	50	1.5							
AHFMC-JD1204-D063-A22-Z05-H	●	63	5	22	50	1.5							
AHFMC-JD1204-D080-A27-Z06-H	●	80	6	27	50	1.5							
AHFMC-JD1204-D100-A32-Z07-H	●	100	7	32	50	1.5							
AHFMC-JD1405-D052-A22-Z03-H	●	52	3	22	40	2	JDMW 1405..	1020-M5x11		80-T20	2408-M10x30		
AHFMC-JD1405-D063-A22-Z04-H	●	63	4	22	40	2					2508-M10x30		

MTSBH Ucuna Uygunur. / Compatiple with MTSBH Insert. Kompatibel mit MTSBH Wendeplatten.

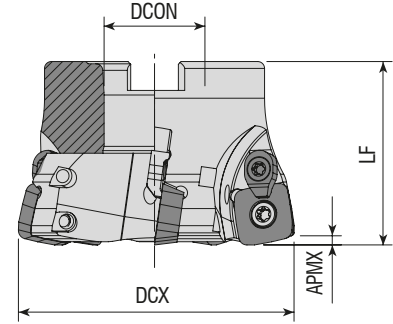
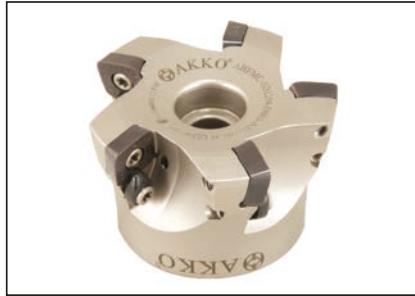

Takım Kodu Ordering Code Bestell-Bezeichnung	Stok Stock Lager	Takım Ölçüleri (mm) Dimension (mm) Abmessung (mm)					Kesici Uç Insert Wendeschneidplatte	Yedek Parçaları / Spare Parts / Ersatzteile					
		DCX	ZEFP	DCON	LF	APMX		Sıkma Vidası Screw Schraube	Baskı Pabucu Wedge Clamp Spannpratze	Baskı Vidası Clamp Screw Klemmschraube	Tork Anahtar Torx Key Torx-Schlüssel	Montaj Vidası Mounting Screw Befestigungsschraube	
AHFMC-SD1204-D050-A22-Z04-H	●	50	4	22	40	1.8	SD.. 1204..	4015-M4x11	ACK-15	4015-M3.5x11	80-T15	2508-M10x30	
AHFMC-SD1204-D063-A22-Z05-H	●	63	5	22	40	1.8							
AHFMC-SD1204-D080-A27-Z06-H	●	80	6	27	50	1.8							
AHFMC-SD1204-D100-A32-Z08-H	●	100	8	32	50	1.8							

R: Sağ / Right / Rechts L: Sol/Left/Links

● Stokta / In Stock / Auf Lager ○ Stokta Yok / Non Stock Item / Kein Lagerartikel, Lieferzeit auf Anfrage
ZCC Ucuna Uygunur. / Compatiple with ZCC Insert. Kompatibel mit ZCC Wendeplatten.

Sipariş Örneği/Ordering Example/Bestellbeispiel

1 ad./pcs./stück AHFMC-JD1204-D052-A22-Z03-H

Kesme Hesabı : S 331 / Cutting Calculation : P 331 / Schnittberechnung : 331

Montaj Ölçüleri : S 328 / Mounting Reference : P 328 / Montagehinweis : 328

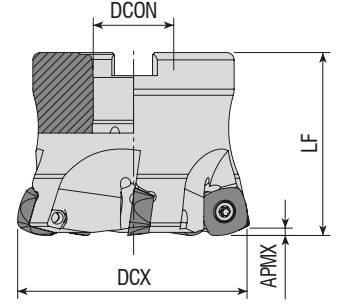

Takım Kodu Ordering Code Bestell-Bezeichnung	Stok Stock Lager	Takım Ölçüleri (mm) Dimension (mm) Abmessung (mm)					Kesici Uç Insert Wendeschneidplatte	Yedek Parçaları / Spare Parts / Ersatzteile		
		DCX	ZEFP	DCON	LF	APMX		Sıkma Vidası Screw Schraube	Tork Anahtar Torx Key Torx-Schlüssel	Montaj Vidası Mounting Screw Befestigungsschraube
AHFM-SD1205-D052-A22-Z04-H	●	52	4	22	50	2	SD.. 1205..			2508-M10x30
AHFM-SD1205-D052-A22-Z05-H	●	52	5	22	50	2				
AHFM-SD1205-D066-A22-Z05-H	●	66	5	22	50	2				
AHFM-SD1205-D066-A22-Z06-H	●	66	6	22	50	2				
AHFM-SD1205-D080-A27-Z06-H	●	80	6	27	70	2				2510-M12x35

HTCH Ucuna Uygundur. / Compatiple with HTCH Insert. Kompatibel mit HTCH Wendeplatten.

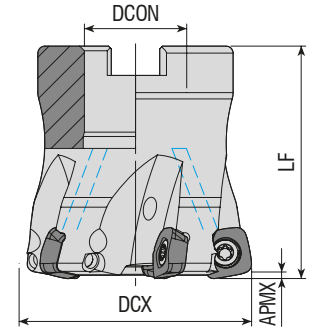

Takım Kodu Ordering Code Bestell-Bezeichnung	Stok Stock Lager	Takım Ölçüleri (mm) Dimension (mm) Abmessung (mm)					Kesici Uç Insert Wendeschneidplatte	Yedek Parçaları / Spare Parts / Ersatzteile		
		DCX	ZEFP	DCON	LF	APMX		Sıkma Vidası Screw Schraube	Tork Anahtar Torx Key Torx-Schlüssel	Montaj Vidası Mounting Screw Befestigungsschraube
AHFM-SO1004-D050-A22-Z05-H	●	50	5	22	50	1.5	SOMT 1004..			2508-M10x30
AHFM-SO1004-D063-A22-Z06-H	●	63	6	22	50	1.5				
AHFM-SO1004-D080-A27-Z07-H	●	80	7	27	63	1.5				2510-M12x35

R: Sağ / Right / Rechts L: Sol/Left/Links

● Stokta / In Stock / Auf Lager ○ Stokta Yok / Non Stock Item / Kein Lagerartikel, Lieferzeit auf Anfrage
KYCR Ucuna Uygundur. / Compatiple with KYCR Insert. Kompatibel mit KYCR Wendeplatten.

Sipariş Örneği/Ordering Example/Bestellbeispiel

1 ad./pcs./stück AHFM-SD1205-D052-A22-Z04-H

Kesme Hesabı : S 331 / Cutting Calculation : P 331 / Schnittberechnung : 331

Montaj Ölçüleri : S 328 / Mounting Reference : P 328 / Montagehinweis : 328

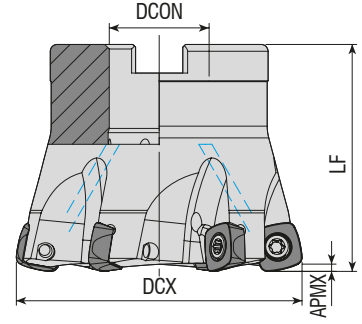

Takım Kodu Ordering Code Bestell-Bezeichnung	Stok Stock Lager	Takım Ölçüleri (mm) Dimension (mm) Abmessung (mm)					Kesici Uç Insert Wendeschneidplatte	Yedek Parçaları / Spare Parts / Ersatzteile			
		DCX	ZEFP	DCON	LF	APMX		Sıkma Vidası Screw Schraube	Tork Anahtar Torx Key Torx-Schlüssel	Montaj Vidası Mounting Screw Befestigungsschraube	
AHFM-SP1004-D050-A22-Z05-H	●	50	5	22	50	1.5	SPNW 1004..			2508-M10x30	
AHFM-SP1004-D052-A22-Z05-H	●	52	5	22	50	1.5					
AHFM-SP1004-D063-A22-Z06-H	●	63	6	22	50	1.5					

R: Sağ / Right / Rechts L: Sol/Left/Links

● Stokta / In Stock / Auf Lager ○ Stokta Yok / Non Stock Item / Kein Lagerartikel, Lieferzeit auf Anfrage
DJT Ucuna Uygundur. / Compatible with DJT Insert. Kompatibel mit DJT Wendepalten.

Sipariş Örneği/Ordering Example/Bestellbeispiel

1 ad./pcs./stück AHFM-SP1004-D050-A22-Z05-H

Kesme Hesabı : S 331 / Cutting Calculation : P 331 / Schnittberechnung : 331

Montaj Ölçüleri : S 328 / Mounting Reference : P 328 / Montagehinweis : 328



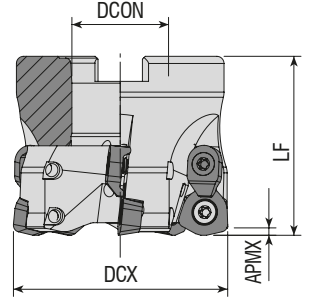

Takım Kodu Ordering Code Bestell-Bezeichnung	Stok Stock Lager	Takım Ölçüleri (mm) Dimension (mm) Abmessung (mm)					Kesici Uç Insert Wendeschneidplatte	Yedek Parçaları / Spare Parts / Ersatzteile				
		DCX	ZEFP	DCON	LF	APMX		Sıkma Vidası Screw Schraube	Baskı Pabucu Wedge Clamp Spannpratze	Baskı Vidası Clamp Screw Klemmschraube	Tork Anahtar Torx Key Torx-Schlüssel	Montaj Vidası Mounting Screw Befestigungsschraube
AHFMC-WD06T3D-D042-A16-Z04-H	●	42	4	16	45	1.5	WD.W 06T3..	3015-M3.5x9	ACK-15	4015-M3.5x11	80-T15	2506-M8x30
AHFMC-WD06T3D-D050-A22-Z05-H	●	50	5	22	50	1.5						
AHFMC-WD06T3D-D052-A22-Z05-H	●	52	5	22	50	1.5						
AHFMC-WD0805D-D052-A22-Z04-H	●	52	4	22	50	2	WD.W 0805..	4020-M4.5x12	ACK-19	4020-M4.5x12	80-T20	2508-M10x30
AHFMC-WD0805D-D063-A22-Z05-H	●	63	5	22	50	2						
AHFMC-WD0805D-D063-A27-Z05-H	●	63	5	27	50	2						
AHFMC-WD0805D-D066-A27-Z05-H	●	66	5	27	50	2						
AHFMC-WD0805D-D080-A27-Z05	●	80	5	27	50	2						
AHFMC-WD0805D-D100-A32-Z06	●	100	6	32	50	2						
AHFMC-WD10X6D-D125-B40-Z06	●	125	6	40	63	2.5	WD.W 10X6..					2514-M16x35
AHFMC-WD10X6D-D160-C40-Z07	●	160	7	40	63	2.5						

DJT Ucuna Uygun. / Compatible with DJT Insert. Kompatibel mit DJT Wendeplatten.

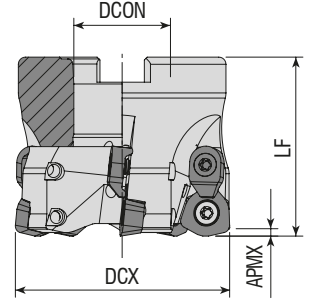

Takım Kodu Ordering Code Bestell-Bezeichnung	Stok Stock Lager	Takım Ölçüleri (mm) Dimension (mm) Abmessung (mm)					Kesici Uç Insert Wendeschneidplatte	Yedek Parçaları / Spare Parts / Ersatzteile				
		DCX	ZEFP	DCON	LF	APMX		Sıkma Vidası Screw Schraube	Baskı Pabucu Wedge Clamp Spannpratze	Baskı Vidası Clamp Screw Klemmschraube	Tork Anahtar Torx Key Torx-Schlüssel	Montaj Vidası Mounting Screw Befestigungsschraube
AHFMC-WD0804-D040-A16-Z04-H	●	40	4	16	40	1.5	WDMT 0804..	4010-M3x8	ACK-15	4010-M3x8	80-T10	2506-M8x30
AHFMC-WD0804-D050-A22-Z04-H	●	50	4	22	50	1.5						
AHFMC-WD1205-D050-A22-Z04-H	●	50	4	22	50	3	WDMT 1205..	1415-M4x11	ACK-05	4015-M4x11	80-T15	2508-M10x30
AHFMC-WD1205-D052-A22-Z04-H	●	52	4	22	50	3						
AHFMC-WD1205-D063-A22-Z05-H	●	63	5	22	50	3						
AHFMC-WD1205-D080-A27-Z06-H	●	80	6	27	63	3						

R: Sağ / Right / Rechts L: Sol/Left/Links

● Stokta / In Stock / Auf Lager ○ Stokta Yok / Non Stock Item / Kein Lagerartikel, Lieferzeit auf Anfrage

SMTM Ucuna Uygun. / Compatible with SMTM Insert. Kompatibel mit SMTM Wendeplatten.

Sipariş Örneği/Ordering Example/Bestellbeispiel

1 ad./pcs./stück AHFMC-WD06T3D-D042-A16-Z04-H

Kesme Hesabı : S 331 / Cutting Calculation : P 331 / Schnittberechnung : 331

Montaj Ölçüleri : S 328 / Mounting Reference : P 328 / Montagehinweis : 328

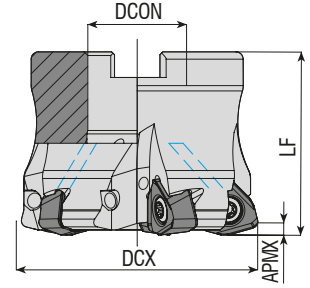

Takım Kodu Ordering Code Bestell-Bezeichnung	Stok Stock Lager	Takım Ölçüleri (mm) Dimension (mm) Abmessung (mm)					Kesici Uç Insert Wendeschneidplatte	Yedek Parçaları / Spare Parts / Ersatzteile		
		DCX	ZEFP	DCON	LF	APMX		Sıkma Vidası Screw Schraube	Tork Anahtar Torx Key Torx-Schlüssel	Montaj Vidası Mounting Screw Befestigungsschraube
AHFM-WN0907-D050-A22-Z04-H	●	50	4	22	50	3	WNMU 0907..	1020-M5x14	80-T20	2508-M10x30
AHFM-WN0907-D052-A22-Z04-H	●	52	4	22	50	3				
AHFM-WN0907-D063-A22-Z05-H	●	63	5	22	50	3				
AHFM-WN0907-D066-A27-Z05-H	●	66	5	27	50	3				
AHFM-WN0907-D080-A27-Z06-H	●	80	6	27	50	3				2510-M12x35
AHFM-WN0907-D100-A32-Z07-H	●	100	7	32	50	3				2514-M16x35

DJT Ucuna Uygundur. / Compatible with DJT Insert. Kompatibel mit DJT Wendeplatten.

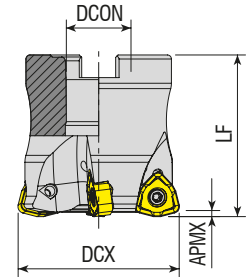

Takım Kodu Ordering Code Bestell-Bezeichnung	Stok Stock Lager	Takım Ölçüleri (mm) Dimension (mm) Abmessung (mm)					Kesici Uç Insert Wendeschneidplatte	Yedek Parçaları / Spare Parts / Ersatzteile		
		DCX	ZEFP	DCON	LF	APMX		Sıkma Vidası Screw Schraube	Tork Anahtar Torx Key Torx-Schlüssel	Montaj Vidası Mounting Screw Befestigungsschraube
AHFM-WN09T3-D040-A16-Z04-H	●	40	4	16	40	1.5	WNMX 09T3..	4010-M3x8	80-T10	2506-M8x30
AHFML-WN09T3-D040-A16-Z04-H	●	40	4	16	40	1.5				
AHFM-WN09T3-D050-A22-Z05-H	●	50	5	22	40	1.5				
AHFML-WN09T3-D050-A22-Z05-H	●	50	5	22	40	1.5				
AHFM-WN09T3-D063-A22-Z06-H	●	63	6	22	40	1.5				2508-M10x30

R: Sağ / Right / Rechts L: Sol/Left/Links

● Stokta / In Stock / Auf Lager ○ Stokta Yok / Non Stock Item / Kein Lagerartikel, Lieferzeit auf Anfrage
KRLY Ucuna Uygundur. / Compatible with KRLY Insert. Kompatibel mit KRLY Wendeplatten.

Sipariş Örneği/Ordering Example/Bestellbeispiel

1 ad./pcs./stück AHFM-WN0907-D050-A22-Z04-H

Kesme Hesabı : S 331 / Cutting Calculation : P 331 / Schnittberechnung : 331

Montaj Ölçüleri : S 328 / Mounting Reference : P 328 / Montagehinweis : 328

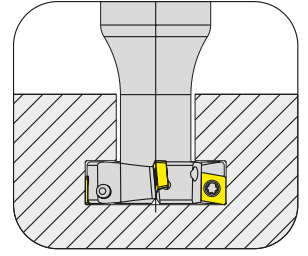
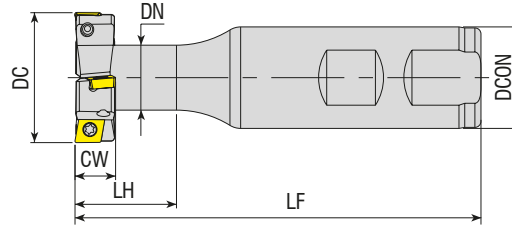

Takım Kodu
Ordering Code
Bestell-Bezeichnung

Stok
Stock
Lager

Takım Ölçüleri (mm)
Dimension (mm)
Abmessung (mm)

Kesici Uç
Insert
Wendeschneidplatte

Yedek Parçaları / Spare Parts / Ersatzteile

Tork Anahtar
Torx Key
Torx-Schlüssel

Montaj Vidası
Mounting Screw
Befestigungsschraube

	Stok	ZEFP		DC	CW	DCON	LF	DN	LH	Kesici Uç	Tork Anahtar	Montaj Vidası
		Toplam	Etkili									
	Stock	Total	Effective									
	Lager	Gesamt	Effektiv							Wendeschneidplatte	Torx-Schlüssel	Befestigungsschraube
ATSM90-CC06-D17X8-W16-L85-Z02	●	2	1	17	8	16	85	10	16	CC.. 0602..	3008-M2.5x6	80-T08
ATSM90-CC06-D32X8-W25-L100-Z04	●	4	2	32	8	25	100	16	23			
ATSM90-CC06-D28X8-W20-L66-Z04	●	4	2	28	8	20	66	14	15.5			
ATSM90-CC06-D45.5X8-W25-L100-Z06	●	6	3	45.5	8	25	100	12	30			
ATSM90-CC06-D63X8-W32-L125-Z08	●	8	4	63	8	32	125	31.5	30			
ATSM90-CC06-D18X9-W16-L90-Z02	●	2	1	18	9	16	90	10	16			
ATSM90-CC06-D20X9-W16-L85-Z04	●	4	2	20	9	16	85	10	16			
ATSM90-CC06-D23X10-W20-L90-Z04	●	4	2	23	10	20	90	12	25			
ATSM90-CC06-D32X10-W25-L100-Z04	●	4	2	32	10	25	100	16	25			
ATSM90-CC06-D45X10-W32-L120-Z06	●	6	3	45	10	32	120	20	25			
ATSM90-CC06-D25X11-W25-L100-Z04	●	4	2	25	11	25	100	13	20	CC.. 09T3..	4015-M3.5x9	80-T15
ATSM90-CC09-D30X12-W25-L100-Z04	●	4	2	30	12	25	100	16	25			
ATSM90-CC09-D32X12-W25-L100-Z02	●	2	1	32	12	25	100	16	25			
ATSM90-CC09-D32X12-W25-L100-Z04	●	4	2	32	12	25	100	16	25			
ATSM90-CC09-D32X14-W25-L100-Z04	●	4	2	32	14	25	100	16	25			
ATSM90-CC09-D37X16-W32-L120-Z04	●	4	2	37	16	32	120	17	30			
ATSM90-CC09-D42X17-W32-L120-Z04	●	4	2	42	17	32	120	19	30			
ATSM90-CC09-D40X17-W32-L120-Z04-H	●	4	2	40	17	32	120	19	30	CC.. 1204..	1020-M5x11	80-T20
ATSM90-CC12-D47X20-W32-L120-Z04	●	4	2	47	20	32	120	25	45			
ATSM90-CC12-D52X21-W32-L120-Z04	●	4	2	52	21	32	120	25	45			
ATSM90-CC12-D50X22-W32-L120-Z04	●	4	2	50	22	32	120	25	45			
ATSM90-CC12-D55X22-W32-L120-Z04	●	4	2	55	22	32	120	25	45			

R: Sağ / Right / Rechts L: Sol/Left/Links

● Stokta / In Stock / Auf Lager ○ Stokta Yok / Non Stock Item / Kein Lagerartikel, Lieferzeit auf Anfrage

Sipariş Örneği/Ordering Example/Bestellbeispiel

1 ad./pcs./stück ATSM90-CC06-D17X8-W16-L85-Z02

Kesme Hesabı : S 331 / Cutting Calculation : P 331 / Schnittberechnung : 331



KAPR=90°

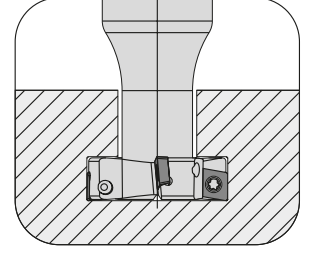
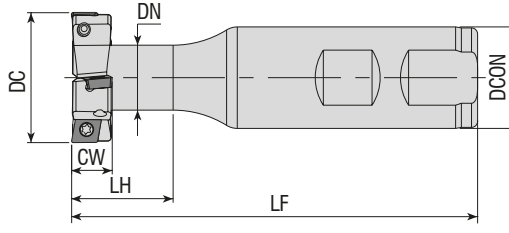

Takım Kodu
Ordering Code
Bestell-Bezeichnung

Stok
Stock
Lager

Takım Ölçüleri (mm)
Dimension (mm)
Abmessung (mm)

Kesici Uç
Insert
Wendeschneidplatte

Yedek Parçaları / Spare Parts / Ersatzteile

Tork Anahtar
Torx Key
Torx-Schlüssel

Montaj Vidası
Mounting Screw
Befestigungsschraube

ZEFP
Toplam
Total
Gesamt

Etikli
Effective
Effektiv

DC

CW

DCON

LF

DN

LH



ATSM90-SP..05-D22.5X5-W25-L100-Z04	●	4	2	22.5	5	25	100	12	25	SPMG 050204 TGTC UCUNA UYGUNDUR. FOR TGTC INSERT. Kompatibel mit TGTC-Wendeplatten	3006-M2x4	80-T06
ATSM90-SP..05-D30X5-W25-L100-Z04	●	4	2	30	5	25	100	10	25			
ATSM90-SPGT0502-D63X6-W32-L125-Z10	●	10	5	63	6	32	125	31	30	SPGT 050204		
ATSM90-SPGT0904-D32X14-W32-L120-Z04-H	●	4	2	32	14	32	120	17.5	30	SPGT 090408 ZCC UCUNA UYGUNDUR. FOR ZCC INSERT. Kompatibel mit ZCC-Wendeplatten	4015-M3.5x9	80-T15
ATSM90-SPGT0904-D37X16-W32-L120-Z04-H	●	4	2	37	16	32	120	21	40			
ATSM90-SPGT0904-D42X17-W32-L120-Z04-H	●	4	2	42	17	32	120	21	40			
ATSM90-SPGT1104-D47X20-W32-L120-Z04-H	●	4	2	47	20	32	120	24	45	SPGT 110408	4015-M4x11	
ATSM90-SP..06-D80X7-W32-L120-Z10	●	10	5	80	7	32	120	32	30	SPMG 060204 TGTC UCUNA UYGUNDUR. FOR TGTC INSERT. Kompatibel mit TGTC-Wendeplatten	3007-M2.2x5	80-T07

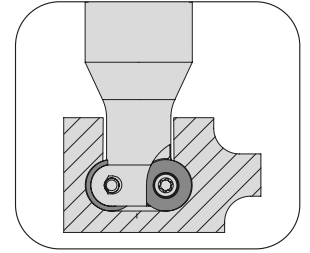
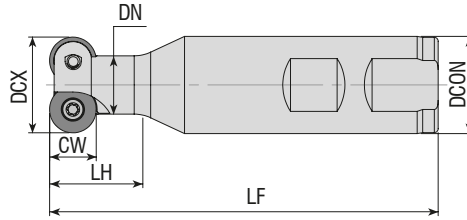

Takım Kodu
Ordering Code
Bestell-Bezeichnung

Stok
Stock
Lager

Takım Ölçüleri (mm)
Dimension (mm)
Abmessung (mm)

Kesici Uç
Insert
Wendeschneidplatte

Yedek Parçaları / Spare Parts / Ersatzteile

Tork Anahtar
Torx Key
Torx-Schlüssel

Montaj Vidası
Mounting Screw
Befestigungsschraube

ZEFP

DCX

CW

DCON

LF

DN

LH



ATSMR-RD0702-D17-W16-L90-Z02	●	2	17	7	16	90	10	12	RD.. 0702	3008-M2.5x6	80-T08
ATSMR-RD0702-D25-W16-L90-Z03	●	3	25	7	16	90	15	12			
ATSMR-RD0702-D35-W25-L100-Z05	●	5	35	7	25	100	20	20	RD.. 1003	4015-M3.5x9	80-T15
ATSMR-RD1003-D21-W25-L100-Z02	●	2	21	10	25	100	12	20			
ATSMR-RD1003-D80-W32-L165-Z06-H	●	6	80	10	32	165	30	31.5	RD.. 12T3	4015-M4.5x11	
ATSMR-RD12T3-D25-W25-L100-Z02	●	2	25	12	25	100	15	24			
ATSMR-RD12T3-D80-W32-L165-Z06-H	●	6	80	12	32	165	30	31.5			
ATSMR-RD1604-D34-W32-L110-Z02	●	2	34	16	32	110	20	30	RD.. 1604		

R: Sağ / Right / Rechts L: Sol/Left/Links

● Stokta / In Stock / Auf Lager ○ Stokta Yok / Non Stock Item / Kein Lagerartikel, Lieferzeit auf Anfrage
ISO Ucuna Uygundur. / Compatiple with ISO Insert. Kompatibel mit ISO Wendeplatten.

Sipariş Örneği/Ordering Example/Bestellbeispiel

1 ad./pcs./stück ATSM90-SP..05-D22.5X5-W25-L100-Z04

Kesme Hesabı : S 331 / Cutting Calculation : P 331 / Schnittberechnung : 331

KAPR=90°

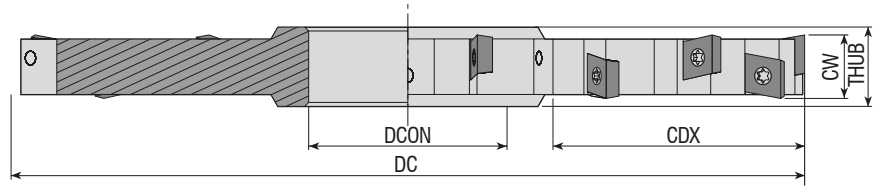

Takım Kodu
Ordering Code
Bestell-Bezeichnung

Stok
Stock
Lager

ZEFP

Toplam
Total
Gesamt

Etkili
Effective
Effektiv

DC

CW

CDX

DCON

THUB

Takım Ölçüleri (mm)
Dimension (mm)
Abmessung (mm)

Kesici Uç
Insert
Wendeschneidplatte

Yedek Parçaları / Spare Parts / Ersatzteile

Tork Anahtar
Torx Key
Torx-Schlüssel

Montaj Vidası
Mounting Screw
Befestigungsschraube

Takım Kodu Ordering Code Bestell-Bezeichnung	Stok Stock Lager	ZEFP		DC	CW	CDX	DCON	THUB	Kesici Uç Insert Wendeschneidplatte	Tork Anahtar Torx Key Torx-Schlüssel	Montaj Vidası Mounting Screw Befestigungsschraube
		Toplam Total Gesamt	Etkili Effective Effektiv								
ASDM-SPGT05-D80x6-d27-Z10	●	10	5	80	6	17	27	10	SPGT 050204 ZCC UCUNA UYGUNDUR. FOR ZCC INSERT. Kompatibel mit ZCC Wendepfatten	3006-M2x4	80-T06
ASDM-SPGT05-D100x6-d32-Z12	●	12	6	100	6	25	32	10			
ASDM-SPGT05-D125x6-d40-Z14	●	14	7	125	6	35	40	10			
ASDM-SPGT05-D160x6-d40-Z18	●	18	9	160	6	52	40	10			
ASDM-SPGT06-D80x7-d27-Z10	●	10	5	80	7	17	27	11	SPGT 060204 ZCC UCUNA UYGUNDUR. FOR ZCC INSERT. Kompatibel mit ZCC Wendepfatten	3007-M2.2x5	80-T07
ASDM-SPGT06-D100x7-d32-Z12	●	12	6	100	7	25	32	11			
ASDM-SPGT06-D125x7-d40-Z14	●	14	7	125	7	35	40	11			
ASDM-SPGT06-D160x7-d40-Z16	●	16	8	160	7	52	40	11			
ASDM-SPGT06-D200x7-d40-Z18	●	18	9	200	7	70	40	11	SPGT 07T308	3008-M2.5x6	80-T08
ASDM-SPGT07-D100x10-d32-Z12	●	12	6	100	10	25	32	11			

R: Sağ / Right / Rechts L: Sol/Left/Links

● Stokta / In Stock / Auf Lager ○ Stokta Yok / Non Stock Item / Kein Lagerartikel, Lieferzeit auf Anfrage

Sipariş Örneği/Ordering Example/ Bestellbeispiel

1 ad./pcs./stück ASDM-SPGT05-D80x6-d27-Z10

Kesme Hesabı : S 331 / Cutting Calculation : P 331 / Schnittberechnung : 331



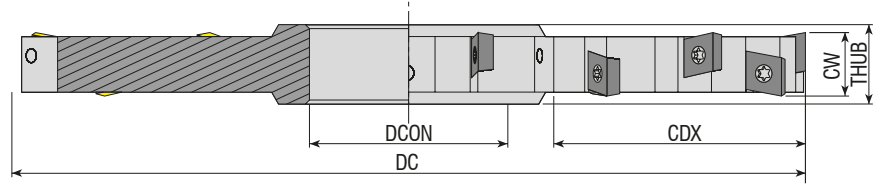

Takım Kodu
Ordering Code
Bestell-Bezeichnung

Stok
Stock
Lager

Takım Ölçüleri (mm)
Dimension (mm)
Abmessung (mm)

Kesici Uç
Insert
Wendeschneidplatte

Yedek Parçaları / Spare Parts / Ersatzteile

Tork Anahtar
Torx Key
Torx-Schlüssel

Montaj Vidası
Mounting Screw
Befestigungsschraube

ZEFP	Toplam Total Gesamt	Etkili Effektiv Effektiv	DC	CW	CDX	DCON	THUB	Kesici Uç Insert Wendeschneidplatte	Tork Anahtar Torx Key Torx-Schlüssel	Montaj Vidası Mounting Screw Befestigungsschraube
ASDM-CC06-D80x8-d27-Z10	● 10	5	80	8	17	27	12	CC.. 0602.. ISO UCUNA UYGUNDUR. <i>FOR ISO INSERT.</i> <i>Kompatibel mit ISO Wendeschneidplatten</i>	3008-M2.5x6	80-T08
ASDM-CC06-D100x8-d32-Z12	● 12	6	100	8	25	32	12			
ASDM-CC06-D125x8-d40-Z14	● 14	7	125	8	35	40	12			
ASDM-CC06-D160x8-d40-Z16	● 16	8	160	8	52	40	12			
ASDM-CC06-D200x8-d40-Z18	● 18	9	200	8	70	40	12			
ASDM-CC06-D80x10-d27-Z10	● 10	5	80	10	17	27	14			
ASDM-CC06-D100x10-d32-Z12	● 12	6	100	10	25	32	14			
ASDM-CC06-D125x10-d40-Z14	● 14	7	125	10	35	40	14			
ASDM-CC06-D160x10-d40-Z16	● 16	8	160	10	52	40	14			
ASDM-CC06-D200x10-d40-Z18	● 18	9	200	10	70	40	14			
ASDM-CC09-D80x12-d27-Z08	● 8	4	80	12	17	27	16	CC.. 09T3.. ISO UCUNA UYGUNDUR. <i>FOR ISO INSERT.</i> <i>Kompatibel mit ISO Wendeschneidplatten</i>	4015-M3.5x11	80-T15
ASDM-CC09-D100x12-d32-Z10	● 10	5	100	12	25	32	16			
ASDM-CC09-D125x12-d40-Z12	● 12	6	125	12	35	40	16			
ASDM-CC09-D160x12-d40-Z14	● 14	7	160	12	52	40	16			
ASDM-CC09-D200x12-d40-Z16	● 16	8	200	12	70	40	16			
ASDM-CC09-D80x14-d27-Z08	● 8	4	80	14	17	27	18			
ASDM-CC09-D100x14-d32-Z10	● 10	5	100	14	25	32	18			
ASDM-CC09-D125x14-d40-Z12	● 12	6	125	14	35	40	18			
ASDM-CC09-D160x14-d40-Z14	● 14	7	160	14	52	40	18			
ASDM-CC09-D200x14-d40-Z16	● 16	8	200	14	70	40	18			
ASDM-CC12-D80x16-d27-Z06	● 6	3	80	16	17	27	20	CC.. 1204.. ISO UCUNA UYGUNDUR. <i>FOR ISO INSERT.</i> <i>Kompatibel mit ISO Wendeschneidplatten</i>	1020-M5x11	80-T20
ASDM-CC12-D100x16-d32-Z08	● 8	4	100	16	25	32	20			
ASDM-CC12-D125x16-d40-Z10	● 10	5	125	16	35	40	20			
ASDM-CC12-D160x16-d40-Z12	● 12	6	160	16	52	40	20			
ASDM-CC12-D200x16-d40-Z14	● 14	7	200	16	70	40	20			
ASDM-CC12-D80x18-d27-Z06	● 6	3	80	18	17	27	22			
ASDM-CC12-D100x18-d32-Z08	● 8	4	100	18	25	32	22			
ASDM-CC12-D125x18-d40-Z10	● 10	5	125	18	35	40	22			
ASDM-CC12-D160x18-d40-Z12	● 12	6	160	18	52	40	22			
ASDM-CC12-D200x18-d40-Z14	● 14	7	200	18	70	40	22			
ASDM-CC12-D250x18-d40-Z16	● 16	8	250	18	90	40	22			
ASDM-CC12-D80x20-d27-Z06	● 6	3	80	20	17	27	24			
ASDM-CC12-D100x20-d32-Z08	● 8	4	100	20	25	32	24			
ASDM-CC12-D125x20-d40-Z10	● 10	5	125	20	35	40	24			
ASDM-CC12-D160x20-d40-Z12	● 12	6	160	20	52	40	24			
ASDM-CC12-D200x20-d40-Z14	● 14	7	200	20	70	40	24			
ASDM-CC12-D250x20-d40-Z16	● 16	8	250	20	90	40	24			

R: Sağ / Right / Rechts L: Sol/Left/Links

● Stokta / In Stock / Auf Lager ○ Stokta Yok / Non Stock Item / Kein Lagerartikel, Lieferzeit auf Anfrage

Sipariş Örneği/Ordering Example/Bestellbeispiel

1 ad./pcs./stück ASDM-CC06-D80x8-d27-Z10

Kesme Hesabı : S 331 / Cutting Calculation : P 331 / Schnittberechnung : 331

A TIP / A TYPE / A-Typ

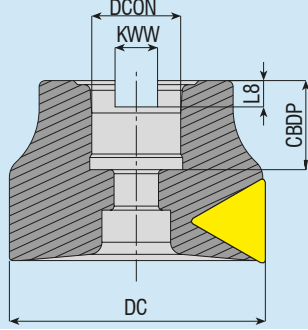

DC	DCON	DBC	KWW	L8	CBDP
40	16	-	8.4	5.6	20
50	22	-	10.4	6.3	22
63	22	-	10.4	6.3	22
80	27	-	12.4	7	25
100	32	-	14.4	8	26

B TIP / B TYPE / B-Typ

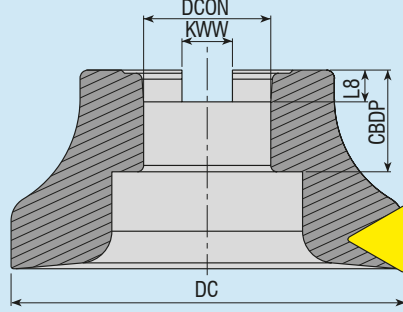

DC	DCON	DBC	KWW	L8	CBDP
125	40	-	16.4	9	32

C TIP / C TYPE / C-Typ

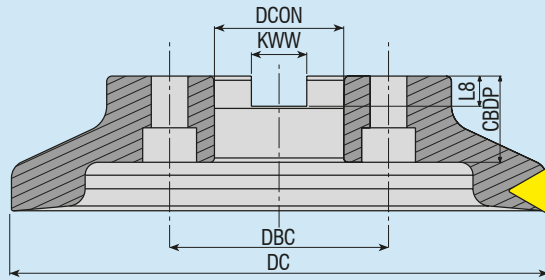

DC	DCON	DBC	KWW	L8	CBDP
160	40	66.7	16.4	9	32
200	60	101.6	25.7	14	40
250	60	101.6	25.7	14	40

D TIP / D TYPE / D-Typ

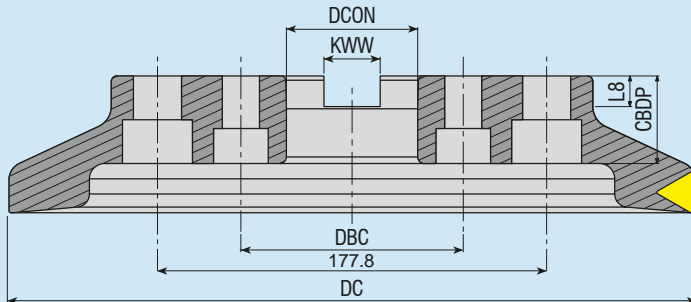

DC	DCON	DBC	KWW	L8	CBDP
315	60	101.6	25.7	14	40

TAKMA UÇLU MATKAP (U-DRILL) KULLANMA KILAVUZU

Matkabınızı CNC torna tezgahına bağlamadan önce taretin merkezden kaçık olup olmadığını kontrol etmeniz gerekir. Şayet taretinizde kaçıklık varsa, takma uçlu matkabınızı kesinlikle kullanmayınız. Taretin düzeltilmesi için yapılması gereken işlemler ;

1. Taretin tutucusuna kullanacağınız takma uçlu matkabın çapında ve boyunda üzeri hassas olan silindirik bir parça bağlanır ve tazgahın X değeri sıfıra getirilir.
2. Tezgahın aynasına mıknatıslı komprotör saati yerleştirilir. Saatin uç kısmı tarete bağlanmış olduğumuz parçanın üstüne temas ettirilir.
3. Aynanın üzerine bağlanmış olduğumuz mıknatıslı komprotör ayna ile beraber 360 derece döndürülerek saatteki değişim oranına göre taretin sıfırlanması sağlanır.

TAKMA UÇLU MATKABINIZI CNC TORNANIZDA DAHA VERİMLİ KULLANMANIZ İÇİN GEREKLİ OLAN KESME HIZLARI ve DEVİRLERİ :

Grup No.	Malzemenin Cinsi	Malzemenin Öz.	Kesme Hızı Vc (m/dk)
1	Çok Yumuşak İş Çelikleri	C1010, Otomat vb.	220
2	İmalat Çelik ve Döküm Malz.	C1030 - 106 vb.	200
3	Takım ve İmalat Çeşitleri	CK-45, 4140, 7131 vb.	170
4	Sıcak İş ve Paslanmaz Çelikler	İmpaks vb.	150

Devir hesabı yapabilmek için önce malzemeyi seçiniz. Seçtiğiniz malzemenin kesme hızını (Vc) 1000 ile çarpıp 3.14'e bölmeliyiz. Çıkan değeri matkap çapına bölmeliyiz. **ÖRNEK** : Malzememiz takım ve imalat çeliği (3. grup), matkap çapı 25 mm kesme hızı 170 ise $170 \times 1000 = 170000 / 3.14 = 54140$, $54140 / 25 = 2166$ devir çıkar (Tezgahın İş Mili Devri). Tezgahın ilerlemesi kullanacağınız uç ile de alakalı olup 0.05 ile 0.10 arasında değişim gösterir. Kullanıcı kesici ucun kesişine göre bunu ayarlar.

İŞLEME MERKEZLERİ İÇİN İLERLEME HESABI :

Yukarıdaki hesaplamalarla bulmuş olduğunuz 2166 iş mili devrini, kesici uç ilerlemesi (mm/devir) 0.05 ile 0.10 arasındaki ilerleme seçenekleri ile çarpılır. **ÖRNEK 1** : $2166 \times 0.05 = 108$ **ÖRNEK 2** : $2166 \times 0.10 = 217$ çıkan sonuçlar 108 ve 217 işleme merkezleri için ilerleme mm/dakika hesabıdır.

Not: D4 ve üzeri takma uçlu matkaplarda tezgahın içten su verme basıncının en az 6 bar olması gerekmektedir.

USER'S GUIDE FOR AKKO U-DRILLS

Before connecting your U-Drill to CNC lathe, you have to check if the turret is eccentric from the center or not. If there is any eccentricity in your turret, never use your U-Drill;

Processes that should be done to fix the turret :

1. A cylindrical part whose surface is precision and whose length and diameter is the same with the U-Drill that you will use, should be mounted to the holder of turret and X value of the lathe should be brought to zero (0).
2. Comparator should be mounted to chuck. The end of the comparator should be contacted (touched) to the surface of the part that we mounted on the turret.
3. The comparator that we mounted on the chuck should be turned 360-degree with the chuck and turret should be zeroed by that turning according to changing rate of comparator.

CUTTING SPEED AND REVOLUTION THAT ARE NEEDED FOR USING (RUNNING) YOUR U-DRILLS MORE PRODUCTIVELY

Grup No.	Material	Material Type	Cutting Speed Vc (m/m)
1	Non-alloy steel and free cutting steel	C1010. Automat etc.	220
2	Low alloy steel and cast steel	C1030 - 106 etc.	200
3	Alloy steel and tool steel	CK-45, 4140, 7131 etc.	170
4	Hot Work Steel and Stainless Steel	Impax etc.	150

P.S. : The cutting speed may be concerned with the type of the insert that you use.

Fistly, choose the material to make calculation of revolution. You should multiply the cutting speed (Vc) of the material that you chose by 1000 and divide by 3.14. You should divide the value that you found by the diameter of U-Drill. For Example : If our material is alloy steel and tool steel (3rd group), diameter of the U-Drill is 25 mm, cutting speed is 170, we should calculate as following; $170 \times 1000 = 170000 / 3.14 = 54140$, $54140 / 25 = 2166$ rpm is the result that we found (Spindle Speed) Feed rate of the lathe is concerned with the U-Drill that you will use and changes between 0.05 and 0.10. The user sets it according to cut of cutting insert.

FEED CALCULATION FOR CENTRAL MACHINE :

2166 spindle speed, that we found as a result of above mentioned calculation, should be multiplied by cutting insert feed (mm/r) between 0.05 and 0.10 feed choisses. Example 1 : $2166 \times 0.05 = 108$

Example 2 : $2166 \times 0.10 = 217$ The results 108 and 217 are the feed mm/m calculation for central machine.

Note: Cooling water pressure of lathe must be minimum 6 bar for our D4 u-drills and u-dirlls longer than D4.

GEBRAUCHSANLEITUNG FÜR AKKO-VOLLBOHRER

Bevor Sie den Vollbohrer auf die Drehmaschine montieren, prüfen Sie bitte ob der Revolverkopf zentrisch sitzt. Sollte der Revolverkopf aus der Mitte stehen, benutzen Sie den Vollbohrer bitte nicht. Auf folgende Weise können Sie den Revolverkopf zentrieren:

1. Setzen Sie ein präzises Drehteil, das die gleiche Länge und den gleichen Durchmesser hat wie der eingesetzte Vollbohrer, in den Halter vom Revolverkopf und justieren Sie den X-Wert der Drehmaschine auf null.
2. Setzen Sie bitte einen Messtaster in das Spannfutter ein. Der Fühler des Messtasters sollte mit der Oberfläche des Präzisionsteils im Revolver Kontakt haben.
3. Drehen Sie nun das Spannfutter mit dem Messtaster um 360°. Die angezeigte Abweichung zwischen Futter und Revolver sollte null betragen.

SCHNITTGESCHWINDIGKEIT UND DREHZAHL UM DIE VOLLBOHRER WIRTSCHAFTLICH EINZUSETZEN

Hauptgruppe	Hauptgruppe	Materialbezeichnung	Schnittgeschwindigkeit vc (m/min.)
1	Nicht Legierter Stahl und Automatenstahl	C1010. Automatenstahl	220
2	Niedrig Legierter Stahl und Stahlguss	C1030 - 106 vb.	200
3	Legierter Stahl und Werkzeugstahl	CK-45, 4140, 7131 vb.	170
4	Warmarbeitsstahl und Rostfreier Stahl	Impax und weitere Chrom-Nickel-Stähle	150

P.S.: Die genaue Schnittgeschwindigkeit hängt von der verwendeten Wendeschneidplatte ab. In Abhängigkeit vom Material wählen Sie die Schnittgeschwindigkeit vc. Diesen Wert multiplizieren Sie mit 1000 und teilen ihn durch 3,14 und den Durchmesser des Werkzeugs (in mm).

Beispiel: Rostfreier Stahl (Hauptgruppe 3), Werkzeugdurchmesser 25 mm, Schnittgeschwindigkeit vc=170 m/min. Die Berechnung sieht wie folgt aus: $170 \times 1000 / 3,14 = 54140 / 25 = 2166$ U/min. (Spindeldrehzahl). Der Vorschub der Maschine hängt vom Vollbohrer und der verwendeten Wendeschneidplatte ab und variiert zwischen 0,05 mm und 0,1 mm / Umdrehung.

VORSCHRUBBERECHNUNG :

Die oben berechnete Spindeldrehzahl von 2166 wird mit dem Vorschub 0,05 mm und 0,1 mm multipliziert. $2166 \text{ Umdr./min.} \times 0,05 \text{ mm/Umdr.} = 108 \text{ mm/min.}$ $2166 \text{ Umdr./min.} \times 0,1 \text{ mm/Umdr.} = 216 \text{ mm/min.}$ D.h. der Vorschub liegt zwischen 108 mm/min. und 216 mm/min. Hinweis: Der Kühlmitteldruck muss mindestens 6 bar betragen für die Vollbohrer mit $\geq 4 \times D$

SIKMA TORKU TAVSİYELERİ - RECOMMENDED TIGHTENING TORQUE EMPFOLHENES ANZUGSMOMENT

- Takımı Sıkmadan Önce Aşağıdaki Bilgileri Okuyunuz.
Read below information before tightening the tool.
Bitte lesen Sie die nachfolgenden Informationen bevor Sie das Werkzeug spannen.
- Vidalı Takımın Vida Ölçüsü ile Tutucunun İç Vida Ölçüsünü Sıkmadan Önce Kontrol Ediniz.
Check screw set's the screw size and together with mounting arbor inner dimension of screws.
Prüfen Sie, ob das Gewinde vom Werkzeug mit dem Gewinde in der Verlängerung identisch ist.
- Takımı Tutucuya Sıkarken Tablodaki İlgili Değerlere Göre İşlem Yapınız.
When tightening head to an arbor, follow the related tightening torque in the table.
Wenn Sie den Einschraubfräser festziehen, beachten Sie bitte die angegebenen Anzugsmomente.

Vida Screw Schraube	Tork Torque (N.m) Anzugsmoment (N.m)
M6	8
M8	23
M10	46
M12	80
M16	90

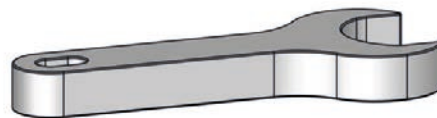

FREZELEME İŞLEMİNDE DEVİR ve İLERLEME HESABI

Vc.	S	D	F	Z	fz	FORMÜLLER
Kesme Hızı (Uç Kutusunun Arkasından Okuyunuz)	İş Mili Devir Sayısı	Tarama Kafası Çapı	İlerleme	Tarama Kafası Ağız Sayısı	Diş Başına Düşen İlerleme Miktarı (Uç Kutusunun Arkasından Okuyunuz)	Devir Hesabı : $S=(Vc \times 1000) / (3,14 \times D)$ İlerleme Hesabı : $F=S \times Z \times fz$

Örnek : D=50 mm çapında, Z=5 ağızlı tarama kafası ile frezeleme yapacağız. Kesici uç kutusunun arkasında kesme hızı Vc=200m/dk. olarak verilmiş olsun. Tezgaha girilecek devri hesaplayalım: **Vc=200 m/dk. D=50 mm S =** Öncelikle Kesme Hızı 1000 ile çarpılır, çıkan sonuç 3,14 sayısına bölünür, buradan çıkan sonuç da tarama kafası çapına bölünür.

$S=200 \times 1000 = 200000 \rightarrow 200000/3,14=63663 \rightarrow 63663/50=1273$ devir **S=1273 dev/dakika** devri bulduktan sonra ilerlemeyi bulalım: **Z=5** ağızlı tarama kafası olsun **fz=0,12** olarak uç kutusunun arkasından okunmuş olsun F= yukarıda bulmuş olduğumuz devir sayısı ile ağız sayısı çarpılır, çıkan sonuç diş başına düşen ilerleme miktarı ile çarpılır.

$F=1273 \times 5 = 6365 \rightarrow 6365 \times 0,12 = 763$ $F=763$ mm/dakika

Tezgaha girilecek olan devir = S 1273 Tezgaha girilecek olan ilerleme : **F 763 ortalama değerdir.**

Not: Vc ve fz değerlerinin uç kutusunun arkasında verilmiş olması gerekir. Eğer bu değerler uç kutusunun üzerinde yoksa, kesici ucun katalogundan bulunuz. İşleyeceğiniz malzeme çelik ise P, paslanmaz çelik ise M, dökme demir ise K bölümünde yazılı olan Vc ve fz değerlerini okuyun.

CALCULATING SPINDLE SPEED and FEED RATE FOR MILLING PROCESS

Vc.	S	D	F	Z	fz	FORMULAS
Cutting Speed (Please read from the back- side of cutting insert box)	Spindle Revolution rpm	Milling Tool Diameter	Feed Rate	Number of Effective Tooth	Feed Per Tooth (Please Read From The Back Side of Cutting Insert Box)	Calculation of Revolution : $S=(Vc \times 1000) / (3,14 \times D)$ Feed Rate Calculation : $F=S \times Z \times fz$

For Example : We will make milling with milling tool whose diameter is D 50 mm, whose teeth number is Z=5. The spindle revolution was written as Vc=200m/mn at the back side of cutting insert box. Let's calculate the revolution that should be entered to the milling machine : Vc=200 m/mn D=50 mm
S = Firstly Cutting Speed is multiplied with 1000, the result should be divided by 3.14 , the last result should be divided by diameter of milling tool.

$S = 200 \times 1000 = 200000 \rightarrow 200000/3,14 = 63663 \rightarrow 63663/50 = 1273$ rev $S=1273$ rev / mn

After finding spindle revolution, let's find feed rate : milling tool with Z=5 teeth and we read fz=0,12 from the back side of cutting insert box.

F = Tooth number should be multiplied with revolution, the result should be multiplied with feed per tooth.

$F = 1273 \times 5 = 6365 \rightarrow 6365 \times 0,12 = 763$ $F = 763$ mm / mn

Revolution that should be entered to the milling machine = S 1273 Feed Rate that should be entered to the milling machine = F 763 average value.

P.S : The values Vc and fz has to be written at the back side of the cutting insert. If these values were not written on the cutting insert box, please find them from cutting insert catalogue. If the material that you will work is steel, please read Vc and fz values that were written on the part P, if it is stainless steel please read from the part M, if it is cast iron please read from the part K.

BERECHNUNG VON DREHZAHL UND VORSCHUB FÜR FRÄSWERKZEUGE

Vc.	S	D	F	Z	fz	Formeln
Schnittgeschwindigkeit (finden Sie z.B. auf der Verpackung der Wendeschneidplatte)	Spindel Drehzahl	Fräswerkzeug Durchmesser	Vorschubgeschwindigkeit	Anzahl der effektiven Zähne	Vorschub pro Zahn (finden Sie z.B. auf der Verpackung der Wendeschneidplatte)	Berechnung der Drehzahl: $n=(vc \times 1000) / (3,14 \times D)$ Vorschubberechnung: $F=n \times Z \times fz$

Beispiel: Fräswerkzeug mit D=50 mm und Z=5. Schnittgeschwindigkeit vc=200 m/min. (laut Wendeschneidplattenverpackung).

Berechnung der Drehzahl: $n=200 \text{ m/min.} \times 1000 = 200000 / 3,14=63694 / 50 \text{ mm} = 1273$ Umdr./min.

Berechnung des Vorschubs: Ermittlung von fz (finden Sie z.B. auf der Verpackung der Wendeschneidplatte), für das Berechnungsbeispiel fz=0,12 mm $F = n \times Z \times fz = 1273 \times 5 \times 0,12 = 763$ mm/min. D.h., Sie stellen an der Maschine folgende Werte ein: Drehzahl n = 1273 Umdr./min., Vorschub F = 763 mm/min.

P.S.: Die Werte für vc und fz finden Sie auf der Rückseite der Wendeschneidplattenverpackung. Sollten diese Werte dort nicht stehen, können Sie diese auch im Wendeschneidplattenkatalog finden. Für Stahl wählen Sie für vc und fz bitte die Werte aus dem Bereich P, für rostfreien Stahl aus dem Bereich M und für Guss aus dem Bereich K.

Gövde Malzemesine Göre Delik İçi Kater Uygulama Kılavuzu

Internal Boring Bars Application Guide, Related to Body Material

Anwendungshinweise für Bohrstangen, abhängig vom Bohrstangen-Material

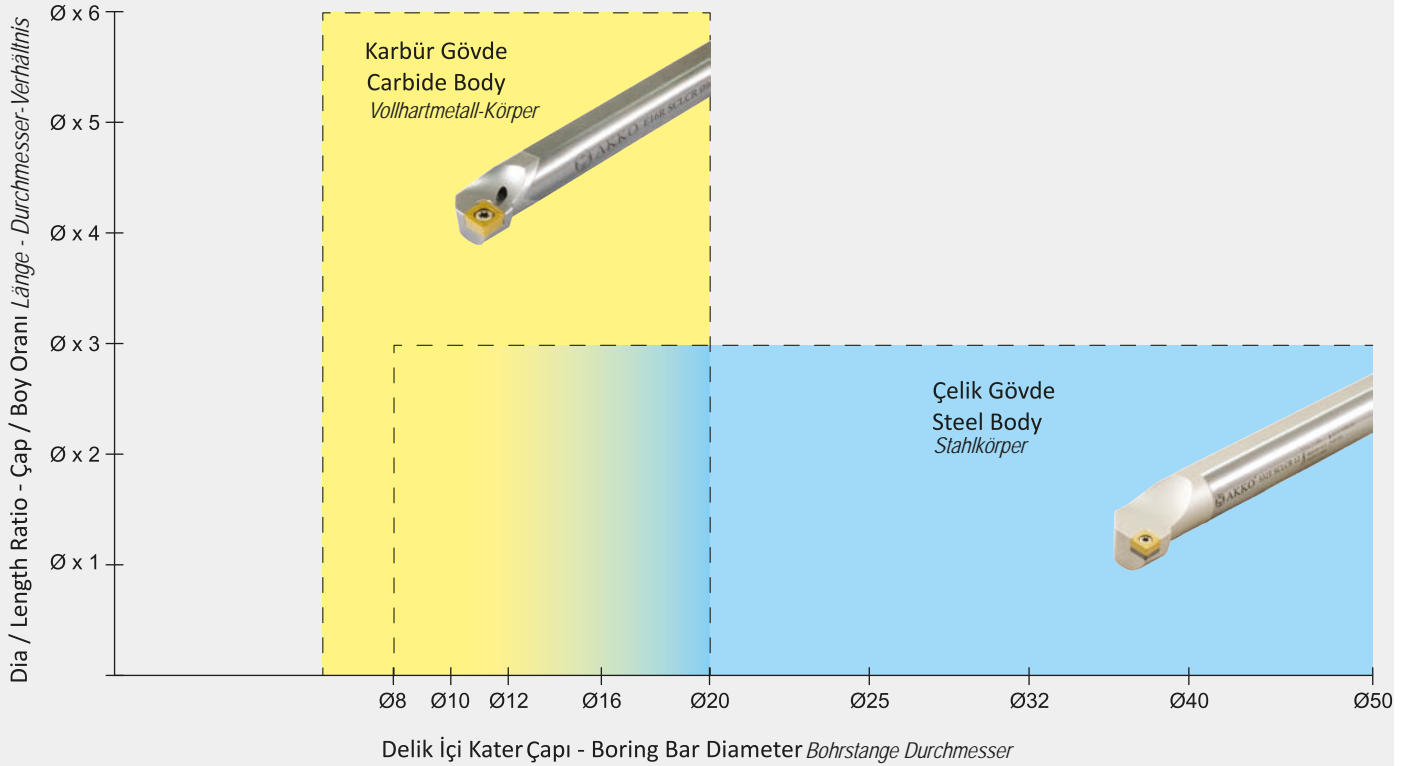

T Kanal Freze Kullanım ve Ön Hazırlama Kılavuzu

Application Guide For T-Slot Milling

Anwendungshinweise für T-Nutenfräser

T kanal frezelemede talaşın rahat boşaltılması için iş parçası resimde gösterildiği şekilde işlenmelidir.

Örnek: ATSM90-CC06- D32X10-W25- L100-Z04 kodlu T freze ile kanal açmadan önce, takımın boğazının çalışacağı kısmın parmak freze ile işlenmesi gerekir. Bu durumda kanalın tamamen işlenmesi çok yanlıştır. Tabanda ($0.8 \times b = 0.8 \times 10$) 8mm işlenmeden bırakılmalıdır. Bu bölgeyi T frezenin işlemesi, takımın daha sağlıklı çalışması açısından gereklidir.

İşlenen kanallarda yumuşak kesim için talaşlar uzaklaştırılmış olmalıdır.

When T slot machining steel, the workpiece must be machined as shown in the drawing to ensure smooth chip evacuation.

Example: Before slotting with the T - slot milling cutter - code ATSM90-CC06-D32X10-W25-L100-Z04,

The area of the neck of the tools to be worked and must be machined by End-Mill.

In this case, it is very wrong to machining the slot completely.

Bottom area ($0.8 \times b = 0.8 \times 10$) should be left 8 mm without machining.

This area's operation must be machined by the T- slot milling cutter which is also necessary for the healthier work of the tool holder.

Slots to be machined must be free from chips for smooth machining.

Beim Einsatz von T-Nutenfräsern muss das Werkstück so bearbeitet werden wie es in der Zeichnung dargestellt ist, um einen problemlosen Späne transport zu gewährleisten.

Beispiel: Einsatz des T-Nutenfräasers ATSM90-CC06-D32X10-W25-L100-Z04

Die Aussparung für den Halsbereich des T-Nutenfräasers muss mit einem Schafffräser vorgearbeitet werden. Bitte beachten Sie dabei, dass die Aussparung nicht komplett bis auf den Grund gefräst wird, sondern eine Bodenstärke von $0,8 \times b$ (im Beispiel $0,8 \times 10 \text{ mm} = 8 \text{ mm}$) im Werkstück verbleibt.

Dieser Bereich soll mit dem T-Nutenfräser bearbeitet werden, da dies für die Stabilität und Standzeit des Werkzeugs besser ist.

In der zu bearbeitenden Nut sollten keine Späne mehr vorhanden sei.

KULLANIM İÇİN UYARI

CAUTION FOR USE

Bitte beachten Sie!

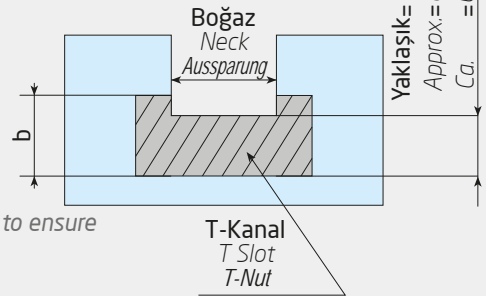

α = 5 Kat Dayanıklılık**α = 5 Times Long Life****α = 5-Fache Standzeit**

Alfa Kaplamanın Avantajları

Alpha Coating
Advantages

Vorteile der
Alpha-Beschichtung

- **Yüksek aşınma direnci**
High resistance to abrasion
Hoher Verschleißschutz
- **Yüksek yüzey sertliği**
750-800 Vickers
High surface hardness
750-800 Vickers
Hohe Oberflächenhärte von
750-800 HV
- **Temperlemeye karşı yüksek direnç**
High resistance to tempering
Hoher Temperaturwiderstand
- **Yüksek yorulma mukavemeti**
High fatigue strength
Hohe Dauerfestigkeit
- **Yüksek çizik ve çentik direnci**
High scratch and impact resistance
Hoher Kratz-und Stoß-Widerstand
- **Paslanmaz olmayan çelikler için daha yüksek korozyon direnci**
Resistant to corrosion of
non-stainless steel
Korrosionsschutz



takımınız neden
daha uzun ömürlü
olmasın?...

longer tool life...

längere Werkzeug-Standzeit

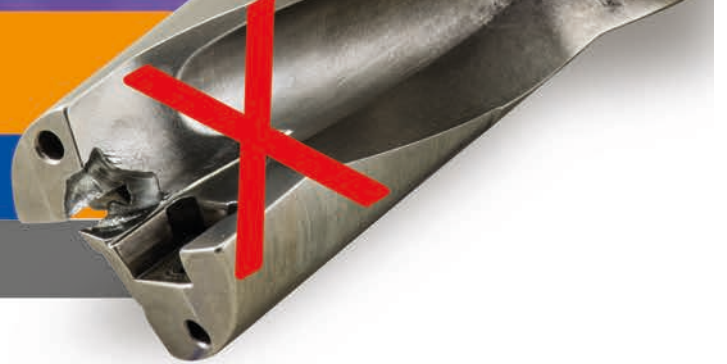

α Çevre Dostudur. α is friend of environment.
α ist umweltfreundlich.

İnsan sağlığı açısından zararlı değildir. Is not harmful to human health.
Nicht gesundheitsschädlich.

Gaz ve diğer atıkları çevreyi kirletmez. Gas and other wastes will not pollute the environment.
Umweltverträgliches Beschichtungsverfahren.

ALTLIKLAR / SHIMS / UNTERLAGE

ÜRÜN RESMİ/PICTURE BILD	ÜRÜN KODU/CODE BEZEICHNUNG	ÜRÜN DETAYI / PRODUCT DETAIL PRODUKTBESCHREIBUNG
	AATN-2-0001	S-SİSTEM için / For S-SYSTEM / FÜR S-SYSTEM
	AATN-2-0002	T-M SİSTEM için / For T-M SYSTEM / FÜR T-M-SYSTEM
	AATN-3-0025	P-SİSTEM için / For P-SYSTEM / FÜR P-SYSTEM
	AATN-3-0015	T-M-P SİSTEM için / For T-M SYSTEM / FÜR T-M-P-SYSTEM
	AATN-2-0020	DİŞ VİDA 16 ALTLIK / For THREADING 16 SHIM / GEWINDE 16 UNTERLAGE
	AATN-2-0004	DİŞ VİDA 22 ALTLIK / For THREADING 22 SHIM / GEWINDE 22 UNTERLAGE
	ATS-16E	DİŞ VİDA 16, DİŞ ÇAP SAĞ - DELİK İÇİ SOL ALTLIK / For THREADING SYSTEM 16 SHIM, EXTERNAL RIGHT-INTERNAL LEFT / FÜR 16 ER-GEWINDEPLATTE, EXTERN RECHTS - INTERN LINKS
	ATS-16I	DİŞ VİDA 16, DİŞ ÇAP SOL - DELİK İÇİ SAĞ ALTLIK / For THREADING SYSTEM 16 SHIM, EXTERNAL LEFT-INTERNAL RIGHT / FÜR 16 ER-GEWINDEPLATTE, EXTERN LINKS - INTERN RECHTS
	ATS-22E	DİŞ VİDA 22, DİŞ ÇAP SAĞ - DELİK İÇİ SOL ALTLIK / For THREADING SYSTEM 22 SHIM, EXTERNAL RIGHT-INTERNAL LEFT / FÜR 22 ER-GEWINDEPLATTE, EXTERN RECHTS - INTERN LINKS
	ATS-22I	DİŞ VİDA 22, DİŞ ÇAP SOL - DELİK İÇİ SAĞ ALTLIK / For THREADING SYSTEM 22 SHIM, EXTERNAL LEFT-INTERNAL RIGHT / FÜR 22 ER-GEWINDEPLATTE, EXTERN LINKS - INTERN RECHTS
	ATS-27E	DİŞ VİDA 27, DİŞ ÇAP SAĞ - DELİK İÇİ SOL ALTLIK / For THREADING SYSTEM 27 SHIM, EXTERNAL RIGHT-INTERNAL LEFT / FÜR 27 ER-GEWINDEPLATTE, EXTERN RECHTS - INTERN LINKS
	ATS-27I	DİŞ VİDA 27, DİŞ ÇAP SOL - DELİK İÇİ SAĞ ALTLIK / For THREADING SYSTEM 27 SHIM, EXTERNAL LEFT-INTERNAL RIGHT / FÜR 27 ER-GEWINDEPLATTE, EXTERN LINKS - INTERN RECHTS
	AACN-2-0001	S-SİSTEM için / For S-SYSTEM / FÜR S-SYSTEM
	AACN-2-0002	T-SİSTEM için / For T-SYSTEM / FÜR T-T-SYSTEM
	AACN-2-0003	P-SİSTEM için / For P-SYSTEM / FÜR P-SYSTEM
	AACN-3-0001	S-SİSTEM için / For S-SYSTEM / FÜR S-SYSTEM
	AACN-3-0002	T-M-P SİSTEM için / For T-M-P SYSTEM / FÜR T-M-P-SYSTEM
	AACN-3-0003	C-SİSTEM için / For C-SYSTEM / FÜR C-SYSTEM
	AACN-3-0002	T-P SİSTEM için / For T-P SYSTEM / FÜR T-P-SYSTEM
	AACN-3-0003	T-P SİSTEM için / For T-P SYSTEM / FÜR T-P-SYSTEM
	AAWN-2-0003	T-M-P SİSTEM için / For T-M-P SYSTEM / FÜR T-M-P-SYSTEM
	AAWN-3-0001	T-M-P SİSTEM için / For T-M-P SYSTEM / FÜR T-M-P-SYSTEM
	AAWN-SW317	T-M-P SİSTEM için / For T-M-P SYSTEM / FÜR T-M-P-SYSTEM
	AKS-16L	C-SİSTEM için / For C-SYSTEM / FÜR C-SYSTEM
	AKS-16R	C-SİSTEM için / For C-SYSTEM / FÜR C-SYSTEM
	AASD-3-0001	S-SİSTEM FREZELEME için / For S-SYSTEM MILLING / S-SYSTEM FÜR FRÄSER
	AASE-3-0001	S-SİSTEM FREZELEME için / For S-SYSTEM MILLING / S-SYSTEM FÜR FRÄSER
	AASN-2-0001	S-SİSTEM için / For S-SYSTEM / FÜR S-SYSTEM
	AASN-2-0002	P-SİSTEM için / For P-SYSTEM / FÜR P-SYSTEM
	AASN-2-0004	S-SİSTEM için / For S-SYSTEM / FÜR S-SYSTEM
	AASN-3-0004	T-P SİSTEM için / For T-P SYSTEM / FÜR T-P-SYSTEM
	AASN-3-0004	C-SİSTEM için / For C-SYSTEM / FÜR C-SYSTEM
	AASN-3-0023	T-P SİSTEM için / For T-P SYSTEM / FÜR T-P-SYSTEM
	AASN-3-0005	T-P SİSTEM için / For T-P SYSTEM / FÜR T-P-SYSTEM
	AASN-3-0020	T-P SİSTEM için / For T-P SYSTEM / FÜR T-P-SYSTEM
	AASN-20020	PSDNN KARTUŞ için / For PSDNN CARTRIDGE / FÜR PSDNN-KURZDREHHALTER
	AADN-2-0001	S-SİSTEM için / For S-SYSTEM / FÜR S-SYSTEM
	AADN-SD317	P-SİSTEM için / For P-SYSTEM / FÜR P-SYSTEM
	AADN-3-0001	T-M-P SİSTEM için / For T-M-P SYSTEM / FÜR T-M-P-SYSTEM
AADN-2-0003	C-SİSTEM için / For C-SYSTEM / FÜR C-SYSTEM	
	AAVN-2-0002	S-SİSTEM için / For S-SYSTEM / FÜR S-SYSTEM
	AAVN-2-0002	T-SİSTEM için / For T-SYSTEM / FÜR T-SYSTEM
	AARC-3-0001	C-SİSTEM için / For C-SYSTEM / FÜR C-SYSTEM
	AARC-3-0002	C-SİSTEM için / For C-SYSTEM / FÜR C-SYSTEM
	AARC-3-0003	C-SİSTEM için / For C-SYSTEM / FÜR C-SYSTEM



BASKI PABUÇLARI / CLAMPS / SPANNSPRATZE

ÜRÜN RESMİ/PICTURE BILD	ÜRÜN KODU/CODE BEZEICHNUNG	ÜRÜN DETAYI / PRODUCT DETAIL PRODUKTBESCHREIBUNG
	ATK-01	T-SİSTEM için / For T-SYSTEM / FÜR T-SYSTEM DNMG 11, WNMG 06, TNMG 16, CNMG 09 BASKI PABUCU / CLAMP / PRATZE
	ATK-02	T-SİSTEM için / For T-SYSTEM / FÜR T-SYSTEM CNMG 12, WNMG 08, TNMG 22, DNMG 15, SNMG 12 BASKI PABUCU / CLAMP / PRATZE
	ATK-03	T-SİSTEM için / For T-SYSTEM / FÜR T-SYSTEM VNMG 16 BASKI PABUCU / CLAMP / PRATZE
	ATK-04	T-SİSTEM için / For T-SYSTEM / FÜR T-SYSTEM CNMG 16, SNMG 15 BASKI PABUCU / CLAMP / PRATZE
	AMK-01	M-SİSTEM için / For M-SYSTEM / FÜR M-SYSTEM WNMG 06 BASKI PABUCU / CLAMP / PRATZE
	AMK-02	M-SİSTEM için / For M-SYSTEM / FÜR M-SYSTEM DELİK İÇİ / INTERN / INNEN Ø20 TNMG 16, Ø25 MT-NR/L 16 BASKI PABUCU / CLAMP / PRATZE
	AMK-03	M-SİSTEM için / For M-SYSTEM / FÜR M-SYSTEM DNMG 11, CNMG 12 BASKI PABUCU / CLAMP / PRATZE
	AMK-04	M-SİSTEM için / For M-SYSTEM / FÜR M-SYSTEM DNMG 15, TNMG 16-22 BASKI PABUCU / CLAMP / PRATZE
	AMK-05	M-SİSTEM için / For M-SYSTEM / FÜR M-SYSTEM WNMG 08 BASKI PABUCU / CLAMP / PRATZE
	AMK-07	M-SİSTEM için / For M-SYSTEM / FÜR M-SYSTEM S20R MCLNR/L BASKI PABUCU / CLAMP / PRATZE
	ACK-01-R	C-SİSTEM için / For C-SYSTEM / FÜR C-SYSTEM KNUX-R BASKI PABUCU / CLAMP / PRATZE
	ACK-02-L	C-SİSTEM için / For C-SYSTEM / FÜR C-SYSTEM KNUX-L BASKI PABUCU / CLAMP / PRATZE
	ACK-03	C-SİSTEM için / For C-SYSTEM / FÜR C-SYSTEM 154.91 DIŞ ÇAP ve DELİK İÇİ/EXTERNAL and INTERNAL/ AUßEN-DREHHALTER Ø25-Ø32 / PABUCU / CLAMP / PRATZE
	ACK-04	P-C-SİSTEM için / For P-C-SYSTEM / FÜR P-C-SYSTEM CTFPR KARTUŞ BASKI PABUCU / CARTRIDGE CLAMP / PRATZE FÜR KASSETTE
	ACK-05	P-C-SİSTEM için / For P-C-SYSTEM / FÜR P-C-SYSTEM FREZELEME ve DIŞ VIDA AÇMA TAKIMLARINA GÖRE İLAVE BASKI PABUCU ADDITIONAL LITTLE CLAMP for MILLING and THREADING CLAMP KLEINE ZUSATZKLEMME FÜR FRÄSER UND GEWINDEWERKZEUGE
	ACK-06	C-SİSTEM için / For C-SYSTEM / FÜR C-SYSTEM 154.91 DELİK İÇİ / INTERNAL / INNEN Ø16-Ø20 BASKI PABUCU / CLAMP / PRATZE
	ACK-07	C-SİSTEM için / For C-SYSTEM / FÜR C-SYSTEM SERAMİK CNGN, SNGN, DNGN YEDEK TAKIMI SPARE PART SET of CERAMIC CNGN, SNGN, DNGN ERSATZTEILSATZ FÜR KERAMIK CNGN, SNGN, DNGN
	ACK-08	C-SİSTEM için / For C-SYSTEM / FÜR C-SYSTEM SERAMİK TNGN, YEDEK TAKIMI SPARE PART SET of CERAMIC TNGN ERSATZTEILSATZ FÜR KERAMIK TNGN
	ACK-09	P-SİSTEM için / For P-SYSTEM / FÜR P-SYSTEM CNMG 16-19, SNMG 15-19 İLAVE BÜYÜK BASKI PABUCU ADDITIONAL BIG CLAMP / ZUSÄTZLICHE GROSSE KLEMME
	ACK-10	C-SİSTEM FREZELEME için / For C-SYSTEM MILLING C-SYSTEM FÜR FRÄSER SPKN 12, Ø50-Ø63 TPKN 16 BASKI PABUCU / CLAMP / PRATZE (M8x8)
	ACK-11	C-SİSTEM FREZELEME için / For C-SYSTEM MILLING C-SYSTEM FÜR FRÄSER Ø80-Ø100 TPKN 16-TPKN 22, OFKR 07, HNMX 09 BASKI PABUCU / CLAMP / PRATZE (M8x10)
	ACK-12	C-SİSTEM için / For C-SYSTEM / FÜR C-SYSTEM CTSPR KARTUŞ BASKI PABUCU / CARTRIDGE CLAMP PRATZE FÜR KASSETTE
	ACK-15	S-SİSTEM FREZELEME için / For S-SYSTEM MILLING S-SYSTEM FÜR FRÄSER RD.. 10-12 BASKI PABUCU / CLAMP / PRATZE
	ACK-19	S-SİSTEM FREZELEME için / For S-SYSTEM MILLING S-SYSTEM FÜR FRÄSER WD0805D BASKI PABUCU / CLAMP / PRATZE
	ACK-21	C-SİSTEM için / For C-SYSTEM / FÜR C-SYSTEM SN.. 1204.. BASKI PABUCU / CLAMP / PRATZE
	ACK-23	C-SİSTEM için / For C-SYSTEM / FÜR C-SYSTEM SERAMİK DNGN 11, YEDEK TAKIMI SPARE PART SET of CERAMIC DNGN 11 ERSATZTEILSATZ FÜR KERAMIK DNGN 11
	ACK-24	S-SİSTEM FREZELEME için / For S-SYSTEM MILLING S-SYSTEM FÜR FRÄSER XD0806D BASKI PABUCU / CLAMP / PRATZE
	ACK-26	C-SİSTEM için / For C-SYSTEM / FÜR C-SYSTEM XNMU 0806.. BASKI PABUCU / CLAMP / PRATZE
	ACK-27	C-SİSTEM için / For C-SYSTEM / FÜR C-SYSTEM RCGX 06 BASKI PABUCU / CLAMP / PRATZE
	ACK-28	C-SİSTEM için / For C-SYSTEM / FÜR C-SYSTEM RCGX 09 BASKI PABUCU / CLAMP / PRATZE
	ACK-29	C-SİSTEM için / For C-SYSTEM / FÜR C-SYSTEM RCGX 12 BASKI PABUCU / CLAMP / PRATZE

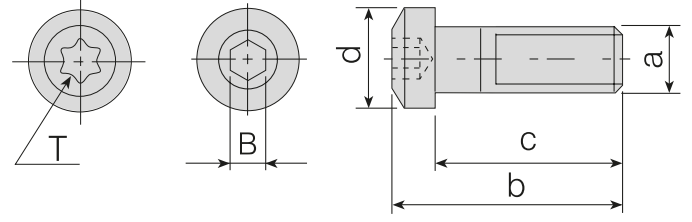

Takım Kodu Ordering Code Bestell-Bezeichnung	BASKI PABUÇ VİDALARI / CLAMP SCREWS / SCHRAUBEN FÜR PRATZEN					Ürün Detayı / Product Detail / Produkt-Details
	a (M)	b	c	d	B(T)	
AKV-01-M5X22	M5x0.8	25.1	22	11	3	T-SİSTEM için / For T-SYSTEM / FÜR T-SYSTEM DNMG 11, WNMG 06, TNMG 16
AKV-02-M6X22	M6x1.0	25.3	22	11	3	T-SİSTEM için / For T-SYSTEM / FÜR T-SYSTEM CNMG 12, WNMG 08, TNMG 22, DNMG 15, SNMG 12, VNMG 16
						M-SİSTEM için / For M-SYSTEM / FÜR M-SYSTEM TNMG 16, TNMG 22
AKV-03-M6X22	M6x1.0	25.3	22	10	3	M-SİSTEM için / For M-SYSTEM / FÜR M-SYSTEM WNMG 08
						KANAL KATERİ için / For EXTERNAL GROOVING FÜR STECHWERKZEUGE 2mm Dış Çap Kanal Kater Vidası / External Grooving Tools Screw 2 mm Schraube für Außen-Stechwerkzeuge
AKV-04-M5X17	M5x0.8	20	17	8.5	3	M-SİSTEM için / For M-SYSTEM / FÜR M-SYSTEM S20R MT-NR/L 16, S20R-S25S MWLNRL 06, S25S MDUNR/L 11-Dış Çap / External / AUBEN MWLNRL 06
AKV-05-M6X25	M6x1.0	29.5	25	13.8	4	T-SİSTEM için / For T-SYSTEM / FÜR T-SYSTEM Eski Ürün Vidası / Old Products Screws / Schraube für altes Produkt CNMG 16, SNMG 15
AKV-06-M6X20	M6x1.0	26.5	20	10.6	4	C-SİSTEM için / For C-SYSTEM / FÜR C-SYSTEM KNUX 16
AKV-07-M6X22	M6x1.0	23.5	22	8.5	3	C-SİSTEM için / For C-SYSTEM / FÜR C-SYSTEM ADKT-154.91, AIKT-154.91-R/L-32
AKV-10-M6X14	M6x1.0	16	14	8.8	4	C-SİSTEM için / For C-SYSTEM / FÜR C-SYSTEM AIKT-154.91-R/L-16, AIKT-154.91-R/L-20, AIKT-154.91-R/L-25
AKV-11-M8X29	M8x1.25	33.6	29	11	4	C-SİSTEM için / For C-SYSTEM / FÜR C-SYSTEM TNGN 16, CNGN 12, DNGN 15, SNGN 12
AKV-17-M5X15	M5x0.8	18	15	8.55	3	M-SİSTEM için / For M-SYSTEM / FÜR M-SYSTEM S16P MWLNRL 06
AKV-19-M7X25	M7x1.0	29.6	25	14	4	T-SİSTEM için / For T-SYSTEM / FÜR T-SYSTEM Yeni / New / Neu CNMG 16, SNMG 15
AKV-20-M6X19	M6x1.0	22	19	11	3	M-SİSTEM için / For M-SYSTEM / FÜR M-SYSTEM S25S MDUNR/L 15
AKV-21-M6X18	M6x1.0	20	18	8.5	3	C-SİSTEM için / For C-SYSTEM / FÜR C-SYSTEM AIKT-154.91-R/L-25
AKV-23-M4X10	M4x0.7	12.2	10	7.4	15	KARTUŞ için / For CARTRIDGE/ FÜR KASSETTE MONTAJ VİDASI / MOUNTING SCREW / BEFESTIGUNGSSCHRAUBE
AKV-27-M6X20	M6x1.0	23.3	20	10	3	M-SİSTEM için / For M-SYSTEM / FÜR M-SYSTEM S25S MWLNRL 08

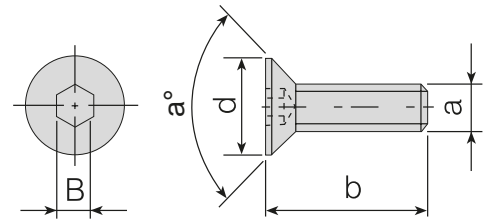

Takım Kodu Ordering Code Bestell-Bezeichnung	ALTLIK VİDALARI / SHIM SCREWS / SCHRAUBE FÜR UNTERLAGE					Ürün Detayı / Product Detail / Produkt-Details
	a (M)	b	d	B	a°	
AAV-01-M3x10	M3x0.5	10	5.9	2	90°	T-SİSTEM için / For T-SYSTEM / FÜR T-SYSTEM WNMG 06, KNUX 16
AAV-02-M5X12	M5x0.8	12	7	3	56°	T-SİSTEM için / For T-SYSTEM / FÜR T-SYSTEM CNMG 12, WNMG 08, TNMG 22, DNMG 15, SNMG 12
AAV-05-M6X15	M6x1.0	16	9	4	60°	T-SİSTEM için / For T-SYSTEM / FÜR T-SYSTEM CNMG 16, SNMG 15
AKV-12-M5X12	M5x0.8	12	7.8	3	90°	C-SİSTEM için / For C-SYSTEM / FÜR C-SYSTEM CTSPR Baskı Pabuç Vidası / Clamp Screw / Klemmschraube
AKV-16-M6X16	M6x1.0	16	10	4	76°	C-SİSTEM için / For C-SYSTEM / FÜR C-SYSTEM CTFPR 13CS 16 Baskı Pabuç Vidası / Clamp Screw / Klemmschraube
AAV-13-M5X8	M5x0.8	8	7	3	56°	T-SİSTEM için / For T-SYSTEM / FÜR T-SYSTEM S25S TSKNR/L 12, S25S TCLNR/L 12, S25S TWLNR/L 08, S25S TDUNR/L 15
AAV-14-M5X14	M5x0.8	14	8.8	3	45°	ADCR için / For ADCR / FÜR ADCR ADCR Montaj Vidası / Mounting Screw / ADCR BEFESTIGUNGSSCHRAUBE

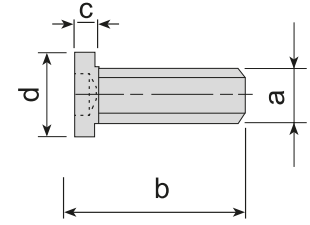
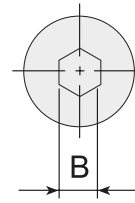

ALTİK VİDALARI / SHIM SCREWS / SCHRAUBE FÜR UNTERLAGE

Takım Kodu Ordering Code Bestell-Bezeichnung	a (M)	b	c	d	B	Ürün Detayı / Product Detail / Produkt-Details	
						T-SİSTEM için / For T-SYSTEM / FÜR T-SYSTEM	C-SİSTEM için / For C-SYSTEM / FÜR C-SYSTEM
AAV-03-M5X12	M5X0.8	12	1.4	6	3	TNMG 16	TNGN 16
AAV-04-M5X12	M5X0.8	12	1.2	6.5	3	VNMG 16, DNMG 11, CNMG 09	
AAV-09-M5X9	M5X0.8	9	1.4	6	3	S25S TCLNR/L 09, S25S TDUNR/L 11, S25S TDQNR/L 11	

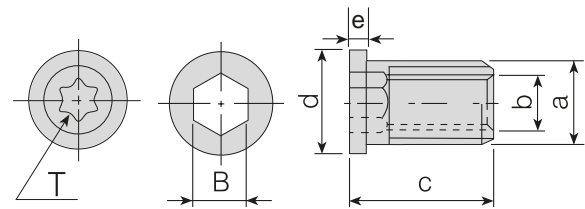

BUKSE VİDALAR / BUKSE SCREWS / SCHRAUBE FÜR UNTERLAGE

Takım Kodu Ordering Code Bestell-Bezeichnung	a (M)	b	c	d	B(T)	e	Ürün Detayı / Product Detail / Produkt-Details	
							S-SİSTEM için / For S-SYSTEM / FÜR S-SYSTEM	
AAV-06-M3.5X11	M5x0.5	M3.5x0.6	11.3	6	3.5	1.2	S-SİSTEM için / For S-SYSTEM / FÜR S-SYSTEM	CCMT 09, DCMT 11, VBMT 16, VCMT 16, TCMT 16, SCMT 09, 16 ER/L, 16 IR/L
AAV-07-M4.5X13	M6X0.75	M4.5X0.75	13	7.5	4.5	1.6	S-SİSTEM için / For S-SYSTEM / FÜR S-SYSTEM	CCMT 12, SCMT 12, 22 ER/L, 22 IR/L
AAV-08-M3.5X8	M5X0.5	M3.5X0.6	8	6	20	1.2	S-SİSTEM için / For S-SYSTEM / FÜR S-SYSTEM	Ø25 DCMT 11, Ø25-Ø32 CCMT 09, Ø25 TCMT 16, S25S-S32T SVJBR/L 16,
AAV-10-M4.5X8	M6X0.75	M4.5X0.75	8	7.5	4.5	1.05	S-SİSTEM için / For S-SYSTEM / FÜR S-SYSTEM	Ø25-Ø32 CCMT 12, Ø25-Ø32 SCMT 12, SSDCN 1616 H12, SSSCR/L 1616 H12, SIR/L S25R 22
AAV-16-M3.5X8	M5X0.5	M3.5X0.6	8	6	20	1.1	S-SİSTEM için / For S-SYSTEM / FÜR S-SYSTEM	SEMT 13

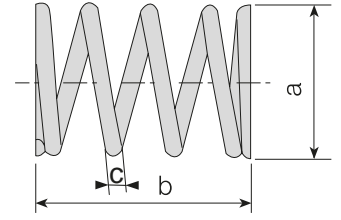
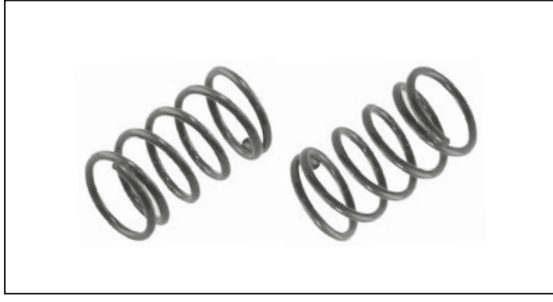

BASKI YAYI / CLAMP SPRING / FEDER FÜR KLEMME						
Takım Kodu Ordering Code Bestell-Bezeichnung	a	b	c	Ürün Detayı / Product Detail / Produkt-Details		
				AKY-01	7.7	11.2
AKY-02	8.5	13.5	0.7	C-SİSTEM için / For C-SYSTEM / FÜR C-SYSTEM	KNUX 16	

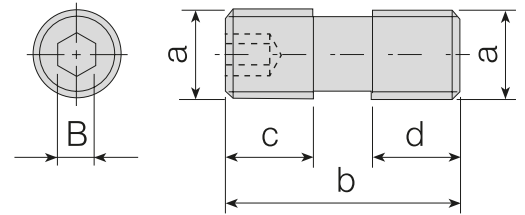

BASKI PABUÇ VIDALARI / CLAMP SCREWS / SCHRAUBEN FÜR PRATZEN							
Takım Kodu Ordering Code Bestell-Bezeichnung	a (M)	b	c	d	B	Ürün Detayı / Product Detail / Produkt-Details	
						AKV-13-M8X1X16	M8x1.0
AKV-14-M8X1X18	M8x1.0	18	8	8	4	C-SİSTEM FREZELEME için / MILLING For C- SYSTEM / C-SYSTEM FÜR FRÄSER	Ø80-Ø100 TPKN 16, Ø63-Ø315 TPKN 22
AKV-15-M8X1X20	M8x1.0	20	8.5	8.5	4	C-SİSTEM FREZELEME için / MILLING For C- SYSTEM / C-SYSTEM FÜR FRÄSER	OFKR 07, HNMX 09
AKV-18-M5X14	M5x0.8	15	5	6.8	2.5	C-SİSTEM FREZELEME için / MILLING For C- SYSTEM / C-SYSTEM FÜR FRÄSER	SN19
AKV-22-M8X1X14	M8x1.0	14	6.8	4.8	4	C-SİSTEM FREZELEME için / MILLING For C- SYSTEM / C-SYSTEM FÜR FRÄSER	Ø50 TPKN 16
AKV-24-M6X1X18	M6x1.0	18	7.5	7.5	3	C-SİSTEM FREZELEME için / MILLING For C- SYSTEM / C-SYSTEM FÜR FRÄSER	SN.. 1204
AKV-26-M6X0.75X20	M6x0.75	20	8.5	8.5	3	C-SİSTEM FREZELEME için / MILLING For C- SYSTEM / C-SYSTEM FÜR FRÄSER	AFM45C-XN0806

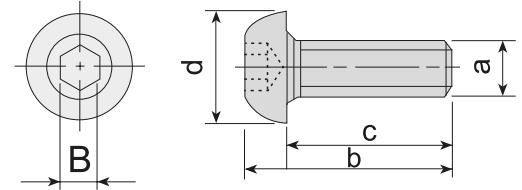

KANAL KATER ve MANTAR VİDALAR / GROOVING TOOL and CLAMP SCREWS / KLEMMSCHRAUBEN

Takım Kodu Ordering Code Bestell-Bezeichnung	a (M)	b	c	d	B	Ürün Detayı / Product Detail / Produkt-Details
1904-M8X1X20	M8X1.0	25.9	20	11.3	4	S-SİSTEM için / For S-SYSTEM / FÜR S-SYSTEM RCMT 32 Sıkma Vidası / Clamp Screw / Klemmschraube
2004-M8X1X20	M8X1.0	25.9	20	11.4	4	KANAL KATERİ için / For EXTERNAL GROOVING / FÜR TNMG-16, TNMG-22 BOHRSTANGE Kanal Kater Vidası / External Grooving Tools Screw / SCHRAUBEN FÜR STECHHALTER
2004-M8X20	M8X1.25	30	25	25	4	KANAL KATERİ için / For EXTERNAL GROOVING / FÜR TNMG-16, TNMG-22 BOHRSTANGE Eski Kanal Kater Vidası / Old External Grooving Tools Screw Alte / Schraube für Stechhalter
AKV-08-M6X12	M6x1.0	17	12	14.3	4	C-SİSTEM FREZELEMİ için / MILLING For C-SYSTEM / C-SYSTEM FÜR FRÄSER Baskı ve Sıkma Vidası, Mantar Vida / Clamp Screw / Klemmschraube
AKV-09-M8X18	M8X1.0	24	18	17.2	5	C-SİSTEM FREZELEMİ için / MILLING For C-SYSTEM / C-SYSTEM FÜR FRÄSER Baskı ve Sıkma Vidası, Mantar Vida / Clamp Screw / Klemmschraube

LEVYELER / LEVERS / KNIEHEBEL

Ürün Resmi Product Picture Produkt-Bild	Ürün Kodu Product Code / Code	Ürün Detayı / Product Detail / Produkt-Details
	APL-01	P-SİSTEM için / For P-SYSTEM / FÜR P-SYSTEM CNMG 09, DNMG 11, SNMG 09, TNMG 16, WNMG 06 LEVYESİ / LEVER / KNIEHEBEL
	APL-02	P-SİSTEM için / For P-SYSTEM / FÜR P-SYSTEM CNMG 12, SNMG 12, TNMG 22, WNMG 08 LEVYESİ / LEVER / KNIEHEBEL
	APL-03	P-SİSTEM için / For P-SYSTEM / FÜR P-SYSTEM DNMG 15 LEVYESİ / LEVER / KNIEHEBEL
	APL-04	P-SİSTEM için / For P-SYSTEM / FÜR P-SYSTEM CNMG 16, SNMG 15 LEVYESİ / LEVER / KNIEHEBEL
	APL-05	P-SİSTEM için / For P-SYSTEM / FÜR P-SYSTEM CNMG 19, SNMG 19 LEVYESİ / LEVER / KNIEHEBEL
	APL-06	P-SİSTEM için / For P-SYSTEM / FÜR P-SYSTEM CNMG 25, SNMG 25 LEVYESİ / LEVER / KNIEHEBEL
	APL-07	P-SİSTEM için / For P-SYSTEM / FÜR P-SYSTEM S16P PCLNR/L 09 LEVYESİ / LEVER / KNIEHEBEL
	APL-08	P-SİSTEM için / For P-SYSTEM / FÜR P-SYSTEM S16P PTUNR/L 16 LEVYESİ / LEVER / KNIEHEBEL

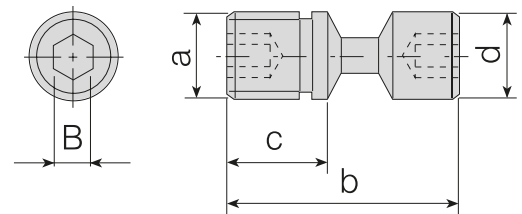
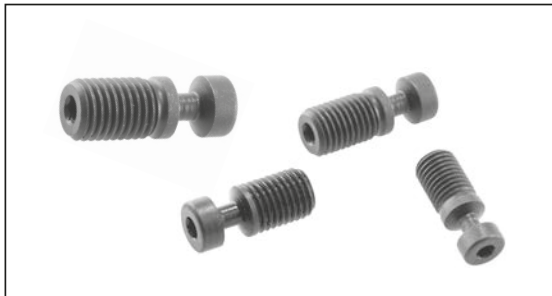

LEVYE VİDALARI / LEVER SCREWS / SCHRAUBEN FÜR KNIEHEBEL

Takım Kodu Ordering Code Bestell-Bezeichnung	a (M)	b	c	d	B	Ürün Detayı / Product Detail / Produkt-Details
ALV-01-M6X14	M6x1.0	14	10	5.85	2.5	P-SİSTEM için / For P-SYSTEM / FÜR P-SYSTEM S20R PCLNR/L 09, S20R PDUNR/L 11, S20R PDQNR/L 11, S20R PWNLR/L 06, S20R PTUNR/L 16
ALV-02-M6X17	M6x1.0	17	10	5.85	2.5	P-SİSTEM için / For P-SYSTEM / FÜR P-SYSTEM CNMG 09, DNMG 11, SNMG 09, TNMG 16, WNMG 06
ALV-03-M8X19	M8X1.0	19.8	11	7.9	3	P-SİSTEM için / For P-SYSTEM / FÜR P-SYSTEM CNMG 12, SNMG 12, TNMG 22, WNMG 08, DNMG 15
ALV-04-M8X22	M8X1.0	21.5	13	7.75	3	P-SİSTEM için / For P-SYSTEM / FÜR P-SYSTEM CNMG 16, SNMG 15
ALV-05-M10X27	M10X1.0	27.5	15	9.9	4	P-SİSTEM için / For P-SYSTEM / FÜR P-SYSTEM CNMG 19, SNMG 19
ALV-06-M12X36	M12X1.0	36	20	12	5	P-SİSTEM için / For P-SYSTEM / FÜR P-SYSTEM CNMG 25, SNMG 25
ALV-07-M6X13	M6X0.1	12.6	6.5	5.9	2.5	P-SİSTEM için / For P-SYSTEM / FÜR P-SYSTEM S16P PCLNR/L 09, S16P PTUNR/L 16
ALV-08-M8X16	M8X1.0	16	10	7.9	3	P-SİSTEM için / For P-SYSTEM / FÜR P-SYSTEM S25S PCLNR/L 12, S25S PDUNR/L 15, S25S PSKNR/L 12

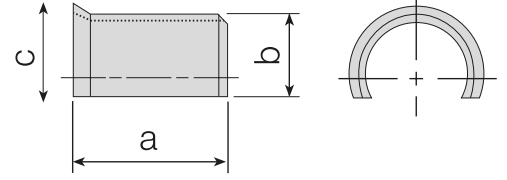
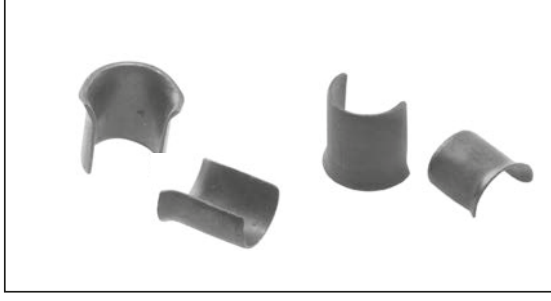

Takım Kodu Ordering Code Bestell-Bezeichnung	ALTLIK YAYLARI / SHIM SPRINGS / BEFESTIGUNGSFEDER				
	a	b	c	Ürün Detayı / Product Detail / Produkt-Details	
AA-Y-01	5.6	4.9	6	P-SİSTEM için / For P-SYSTEM / FÜR P-SYSTEM CNMG 09 ,DNMG 11, SNMG 09, TNMG 16, WNMG 06	
AA-Y-02	6	6.9	7.9	P-SİSTEM için / For P-SYSTEM / FÜR P-SYSTEM CNMG 12, SNMG 12, TNMG 22, WNMG 08, DNMG 15	
AA-Y-03	8.9	8	9.5	P-SİSTEM için / For P-SYSTEM / FÜR P-SYSTEM CNMG 16, SNMG 15	
AA-Y-04	11	9.8	10.7	P-SİSTEM için / For P-SYSTEM / FÜR P-SYSTEM CNMG 19, SNMG 19	
AA-Y-05	12	13	15	P-SİSTEM için / For P-SYSTEM / FÜR P-SYSTEM CNMG 25, SNMG 25	

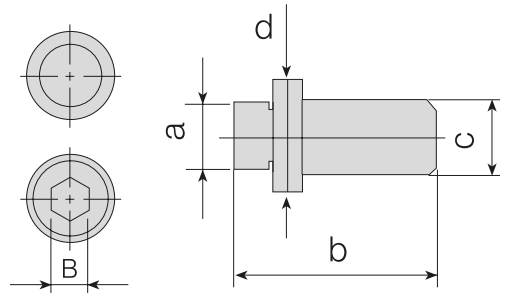
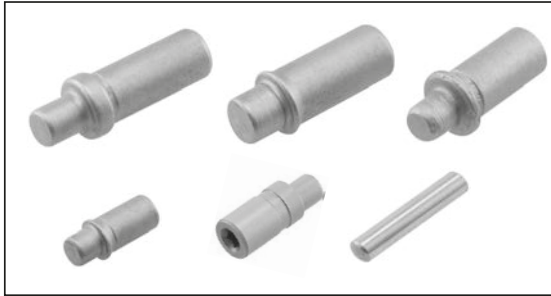

Takım Kodu Ordering Code Bestell-Bezeichnung	PİMLER / PINS / STIFT					
	a	b	c	d	B	Ürün Detayı / Product Detail / Produkt-Details
APM-01	3.55	18	5	6	-	Delik İçi / Internal / Intern Ø32-Ø40 TNMG 16 Dış Çap / External / Externe TNMG 16
APM-02	5	18	6	7.3	-	TNMG 22, WNMG 08
APM-03	3.5	12	5	6.5	-	S20R MTFNR/L 16, S20R MT-NR/L 16, S20R MTUNR/L 16, S20R MTQNR/L 16, S20R MDUNR/L 11
APM-04	5	15	6	7.3	-	S32T MCLNR/L 12, DNMG 15, S25S MWLNR/L 08
APM-05	5	11.5	6.5	6.5	3	MSYNR 11.5CS 12 Kartuş için / for Cartridge / FÜR KASSETTE
APM-06	3	15.7	-	-	-	C-SİSTEM için / For C-SYSTEM / FÜR T-SYSTEM 154.91
APM-07	3.5	11.5	6.5	6.5	3	M-SİSTEM için / For M-SYSTEM / FÜR T-SYSTEM S20R ET-NR 16
APM-08	3.5	12	5	5.4	-	M-SİSTEM için / For M-SYSTEM / FÜR T-SYSTEM S25S MWLNR/L 06, Dış Çap / External / Externe
APM-09	3.5	10	5	5.4	-	M-SİSTEM için / For M-SYSTEM / FÜR T-SYSTEM S16P MWLNR/L 06
APM-10	3.5	11	5	5.4	-	M-SİSTEM için / For M-SYSTEM / FÜR T-SYSTEM S20R MWLNR/L 06
APM-11	3.5	11	5	6.5	-	M-SİSTEM için / For M-SYSTEM / FÜR T-SYSTEM S20R MTQNR/L 16
APM-12	5	12	6	7.3	-	M-SİSTEM için / For M-SYSTEM / FÜR T-SYSTEM S20R MCLNR/L 12, S25S MCLNR/L 12-Z
APM-13	5	14	6	7.3	-	M-SİSTEM için / For M-SYSTEM / FÜR T-SYSTEM S25S MCLNR/L 12
APM-14	3.55	15	5	6	-	M-SİSTEM için / For M-SYSTEM / FÜR T-SYSTEM S25S MTFNR/L 16, S25S MT-NR/L 16, S25S MTUNR/L 16, S25S MTQNR/L 16
APM-15	4.40	16	6.40	6.40	3	M-SİSTEM için / For M-SYSTEM / FÜR T-SYSTEM MSYNR 16CS 12 Kartuş için / for Cartridge / FÜR KASSETTE

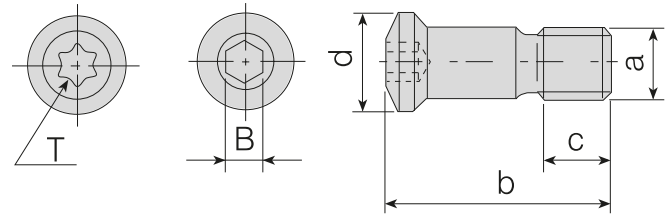

KÜRESEL FİNİŞ VİDALARI / BALL NOSE SCREWS / SCHRAUBEN FÜR KUGELKOPFFRÄSER

Takım Kodu Ordering Code Bestell-Bezeichnung	a (M)	b	c	d	B(T)	Ürün Detayı / Product Detail / Produkt-Details
1208-M3x7	M3x0.5	6.9	2.7	4.1	8	KÜRESEL FREZE VİDASI / BALL NOSE SCREW / SCHRAUBE FÜR KUGELFRÄSER P3208
1215-M4X0.5X9	M4X0.5	8.6	3.2	5.75	15	KÜRESEL FREZE VİDASI / BALL NOSE SCREW / SCHRAUBE FÜR KUGELFRÄSER P3210-ROHX 12
1220-M5X0.5X9	M5X0.5	9.6	3.4	6.8	20	KÜRESEL FREZE VİDASI / BALL NOSE SCREW / SCHRAUBE FÜR KUGELFRÄSER P3212
1220-M5X0.5X12	M5X0.5	12.9	4.4	7.4	20	KÜRESEL FREZE VİDASI / BALL NOSE SCREW / SCHRAUBE FÜR KUGELFRÄSER P3216-ROHX 16
1220-M5X0.5X15	M5X0.5	16.4	6	7.8	20	KÜRESEL FREZE VİDASI / BALL NOSE SCREW / SCHRAUBE FÜR KUGELFRÄSER P3220-ROHX 20
1220-M6X0.75X20	M6X0.75	20	6	9.4	20	KÜRESEL FREZE VİDASI / BALL NOSE SCREW / SCHRAUBE FÜR KUGELFRÄSER P3225
1204-M8X0.75X26	M8X0.75	26	7.5	12	4	KÜRESEL FREZE VİDASI / BALL NOSE SCREW / SCHRAUBE FÜR KUGELFRÄSER P3232
1210-M3.5X9.6	M3.5X0.6	9.6	4	4.7	10	KÜRESEL FREZE VİDASI / BALL NOSE SCREW / SCHRAUBE FÜR KUGELFRÄSER BNM 12
1215-M4X13.5	M4X0.7	13.5	5	5.8	15	KÜRESEL FREZE VİDASI / BALL NOSE SCREW / SCHRAUBE FÜR KUGELFRÄSER BNM 16

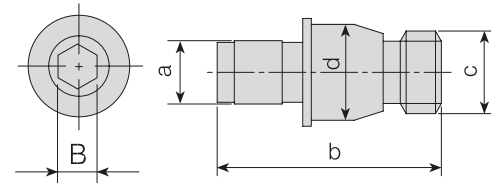
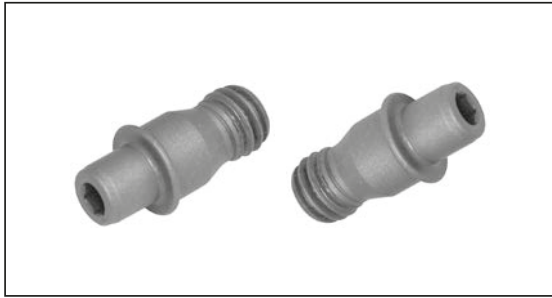

EKSANTRİK VİDA / ECCENTRIC SCREW / EXZENTERSCHRAUBEN

Takım Kodu Ordering Code Bestell-Bezeichnung	a	b	c	d	B	Ürün Detayı / Product Detail / Produkt-Details
AEV-01-M6x16	4.85	16	M6x1.0	6.5	2.5	Eksantrik Vida / Eccentric Screw / EXZENTERSCHRAUBEN PSDNN Kartuş için / for Cartridge / FÜR KASSETTE

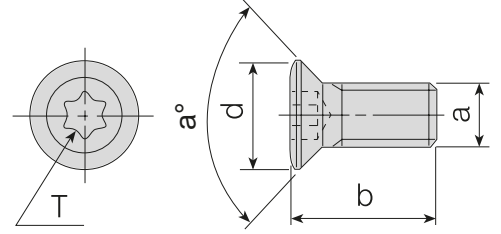

TORK VİDALARI / TORX SCREWS / TORX-SCHRAUBEN

Takım Kodu Ordering Code Bestell-Bezeichnung	a (M)	b	T	d	a°	Ürün Detayı / Product Detail / Produkt-Details	
4006-M1.6x3.2	M1.6X0.35	3.2	6	2.50	60	S-SİSTEM için / For S-SYSTEM / FÜR S-SYSTEM	TORK VİDA / TORX SCREW / TORX-SCHRAUBEN
3006-M1.8x4	M1.8X0.35	4	6	2.45	60	S-SİSTEM için / For S-SYSTEM / FÜR S-SYSTEM	TORK VİDA / TORX SCREW / TORX-SCHRAUBEN
3006-M2x4	M2X0.4	4.3	6	2.7	60	S-SİSTEM için / For S-SYSTEM / FÜR S-SYSTEM	TORK VİDA / TORX SCREW / TORX-SCHRAUBEN
4006-M2x5	M2X0.4	5	6	3	55	S-SİSTEM için / For S-SYSTEM / FÜR S-SYSTEM	TORK VİDA / TORX SCREW / TORX-SCHRAUBEN
3007-M2.2x5	M2.2X0.45	5.2	7	3.15	60	S-SİSTEM için / For S-SYSTEM / FÜR S-SYSTEM	TORK VİDA / TORX SCREW / TORX-SCHRAUBEN
4006-M2.2x5	M2.2X0.45	5	6	2.8	55	S-SİSTEM için / For S-SYSTEM / FÜR S-SYSTEM	TORK VİDA / TORX SCREW / TORX-SCHRAUBEN
1008-M2.5x5	M2.5X0.45	5.5	8	3.5	45	S-SİSTEM için / For S-SYSTEM / FÜR S-SYSTEM	TORK VİDA / TORX SCREW / TORX-SCHRAUBEN
1008-M2.5x7	M2.5X0.45	7	8	3.6	45	S-SİSTEM için / For S-SYSTEM / FÜR S-SYSTEM	TORK VİDA / TORX SCREW / TORX-SCHRAUBEN
1108-M2.5x6	M2.5X0.45	6	8	3.9	R	S-SİSTEM için / For S-SYSTEM / FÜR S-SYSTEM	TORK VİDA / TORX SCREW / TORX-SCHRAUBEN
3008-M2.5x5	M2.5X0.45	5	8	3.5	60	S-SİSTEM için / For S-SYSTEM / FÜR S-SYSTEM	TORK VİDA / TORX SCREW / TORX-SCHRAUBEN
3008-M2.5x6	M2.5X0.45	6	8	3.5	60	S-SİSTEM için / For S-SYSTEM / FÜR S-SYSTEM	TORK VİDA / TORX SCREW / TORX-SCHRAUBEN
4008-M2.5x4	M2.5X0.45	4	8	3.5	45	S-SİSTEM için / For S-SYSTEM / FÜR S-SYSTEM	TORK VİDA / TORX SCREW / TORX-SCHRAUBEN
4008-M2.5x4.5	M2.5X0.45	4.5	8	3.5	45	S-SİSTEM için / For S-SYSTEM / FÜR S-SYSTEM	TORK VİDA / TORX SCREW / TORX-SCHRAUBEN
4008-M2.5x6	M2.5X0.45	5.8	8	3.5	45	S-SİSTEM için / For S-SYSTEM / FÜR S-SYSTEM	TORK VİDA / TORX SCREW / TORX-SCHRAUBEN
4008-M2.5x6.5	M2.5X0.45	6.5	8	4	60	S-SİSTEM için / For S-SYSTEM / FÜR S-SYSTEM	TORK VİDA / TORX SCREW / TORX-SCHRAUBEN
4108-M2.5x6.5	M2.5X0.45	6.5	8	3.5	50	S-SİSTEM için / For S-SYSTEM / FÜR S-SYSTEM	TORK VİDA / TORX SCREW / TORX-SCHRAUBEN
4108-M2.5x8	M2.5X0.45	8	8	3.5	50	S-SİSTEM için / For S-SYSTEM / FÜR S-SYSTEM	TORK VİDA / TORX SCREW / TORX-SCHRAUBEN
1008-M3x6	M3X0.5	6	8	4	60	S-SİSTEM için / For S-SYSTEM / FÜR S-SYSTEM	TORK VİDA / TORX SCREW / TORX-SCHRAUBEN
1008-M3x8	M3X0.5	8	8	3.9	60	S-SİSTEM için / For S-SYSTEM / FÜR S-SYSTEM	TORK VİDA / TORX SCREW / TORX-SCHRAUBEN
1108-M3x6.8	M3X0.5	6.8	8	4	60	S-SİSTEM için / For S-SYSTEM / FÜR S-SYSTEM	TORK VİDA / TORX SCREW / TORX-SCHRAUBEN
3008-M3x6	M3X0.5	6	8	4	45	S-SİSTEM için / For S-SYSTEM / FÜR S-SYSTEM	TORK VİDA / TORX SCREW / TORX-SCHRAUBEN
3008-M3x7	M3X0.5	7	8	4	55	S-SİSTEM için / For S-SYSTEM / FÜR S-SYSTEM	TORK VİDA / TORX SCREW / TORX-SCHRAUBEN
3008-M3x8	M3X0.5	8	8	4	45	S-SİSTEM için / For S-SYSTEM / FÜR S-SYSTEM	TORK VİDA / TORX SCREW / TORX-SCHRAUBEN
3108-M3x6	M3X0.5	6	8	3.8	60	S-SİSTEM için / For S-SYSTEM / FÜR S-SYSTEM	TORK VİDA / TORX SCREW / TORX-SCHRAUBEN
3108-M3x8	M3X0.5	8	8	3.8	60	S-SİSTEM için / For S-SYSTEM / FÜR S-SYSTEM	TORK VİDA / TORX SCREW / TORX-SCHRAUBEN
4008-M3x8	M3X0.5	8	8	4	60	S-SİSTEM için / For S-SYSTEM / FÜR S-SYSTEM	TORK VİDA / TORX SCREW / TORX-SCHRAUBEN
4010-M3x6	M3X0.5	6	10	4.2	45	S-SİSTEM için / For S-SYSTEM / FÜR S-SYSTEM	TORK VİDA / TORX SCREW / TORX-SCHRAUBEN
4010-M3x8	M3X0.5	8	10	4.2	45	S-SİSTEM için / For S-SYSTEM / FÜR S-SYSTEM	TORK VİDA / TORX SCREW / TORX-SCHRAUBEN
1015-M3.5x9	M3.5X0.6	9	15	5.3	60	S-SİSTEM için / For S-SYSTEM / FÜR S-SYSTEM	TORK VİDA / TORX SCREW / TORX-SCHRAUBEN
1015-M3.5x11	M3.5X0.6	11.1	15	5.3	60	S-SİSTEM için / For S-SYSTEM / FÜR S-SYSTEM	TORK VİDA / TORX SCREW / TORX-SCHRAUBEN
1015-M3.5x14	M3.5X0.6	14	15	5.3	66	S-SİSTEM için / For S-SYSTEM / FÜR S-SYSTEM	TORK VİDA / TORX SCREW / TORX-SCHRAUBEN
1015-M3.5x16	M3.5X0.6	16	15	5.3	55	S-SİSTEM için / For S-SYSTEM / FÜR S-SYSTEM	TORK VİDA / TORX SCREW / TORX-SCHRAUBEN
1315-M3.5x11	M3.5X0.6	10.6	15	7.9	-	S-SİSTEM için / For S-SYSTEM / FÜR S-SYSTEM	TORK VİDA / TORX SCREW / TORX-SCHRAUBEN
1510-M3.5x7	M3.5X0.6	7.1	10	5.1	55	S-SİSTEM için / For S-SYSTEM / FÜR S-SYSTEM	TORK VİDA / TORX SCREW / TORX-SCHRAUBEN
1510-M3.5x9	M3.5X0.6	9.1	10	5	55	S-SİSTEM için / For S-SYSTEM / FÜR S-SYSTEM	TORK VİDA / TORX SCREW / TORX-SCHRAUBEN
1615-M3.5x10	M3.5X0.6	10	15	5.8	60	S-SİSTEM için / For S-SYSTEM / FÜR S-SYSTEM	TORK VİDA / TORX SCREW / TORX-SCHRAUBEN
1615-M3.5x11	M3.5X0.6	11	15	5.8	60	S-SİSTEM için / For S-SYSTEM / FÜR S-SYSTEM	TORK VİDA / TORX SCREW / TORX-SCHRAUBEN
1615-M3.5x15	M3.5X0.6	15	15	5.8	60	S-SİSTEM için / For S-SYSTEM / FÜR S-SYSTEM	TORK VİDA / TORX SCREW / TORX-SCHRAUBEN
3010-M3.5x7	M3.5X0.6	7	10	5	55	S-SİSTEM için / For S-SYSTEM / FÜR S-SYSTEM	TORK VİDA / TORX SCREW / TORX-SCHRAUBEN
3010-M3.5x9	M3.5X0.6	9	10	5	55	S-SİSTEM için / For S-SYSTEM / FÜR S-SYSTEM	TORK VİDA / TORX SCREW / TORX-SCHRAUBEN
3015-M3.5x9	M3.5X0.6	8.8	15	5.4	60	S-SİSTEM için / For S-SYSTEM / FÜR S-SYSTEM	TORK VİDA / TORX SCREW / TORX-SCHRAUBEN
4015-M3.5x8	M3.5X0.6	7.9	15	5.3	55	S-SİSTEM için / For S-SYSTEM / FÜR S-SYSTEM	TORK VİDA / TORX SCREW / TORX-SCHRAUBEN
4015-M3.5x9	M3.5X0.6	8.7	15	5.3	60	S-SİSTEM için / For S-SYSTEM / FÜR S-SYSTEM	TORK VİDA / TORX SCREW / TORX-SCHRAUBEN
4015-M3.5x10	M3.5X0.6	9.8	15	5.3	60	S-SİSTEM için / For S-SYSTEM / FÜR S-SYSTEM	TORK VİDA / TORX SCREW / TORX-SCHRAUBEN
4015-M3.5x11	M3.5X0.6	10.7	15	5.3	60	S-SİSTEM için / For S-SYSTEM / FÜR S-SYSTEM	TORK VİDA / TORX SCREW / TORX-SCHRAUBEN

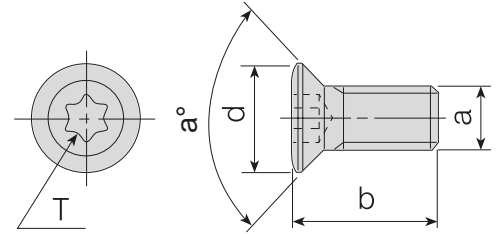
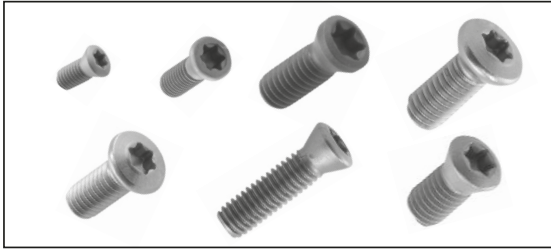

TORK VİDALARI / TORX SCREWS / TORX-SCHRAUBEN

Takım Kodu Ordering Code Bestell-Bezeichnung	a (M)	b	T	d	a°	Ürün Detayı / Product Detail / Produkt-Details	
4015-M3.5x12	M3.5X0.6	12	15	5.3	60	S-SİSTEM için / For S-SYSTEM / FÜR S-SYSTEM	TORK VİDA / TORX SCREW / TORX-SCHRAUBEN
4015-M3.5x14	M3.5X0.6	13.7	15	5.3	60	S-SİSTEM için / For S-SYSTEM / FÜR S-SYSTEM	TORK VİDA / TORX SCREW / TORX-SCHRAUBEN
1015-M4x8	M4X0.7	8	15	6.8	R	S-SİSTEM için / For S-SYSTEM / FÜR S-SYSTEM	TORK VİDA / TORX SCREW / TORX-SCHRAUBEN
1015-M4x9	M4X0.7	9	15	6.8	R	S-SİSTEM için / For S-SYSTEM / FÜR S-SYSTEM	TORK VİDA / TORX SCREW / TORX-SCHRAUBEN
1515-M4x9	M4X0.7	9	15	5.7	50	S-SİSTEM için / For S-SYSTEM / FÜR S-SYSTEM	TORK VİDA / TORX SCREW / TORX-SCHRAUBEN
1015-M4x11	M4X0.7	10.8	15	6.8	R	S-SİSTEM için / For S-SYSTEM / FÜR S-SYSTEM	TORK VİDA / TORX SCREW / TORX-SCHRAUBEN
1115-M4x10	M4X0.7	10	15	5.9	R	S-SİSTEM için / For S-SYSTEM / FÜR S-SYSTEM	TORK VİDA / TORX SCREW / TORX-SCHRAUBEN
1315-M4x11	M4X0.7	11.1	15	5	45	S-SİSTEM için / For S-SYSTEM / FÜR S-SYSTEM	TORK VİDA / TORX SCREW / TORX-SCHRAUBEN
1415-M4x11	M4X0.7	11	15	5.6	50	S-SİSTEM için / For S-SYSTEM / FÜR S-SYSTEM	TORK VİDA / TORX SCREW / TORX-SCHRAUBEN
1515-M4x11	M4X0.7	11.1	15	5.6	50	S-SİSTEM için / For S-SYSTEM / FÜR S-SYSTEM	TORK VİDA / TORX SCREW / TORX-SCHRAUBEN
1615-M4x11	M4X0.7	11.1	15	6	50	S-SİSTEM için / For S-SYSTEM / FÜR S-SYSTEM	TORK VİDA / TORX SCREW / TORX-SCHRAUBEN
3015-M4x9	M4X0.7	9	15	5.6	50	S-SİSTEM için / For S-SYSTEM / FÜR S-SYSTEM	TORK VİDA / TORX SCREW / TORX-SCHRAUBEN
3015-M4x11	M4X0.7	11	15	5.6	50	S-SİSTEM için / For S-SYSTEM / FÜR S-SYSTEM	TORK VİDA / TORX SCREW / TORX-SCHRAUBEN
4015-M4x9	M4X0.7	9	15	5.6	50	S-SİSTEM için / For S-SYSTEM / FÜR S-SYSTEM	TORK VİDA / TORX SCREW / TORX-SCHRAUBEN
4015-M4x10	M4X0.7	10	15	5.6	50	S-SİSTEM için / For S-SYSTEM / FÜR S-SYSTEM	TORK VİDA / TORX SCREW / TORX-SCHRAUBEN
4015-M4x11	M4X0.7	11	15	5.6	50	S-SİSTEM için / For S-SYSTEM / FÜR S-SYSTEM	TORK VİDA / TORX SCREW / TORX-SCHRAUBEN
4015-M4x12	M4X0.7	12	15	5.7	50	S-SİSTEM için / For S-SYSTEM / FÜR S-SYSTEM	TORK VİDA / TORX SCREW / TORX-SCHRAUBEN
4115-M4x12	M4X0.7	12	15	5.6	55	S-SİSTEM için / For S-SYSTEM / FÜR S-SYSTEM	TORK VİDA / TORX SCREW / TORX-SCHRAUBEN
4515-M4x8	M4X0.7	8	15	5.1	50	S-SİSTEM için / For S-SYSTEM / FÜR S-SYSTEM	TORK VİDA / TORX SCREW / TORX-SCHRAUBEN
4515-M4x11	M4X0.7	11	15	5.1	50	S-SİSTEM için / For S-SYSTEM / FÜR S-SYSTEM	TORK VİDA / TORX SCREW / TORX-SCHRAUBEN
4615-M4x11	M4X0.7	11	15	6	50	S-SİSTEM için / For S-SYSTEM / FÜR S-SYSTEM	TORK VİDA / TORX SCREW / TORX-SCHRAUBEN
1015-M4.5x12	M4.5X0.75	12	15	6.6	50	S-SİSTEM için / For S-SYSTEM / FÜR S-SYSTEM	TORK VİDA / TORX SCREW / TORX-SCHRAUBEN
1020-M4.5x14	M4.5X0.75	14	20	6.5	45	S-SİSTEM için / For S-SYSTEM / FÜR S-SYSTEM	TORK VİDA / TORX SCREW / TORX-SCHRAUBEN
1020-M4.5x16	M4.5X0.75	16	20	6.5	45	S-SİSTEM için / For S-SYSTEM / FÜR S-SYSTEM	TORK VİDA / TORX SCREW / TORX-SCHRAUBEN
1120-M4.5x12	M4.5X0.75	12.1	20	7.9	R	S-SİSTEM için / For S-SYSTEM / FÜR S-SYSTEM	TORK VİDA / TORX SCREW / TORX-SCHRAUBEN
1515-M4.5x11	M4.5X0.75	11	15	6.4	45	S-SİSTEM için / For S-SYSTEM / FÜR S-SYSTEM	TORK VİDA / TORX SCREW / TORX-SCHRAUBEN
4015-M4.5x11	M4.5X0.75	11	15	6.4	45	S-SİSTEM için / For S-SYSTEM / FÜR S-SYSTEM	TORK VİDA / TORX SCREW / TORX-SCHRAUBEN
4020-M4.5x10	M4.5X0.75	10	20	6.5	55	S-SİSTEM için / For S-SYSTEM / FÜR S-SYSTEM	TORK VİDA / TORX SCREW / TORX-SCHRAUBEN
4020-M4.5x12	M4.5X0.75	12	20	6.5	55	S-SİSTEM için / For S-SYSTEM / FÜR S-SYSTEM	TORK VİDA / TORX SCREW / TORX-SCHRAUBEN
1020-M5x11	M5X0.8	11	20	6.6	50	S-SİSTEM için / For S-SYSTEM / FÜR S-SYSTEM	TORK VİDA / TORX SCREW / TORX-SCHRAUBEN
1020-M5x14	M5X0.8	14.1	20	6.8	50	S-SİSTEM için / For S-SYSTEM / FÜR S-SYSTEM	TORK VİDA / TORX SCREW / TORX-SCHRAUBEN
1120-M5x13	M5X0.8	13	20	7	R	S-SİSTEM için / For S-SYSTEM / FÜR S-SYSTEM	TORK VİDA / TORX SCREW / TORX-SCHRAUBEN
1615-M5x14	M5X0.8	14	15	7.3	50	S-SİSTEM için / For S-SYSTEM / FÜR S-SYSTEM	TORK VİDA / TORX SCREW / TORX-SCHRAUBEN
1620-M5x18	M5X0.8	18	20	8.15	50	S-SİSTEM için / For S-SYSTEM / FÜR S-SYSTEM	TORK VİDA / TORX SCREW / TORX-SCHRAUBEN
1620-M5x22	M5X0.8	22	20	8.15	50	S-SİSTEM için / For S-SYSTEM / FÜR S-SYSTEM	TORK VİDA / TORX SCREW / TORX-SCHRAUBEN
4420-M5x14	M5X0.8	14	20	6.60	60	S-SİSTEM için / For S-SYSTEM / FÜR S-SYSTEM	TORK VİDA / TORX SCREW / TORX-SCHRAUBEN
1020-M6x16	M6X1.0	16	20	8.5	50	S-SİSTEM için / For S-SYSTEM / FÜR S-SYSTEM	TORK VİDA / TORX SCREW / TORX-SCHRAUBEN
1420-M6x16	M6X1.0	16	20	7.6	50	S-SİSTEM için / For S-SYSTEM / FÜR S-SYSTEM	TORK VİDA / TORX SCREW / TORX-SCHRAUBEN
1520-M6x16	M6X1.0	16	20	8.2	50	S-SİSTEM için / For S-SYSTEM / FÜR S-SYSTEM	TORK VİDA / TORX SCREW / TORX-SCHRAUBEN
1710-U5-40x12.2	UNC 5-40	12.2	10	5.6	60	S-SİSTEM için / For S-SYSTEM / FÜR S-SYSTEM	TORK VİDA / TORX SCREW / TORX-SCHRAUBEN
1720-U8-32x10	UNC 8-32	10	20	7.5	60	S-SİSTEM için / For S-SYSTEM / FÜR S-SYSTEM	TORK VİDA / TORX SCREW / TORX-SCHRAUBEN
1720-U8-32x15	UNC 8-32	15	20	7.5	60	S-SİSTEM için / For S-SYSTEM / FÜR S-SYSTEM	TORK VİDA / TORX SCREW / TORX-SCHRAUBEN
1707-U4-48x6	UNF 4-48	6	7	3.27	60	S-SİSTEM için / For S-SYSTEM / FÜR S-SYSTEM	TORK VİDA / TORX SCREW / TORX-SCHRAUBEN
1707-U4-48x6.5	UNF 4-48	6.5	7	3.27	60	S-SİSTEM için / For S-SYSTEM / FÜR S-SYSTEM	TORK VİDA / TORX SCREW / TORX-SCHRAUBEN
1707-U4-48x8.2	UNF 4-48	8.2	7	3.27	60	S-SİSTEM için / For S-SYSTEM / FÜR S-SYSTEM	TORK VİDA / TORX SCREW / TORX-SCHRAUBEN

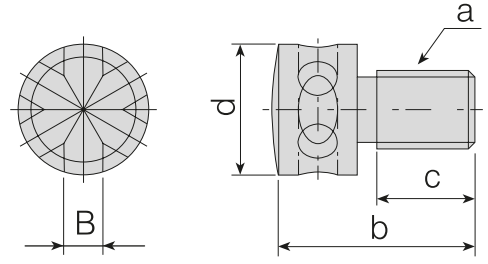

EKSENEL AYAR VİDALARI / AXIAL ADJUSTING SCREWS / AXIAL-EINSTELLSCHRAUBE

Takım Kodu Ordering Code Bestell-Bezeichnung	a (M)	b	c	d	B	Ürün Detayı / Product Detail / Produkt-Detalls	
2600-M4x9.5	M4x0.5	5.5	4	4	1.5	Kartuş için / for Cartridge / FÜR KASSETTE	Eksenel Ayar Vida / Axial Adjust Screw / Axial-Einstellschraube
2600-M5x13	M5x0.5	12.8	7	8.7	2.5	Kartuş için / for Cartridge / FÜR KASSETTE	Eksenel Ayar Vida / Axial Adjust Screw / Axial-Einstellschraube
2600-M6x18	M6x1.0	18.2	9	10	3.5	Kartuş için / for Cartridge / FÜR KASSETTE	Eksenel Ayar Vida / Axial Adjust Screw / Axial-Einstellschraube

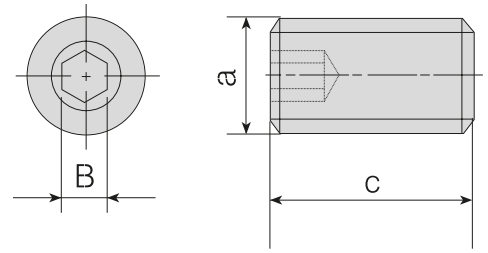

RADYAL AYAR VİDALARI / RADIAL ADJUSTING SCREWS / AXIAL-EINSTELLSCHRAUBE

Takım Kodu Ordering Code Bestell-Bezeichnung	a (M)	c	B	Ürün Detayı / Product Detail / Produkt-Detalls	
2715-M3x4	M3x0.5	4	1.5	KABA BARA için / for ROUGH BORING HEADS FÜR SCHRUPP-SPINDELKOPF	KABA BARA KARTUŞU için / for ROUGH BORING HEADS CARTRIDGE FÜR KASSETTEN DER SCHRUPP-SPINDELKÖPFE
2715-M3x5	M3x0.5	5	1.5	KABA BARA için / for ROUGH BORING HEADS FÜR SCHRUPP-SPINDELKOPF	KABA BARA KARTUŞU için / for ROUGH BORING HEADS CARTRIDGE FÜR KASSETTEN DER SCHRUPP-SPINDELKÖPFE
2715-M3x8	M3x0.5	8	1.5	KABA BARA için / for ROUGH BORING HEADS FÜR SCHRUPP-SPINDELKOPF	KABA BARA KARTUŞU için / for ROUGH BORING HEADS CARTRIDGE FÜR KASSETTEN DER SCHRUPP-SPINDELKÖPFE
2702-M4x4	M4x0.7	4	2	KARTUŞ için / for CARTRIDGE / FÜR KASSETTE	KARTUŞ için / for CARTRIDGE / FÜR KASSETTE
2702-M4x10	M4x0.7	10	2	KARTUŞ için / for CARTRIDGE / FÜR KASSETTE	KARTUŞ için / for CARTRIDGE / FÜR KASSETTE
2702-M4x12	M4x0.7	12	2	KABA BARA için / for ROUGH BORING HEADS FÜR SCHRUPP-SPINDELKOPF	KABA BARA KARTUŞU için / for ROUGH BORING HEADS CARTRIDGE FÜR KASSETTEN DER SCHRUPP-SPINDELKÖPFE
2725-M5x6	M5x0.8	5	2.5	KARTUŞ için / for CARTRIDGE / FÜR KASSETTE	KARTUŞ için / for CARTRIDGE / FÜR KASSETTE
2725-M5x10	M5x0.8	10	2.5	KARTUŞ için / for CARTRIDGE / FÜR KASSETTE	KARTUŞ için / for CARTRIDGE / FÜR KASSETTE
2725-M5x12	M5x0.8	12	2.5	KABA BARA için / for ROUGH BORING HEADS FÜR SCHRUPP-SPINDELKOPF	KABA BARA KARTUŞU için / for ROUGH BORING HEADS CARTRIDGE FÜR KASSETTEN DER SCHRUPP-SPINDELKÖPFE
2725-M5x14	M5x0.8	14	2.5	KABA BARA için / for ROUGH BORING HEADS FÜR SCHRUPP-SPINDELKOPF	KABA BARA KARTUŞU için / for ROUGH BORING HEADS CARTRIDGE FÜR KASSETTEN DER SCHRUPP-SPINDELKÖPFE
2703-M6x16	M6x1	16	3	KABA BARA için / for ROUGH BORING HEADS FÜR SCHRUPP-SPINDELKOPF	KABA BARA KARTUŞU için / for ROUGH BORING HEADS CARTRIDGE FÜR KASSETTEN DER SCHRUPP-SPINDELKÖPFE
2704-M8x25	M8x1.25	25.9	4	KABA BARA için / for ROUGH BORING HEADS FÜR SCHRUPP-SPINDELKOPF	KABA BARA KARTUŞU için / for ROUGH BORING HEADS CARTRIDGE FÜR KASSETTEN DER SCHRUPP-SPINDELKÖPFE

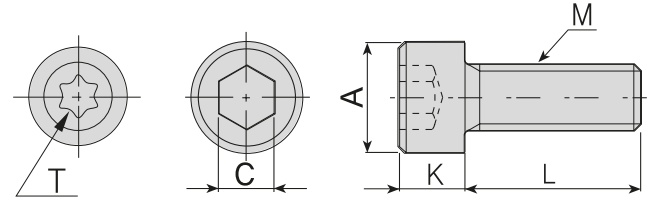

İNBUS CİVATALAR / INBUS SCREWS / INNENSECHSKANT-SCHRAUBE

Takım Kodu Ordering Code Bestell-Bezeichnung	M A C K L					Ürün Detayı / Product Detail / Produkt-Details	
	2503-M4x10	M4x0.7	6.85	3	4	10	KANAL KATER VİDASI / SOME GROOVING TOOLS SCREW
2525-M3X14	M3X0.5	5.4	2.5	2.9	14	BARA KARTUŞU için SIKMA VİDASI / for BORING HEADS CARTRIDGE SCREW	SCHRAUBE FÜR KASSETTE DER SCHRUPP-SPINDELKÖPFE
2503-M4X20	M4x0.7	7	3	3.9	20	BARA KARTUŞU için SIKMA VİDASI / for BORING HEADS CARTRIDGE SCREW	SCHRAUBE FÜR KASSETTE DER SCHRUPP-SPINDELKÖPFE
2503-M4X12	M4x0.7	6.85	3	4	12	KANAL KATER VİDASI / SOME GROOVING TOOLS SCREW	SCHRAUBEN FÜR STECHHALTER
2503-M4X15	M4x0.7	6.85	3	4	15	BARA KARTUŞU için SIKMA VİDASI / for BORING HEADS CARTRIDGE SCREW	SCHRAUBE FÜR KASSETTE DER SCHRUPP-SPINDELKÖPFE
2504-M5X16	M5X0.8	8.5	4	5	16	KANAL KATER VİDASI / SOME GROOVING TOOLS SCREW	SCHRAUBEN FÜR STECHHALTER
2504-M5X12	M5X0.8	8.5	4	5	12	KANAL KATER VİDASI / SOME GROOVING TOOLS SCREW	SCHRAUBEN FÜR STECHHALTER
2504-M5X25	M5X0.8	8.5	4	5	25	BARA KARTUŞU için SIKMA VİDASI / for BORING HEADS CARTRIDGE SCREW	SCHRAUBE FÜR KASSETTE DER SCHRUPP-SPINDELKÖPFE
2505-M6X16	M6X1	9.9	5	6	16	KANAL KATER VİDASI / SOME GROOVING TOOLS SCREW	SCHRAUBEN FÜR STECHHALTER
2505-M6X20	M6X1	9.9	5	6	20	KANAL KATER VİDASI / SOME GROOVING TOOLS SCREW	SCHRAUBEN FÜR STECHHALTER
2505-M6X25	M6X1	9.9	5	6	25	BLOK BASKI PABUÇ VİDASI / for BLOCK CLAMP SCREW	SCHRAUBE FÜR SPANNBLOCK
2505-M6X30	M6X1	9.9	5	6	30	BARA KARTUŞU için SIKMA VİDASI / for BORING HEADS CARTRIDGE SCREW	SCHRAUBE FÜR KASSETTE DER SCHRUPP-SPINDELKÖPFE
2405-M8X30	M8X1.25	13	5	5	30	A16 MONTAJ VİDASI (KAFASI KÜÇÜK) / MOUNTING SCREW (SMALL HEAD)	BEFESTIGUNGSSCHRAUBE (KLEINER KOPF)
2506-M8X20	M8X1.25	13	6	7.9	20	KARTUŞ MONTAJ VİDASI / CARTRIDGE MOUNTING SCREW	BEFESTIGUNGSSCHRAUBE FÜR KASSETTE
2506-M8X30	M8X1.25	13	6	7.9	30	A16 MONTAJ VİDASI / MOUNTING SCREW	BEFESTIGUNGSSCHRAUBE
2506-M8X35	M8X1.25	13	6	7.9	35	BARA KARTUŞU için SIKMA VİDASI / for BORING HEADS CARTRIDGE SCREW	SCHRAUBE FÜR KASSETTE DER SCHRUPP-SPINDELKÖPFE
2406-M8X30	M8X1.25	12	6	7.9	30	A16 MONTAJ VİDASI / MOUNTING SCREW	BEFESTIGUNGSSCHRAUBE
2407-M10X30	M10X1.5	16	7	6	30	A16 MONTAJ VİDASI / MOUNTING SCREW	BEFESTIGUNGSSCHRAUBE
2408-M10X30	M10X1.5	13.90	8	10	30	A22 MONTAJ VİDASI / MOUNTING SCREW	BEFESTIGUNGSSCHRAUBE
2508-M10X30	M10X1.5	16	8	10	30	A22 MONTAJ VİDASI / MOUNTING SCREW	BEFESTIGUNGSSCHRAUBE
2508-M10X40	M10X1.5	16	8	10	40	BARA KARTUŞU için SIKMA VİDASI / for BORING HEADS CARTRIDGE SCREWS	SCHRAUBE FÜR KASSETTE DER SCHRUPP-SPINDELKÖPFE
2408-M12X35	M12X1.75	18	8	7	35	A27 MONTAJ VİDASI / MOUNTING SCREW	BEFESTIGUNGSSCHRAUBE
2510-M12X35	M12X1.75	18	10	12	35	A27 MONTAJ VİDASI / MOUNTING SCREW	BEFESTIGUNGSSCHRAUBE
2514-M16X35	M16X2.0	23.7	14	16	35	A32 MONTAJ VİDASI / MOUNTING SCREW	BEFESTIGUNGSSCHRAUBE
AAV-11-U5-40x4.5	UNC 5-40	5.4	T10	2.8	4.5	16 ER/L, 16 IR/L ALTLIK VİDASI / SHIM SCREW	SCHRAUBE FÜR UNTERLAGE
AAV-12-U8-32x5.5	UNC 8-32	6.7	T20	3.8	5.5	22 ER/L, 22 IR/L ALTLIK VİDASI / SHIM SCREW	SCHRAUBE FÜR UNTERLAGE
AAV-15-M5x5.7	M5X0.8	8.5	T20	3.15	5.7	27 ER/L, 27 IR/L ALTLIK VİDASI / SHIM SCREW	SCHRAUBE FÜR UNTERLAGE

SEKMAN / RING / RING

Ürün Resmi Product Picture Produkt-Bild	Ürün Detayı / Product Detail / Produkt-Details	
		ACS-01
AS-01		T-M-SİSTEM için / For T-M-SYSTEM / FÜR T-M-SYSTEM AKV-30-M6x20 SEKMANI / RING

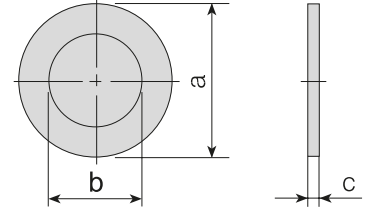
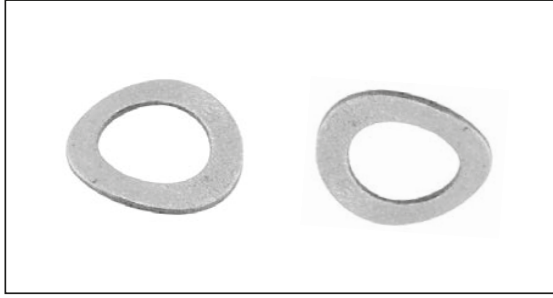

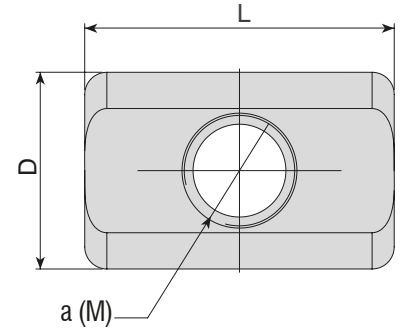

Takım Kodu Ordering Code Bestell-Bezeichnung	BASKI VE ALTLIK VİDASI PULU / STAMP / UNTERLEGSCHIEBE			Ürün Detayı / Product Detail / Produkt-Details	
	a	b	c		
ABPL-01	11	6.5	0.5	PUL/STAMP/RING	BASKI PULU / STAMP / RING
ABPL-02	12.75	7.1	0.45	PUL/STAMP/RING	BASKI PULU / STAMP / RING
ABPL-03	5.3	3.2	0.5	PUL/STAMP/RING	TER - TIR 16 ER/EL - IR/IL ALTLIK VİDA PULU / SHIM SCREW RING / SCHRAUBE FÜR UNTERLAGENRING
ABPL-04	6.9	4.2	0.5	PUL/STAMP/RING	TER - TIR 22 ER/EL - IR/IL ALTLIK VİDA PULU / SHIM SCREW RING / SCHRAUBE FÜR UNTERLAGENRING
ABPL-05	8.5	5	0.5	PUL/STAMP/RING	TER - TIR 27 ER/EL - IR/IL ALTLIK VİDA PULU / SHIM SCREW RING / SCHRAUBE FÜR UNTERLAGENRING



Takım Kodu Ordering Code Bestell-Bezeichnung	BARA PABUÇLARI / BORING HEADS CARTRIDGE / KASSETTE FÜR SPINDELKOPF			Ürün Detayı / Product Detail / Produkt-Details	
	a (M)	D	L		
ABKS-D16	M3x0.5	4.9	6	KABA BARA için / for ROUGH BORING HEADS / FÜR SCHRUPP-SPINDELKOPF	ABHR-D16x42-W16-L90
ABKS-D20	M4x0.7	5.9	9	KABA BARA için / for ROUGH BORING HEADS / FÜR SCHRUPP-SPINDELKOPF	ABHR-D20x50-W20-L100
ABKS-D25	M4x0.7	5.9	12	KABA BARA için / for ROUGH BORING HEADS / FÜR SCHRUPP-SPINDELKOPF	ABHR-D25x60-W20-L110
ABKS-D32	M5x0.8	8.9	14	KABA BARA için / for ROUGH BORING HEADS / FÜR SCHRUPP-SPINDELKOPF	ABHR-D32x64-W25-L120
ABKS-D40	M6x1	10.9	18	KABA BARA için / for ROUGH BORING HEADS / FÜR SCHRUPP-SPINDELKOPF	ABHR-D40x80-W32-L140
ABKS-D50	M8x1.25	13.9	28	KABA BARA için / for ROUGH BORING HEADS / FÜR SCHRUPP-SPINDELKOPF	ABHR-D50x100-W32-L160
ABKS-D63	M10x1.5	15.9	35	KABA BARA için / for ROUGH BORING HEADS / FÜR SCHRUPP-SPINDELKOPF	ABHR-D63x80-W32-L140, ABHR-D63x130-W40-L200
ABKS-D80	M12x1.75	17.9	45	KABA BARA için / for ROUGH BORING HEADS / FÜR SCHRUPP-SPINDELKOPF	ABHR-D80x140-W40-L210, ABHR-D80x140-W40-L210-B



Ürün Resmi Product Picture Produkt-Bild	KESME ve KANAL LAMA AÇMA BLOK PABUÇLARI / BLOCKS FOR PARTING AND DEEP GROOVING BLADES CLAMPS KLEMMLEISTE FÜR SCHWERT-SPANNBLOCK		
	Ürün Kodu Product Code / Code	Ürün Detayı / Product Detail / Produkt-Details	
	ABK-01	LAMA BLOĞU için / For BLADE BLOCK / FÜR SCHWERT-SPANNBLOCK	ALBU-20-26 BASKI PABUCU / CLAMP / PRATZE
	ABK-02	LAMA BLOĞU için / For BLADE BLOCK / FÜR SCHWERT-SPANNBLOCK	ALBU-25-26 BASKI PABUCU / CLAMP / PRATZE
	ABK-03	LAMA BLOĞU için / For BLADE BLOCK / FÜR SCHWERT-SPANNBLOCK	ALBU-20-32 BASKI PABUCU / CLAMP / PRATZE
	ABK-04	LAMA BLOĞU için / For BLADE BLOCK / FÜR SCHWERT-SPANNBLOCK	ALBU-25-32, ALBU-32-32 BASKI PABUCU / CLAMP / PRATZE

Ürün Resmi Product Picture Produkt-Bild	LAMA ANAHTARI / BLADE KEY / SCHWERT-SCHLÜSSEL	
	Ürün Kodu Product Code / Code	Ürün Detayı / Product Detail / Produkt-Details
	ALA-01	AKL LAMA ANAHTARI / for BLADE KEY / SCHWERT-SCHLÜSSEL

Ürün Resmi Product Picture Produkt-Bild	ALYAN ANAHTARLARI / ALLEN KEYS / INNENSECHSKANT-SCHLÜSSEL		
	Ürün Kodu Product Code / Code	Ürün Detayı / Product Detail / Produkt-Details	
	AAL-01-2	2 mm	ALYAN ANAHTARI / ALLEN KEYS / INNENSECHSKANT-SCHLÜSSEL
	AAL-02-2.5	2.5 mm	ALYAN ANAHTARI / ALLEN KEYS / INNENSECHSKANT-SCHLÜSSEL
	AAL-03-3	3 mm	ALYAN ANAHTARI / ALLEN KEYS / INNENSECHSKANT-SCHLÜSSEL
	AAL-05-4	4 mm	ALYAN ANAHTARI / ALLEN KEYS / INNENSECHSKANT-SCHLÜSSEL
	AAL-07-5	5 mm	ALYAN ANAHTARI / ALLEN KEYS / INNENSECHSKANT-SCHLÜSSEL
	AAL-08-6	6 mm	ALYAN ANAHTARI / ALLEN KEYS / INNENSECHSKANT-SCHLÜSSEL
	AAL-09-1.5	1.5 mm	ALYAN ANAHTARI / ALLEN KEYS / INNENSECHSKANT-SCHLÜSSEL
	AAL-11-8	8 mm	ALYAN ANAHTARI / ALLEN KEYS / INNENSECHSKANT-SCHLÜSSEL
AAL-12-10	10 mm	ALYAN ANAHTARI / ALLEN KEYS / INNENSECHSKANT-SCHLÜSSEL	

Ürün Resmi Product Picture Produkt-Bild	TORK ANAHTARLARI / TORX KEYS / TORX-SCHLÜSSEL	
	Ürün Kodu Product Code / Code	Ürün Detayı / Product Detail / Produkt-Details
	80-T06	T06 TORK ANAHTARI / TORX KEY / TORX-SCHLÜSSEL
	80-T07	T07 TORK ANAHTARI / TORX KEY / TORX-SCHLÜSSEL
	80-T08	T08 TORK ANAHTARI / TORX KEY / TORX-SCHLÜSSEL
	80-T10	T10 TORK ANAHTARI / TORX KEY / TORX-SCHLÜSSEL
	80-T15	T15 TORK ANAHTARI / TORX KEY / TORX-SCHLÜSSEL
	80-T20	T20 TORK ANAHTARI / TORX KEY / TORX-SCHLÜSSEL
	81-T15	T15 T-TİP TORK ANAHTARI / T-TYPE TORX KEY / T-TYP-TORX-SCHLÜSSEL
	81-T20	T20 T-TİP TORK ANAHTARI / T-TYPE TORX KEY / T-TYP-TORX-SCHLÜSSEL

KOD / CODE	AÇIKLAMA / DESCRIPTION	BESCHREIBUNG	S.N. / P.N. SEITE
A/SCLCR/L ..	Boring Bars SET	Bohslangen Set	112
A/SUCR/L ..	Boring Bars SET	Bohslangen Set	113
AAKT-IG-R/L ..	Face External Grooving Tool Holders	Axial Stechhalter	154
AAKT-KG-R/L ..	Face External Grooving Tool Holders	Axial Stechhalter	151
AAKT-K-R/L ..	Face External Grooving Tool Holders	Axial Stechhalter	152
AAKT-ZCC2-R/L ..	Face External Grooving Tool Holders	Axial Stechhalter	153
AAUT-T20-R/L	Corner Reliefs Grooving Toolholders	Stechwerkzeug für Freistliche	14
ABHR ..	Adjustable Rough Boring Heads	Einstellbare Schrupp-Spindelköpfe	205
ABHRS ..	Adjustable Rough Boring Heads Body	Trägerwerkzeug für einstellbare Schrupp-Spindelköpfe	206
ABT-B4..	Broaching Toolholders	Räumwerkzeug	16
ACBM ..	Countersink Open Milling Tools	Senkwerkzeug f.Zylinderkopfschrauben	213
ACM ..	Chamfering End Mills	Fasfräser	211
ACM45-SP..	Chamfering End Mills	Fasfräser	212
ACPBT-..	Pipe Beveling Tools	Rohrendenanfaswerkzeug	124
ADCR	Drill Chamfering Ring Tools	Fasring für Vollbohrer	196
ADKT-123-R/L ..	External Grooving Tool Holders	Außen - Stechhalter	142
ADKT-151.22-R/L ..	External Grooving Tool Holders	Außen - Stechhalter	143
ADKT-151.23-R/L ..	External Grooving Tool Holders	Außen - Stechhalter	143
ADKT-154.91-R/L ..	External Grooving Tool Holders	Außen - Stechhalter	144
ADKT-ARN-R/L ..	External Grooving Tool Holders	Außen - Stechhalter	144
ADKT-CD-R/L ..	External Grooving Tool Holders	Außen - Stechhalter	148
ADKT-GP-R/L ..	External Grooving Tool Holders	Außen - Stechhalter	147
ADKT-H22-R/L ..	External Grooving Tool Holders	Außen - Stechhalter	146
ADKT-HK-R/L ..	External Grooving Tool Holders	Außen - Stechhalter	138
ADKT-H-R/L ..	External Grooving Tool Holders	Außen - Stechhalter	138
ADKT-HS223-R/L ..	External Grooving Tool Holders	Außen - Stechhalter	138
ADKT-IDC-R/L ..	External Grooving Tool Holders	Außen - Stechhalter	141
ADKT-IGI-R/L ..	External Grooving Tool Holders	Außen - Stechhalter	141
ADKT-IG-R/L ..	External Grooving Tool Holders	Außen - Stechhalter	141
ADKT-IGTN-R/L ..	External Grooving Tool Holders	Außen - Stechhalter	141
ADKT-I-R/L ..	External Grooving Tool Holders	Außen - Stechhalter	141
ADKT-I-R/L ..S	External Grooving (Swiss Type) Tool Holders	Außen - Stechhalter (Swiss Type)	149
ADKT-ITG-R/L ..	External Grooving Tool Holders	Außen - Stechhalter	140
ADKT-KG-R/L ..	External Grooving Tool Holders	Außen - Stechhalter	137
ADKT-KG-R/L ..S	External Grooving (Swiss Type) Tool Holders	Außen - Stechhalter (Swiss Type)	150
ADKT-KM-R/L ..	External Grooving Tool Holders	Außen - Stechhalter	142
ADKT-K-R/L ..S	External Grooving (Swiss Type) Tool Holders	Außen - Stechhalter (Swiss Type)	150
ADKT-K-R/L ..	External Grooving Tool Holders	Außen - Stechhalter	136
ADKT-LGC-R/L ..	External Grooving Tool Holders	Außen - Stechhalter	146
ADKT-SGC-R/L ..	External Grooving Tool Holders	Außen - Stechhalter	137
ADKT-SWC-R/L ..	External Grooving Tool Holders	Außen - Stechhalter	145
ADKT-T12P-R/L	Poly-V Grooving Toolholders	Poly-V Riemennuten	12
ADKT-TD-R/L ..	External Grooving Tool Holders	Außen - Stechhalter	145
ADKT-TD-R/L ..S	External Grooving (Swiss Type) Tool Holders	Außen - Stechhalter (Swiss Type)	148
ADKT-WGX..R/L ..S	External Grooving (Swiss Type) Tool Holders	Außen - Stechhalter (Swiss Type)	151
ADKT-WGX..R/L ..	External Grooving Tool Holders	Außen - Stechhalter	147
ADKT-ZCC1-R/L ..	External Grooving Tool Holders	Außen - Stechhalter	140
ADKT-ZCC2-R/L ..	External Grooving Tool Holders	Außen - Stechhalter	139
ADKT-ZCC2-R/L ..S	External Grooving (Swiss Type) Tool Holders	Außen - Stechhalter (Swiss Type)	149
AEKR/L ..	Economic Cutting Tools	Multifunktionales Werkzeug	202
AEM90-3P..	End Mills	Schafffräser	237
AEM90-3P..	Modular End Mills	Einschraubfräser	257
AEM90-4N..	End Mills	Schafffräser	238
AEM90-AD..	End Mills	Schafffräser	214-215-216
AEM90-AD..	Modular End Mills	Einschraubfräser	253
AEM90-AN..	End Mills	Schafffräser	216-217
AEM90-AO..	End Mills	Schafffräser	223
AEM90-AO..	Modular End Mills	Einschraubfräser	252
AEM90-AP..	End Mills	Schafffräser	218-219-220-221-222-223
AEM90-AP..	Modular End Mills	Einschraubfräser	254
AEM90-AX..	End Mills	Schafffräser	224-225
AEM90-AX..	Modular End Mills	Einschraubfräser	253
AEM90-AZ..	End Mills	Schafffräser	226
AEM90-BD..	End Mills	Schafffräser	227
AEM90-DC..	Modular End Mills	Einschraubfräser	255
AEM90-ED..	End Mills	Schafffräser	228

KOD / CODE	AÇIKLAMA / DESCRIPTION	BESCHREIBUNG	S.N. / P.N. SEITE
AEM90-LN..	End Mills	Schafffräser	228-229
AEM90-R390..	End Mills	Schafffräser	230
AEM90-R390..	Modular End Mills	Einschraubfräser	256
AEM90-RT..	End Mills	Schafffräser	231
AEM90-RT..	Modular End Mills	Einschraubfräser	255
AEM90-SE..	End Mills	Schafffräser	232
AEM90-SO..	End Mills	Schafffräser	232
AEM90-SPGT..	End Mills	Schafffräser	233
AEM90-TNG..	End Mills	Schafffräser	233
AEM90-WN..	End Mills	Schafffräser	234
AEM90-WN..	Modular End Mills	Einschraubfräser	256
AEM90-XC..	End Mills	Schafffräser	235
AEM90-XD..	End Mills	Schafffräser	236
AEM90-XN..	End Mills	Schafffräser	-
AEM90-XO..	End Mills	Schafffräser	235
AEM90-ZC..	End Mills	Schafffräser	236
AEM90-ZP..	End Mills	Schafffräser	237
AEM95(C)-XD..	Modular End Mills	Einschraubfräser	257
AEMR(C)-RD..	Face and Copy End Mills	Kopier - und Schafffräser	240
AEMR-QP..	Face and Copy Mills	Kopier - und Schafffräser	241
AEMR-QP..	Modular End Mills	Einschraubfräser	261
AEMR-RC..	Modular End Mills	Einschraubfräser	258
AEMR-RD..	Modular End Mills	Einschraubfräser	260
AEMR-RP..	Face and Copy Mills	Kopier - und Schafffräser	238-239
AEMR-RP..	Modular End Mills	Einschraubfräser	258-259
AEMR-RY..	Face and Copy End Mills	Kopier - und Schafffräser	239
AEMR-RY..	Modular End Mills	Einschraubfräser	259
AET	Eccentric Adaptor For U-Drill	Exzentrischer Adapter für Vollbohrer	198
AFM42C-XD..	Face Milling	Plan und Eckmesserköpfe	276
AFM43(C)-OD..	Face Milling	Plan-und Eckmesserköpfe	276-277
AFM43(C)-OF..	Face Milling	Plan-und Eckmesserköpfe	277-313
AFM43-ON..	Face Milling	Plan-und Eckmesserköpfe	278
AFM44-ON..	Face Milling	Plan-und Eckmesserköpfe	278
AFM45(L)-HN..	Face Milling	Plan-und Eckmesserköpfe	279
AFM45(L)-SE..	Face Milling	Plan-und Eckmesserköpfe	280-281
AFM45(S)-SE	Face Milling	Plan-und Eckmesserköpfe	280
AFM45C(L)-HN..	Face Milling	Plan-und Eckmesserköpfe	313
AFM45C(L)-SN..	Face Milling	Plan-und Eckmesserköpfe	281-282-283
AFM45C-XN..	Face Milling	Plan-und Eckmesserköpfe	314
AFM45-NN..	Face Milling	Plan-und Eckmesserköpfe	279
AFM45-ON..	Face Milling	Plan-und Eckmesserköpfe	283
AFM45C-ON..	Face Milling	Plan-und Eckmesserköpfe	284
AFM45-SA..	Face Milling	Plan-und Eckmesserköpfe	282
AFM45-XN..	Face Milling	Plan-und Eckmesserköpfe	284
AFM66-PN..	Face Milling	Plan-und Eckmesserköpfe	285
AFM67-PN..	Face Milling	Plan-und Eckmesserköpfe	286
AFM75-AP..	Face Milling	Plan-und Eckmesserköpfe	286
AFM75C-SP..	Face Milling	Plan-und Eckmesserköpfe	314
AFM75-XO..	Face Milling	Plan-und Eckmesserköpfe	286
AFM88C-SN..	Face Milling	Plan-und Eckmesserköpfe	288-289-315
AFM88-SN..	Face Milling	Plan-und Eckmesserköpfe	287
AFM89-SN..	Face Milling	Plan-und Eckmesserköpfe	289
AFM90(L)-LN..	Face Milling	Plan-und Eckmesserköpfe	296-297-298-299-300
AFM90-LO..	Face Milling	Plan-und Eckmesserköpfe	299
AFM90(S)-SD..	Face Milling	Plan-und Eckmesserköpfe	302-303
AFM90-3P..	Face Milling	Plan-und Eckmesserköpfe	308
AFM90-490..	Face Milling	Plan-und Eckmesserköpfe	301
AFM90-4N..	Face Milling	Plan-und Eckmesserköpfe	308
AFM90-AD..	Face Milling	Plan-und Eckmesserköpfe	290-291
AFM90-AN..	Face Milling	Plan-und Eckmesserköpfe	291-292-293
AFM90-AO..	Face Milling	Plan-und Eckmesserköpfe	293
AFM90-AP..	Face Milling	Plan-und Eckmesserköpfe	294-295
AFM90-AX..	Face Milling	Plan-und Eckmesserköpfe	295
AFM90-BD..	Face Milling	Plan-und Eckmesserköpfe	296
AFM90C-TP..	Face Milling	Plan-und Eckmesserköpfe	315
AFM90-R290..	Face Milling	Plan-und Eckmesserköpfe	300

KOD / CODE	AÇIKLAMA / DESCRIPTION	BESCHREIBUNG	S.N. / P.N. SEITE
AFM90-R390..	Face Milling	Plan-und Eckmesserköpfe	301
AFM90-RT..	Face Milling	Plan-und Eckmesserköpfe	302
AFM90-SE..	Face Milling	Plan-und Eckmesserköpfe	303-304
AFM90-SP..	Face Milling	Plan-und Eckmesserköpfe	304
AFM90-TN..	Face Milling	Plan-und Eckmesserköpfe	305
AFM90-TP..	Face Milling	Plan-und Eckmesserköpfe	305
AFM90-WN..	Face Milling	Plan-und Eckmesserköpfe	306
AFM90-XN..	Face Milling	Plan-und Eckmesserköpfe	307
AFM90-XO..	Face Milling	Plan-und Eckmesserköpfe	307
AFMR(C)-RD..	Face and Copy Milling	Kopier - und Schafffräser	310
AFMR-QP..	Face and Copy Milling	Kopier - und Schafffräser	312
AFMR-RC..	Face and Copy Milling	Kopier - und Schafffräser	309
AFMR-RP..	Face and Copy Milling	Kopier - und Schafffräser	311
AFMR-RY..	Face and Copy Milling	Kopier - und Schafffräser	312
AHFM(C)-SD..	High Feed End Mills	Hochvorschubschafffräser	247
AHFM(C)-SD..	High Feed Milling Tools	Hochvorschubfräser	319
AHFM(C)-SD..	Modular High Feed End Mills	Hochvorschubeinschraubfräser	265
AHFM(C)-WD..	High Feed End Mills	Hochvorschubschafffräser	250-251
AHFM(C)-WD..	Modular High Feed End Mills	Hochvorschubeinschraubfräser	268-269
AHFM-BL..	High Feed End Mills	Hochvorschubschafffräser	243
AHFM-BL..	High Feed Milling Tools	Hochvorschubfräser	316
AHFM-BL..	Modular High Feed End Mills	Hochvorschubeinschraubfräser	261
AHFM-BN..	High Feed End Mills	Hochvorschubschafffräser	241
AHFM-C-JD..	High Feed End Mills	Hochvorschubschafffräser	245
AHFM-C-JD..	High Feed Milling Tools	Hochvorschubfräser	319
AHFM-C-JD..	High Feed Milling Tools	Hochvorschubfräser	318
AHFM-C-JD..	Modular High Feed End Mills	Hochvorschubeinschraubfräser	264
AHFM-C-JD..	Modular High Feed End Mills	Hochvorschubeinschraubfräser	265
AHFM-C-WD..	High Feed Milling Tools	Hochvorschubfräser	322
AHFM-ED..	Modular High Feed End Mills	Hochvorschubeinschraubfräser	262
AHFM-EN..	High Feed End Mills	Hochvorschubschafffräser	244
AHFM-EN..	High Feed Milling Tools	Hochvorschubfräser	317
AHFM-EN..	Modular High Feed End Mills	Hochvorschubeinschraubfräser	263
AHFM-EO..	High Feed End Mills	Hochvorschubschafffräser	242
AHFM-EP..	High Feed End Mills	Hochvorschubschafffräser	242
AHFM-EP..	High Feed Milling Tools	Hochvorschubfräser	317
AHFM-EP..	Modular High Feed End Mills	Hochvorschubeinschraubfräser	262
AHFM-LN..	High Feed End Mills	Hochvorschubschafffräser	245
AHFM-LN..	Modular High Feed End Mills	Hochvorschubeinschraubfräser	263
AHFM-LO..	High Feed End Mills	Hochvorschubschafffräser	246
AHFM-LO..	High Feed Milling Tools	Hochvorschubfräser	318
AHFM-LO..	Modular High Feed End Mills	Hochvorschubeinschraubfräser	264
AHFM-LP..	High Feed End Mills	Hochvorschubschafffräser	247
AHFM-SO..	High Feed End Mills	Hochvorschubschafffräser	248
AHFM-SO..	High Feed Milling Tools	Hochvorschubfräser	320
AHFM-SO..	Modular High Feed End Mills	Hochvorschubeinschraubfräser	266
AHFM-SP..	High Feed End Mills	Hochvorschubschafffräser	248
AHFM-SP..	High Feed Milling Tools	Hochvorschubfräser	321
AHFM-SP..	Modular High Feed End Mills	Hochvorschubeinschraubfräser	258
AHFM-WN..	High Feed End Mills	Hochvorschubschafffräser	251
AHFM-WN..	High Feed Milling Tools	Hochvorschubfräser	323
AHFM-WN..	Modular High Feed End Mills	Hochvorschubeinschraubfräser	269
AHFM-WO..	High Feed End Mills	Hochvorschubschafffräser	252
AHFM-YO..	High Feed End Mills	Hochvorschubschafffräser	250
AHFM-YP..	High Feed End Mills	Hochvorschubschafffräser	249
AHFM-YP..	Modular High Feed End Mills	Hochvorschubeinschraubfräser	267
AHM ..	Helix Chamfer Milling Tools	Helix-Fasfräser	212
AHM90-AP..	Helix End Mills	Wendelschafffräser	275
AIKT-MB..	Mini Grooving Tool	Mini - Stechwerkzeuge	167
AIKT-123-R/L ..	Internal Grooving Tool Holders	Innen - Stechhalter	161
AIKT-154.91-R/L ..	Internal Grooving Tool Holders	Innen - Stechhalter	161
AIKT-GP-R/L ..	Internal Grooving Tool Holders	Innen - Stechhalter	165
AIKT-HK-R/L ..	Internal Grooving Tool Holders	Innen - Stechhalter	160
AIKT-H-R/L ..	Internal Grooving Tool Holders	Innen - Stechhalter	159
AIKT-HS223-R/L ..	Internal Grooving Tool Holders	Innen - Stechhalter	160
AIKT-IGE-R/L ..	Internal Grooving Tool Holders	Innen - Stechhalter	163

KOD / CODE	AÇIKLAMA / DESCRIPTION	BESCHREIBUNG	S.N. / P.N. SEITE
AIKT-IGI-R/L ..	Internal Grooving Tool Holders	Innen - Stechhalter	163
AIKT-IG-R/L ..	Internal Grooving Tool Holders	Innen - Stechhalter	164
AIKT-I-R/L ..	Internal Grooving Tool Holders	Innen - Stechhalter	164
AIKT-ITG-R/L ..	Internal Grooving Tool Holders	Innen - Stechhalter	165
AIKT-KG-R/L ..	Internal Grooving Tool Holders	Innen - Stechhalter	159
AIKT-KM-R/L ..	Internal Grooving Tool Holders	Innen - Stechhalter	160
AIKT-K-R/L ..	Internal Grooving Tool Holders	Innen - Stechhalter	158
AIKT-QC..-R/L ..	Internal Grooving Tool Holders	Innen - Stechhalter	166
AIKT-SGC-R ..	Internal Grooving Tool Holders	Innen - Stechhalter	166
AIKT-TD-R/L ..	Internal Grooving Tool Holders	Innen - Stechhalter	162
AIKT-ZCC2-R/L ..	Internal Grooving Tool Holders	Innen - Stechhalter	162
AKCR ..	Adjustable Rough Boring Heads Cartridge	Einstellbare Schrupp - Spindelkopf Kurzdrehhalter	207
AKL-123 ..	Blades	Stechschwert	157
AKL-I ..	Blades	Stechschwert	156
AKL-SGC ..	Blades	Stechschwert	155
AKL-TD ..	Blades	Stechschwert	156
AKSR ..	Adjustable Rough Boring Heads Cartridge	Einstellbare Schrupp - Spindelkopf Kurzdrehhalter	207
ALBU ..	Blocks For Blades	Spannblock für Stechschwert	157
ALKT-ZCC2-R/L ..	Face External Grooving Tool Holders	Axial-Stechhalter L-Type	155
APMR-BNM..	Ball Nose End Mills	Kopier-Schafffräser	270
APMR-P32..	Ball Nose End Mills	Kopier-Schafffräser	271
APMR-P32..	Ball Nose Modular End Mills	Modulare Einschraub - Kugelfräser	272
APMR-RO..	Ball Nose End Mills	Kopier-Schafffräser	270
APMR-SWB..	Ball Nose Modular End Mills	Modulare Einschraub - Kugelfräser	272
APMR-XP..	Ball Nose End Mills	Kopier-Schafffräser	271
APMR-XP..	Ball Nose Modular End Mills	Modulare Einschraub - Kugelfräser	273
ASDM-CC..	Disc Milling	Scheibenfräser	327
ASDM-SPGT..	Disc Milling	Scheibenfräser	326
ASTB..	Swiss Easy Change Tools	Swiss Easy Change Tools	75
ATM..	Thread Milling Tools	Gewindefräswerkzeuge	274
ATM60..	Thread Milling Tools	Gewindefräswerkzeuge	275
ATSM90-CC..	T Slot Milling	T Nutenfräser	324
ATSM90-SP..	T Slot Milling	T Nutenfräser	325
ATSMR-RD..	T Slot Milling	T Nutenfräser	325
ATUM .. xD2 KDR ..	U-Drill	Vollbohrer	189
ATUM .. xD2 SP ..	U-Drill	Vollbohrer	178-179
ATUM .. xD2 SPGT ..	U-Drill	Vollbohrer	183
ATUM .. xD2 WCM ..	U-Drill	Vollbohrer	172-173
ATUM .. xD3 KDR ..	U-Drill	Vollbohrer	190
ATUM .. xD3 SO ..	U-Drill	Vollbohrer	187
ATUM .. xD3 SP ..	U-Drill	Vollbohrer	180-181
ATUM .. xD3 SPGT ..	U-Drill	Vollbohrer	184-185
ATUM .. xD3 WCM ..	U-Drill	Vollbohrer	174-175
ATUM .. xD4 KDR ..	U-Drill	Vollbohrer	189
ATUM .. xD4 SO ..	U-Drill	Vollbohrer	188
ATUM .. xD4 SP ..	U-Drill	Vollbohrer	182
ATUM .. xD4 SPGT ..	U-Drill	Vollbohrer	186
ATUM .. xD4 WCM ..	U-Drill	Vollbohrer	176-177
ATUM xD2 SOMT ..	U-Drill	Vollbohrer	
ATUM xD3 SOMT ..	U-Drill	Vollbohrer	192
ATUM xD4 SOMT ..	U-Drill	Vollbohrer	193
ATUM xD5 SOMT ..	U-Drill	Vollbohrer	194
ATUM xD3 880 ..	U-Drill	Vollbohrer	195
ATW..	Whirling Toolholders	Wirbelnde Werkzeughalter	25
AVTT..	Screwed Tool Holders	Aufnahme für Einschraubfräser	273
B11..	Valve Seat Inserts	Wendeplatten für Ventilsitzbearbeitung	22-23
B41.. - B42..	Broaching Inserts	Wendplatten für Nutbearbeitung	16-17-18
CCLNR/L ..	External Tool Holders	Außen-Drehhalter	53
CDJNR/L ..	External Tool Holders	Außen-Drehhalter	53
CDNNN ..	External Tool Holders	Außen-Drehhalter	54
CKJNR/L ..	External Tool Holders	Außen-Drehhalter	52
CKUNR/L ..	Internal Tool Holders	Außen-Drehhalter	86
CRDCN ..	External Tool Holders	Außen-Drehhalter	54
CRDCR/L ..	External Tool Holders	Außen-Drehhalter	55
CSDNN ..	External Tool Holders	Außen-Drehhalter	55
CSKNR/L ..	External Tool Holders	Außen-Drehhalter	56

KOD / CODE	AÇIKLAMA / DESCRIPTION	BESCHREIBUNG	S.N. / P.N. SEITE	KOD / CODE	AÇIKLAMA / DESCRIPTION	BESCHREIBUNG	S.N. / P.N. SEITE
CSNR/L ..	External Tool Holders	Außen-Drehhalter	56	SDUCR/L ..	Boring Bars With Carbide Shank	Bohrslangen mit Hartmetallschaft	111
CSSNR/L ..	External Tool Holders	Außen-Drehhalter	57	SDUCR/L ..	Internal Tool Holders	Innen-Drehhalter	102
CTJNR/L ..	External Tool Holders	Außen-Drehhalter	57	SDXCR/L ..	Internal Tool Holders	Innen-Drehhalter	103
E/SCLCR/L ..	Boring Bars SET	Bohrslangen Set	112	SER/L ..	External Threading Tool Holders	Werkzeughalter für Außengewinde	128
E/SDUCR/L ..	Boring Bars SET	Bohrslangen Set	113	SIR/L ..	Internal Threading Tool Holders	Werkzeughalter für Innengewinde	129
MCLNR/L ..	Internal Tool Holders	Innen-Drehhalter	88	SRDCN ..	External Tool Holders	Außen-Drehhalter	62
MDUNR/L ..	Internal Tool Holders	Innen-Drehhalter	88	SRDCR/L ..	External Tool Holders	Außen-Drehhalter	63
MTENN ..	External Tool Holders	Außen-Drehhalter	41	SRGCR/L ..	External Tool Holders	Außen-Drehhalter	63
MTFNR/L ..	Internal Tool Holders	Innen-Drehhalter	89	SRGCR/L ..	Internal Tool Holders	Innen-Drehhalter	103
MTJNR/L ..	External Tool Holders	Außen-Drehhalter	41	SRHCR/L ..	External Tool Holders	Außen-Drehhalter	64
MT-NR/L ..	Internal Tool Holders	Innen-Drehhalter	89	SRSCN..	Engine Overhaul Cartridge	Motorüberholungskassette	117
MTQNR/L ..	Internal Tool Holders	Innen-Drehhalter	90	SRXCR/L ..	External Tool Holders	Außen-Drehhalter	64
MTUNR/L ..	Internal Tool Holders	Innen-Drehhalter	90	SSDCN ..	External Tool Holders	Außen-Drehhalter	65
MWLNR/L ..	External Tool Holders	Außen-Drehhalter	42	SSKCR/L ..	Cartridge	Kassette	119
MWLNR/L ..	Internal Tool Holders	Innen-Drehhalter	91	SSSCR/L ..	External Tool Holders	Außen-Drehhalter	65
MWMNN ..	External Tool Holders	Außen-Drehhalter	42	SSSCR/L ..	Internal Tool Holders	Innen-Drehhalter	104
PCBNR/L ..	External Tool Holders	Außen-Drehhalter	44	STCCN ..	External Tool Holders	Außen-Drehhalter	67
PCLNR/L ..	External Tool Holders	Außen-Drehhalter	44	ST-CR/L ..	Internal Tool Holders	Innen-Drehhalter	104
PCLNR/L ..	Internal Tool Holders	Innen-Drehhalter	93	STFCR/L	Spare Parts Of Cartridge	Ersatzteile für Kassette	123
PCMNN ..	External Tool Holders	Außen-Drehhalter	45	STFCR/L ..	Cartridge	Kassette	120
PDJNR/L ..	External Tool Holders	Außen-Drehhalter	45	STFCR/L ..	External Tool Holders	Außen-Drehhalter	66
PDNNN ..	External Tool Holders	Außen-Drehhalter	46	STFCR/L ..	Internal Tool Holders	Innen-Drehhalter	105
PDQNR/L ..	Internal Tool Holders	Innen-Drehhalter	94	STGCR/L ..	External Tool Holders	Außen-Drehhalter	66
PDUNR/L ..	Internal Tool Holders	Innen-Drehhalter	95	STGCR/L ..-S	External Tool Holders Swiss Type	Außen-Drehhalter Swiss Type	73
PDXNR/L ..	Internal Tool Holders	Innen-Drehhalter	94	STJCR/L ..	External Tool Holders	Außen-Drehhalter	67
PSBNR/L ..	External Tool Holders	Außen-Drehhalter	46	STSCR/L	Spare Parts Of Cartridge	Ersatzteile für Kassette	123
PSDNN ..	Cartridge	Kassette	123	STSCR/L ..	Cartridge	Kassette	120
PSDNN ..	External Tool Holders	Außen-Drehhalter	47	STTCR/L	Spare Parts Of Cartridge	Ersatzteile für Kassette	123
PSKNR/L ..	Cartridge	Kassette	121	STTCR/L ..	Cartridge	Kassette	121
PSKNR/L ..	External Tool Holders	Außen-Drehhalter	47	STUCR/L ..	External Tool Holders	Außen-Drehhalter	68
PSKNR/L ..	Internal Tool Holders	Innen-Drehhalter	95	STUCR/L ..	Internal Tool Holders	Innen-Drehhalter	105
PSRNR/L ..	Cartridge	Kassette	121	STUPR/L ..	Internal Tool Holders	Innen-Drehhalter	106
PSSNR/L ..	External Tool Holders	Außen-Drehhalter	48	STXCR/L ..	Engine Overhaul Cartridge	Motorüberholungskassette	118
PTFNR/L ..	Cartridge	Kassette	122	SVACR/L ..-S	External Tool Holders Swiss Type	Außen-Drehhalter Swiss Type	74
PTFNR/L ..	External Tool Holders	Außen-Drehhalter	48	SVHBR/L ..	External Tool Holders	Außen-Drehhalter	68
PTGNR/L ..	External Tool Holders	Außen-Drehhalter	49	SVHCR/L ..	External Tool Holders	Außen-Drehhalter	69
PTJNR/L ..	External Tool Holders	Außen-Drehhalter	49	SVJBR/L ..	External Tool Holders	Außen-Drehhalter	69
PTTNR/L ..	External Tool Holders	Außen-Drehhalter	50	SVJBR/L ..	Internal Tool Holders	Innen-Drehhalter	106
PTUNR/L ..	Internal Tool Holders	Innen-Drehhalter	96	SVJBR/L ..-S	External Tool Holders Swiss Type	Außen-Drehhalter Swiss Type	74
PWLNR/L ..	External Tool Holders	Außen-Drehhalter	50	SVJCR/L ..	External Tool Holders	Außen-Drehhalter	70
PWLNR/L ..	Internal Tool Holders	Innen-Drehhalter	97	SVJCR/L ..	Internal Tool Holders	Innen-Drehhalter	109
S/SCLCR/L ..	Boring Bars SET	Bohrslangen Set	112	SVJCR/L ..-S	External Tool Holders Swiss Type	Außen-Drehhalter Swiss Type	75
S/SDUCR/L ..	Boring Bars SET	Bohrslangen Set	113	SVJCR/L	Swiss Easy Change Tools	Swiss Easy Change Tools	76
SCACR/L ..	Engine Overhaul Cartridge	Motorüberholungskassette	116	SVQBR/L ..	Internal Tool Holders	Innen-Drehhalter	107
SCACR/L ..	External Tool Holders	Außen-Drehhalter	59	SVQCR/L ..	Internal Tool Holders	Innen-Drehhalter	107
SCACR/L ..-S	External Tool Holders Swiss Type	Außen-Drehhalter Swiss Type	71	SVUBR/L ..	Internal Tool Holders	Innen-Drehhalter	108
SCFCR/L	Spare Parts Of Cartridge	Ersatzteile für Kassette	123	SVUCR/L ..	Internal Tool Holders	Innen-Drehhalter	108
SCFCR/L ..	Cartridge	Kassette	118	SVVBN ..	External Tool Holders	Außen-Drehhalter	70
SCFCR/L ..	Internal Tool Holders	Innen-Drehhalter	100	SVVCN ..	External Tool Holders	Außen-Drehhalter	71
SCLCR/L ..	Boring Bars With Carbide Shank	Bohrslangen mit Hartmetallschaft	111	SVXBR/L ..	Internal Tool Holders	Innen-Drehhalter	109
SCLCR/L ..	External Tool Holders	Außen-Drehhalter	59	SWLCR ..	Internal Tool Holders	Innen-Drehhalter	110
SCLCR/L ..	Internal Tool Holders	Innen-Drehhalter	99	SWUBR ..	Internal Tool Holders	Innen-Drehhalter	110
SCLCR/L ..-S	External Tool Holders Swiss Type	Außen-Drehhalter Swiss Type	72	T09..	Whirling Inserts	Gewindewirbelplatte	26
SCMCN ..	Engine Overhaul Cartridge	Motorüberholungskassette	117	T12.10	Poly-V Grooving Inserts	Poly-V Riemennuten	12
SCMCN ..	External Tool Holders	Außen-Drehhalter	60	T20	Corner Reliefs Grooving Inserts	Eckreliefs Einstechplatten	14
SCSCR/L	Spare Parts Of Cartridge	Ersatzteile für Kassette	123	TCBNR/L ..	External Tool Holders	Außen-Drehhalter	31
SCSCR/L ..	Cartridge	Kassette	119	TCKNR/L ..	External Tool Holders	Außen-Drehhalter	31
SDACR/L ..-S	External Tool Holders Swiss Type	Außen-Drehhalter Swiss Type	72	TCLNR/L ..	External Tool Holders	Außen-Drehhalter	32
SD-CR/L ..	Internal Tool Holders	Innen-Drehhalter	100	TCLNR/L ..	Internal Tool Holders	Innen-Drehhalter	82
SDHCR/L ..	External Tool Holders	Außen-Drehhalter	60	TCMNN ..	External Tool Holders	Außen-Drehhalter	32
SDJCR/L ..	External Tool Holders	Außen-Drehhalter	61	TCZNN ..	External Tool Holders	Außen-Drehhalter	33
SDJCR/L ..-S	External Tool Holders Swiss Type	Außen-Drehhalter Swiss Type	73	TDHNR/L ..	External Tool Holders	Außen-Drehhalter	33
SDJCR/L-..	Swiss Easy Change Tools	Swiss Easy Change Tools	76	TDJNR/L ..	External Tool Holders	Außen-Drehhalter	34
SDNCN ..	External Tool Holders	Außen-Drehhalter	61	TDNNN ..	External Tool Holders	Außen-Drehhalter	34
SDPCR/L ..	Internal Tool Holders	Innen-Drehhalter	101	TD-NR/L ..	Internal Tool Holders	Innen-Drehhalter	82
SDQCR/L ..	Internal Tool Holders	Innen-Drehhalter	101	TDQNR/L ..	Internal Tool Holders	Innen-Drehhalter	83

KOD / CODE	AÇIKLAMA / DESCRIPTION	BESCHREIBUNG	S.N. / P.N. SEITE
TDUNR/L ..	Internal Tool Holders	Innen-Drehhalter	83
TER/L ..	External Threading Tool Holders	Werkzeughalter für Außengewinde	130
TIR/L ..	Internal Threading Tool Holders	Werkzeughalter für Innengewinde	131
TSDNN ..	External Tool Holders	Außen-Drehhalter	35
TSKNR/L ..	External Tool Holders	Außen-Drehhalter	35
TSKNR/L ..	Internal Tool Holders	Innen-Drehhalter	84
TSSNR/L ..	External Tool Holders	Außen-Drehhalter	36
TTENN ..	External Tool Holders	Außen-Drehhalter	36
TTGNR/L ..	External Tool Holders	Außen-Drehhalter	37
TTJNR/L ..	External Tool Holders	Außen-Drehhalter	37
TT-NR/L ..	Internal Tool Holders	Innen-Drehhalter	84
TTUNR/L ..	Internal Tool Holders	Innen-Drehhalter	85
TVHNR/L ..	External Tool Holders	Außen-Drehhalter	38
TVJNR/L ..	External Tool Holders	Außen-Drehhalter	38
TVUNR/L ..	Internal Tool Holders	Innen-Drehhalter	85
TVVNN ..	External Tool Holders	Außen-Drehhalter	39
TWLNRL ..	External Tool Holders	Außen-Drehhalter	39
TWLNRL ..	Internal Tool Holders	Innen-Drehhalter	86
VST-B11..	Valve Seat Toolholders	Werkzeuge für Ventilsitzbearbeitung	21-22
1008-..	Spare Parts	Ersatzteile	342-343
1015-..	Spare Parts	Ersatzteile	342-343
1020-..	Spare Parts	Ersatzteile	342-343
1108-..	Spare Parts	Ersatzteile	342-343
1120-..	Spare Parts	Ersatzteile	342-343
1204-..	Spare Parts	Ersatzteile	342-343
1208-..	Spare Parts	Ersatzteile	341
1210-..	Spare Parts	Ersatzteile	341
1215-..	Spare Parts	Ersatzteile	341
1220-..	Spare Parts	Ersatzteile	341
1315-..	Spare Parts	Ersatzteile	342-343
1415-..	Spare Parts	Ersatzteile	342-343
1420-..	Spare Parts	Ersatzteile	342-343
1510-..	Spare Parts	Ersatzteile	342-343
1515-..	Spare Parts	Ersatzteile	342-343
1520-..	Spare Parts	Ersatzteile	342-343
1615-..	Spare Parts	Ersatzteile	342-343
1620-..	Spare Parts	Ersatzteile	342-343
1707-..	Spare Parts	Ersatzteile	342-343
1710-..	Spare Parts	Ersatzteile	342-343
1720-..	Spare Parts	Ersatzteile	342-343
1904-..	Spare Parts	Ersatzteile	339
2004-..	Spare Parts	Ersatzteile	339
2405-..	Spare Parts	Ersatzteile	345
2406-..	Spare Parts	Ersatzteile	345
2407-..	Spare Parts	Ersatzteile	345
2408-..	Spare Parts	Ersatzteile	345
2503-..	Spare Parts	Ersatzteile	345
2504-..	Spare Parts	Ersatzteile	345
2505-..	Spare Parts	Ersatzteile	345
2506-..	Spare Parts	Ersatzteile	345
2508-..	Spare Parts	Ersatzteile	345
2510-..	Spare Parts	Ersatzteile	345
2514-..	Spare Parts	Ersatzteile	345
2525-..	Spare Parts	Ersatzteile	345
2600-..	Spare Parts	Ersatzteile	344
2702-..	Spare Parts	Ersatzteile	344
2703-..	Spare Parts	Ersatzteile	344
2704-..	Spare Parts	Ersatzteile	344
2715-..	Spare Parts	Ersatzteile	344
2725-..	Spare Parts	Ersatzteile	344
3006-..	Spare Parts	Ersatzteile	342-343
3007-..	Spare Parts	Ersatzteile	342-343
3008-..	Spare Parts	Ersatzteile	342-343
3010-..	Spare Parts	Ersatzteile	342-343
3015-..	Spare Parts	Ersatzteile	342-343
3108-..	Spare Parts	Ersatzteile	342-343

KOD / CODE	AÇIKLAMA / DESCRIPTION	BESCHREIBUNG	S.N. / P.N. SEITE
4006-..	Spare Parts	Ersatzteile	342-343
4008-..	Spare Parts	Ersatzteile	342-343
4010-..	Spare Parts	Ersatzteile	342-343
4015-..	Spare Parts	Ersatzteile	342-343
4020-..	Spare Parts	Ersatzteile	342-343
4420-..	Spare Parts	Ersatzteile	342-343
4615-..	Spare Parts	Ersatzteile	342-343
80-..	Spare Parts	Ersatzteile	347
81-..	Spare Parts	Ersatzteile	347
AACN-..	Spare Parts	Ersatzteile	334
AADN-..	Spare Parts	Ersatzteile	334
AAL-..	Spare Parts	Ersatzteile	347
AARC-..	Spare Parts	Ersatzteile	334
AASD-..	Spare Parts	Ersatzteile	334
AASE-..	Spare Parts	Ersatzteile	334
AASN-..	Spare Parts	Ersatzteile	334
AATN-..	Spare Parts	Ersatzteile	334
AAV-..	Spare Parts	Ersatzteile	336-337
AAVN-..	Spare Parts	Ersatzteile	334
AAWN-..	Spare Parts	Ersatzteile	334
AAV-..	Spare Parts	Ersatzteile	340
ABK-..	Spare Parts	Ersatzteile	347
ABKS-..	Spare Parts	Ersatzteile	346
ABPL-..	Spare Parts	Ersatzteile	346
ACK-..	Spare Parts	Ersatzteile	335
ACS-..	Spare Parts	Ersatzteile	345
AS-01	Spare Parts	Ersatzteile	345
AEV-..	Spare Parts	Ersatzteile	341
AKS-..	Spare Parts	Ersatzteile	334
AKV-..	Spare Parts	Ersatzteile	336-338-339
AKY-..	Spare Parts	Ersatzteile	338
ALA-..	Spare Parts	Ersatzteile	347
ALV-..	Spare Parts	Ersatzteile	339
AMK-..	Spare Parts	Ersatzteile	335
APL-..	Spare Parts	Ersatzteile	339
APM-..	Spare Parts	Ersatzteile	340
ATK-..	Spare Parts	Ersatzteile	335
ATS-..	Spare Parts	Ersatzteile	334



konusulan
the spoken *kalite...*
quality...



www.akko.com.tr



Codes and photographs in this catalog can not be used, copied or published in any digital place without permission. AKKO reserves the right to make changes on products, codes and specifications.

Bezeichnungen und Fotos aus diesem Katalog dürfen nicht ohne Genehmigung digital veröffentlicht werden. Akko behält sich das Recht vor, Änderungen an Produkten, Bezeichnungen und Spezifikationen vorzunehmen.



KATALOĞU
CATALOGUE



17. VERSİYON
VERSION



MAKİNA TAKİM SAN. TİC. LTD. ŞTİ.

Konya Organize Sanayi Bölgesi
Işıktepe Sk. No:6 P.K. 42250
Selçuklu / KONYA / TÜRKİYE

Tel : +90 332 239 17 57 (pbx)
Fax: +90 332 239 17 52
GPS: 37.973262 N / 32.604158 E

www.akko.com.tr
akko@akko.com.tr
export@akko.com.tr

